

**ASUS®**

**VG28UQL1A Series  
LCD Monitor**

**User Guide**

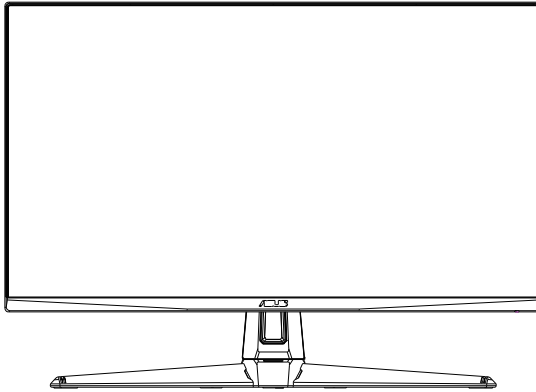

**HDMI™**  
HIGH-DEFINITION MULTIMEDIA INTERFACE

# Table of contents

- Notices ..... iii
- Safety information ..... iv
- Care & Cleaning ..... vi
- 1.1 Welcome! ..... 1-1
- 1.2 Package contents..... 1-1
- 1.3 Assembling the monitor ..... 1-2
- 1.4 Connect cables..... 1-3
  - 1.4.1 Rear of the LCD monitor..... 1-3
- 1.5 Monitor introduction ..... 1-4
  - 1.5.1 Using the Controls button ..... 1-4
- 2.1 Adjusting the monitor..... 2-1
- 2.2 Detaching the arm/stand (for VESA wall mount) ..... 2-2
- 2.3 Outline dimension..... 2-3
- 3.1 OSD (On-Screen Display) menu ..... 3-1
  - 3.1.1 How to reconfigure ..... 3-1
  - 3.1.2 OSD Function Introduction ..... 3-2
- 3.2 Specifications..... 3-8
- 3.3 Troubleshooting (FAQ)..... 3-9
- 3.4 Supported Timing List..... 3-10

Copyright © 2019 ASUSTeK COMPUTER INC. All Rights Reserved.

No part of this manual, including the products and software described in it, may be reproduced, transmitted, transcribed, stored in a retrieval system, or translated into any language in any form or by any means, except documentation kept by the purchaser for backup purposes, without the express written permission of ASUSTeK COMPUTER INC. (“ASUS”).

Product warranty or service will not be extended if: (1) the product is repaired, modified or altered, unless such repair, modification of alteration is authorized in writing by ASUS; or (2) the serial number of the product is defaced or missing.

ASUS PROVIDES THIS MANUAL “AS IS” WITHOUT WARRANTY OF ANY KIND, EITHER EXPRESS OR IMPLIED, INCLUDING BUT NOT LIMITED TO THE IMPLIED WARRANTIES OR CONDITIONS OF MERCHANTABILITY OR FITNESS FOR A PARTICULAR PURPOSE. IN NO EVENT SHALL ASUS, ITS DIRECTORS, OFFICERS, EMPLOYEES OR AGENTS BE LIABLE FOR ANY INDIRECT, SPECIAL, INCIDENTAL, OR CONSEQUENTIAL DAMAGES (INCLUDING DAMAGES FOR LOSS OF PROFITS, LOSS OF BUSINESS, LOSS OF USE OR DATA, INTERRUPTION OF BUSINESS AND THE LIKE), EVEN IF ASUS HAS BEEN ADVISED OF THE POSSIBILITY OF SUCH DAMAGES ARISING FROM ANY DEFECT OR ERROR IN THIS MANUAL OR PRODUCT.

SPECIFICATIONS AND INFORMATION CONTAINED IN THIS MANUAL ARE FURNISHED FOR INFORMATIONAL USE ONLY, AND ARE SUBJECT TO CHANGE AT ANY TIME WITHOUT NOTICE, AND SHOULD NOT BE CONSTRUED AS A COMMITMENT BY ASUS. ASUS ASSUMES NO RESPONSIBILITY OR LIABILITY FOR ANY ERRORS OR INACCURACIES THAT MAY APPEAR IN THIS MANUAL, INCLUDING THE PRODUCTS AND SOFTWARE DESCRIBED IN IT.

Products and corporate names appearing in this manual may or may not be registered trademarks or copyrights of their respective companies, and are used only for identification or explanation and to the owners' benefit, without intent to infringe.

# Notices

## Federal Communications Commission Statement

This device complies with Part 15 of the FCC Rules. Operation is subject to the following two conditions:

- This device may not cause harmful interference, and
- This device must accept any interference received including interference that may cause undesired operation.

This equipment has been tested and found to comply with the limits for a Class B digital device, pursuant to Part 15 of the FCC Rules. These limits are designed to provide reasonable protection against harmful interference in a residential installation. This equipment generates, uses and can radiate radio frequency energy and, if not installed and used in accordance with manufacturer's instructions, may cause harmful interference to radio communications. However, there is no guarantee that interference will not occur in a particular installation. If this equipment does cause harmful interference to radio or television reception, which can be determined by turning the equipment off and on, the user is encouraged to try to correct the interference by one or more of the following measures:

- Reorient or relocate the receiving antenna.
- Increase the separation between the equipment and receiver.
- Connect the equipment to an outlet on a circuit different from that to which the receiver is connected.
- Consult the dealer or an experienced radio/TV technician for help.

## Canadian Department of Communications Statement

This digital apparatus does not exceed the Class B limits for radio noise emissions from digital apparatus set out in the Radio Interference Regulations of the Canadian Department of Communications.

This class B digital apparatus complies with Canadian ICES-003.



## Safety information

- Before setting up the monitor, carefully read all the documentation that came with the package.
- To prevent fire or shock hazard, never expose the monitor to rain or moisture.
- Never try to open the monitor cabinet. The dangerous high voltages inside the monitor may result in serious physical injury.
- If the power supply is broken, do not try to fix it by yourself. Contact a qualified service technician or your retailer.
- Before using the product, make sure all cables are correctly connected and the power cables are not damaged. If you detect any damage, contact your dealer immediately.
- Slots and openings on the back or top of the cabinet are provided for ventilation. Do not block these slots. Never place this product near or over a radiator or heat source unless proper ventilation is provided.
- The monitor should be operated only from the type of power source indicated on the label. If you are not sure of the type of power supply to your home, consult your dealer or local power company.
- Use the appropriate power plug which complies with your local power standard.
- Do not overload power strips and extension cords. Overloading can result in fire or electric shock.
- Avoid dust, humidity, and temperature extremes. Do not place the monitor in any area where it may become wet. Place the monitor on a stable surface.
- Unplug the unit during a lightning storm or if it will not be used for a long period of time. This will protect the monitor from damage due to power surges.
- Never push objects or spill liquid of any kind into the slots on the monitor cabinet.
- To ensure satisfactory operation, use the monitor only with UL listed computers which have appropriate configured receptacles marked between 100 ~ 240V AC.
- The socket-outlet shall be installed near the equipment and shall be easily accessible
- If you encounter technical problems with the monitor, contact a qualified service technician or your retailer.
- Provide an earthing connection before the mains plug is connected to the mains. And, when disconnecting the earthing connection, be sure to disconnect after pulling out the mains plug from the mains.

## **WARNING**

Usage of other than specified head- or earphones can result in hearing loss due to excessive sound pressures.

Please confirm the distribution system in building installation shall provide the circuit breaker rated 120/240V, 20A (maximum).

If provided with a 3-pin attachment plug on the power cord, plug the cord into a grounded (earthed) 3-pin outlet. Do not disable the power cord grounding pin, for example, by attaching a 2-pin adapter. The grounding pin is an important safety feature.

**Declaration of Conformity** This device complies with the requirements set out in the Council Directive on the Approximation of the Laws of the Member States relating to Electromagnetic Compatibility (2014/30/EU), Low-voltage Directive (2014/35/EU), ErP Directive (2009/125/EC) and RoHS directive (2011/65/EU). This product has been tested and found to comply with the harmonized standards for Information Technology Equipment, these harmonized standards published under Directives of Official Journal of the European Union.

## Care & Cleaning

- Before you lift or reposition your monitor, it is better to disconnect the cables and power cord. Follow the correct lifting techniques when positioning the monitor. When lifting or carrying the monitor, grasp the edges of the monitor. Do not lift the display by the stand or the cord.
- Cleaning. Turn your monitor off and unplug the power cord. Clean the monitor surface with a lint-free, non-abrasive cloth. Stubborn stains may be removed with a cloth dampened with mild cleaner.
- Avoid using a cleaner containing alcohol or acetone. Use a cleaner intended for use with the LCD. Never spray cleaner directly on the screen, as it may drip inside the monitor and cause an electric shock.

### The following symptoms are normal with the monitor:

- The screen may flicker during the initial use due to the nature of the fluorescent light. Turn off the Power Switch and turn it on again to make sure that the flicker disappears.
- You may find slightly uneven brightness on the screen depending on the desktop pattern you use.
- When the same image is displayed for hours, an afterimage of the previous screen may remain after switching the image. The screen will recover slowly or you can turn off the Power Switch for hours.
- When the screen becomes black or flashes, or cannot work anymore, contact your dealer or service center to fix it. Do not repair the screen by yourself!

### Conventions used in this guide



**WARNING:** Information to prevent injury to yourself when trying to complete a task.



**CAUTION:** Information to prevent damage to the components when trying to complete a task.



**IMPORTANT:** Information that you **MUST** follow to complete a task.



**NOTE:** Tips and additional information to aid in completing a task.

## Where to find more information

Refer to the following sources for additional information and for product and software updates.

1. ASUS websites

The ASUS websites worldwide provide updated information on ASUS hardware and software products. Refer to <http://www.asus.com>

2. Optional documentation

Your product package may include optional documentation that may have been added by your dealer. These documents are not part of the standard package.

## Restriction on Hazardous Substances statement (India)

This product complies with the “India E-Waste (Management) Rules, 2016” and prohibits use of Lead, Mercury, Hexavalent Chromium, polybrominated biphenyls(PBBs) and polybrominated diphenyl ethers(PBDEs) in concentration exceeding 0.1% by weight in homogenous materials and 0.01% by weight in homogenous materials for cadmium, except of exemptions listed in Schedule 2 of the Rule.



### Disposal of waste equipment by user in private household in the European Union

This symbol on the product or on its packaging indicates that this product must not be disposed of with your other household waste. Instead, it is your responsibility to dispose of your waste equipment by handing it over to a designated collection point for the recycling of waste electrical and electronic equipment. The separate collection and recycling of your waste equipment at the time of disposal will help to conserve natural resources and ensure that it is recycled in a manner that protects human health and the environment. For more information about where you can drop off your waste equipment for recycling, please contact your local city office, your household waste disposal service or the shop where you purchased the product.

## 1.1 Welcome!

Thank you for purchasing the ASUS® LCD monitor!

The latest widescreen LCD monitor from ASUS provides a crisper, broader, and brighter display, plus a host of features that enhance your viewing experience.

With these features, you can enjoy the convenience and delightful visual experience that the monitor brings you!

## 1.2 Package contents

Check your package for the following items:

- ✓ LCD Monitor
- ✓ Quick Start Guide
- ✓ Warranty Card
- ✓ 1x Power Adapter
- ✓ 1x DisplayPort Cable (optional)
- ✓ 1x HDMI Cable (optional)
- ✓ 1x USB3.0 Cable (optional)



- 
- If any of the above items is damaged or missing, contact your retailer immediately.
-



## 1.3 Assembling the monitor

### To assemble the monitor:

---



- While assembling the monitor arm/base, we recommend that you keep the monitor inside its EPS (Expanded Polystyrene) packaging.
- 

1. Align the screw hole on the arm with the bundled screw on the base. Then insert the base into the arm.
2. Fix the base to the arm by fastening the bundled screw.

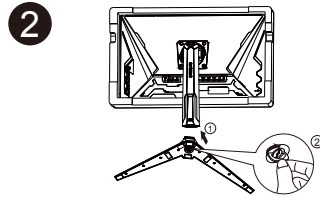
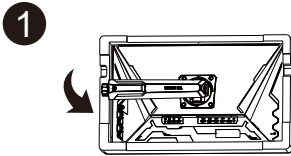

## 1.4 Connect cables

### 1.4.1 Rear of the LCD monitor

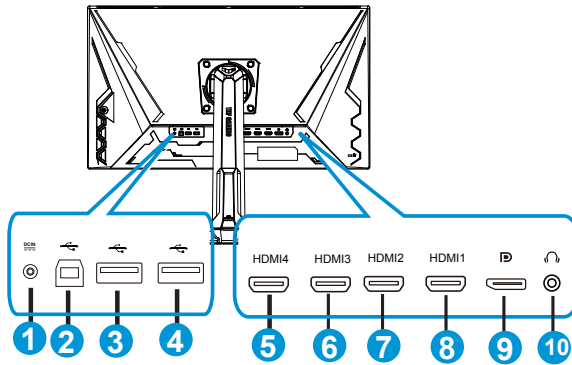

1. DC-IN Port
2. USB Upstream Port
3. USB Downstream Port
4. USB Downstream Port
5. HDMI-4 (V2.0)
6. HDMI-3 (V2.0)
7. HDMI-2 (V2.1)
8. HDMI-1 (V2.1)
9. DisplayPort
10. Earphone - out Port

## 1.5 Monitor introduction

### 1.5.1 Using the Controls button

Use the control button on the bottom of the monitor to adjust the image settings.

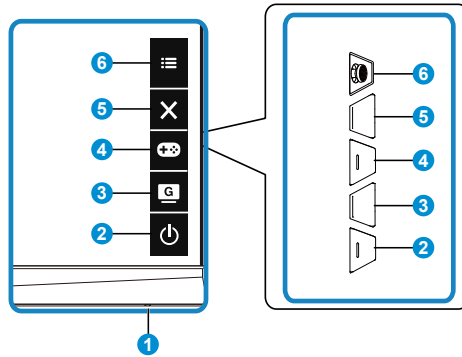

#### 1. Power Indicator:

- The color definition of the power indicator is as the below table.

Status	Description
White	ON
Amber	Standby mode
OFF	OFF

#### 2. Power Button:







- Press this button to turn the monitor on/off.



#### 3. GameVisual:



- Press this hotkey to switch from eight video preset modes (Scenery Mode, Racing Mode, Cinema Mode, RTS/RPG Mode, FPS Mode, sRGB Mode, MOBA Mode and User Mode) with GameVisual™ Video Intelligence Technology.

#### 4. GamePlus Button:

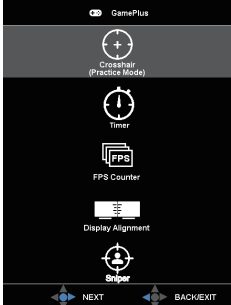
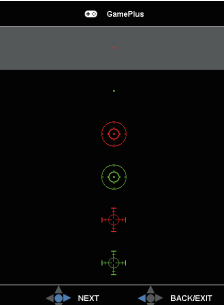
- GamePlus: The GamePlus Function provides a toolkit and creates a better gaming environment for users when playing different types of games. Particularly, Crosshair function is specially designed for new gamers or beginners interested in First Person Shooter (FPS) games.  
To active GamePlus:
  - Press GamePlus Button to enter the GamePlus main menu.

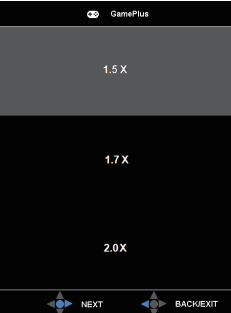
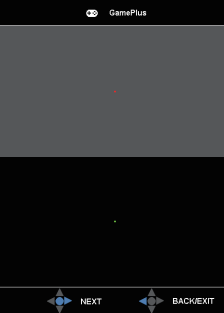
- Activate Crosshair, Timer or FPS Counter or Display Alignment function.
- Move the  () button up/down to select and press  () to confirm the function needed. Press  to go off, and exit.
- Crosshair/Timer/FPS Counter is movable by pressing  5-way key.
- To activate Sniper, you need to disable HDR on your device.

GamePlus main menu	GamePlus-Crosshair	GamePlus-Timer
		
GamePlus-Sniper		
		

5.  Close Button:
  - Exit the OSD menu.
6.  (5-way) Button:
  - Turns on the OSD menu. Enacts the selected OSD menu item.
  - Increases/Decreases values or moves your selection up/down/left/right

## 2.1 Adjusting the monitor

- For optimal viewing, we recommend that you look at the full face of the monitor, then adjust the monitor to the angle that is most comfortable for you.
- Hold the stand to prevent the monitor from falling when you change its angle.
- You can adjust the monitor's angle from  $+20^{\circ}$  to  $-5^{\circ}$  and it allows  $15^{\circ}$  swivel adjustment from either left or right. You can also adjust the monitor's height within 12cm. You can also adjust the monitor's pivot within  $90^{\circ}$ .

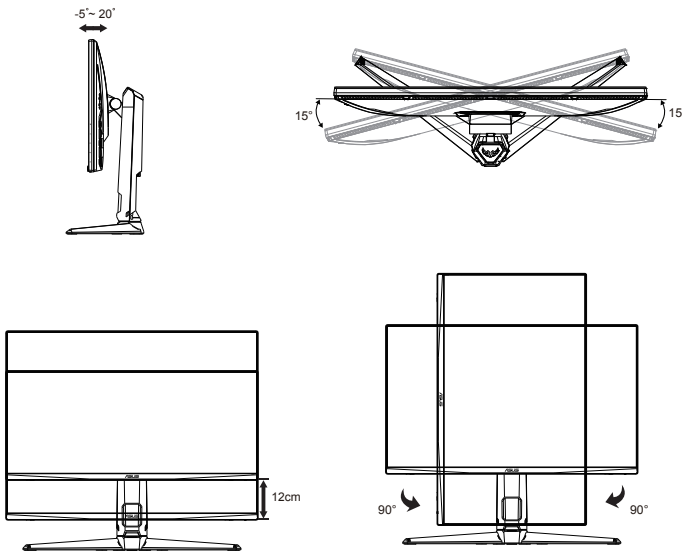

## 2.2 Detaching the arm/stand (for VESA wall mount)

The detachable stand of this monitor is specially designed for VESA wall mount.

### To detach the arm/stand

1. Disconnect power and signal cables. Carefully put the monitor facedown on its EPS packaging.
2. Remove the screws covers.
3. Remove the four (4) screws securing the arm to the rear of the monitor.
4. Detach the stand (arm and base) from the monitor.

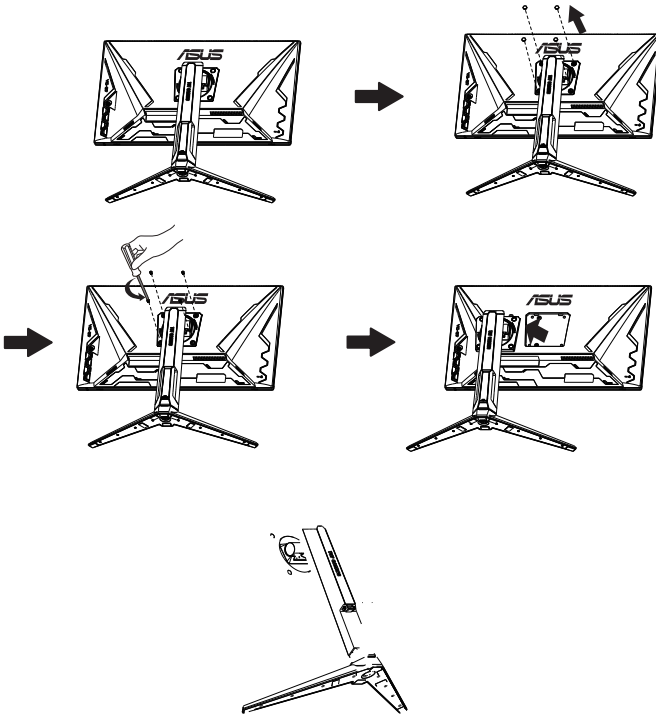

## 2.3 Outline dimension

Unit: mm

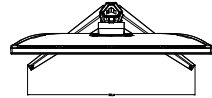
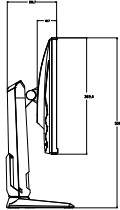
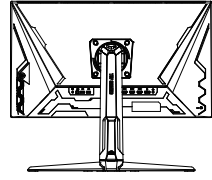
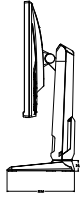
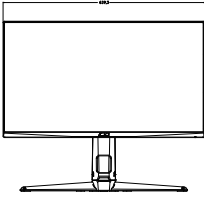

## 3.1 OSD (On-Screen Display) menu

### 3.1.1 How to reconfigure

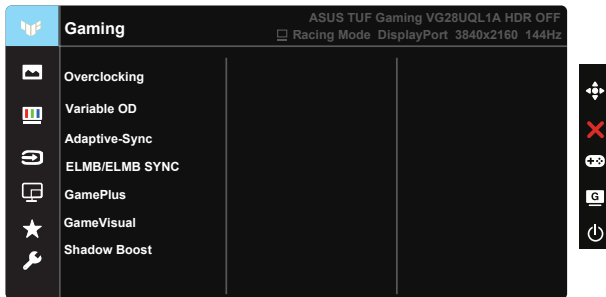

1. Press Central of 5-way to activate the OSD menu.
2. Press the ▼ and ▲ buttons to toggle between options in the Menu. As you move from one icon to another, the option name is highlighted.
3. To select the highlighted item on the menu press the Center key.
4. Press the ▼ and ▲ buttons to select the desired parameter.
5. Press the Center key to enter the slide bar and then use the ▼ or ▲ buttons, according to the indicators on the menu, to make your changes.
6. Press the ◀/▶ to move left / right menu.



## 3.1.2 OSD Function Introduction

### 1. Gaming

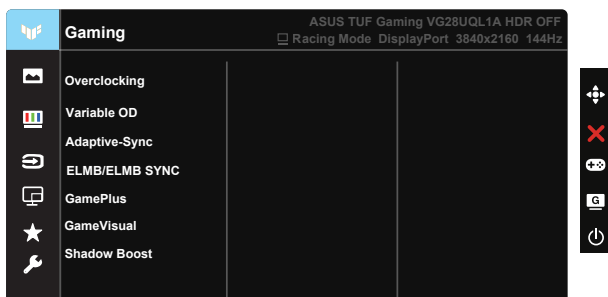

- **Overclocking:** This function allows you to adjust the refresh rate.
- **Variable OD:** Speeds up the response time by Over Drive technology. Including Level 0~Level 5.
- **Adaptive-Sync (DP)/ FreeSync Premium (HDMI):** It can allow a Adaptive-Sync (DP)/ FreeSync Premium (HDMI) supported graphics source to dynamically adjust display refresh rate based on typical content frame rates for power efficient, virtually stutter free and low-latency display update.
- **ELMB/ELMB SYNC:** Allows you to turn on the function when Adaptive-Sync (DP)/ FreeSync Premium (HDMI) is On. This function eliminates screen tearing, reduces ghosting and motion blur when playing games. When Adaptive-Sync (DP)/ FreeSync Premium (HDMI) is Off, this function can only be activated when the refresh rate is 100Hz 120Hz, 144Hz.
- **GamePlus:** Activate Crosshair, Timer, FPS Counter, Display Alignment, or Sniper
- **GameVisual:** This function contains seven sub-functions that you can select for your preference.
- **Shadow Boost:** Dark color enhancement adjust monitor gamma curve to enrich the dark tones in an image making dark scenes and objects much easier be found.



- 
- In the Racing Mode, the Saturation, and ASCR functions are not user-configurable.
  - In the sRGB Mode, the Saturation, Skin Tone, Color Temp., Brightness, Contrast and ASCR functions are not user-configurable.
  - In the MOBA Mode, the Saturation and ASCR functions are not user-configurable
-

## 2. Image

You can adjust Brightness, Contrast, HDR, VividPixel , Aspect Control and Blue Light Filter from this main function.

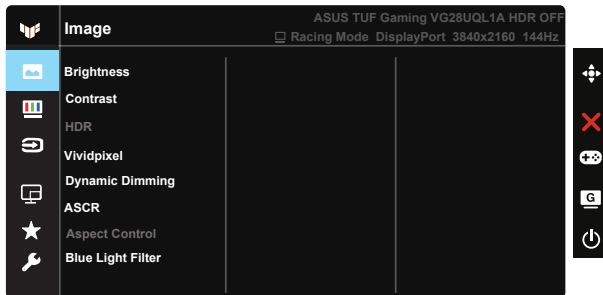

- Brightness: The adjusting range is from 0 to 100.
- Contrast: The adjusting range is from 0 to 100.
- HDR: High Dynamic Range. Contains three HDR modes (ASUS Cinema HDR, ASUS Gaming HDR and Console Mode).
- Dynamic Dimming: Dynamic local dimming, turn on this feature to improve the dynamic contrast.
- VividPixel: ASUS Exclusive Technology that brings lifelike visuals for crystal-clear and detail-oriented enjoyment. The adjusting range is from 0 to 100.
- ASCR: Select ON or OFF to enable or disable dynamic contrast ratio function.
- Aspect Control: Adjusts the aspect ratio to "Full" and 4:3, 16:9 (24"W) .
- Blue Light Filter: Adjust the energy level of blue light emitted from LED backlight.



- 
- When Blue Light Filter is activated, the default settings of Standard Mode will be automatically imported.
  - Between Level 1 to Level 3, the Brightness function is user-configurable.
  - Level 4 is optimized setting. The Brightness function is not user-configurable
  - The Monitor use low blue light panel and compliance with TÜV Rheinland at factory reset/default setting mode.
- 



- 4:3 is only available when input source is in 4:3 format.
- 



Please refer to the following to alleviate eye strains:

- Users should take some time away from the display if working for long hours. It is advised to take short breaks (at least 5 mins) after around 1 hour of continuous working at the computer. Taking short and frequent breaks is more effective than a single longer break.
  - To minimize eye strain and dryness in your eyes, users should rest the eye periodically by focusing on objects that are far away.
  - Eye exercises can help to reduce eye strain. Repeat these exercises often. If eye strain continues please consult a physician. Eye exercises: (1) Repeating look up and down (2) Slowly roll your eyes (3) Move your eyes diagonal.
  - High energy blue light may lead to eye strain and AMD (Age-Related Macular Degeneration). Blue light Filter to reduce 70% (max.) harmful blue light to avoiding CVS (Computer Vision Syndrome).
-

### 3. Color

Select the image color you like from this function.

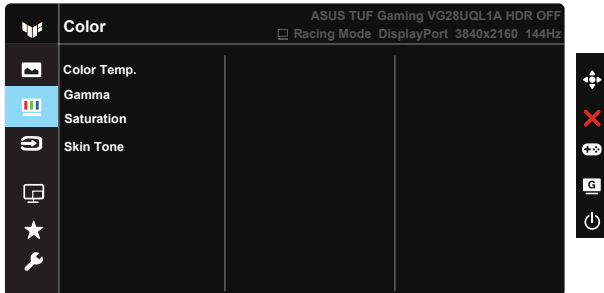

- Color Temp.: Contains three preset color modes (Cool, Normal, Warm) and User Mode.
- Gamma: Contains five gamma modes including 1.8, 2.2, 2.5.
- Saturation: The adjusting range is from 0 to 100.
- Skin Tone: Contains three color modes including Reddish, Natural, and Yellowish



- 
- In the User Mode, colors of R (Red), G (Green), and B (Blue) are user-configurable; the adjusting range is from 0 ~ 100.
-

#### 4. Input Select

Select your desired input source and toggle the Auto Input Detection function between on and off. The monitor input source will not automatically switch when the Auto Input Detection function is disabled.

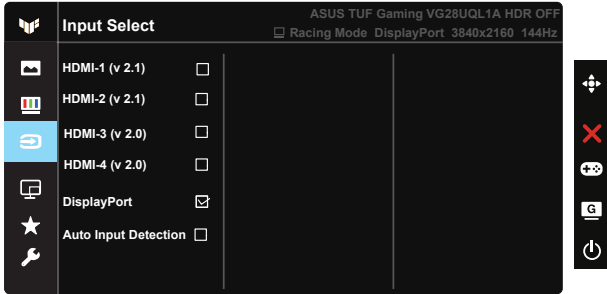

#### 5. PIP/PBP Setup

The PIP/PBP Setup allows you to open up sub-window(s) connected from any video source.

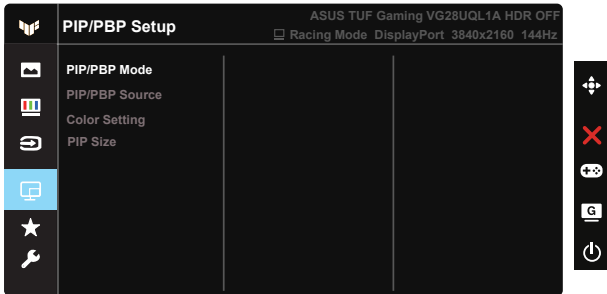

- PIP/PBP Mode: Select PIP, PBP or turn it off.
- PIP/PBP Source: Selects the video input source among, HDMI-1 (v 2.1), HDMI-2 (v 2.1), , HDMI-3 (v 2.0), HDMI-4 (v 2.0) or DisplayPort.
- Color Setting: Adjust the Color Setting.
- PIP Size: Adjust the PIP size to “Small”, “Middle”, or “Large”.

#### 6. MyFavorite

You can adjust Shortcut and Customized Setting from this main function.

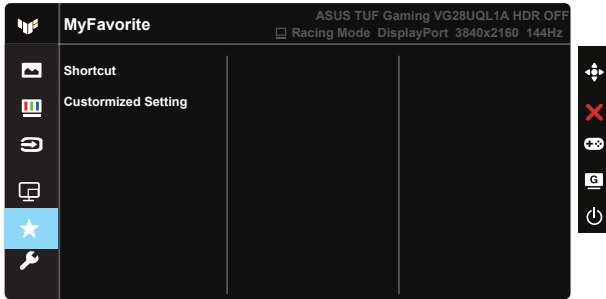

- **Shortcut :** User can select from “GamePlus”, “GameVisual”, “Brightness”, “Contrast”, “PIP/PBP Setup”, “Input Select”, “HDR”, “Blue Light Filter”, “Color Temp.,” “Volume”, “MyFavorite-1 (Load)”, “MyFavorite-2 (Load)” and set as shortcut key.
- **Customized Setting :** You can do your setting according to your favorite.

## 7. System Setup

Adjusts the system configuration.

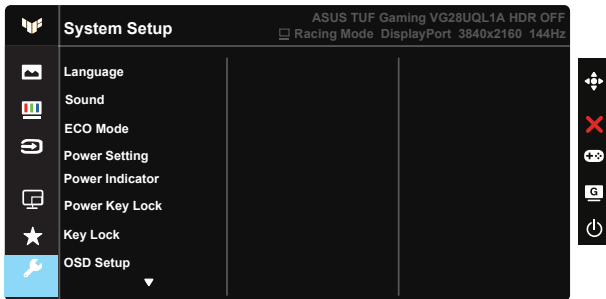

- **Language:** Select OSD language. The selections are: English, French, German, Spanish, Italian, Dutch, Russian, Poland, Czech, Croatia, Hungary, Romania, Portugal, Turkey, Simplified Chinese, Traditional Chinese, Japanese, Korean, Persian, Thai, Indonesian, Ukrainian.

- Sound: Adjusts the output volume level or mute the audio.
- ECO Mode: Activate the ecology mode for power saving.
- Power Setting: Standard Mode or Power Saving Mode.
- Power Indicator: Turn the power LED indicator on/off.
- Power Key Lock: To disable / enable power key.
- Key Lock: Disable all key functions. Pressing the down button for more than five seconds to disable key lock function.
- OSD Setup: Adjusts the OSD Timeout, DDC/CI, and Transparency of the OSD screen.
- DisplayPort Stream: Switch DP Version to 1.2 or 1.4.
- DSC: Turn the DSC on/off.
- HDMI CEC: Turn the HDMI CEC on/off.
- Information: Displays the monitor information.
- All Reset: Selects “Yes” to revert all settings to the factory default mode

## 3.2 Specifications

<b>Model</b>	VG28UQL1A
Panel Size	28"W
Max. Resolution	3840x2160@144Hz
Brightness (Typ.)	300cd/m <sup>2</sup>
Intrinsic Contrast Ratio (Typ.)	1000:1
Viewing Angle (CR=10)	178 (V) /178 (H)
Display Colors	1073.7M(10 bit)
Color Saturation	DCI-P3 90% (min)
Response Time	1ms (G To G )
Satellite Speaker	2W x 2 stereo
Earphone Output	Yes
Sound from HDMI	Yes
HDMI input	Yes
DisplayPort input	Yes
Power ON Consumption(Max.)	< 70 W*
Chassis Colors	Black
Power saving mode	< 0.5W
Power off mode	< 0.5W
Tilt	-5 ~ +20
Phys. Dimension (WxHxD)	639.5x539.8x213.8 mm
Box Dimension (WxHxD)	716 x 446 x 224 mm
Net Weight (Esti.)	6.89 kg
Gross Weight (Esti.)	10.4 kg
Voltage Rating	Adapter 20Vdc, 6A



### 3.3 Troubleshooting (FAQ)

Problem	Possible Solution
Power LED is not ON	<ul style="list-style-type: none"> <li>• Press the  button to check if the monitor is in the ON mode.</li> <li>• Check if the power cord is properly connected to the monitor and the power outlet.</li> <li>• Check Power Indicator function in main menu OSD. Select "ON" to turn on power LED.</li> </ul>
The power LED lights amber and there is no screen image	<ul style="list-style-type: none"> <li>• Check if the monitor and the computer are in the ON mode.</li> <li>• Make sure the signal cable is properly connected the monitor and the computer.</li> <li>• Inspect the signal cable and make sure none of the pins are bent.</li> <li>• Connect the computer with another available monitor to check if the computer is properly working.</li> </ul>
Screen image is too light or dark	<ul style="list-style-type: none"> <li>• Adjust the Contrast and Brightness settings via OSD.</li> </ul>
Screen image bounces or a wave pattern is present in the image	<ul style="list-style-type: none"> <li>• Make sure the signal cable is properly connected to the monitor and the computer.</li> <li>• Move electrical devices that may cause electrical interference.</li> </ul>
Screen image has color defects (white does not look white)	<ul style="list-style-type: none"> <li>• Inspect the signal cable and make sure that none of the pins are bent.</li> <li>• Perform Reset via OSD.</li> <li>• Adjust the R/G/B color settings or select the Color Temperature via OSD.</li> </ul>
No sound or sound is low	<ul style="list-style-type: none"> <li>• Adjust the volume settings of both your monitor and computer.</li> <li>• Make sure the computer sound card driver is properly installed and activated.</li> </ul>

### 3.4 Supported Timing List

#### HDMI2.0

	Support Timing table (PC timing)		Support Timing table (Video timing)
1	640x480 60Hz	1	720x480P 60Hz
2	640x480 67Hz	2	720x576P 50Hz
3	640x480 72Hz	3	1440x480P 60Hz
4	640x480 75Hz	4	1440x576P 50Hz
5	720x400 70Hz	5	1280x720P 50Hz
6	800x600 56Hz	6	1280x720P 60Hz
7	800x600 60Hz	7	1920x1080 P 50Hz
8	800x600 72Hz	8	1920x1080P 60Hz
9	800x600 75Hz	9	1920x1080P 120Hz
10	1024x768 60Hz	10	3840x2160P 24Hz
11	1024x768 70Hz	11	3840x2160P 25Hz
12	1024x768 75Hz	12	3840x2160P 30Hz
13	1152x864 75Hz	13	3840x2160P 50Hz
14	1280x720 60Hz	14	3840x2160P 60Hz
15	1280x960 60Hz		
16	1280x1024 60Hz		
17	1280x1024 75Hz		
18	1440x900 60Hz		
19	1680x1050 60Hz		
20	1920x1080 60Hz		
21	1920x2160 60Hz		
22	2560x1440 120Hz		
23	2560x1440 144Hz		
24	3840x2160 60Hz		

## HDMI2.1

	Support Timing table (PC timing)		Support Timing table (Video timing)
1	640x480 60Hz	1	640x480P 60Hz
2	640x480 67Hz	2	720x480P 60Hz
3	640x480 72Hz	3	720x576P 50Hz
4	640x480 75Hz	4	1440x480P 60Hz
5	720x400 70Hz	5	1440x576P 50Hz
6	800x600 56Hz	6	1280x720P 50Hz
7	800x600 60Hz	7	1280x720P 60Hz
8	800x600 72Hz	8	1920x1080 P 50Hz
9	800x600 75Hz	9	1920x1080P 60Hz
10	1024x768 60Hz	10	3840x2160P 24Hz
11	1024x768 70Hz	11	3840x2160P 25Hz
12	1024x768 75Hz	12	3840x2160P 30Hz
13	1152x864 75Hz	13	3840x2160P 50Hz
14	1280x720 60Hz	14	3840x2160P 60Hz
15	1280x960 60Hz	15	3840x2160P 120Hz
16	1280x1024 60Hz		
17	1280x1024 75Hz		
18	1440x900 60Hz		
19	1680x1050 60Hz		
20	1920x1080 60Hz		
21	1920x2160 60Hz		
22	2560x1440 119.8Hz		
23	2560x1440 144Hz		
24	3840x1600 144Hz		
25	3840x2160 60Hz		
26	3840x2160 100Hz		
27	3840x2160 144Hz		

## DP1.4(HDR400)

Support Timing table		Support Timing table	
1	640x480 60Hz	1	1440x480P 60Hz
2	640x480 67Hz	2	1440x576P 50Hz
3	640x480 72Hz	3	1280x720P 50Hz
4	640x480 75Hz	4	1280x720P 60Hz
5	720x400 70Hz	5	1280x720P 120Hz
6	800x600 56Hz	6	1920x1080 P 50Hz
7	800x600 60Hz	7	1920x1080P 60Hz
8	800x600 72Hz	8	1920x1080P 120Hz
9	800x600 75Hz	9	3840x2160P 24Hz
10	1024x768 60Hz	10	3840x2160P 25Hz
11	1024x768 70Hz	11	3840x2160P 30Hz
12	1024x768 75Hz	12	3840x2160P 50Hz
13	1152x864 75Hz	13	3840x2160P 60Hz
14	1280x720 60Hz		
15	1280x960 60Hz		
16	1280x1024 60Hz		
17	1280x1024 75Hz		
18	1440x900 60Hz		
19	1680x1050 60Hz		
20	1920x1080 60Hz		
21	1920x2160 60Hz		
22	2560x1440 120Hz		
23	2560x1440 144Hz		
24	3840x2160 60Hz		
25	3840x1600 144Hz		
26	3840x2160 100Hz		
27	3840x2160 120Hz		
28	3840x2160 144Hz		

\* The modes not listed in the above tables may not be supported. For optimal resolution, we recommend that you choose a mode listed in the above tables.

