

EB-PU2113W/EB-PU2213B/EB-PU2116W/EB-PU2216B/
EB-PU2120W/EB-PU2220B

Quick Reference

This *Quick Reference* card gives brief instructions on connecting your projector and using common features. For details, see the online *User's Guide*.

IMPORTANT: Before using this product, make sure you read these instructions and the safety instructions in the online *User's Guide*.

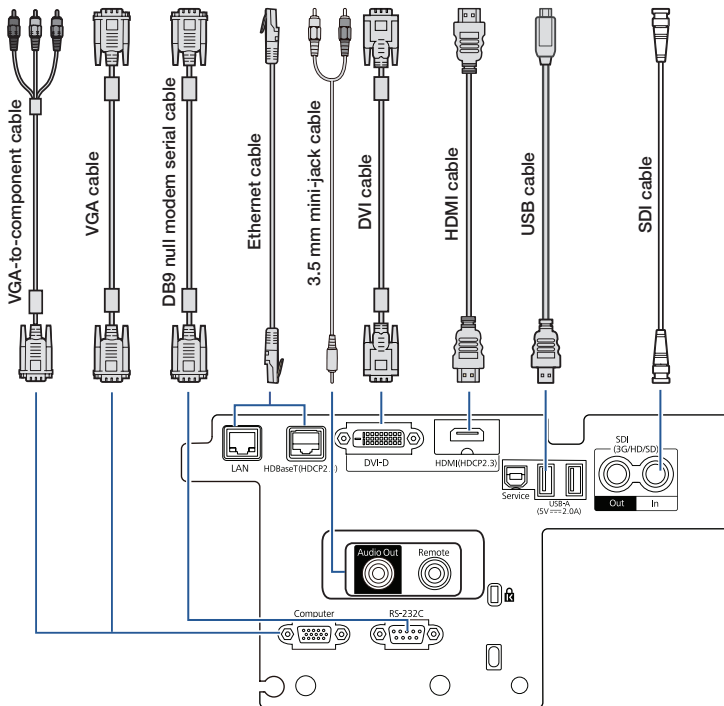

Note: The SDI ports are only available on the EB-PU2213B, EB-PU2216B, and EB-PU2220B.

Note: Availability of products varies by country.

Turning the Projector On

1. Turn on your computer or image source.
2. Remove the lens cover.
3. Press the **ⓘ On** button on the projector or the remote control. After the status light stays blue, the projector is ready.

Note: If the Direct Power On function is enabled, you can turn the projector on without pressing the **ⓘ On** button; just plug it in or flip the switch controlling the outlet to which the projector is connected. To turn on this feature, see the online *User's Guide*.

If your image does not appear, see “Switching Between Image Sources” or “Troubleshooting.”

Note: This projector requires a 220 V power source for normal operation. Limited functionality is temporarily available when connected to a 120 V power source. For details, see your online *User Guide*.

Changing the Language of the Projector Menu

The default language of the projector's menu system is English, but you can change it as necessary.

1. Press the **Menu** button to access the projector's menu system.
2. Select **Extended > Language**.
3. Select your language.
4. When you're done, press the **Menu** button to exit.

Switching Between Image Sources

Press the **Search** button or one of the source buttons (remote control), or the **Source Search** button (projector).

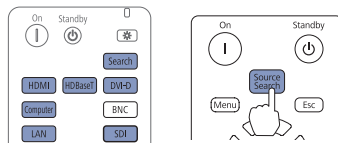

Selecting the Lens Type

Make sure the Lens Type setting is correct for the lens you are using.

1. Press the **Menu** button.
2. Select **Extended > Operation > Advanced > Lens Type**.

Note: If the Lens Type setting is greyed out, the projector has automatically detected the installed lens and you can skip the remaining steps.

3. Select the lens you are using.
4. When you're done, press the **Menu** button to exit.

Changing Screen Type

Set the Screen Type setting to the screen's aspect ratio.

1. Press the **Menu** button.
2. Select **Extended > Display > Screen > Screen Type**.
3. Select the screen's aspect ratio.

Note: The displayed image should match the screen's size and aspect ratio.

- When you're done, press the **Menu** button to exit.

Note: After changing the screen type, you may need to change the aspect ratio of the projected image depending on the input signal. Press the **Aspect** button on the remote control to change the aspect ratio, if necessary.

Adjusting Image Position

- Press the **Lens Shift** button (remote control) or the **Lens** button (projector).

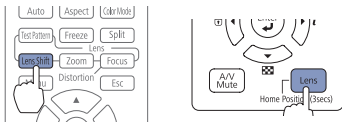

- Press the arrow buttons to adjust the position of the projected image.
- When you're done, press the **Esc** button to finish the adjustment.

If the projector is on a table, you can level the image by turning any of the projector's adjustable feet.

Zooming and Focusing

- On the remote control, press the **Zoom** or **Focus** button.

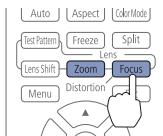

On the projector, press the **Lens** button repeatedly until the focus or zoom adjustment screen is shown.

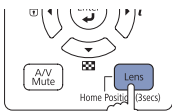

- Press the ◀ or ▶ arrow buttons to make the adjustment.
- Press the **Esc** button to finish the adjustment.

Correcting Image Shape

If your image is uneven on the sides, you can use the projector's distortion correction features, such as H/V-Keystone and Quick Corner®, to adjust the shape. See the online *User's Guide*.

Making Other Image Adjustments

For help on using the projector's features to improve the image quality, see the online *User's Guide*. You can also view information on how to adjust the image color, position, and edges (Edge Blending) when projecting from multiple projectors to create one seamless widescreen image.

Turning the Projector Off

Press the ⏻ **Standby** button to turn the projector off. If you see a confirmation message, press the ⏻ **Standby** button again.

Note: If the Direct Power On function is enabled, you can unplug the projector or flip the switch controlling the outlet to which the projector is connected instead. To turn on this feature, see the online *User's Guide*.

With Epson's Instant Off® technology, you don't have to wait for the projector to cool down; just turn it off or unplug it when you're done.

Troubleshooting

If you see a blank screen or the message *No signal*

- Make sure the status light on the projector is blue and not flashing, and the lens cover is removed.
- Make sure the cables are connected correctly. See the online *User's Guide*.
- You may need to change the image source. See "Switching Between Image Sources." Also make sure the source device is turned on.

If the projector and the notebook don't display the same image

Windows®

If you are using a Windows laptop, press the function key on your keyboard that lets you display on an external monitor. It may be labeled **CRT/LCD** or have an icon such as . You may have to hold down the **Fn** key while pressing it (such as **Fn + F7**). Wait a moment for the display to appear.

On Windows 7 or later, hold down the Windows key and press **P** at the same time, then click **Duplicate**.

Mac

On macOS 12, select **System Preferences > Displays > Display Settings**. Select the projector, then choose the mirror option for your display from the drop-down menu.

On macOS 11 and older, open **System Preferences** and select **Displays**. Click the **Arrangement** tab and select the **Mirror Displays** checkbox.

Where to Get Help

Manuals

For more information about using the projector, you can view or download the online manuals from the Epson website, as described below.

Internet support

Visit <http://epson.com/support> (U.S.) or <http://epson.ca/support> (Canada) and search for your product to download software and utilities, view manuals, get FAQs and troubleshooting advice, or contact Epson.

Speak to a support representative

To use the Epson® PrivateLine® Support service, call (800) 637-7661. This service is available for the duration of your warranty period. You may also speak with a projector support specialist by dialing (562) 276-4394 (U.S.) or (905) 709-3839 (Canada).

Support hours are 7 AM to 4 PM, Pacific Time, Monday through Friday.

Days and hours of support are subject to change without notice. Toll or long distance charges may apply.

Purchase supplies and accessories

You can purchase screens or other accessories from an Epson authorized reseller. To find the nearest reseller, call 800-GO-EPSON (800-463-7766). Or you can purchase online at <http://epsonstore.com> (U.S. sales) or <http://epsonstore.ca> (Canadian sales).

For a list of optional accessories, see the online *User's Guide*.

Remote Control Map

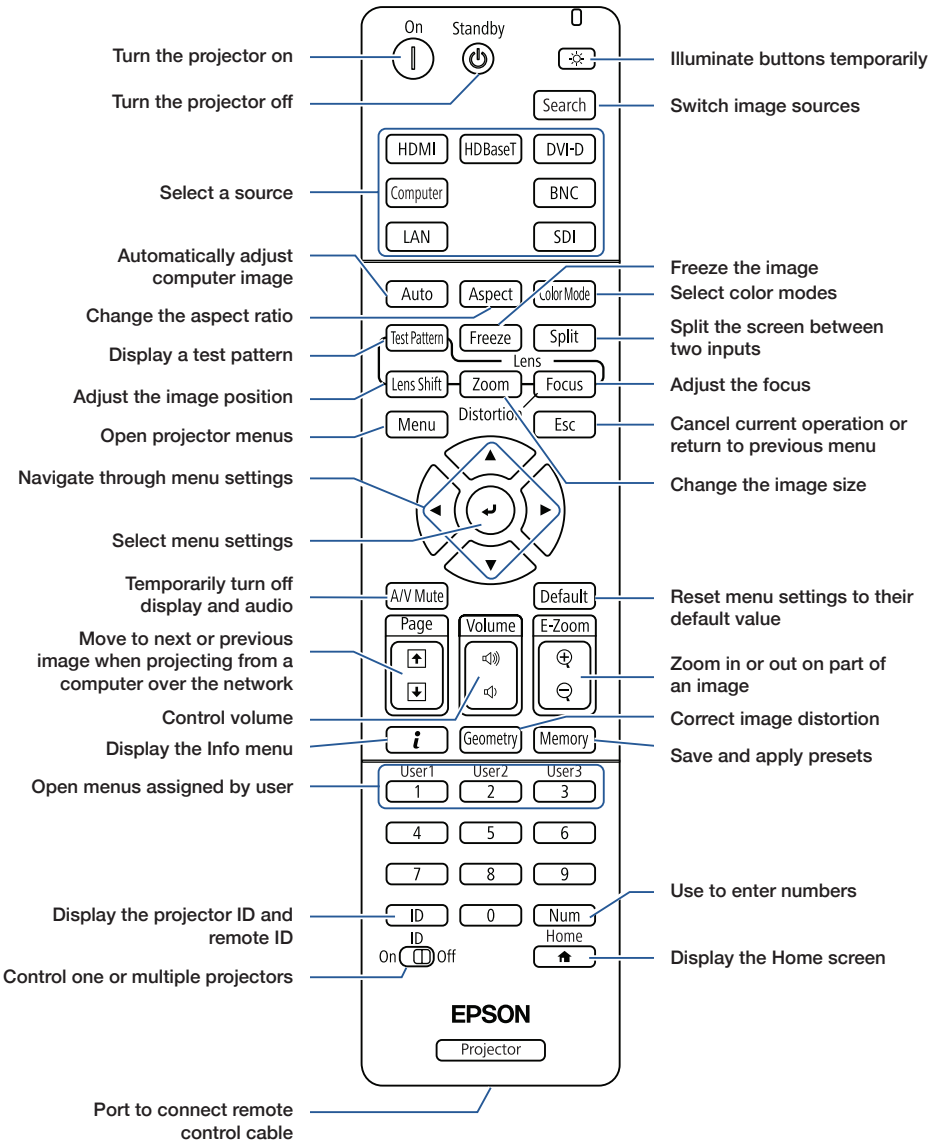

EPSON[®]
EXCEED YOUR VISION



EPSON, Instant Off, and Quick Corner are registered trademarks and EPSON Exceed Your Vision is a registered logomark of Seiko Epson Corporation.

PrivateLine is a registered trademark of Epson America, Inc.

Windows is a registered trademark of Microsoft Corporation in the United States and/or other countries.

Mac and macOS are trademarks of Apple Inc., registered in the U.S. and other countries.

HDBaseT is a trademark of the HDBaseT Alliance.

General Notice: Other product names used herein are for identification purposes only and may be trademarks of their respective owners. Epson disclaims any and all rights in those marks.

This information is subject to change without notice.

© 2022 Epson America, Inc., 1/22

CPD-61928



414251200