

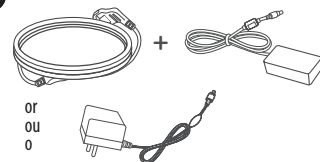

**26WQ500/26BQ500**

**29WQ500/29WQ50T**

**34WQ500**

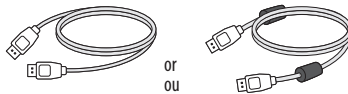

**26WQ500/26BQ500**

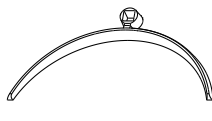
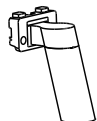

M4 X L10

**29WQ500/29WQ50T**



M4 X L10

**34WQ500**

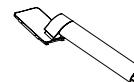

**+** English Depending on country / Français Selon les pays / Español En función del país



(2208-REV03)





### **English**

- For EPEAT (EPEAT applied model)

Spare parts are available for 5 years after the end of production.

Spare parts include base assembly, adapter and cables.

It may differ by model, you can get the more information by visiting to this website:

*<https://lgparts.com/>*

### **Français**

- Pour EPEAT (modèles pour lesquels s'applique EPEAT)

Les pièces de rechange sont disponibles jusqu'à cinq ans après la fin de la production.

Elles comprennent les pièces pour l'assemblage de la base, l'adaptateur et les câbles.

Les pièces de rechange peuvent varier selon le modèle. Vous pouvez obtenir plus de renseignements en visitant le site Web

*<https://lgparts.com/>*



**English**

**Quick Setup Guide**

Please read this manual carefully before operating your set and retain it for future reference.

**Français**

**Guide de configuration rapide**

Veuillez lire ce guide de configuration rapide attentivement avant d'utiliser votre produit et conservez-le pour pouvoir vous y reporter ultérieurement.

**Español**

**Guía Rápida de Configuración**

Lea atentamente este manual antes de poner en funcionamiento el equipo y consérvelo para futuras consultas.



**English**

It is recommended that use the supplied components.

**Français**

Il est recommandé d'utiliser les composants fournis.

**Español**

Se recomienda utilizar los componentes suministrados.



[www.lg.com](http://www.lg.com)

**English**

You can download manuals from the LGE website.

**Français**

Vous pouvez télécharger les guides pour ce produit à partir du site Web de LGE.

**Español**

Puede descargar los manuales del sitio web de LGE.



26WQ500

26BQ500

1

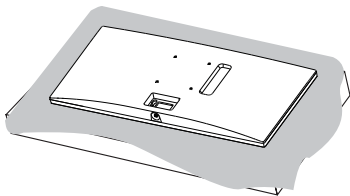

2

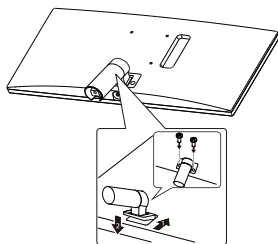

3

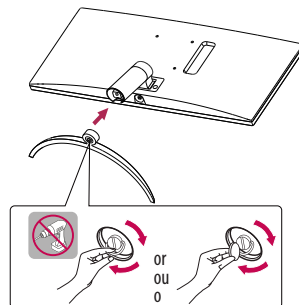

4

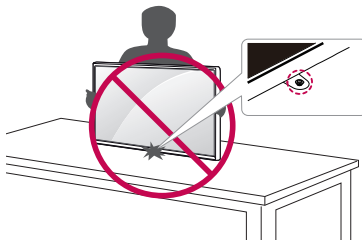
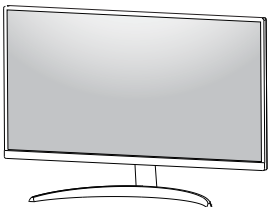



29WQ500

29WQ50T

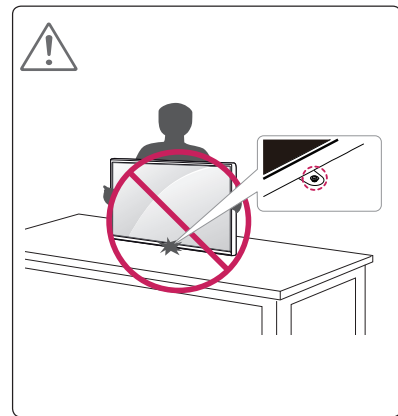
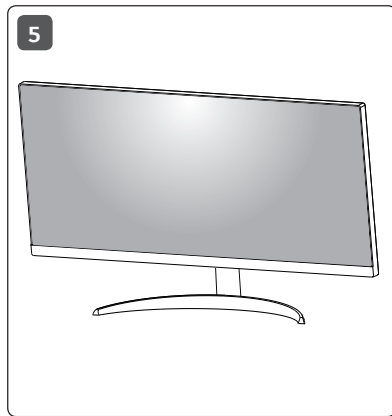
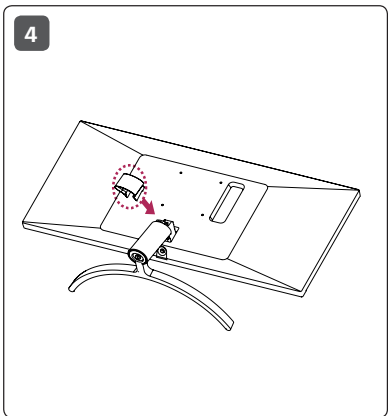
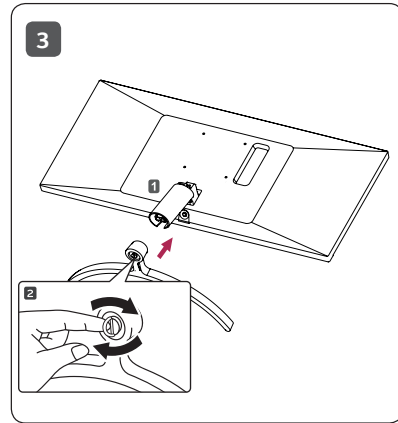
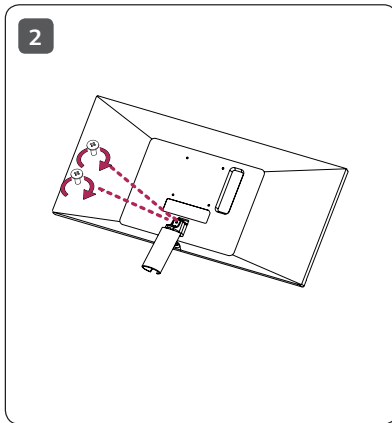
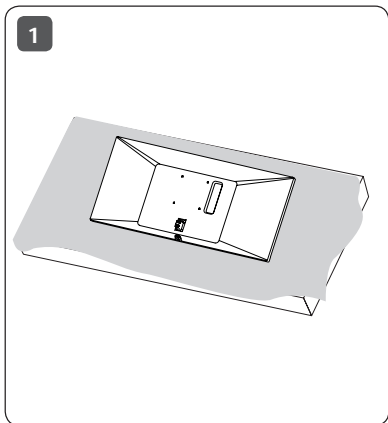





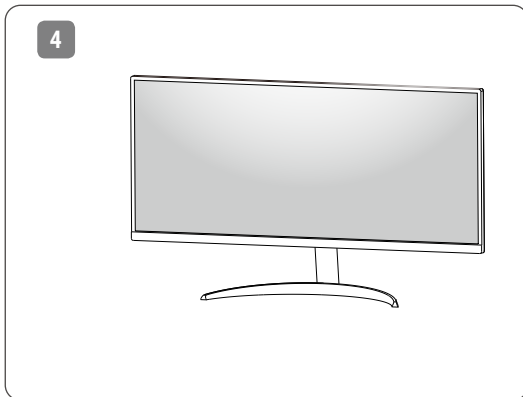
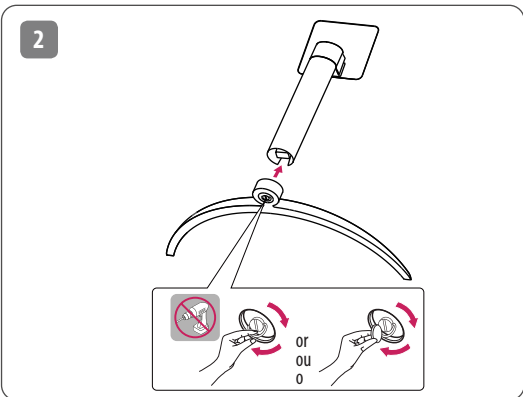
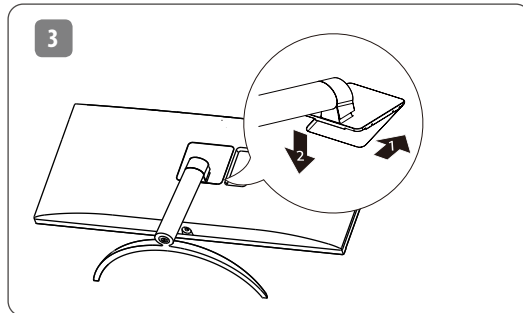
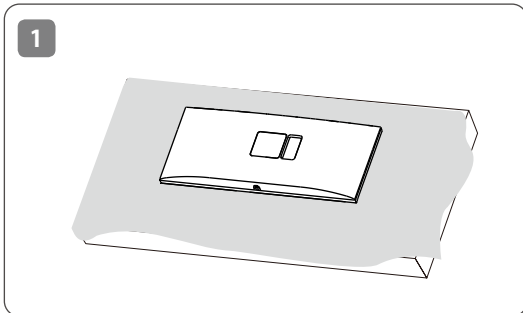
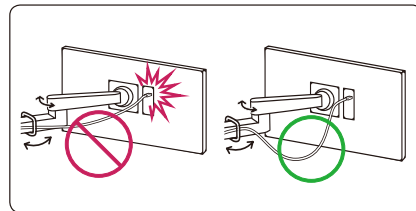
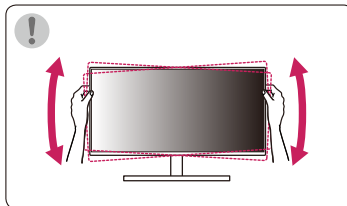
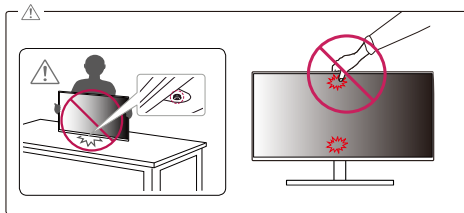

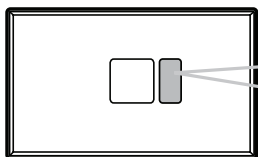

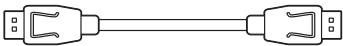
34WQ500





|  | 26WQ500<br>26BQ500 | 29WQ500<br>29WQ50T<br>34WQ500 |
|--|--------------------|-------------------------------|
|  DP IN   DP OUT<br>PC        |                    | ●                             |
|  HDMI IN   HDMI OUT<br>AV/PC | ●                  | ●                             |
|  H/P   |                    |                               |



### English

- Using a DVI to HDMI / DP (DisplayPort) to HDMI cable may cause compatibility issues.
- Make sure to use the supplied cable. Otherwise, this may cause the device to malfunction.

### Français

- L'utilisation d'un câble DVI à HDMI ou DP (DisplayPort) à HDMI peut présenter des problèmes de compatibilité.
- Assurez-vous d'utiliser le câble fourni avec le produit. Le non-respect de cette consigne peut entraîner un dysfonctionnement du périphérique.

### Español

- El uso de un cable de DVI a HDMI / DP (DisplayPort) a HDMI puede causar problemas de compatibilidad.
- Asegúrese de utilizar el cable suministrado con el producto. De lo contrario, puede provocar que el dispositivo no funcione correctamente.



26WQ500

26BQ500

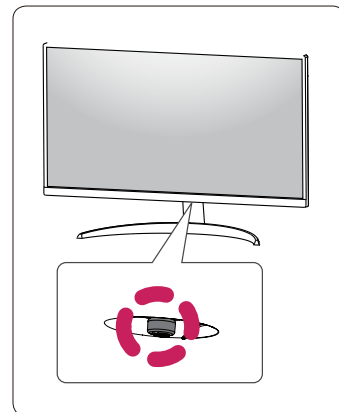
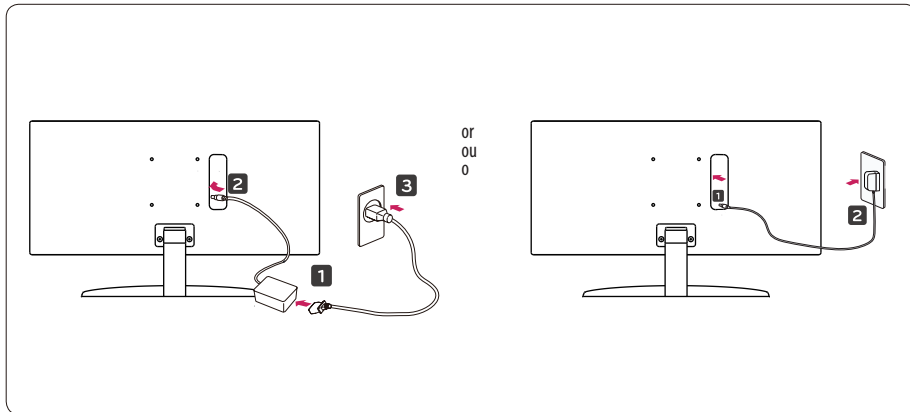

29WQ500

29WQ50T

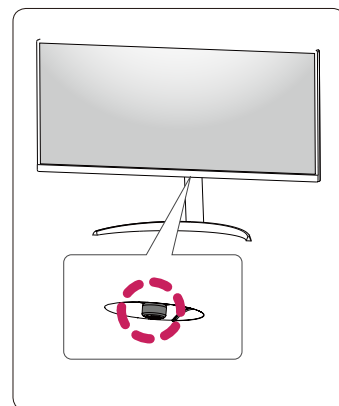
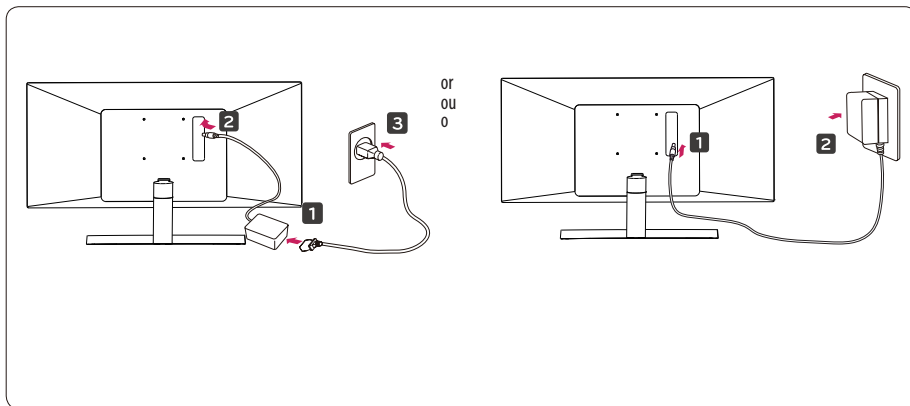





34WQ500

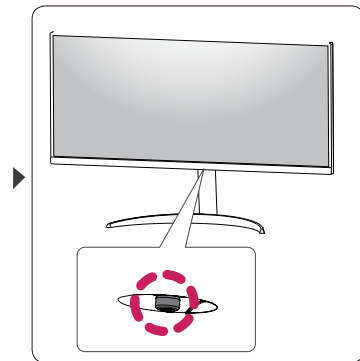
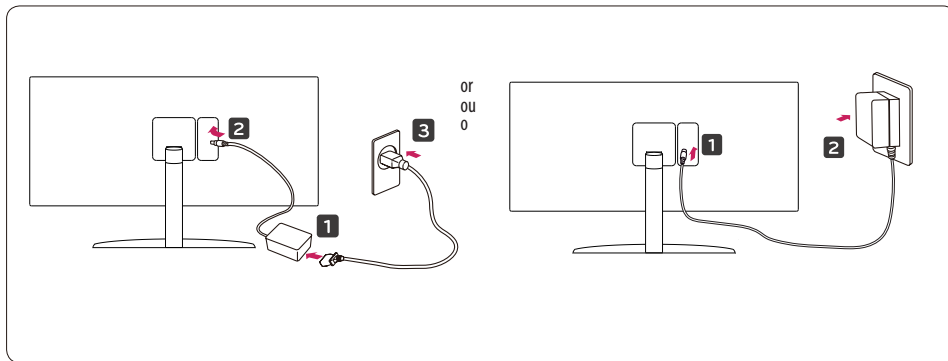



|          | Dimensions (Width x Height x Depth)           |   | Weight                                    |   | Recommend Resolution             | Vertical Frequency  |       |
|----------|---|---|---|---|----------------------------------|---------------------|-------|
|          | With Stand                                    | Without Stand                                 | With Stand                                | Without Stand                             |                                  |                     |       |
| English  | 26WQ500                                       | 635.7 x 385.3 x 211.5 (mm)                    | 635.7 x 292.8 x 46.0 (mm)                 | 3.6 kg                                    | 3.1 kg                           | 2560 x 1080         | 60 Hz |
|          | 26BQ500                                       | 25.0 x 15.1 x 8.3 (inches)                    | 25.0 x 11.5 x 1.8 (inches)                | 7.9(lbs)                                  | 6.8(lbs)                         |                     |       |
|          | 29WQ500                                       | 688.5 x 406.8 x 223.8 (mm)                    | 688.5 x 313.4 x 45.3 (mm)                 | 4.5 kg                                    | 4.0 kg                           |                     |       |
|          | 29WQ50T                                       | 27.1 x 16.0 x 8.8 (inches)                    | 27.1 x 12.3 x 1.7 (inches)                | 9.9(lbs)                                  | 8.8(lbs)                         |                     |       |
|          | 34WQ500                                       | 816.5 x 483.7 x 223.3 (mm)                    | 816.5 x 365.3 x 45.5 (mm)                 | 6.9 kg                                    | 6.0 kg                           |                     |       |
|          |   | 32.1 x 19.0 x 8.7 (inches)                    | 32.1 x 14.3 x 1.7 (inches)                | 15.2(lbs)                                 | 13.2(lbs)                        |                     |       |
|          | Dimensions (largeur x hauteur x profondeur)   |   | Poids                                     |   | Résolution recommandée           | Fréquence verticale |       |
|          | Avec socle                                    | Sans socle                                    | Avec socle                                | Sans socle                                |                                  |                     |       |
| Français | 26WQ500                                       | 635,7 x 385,3 x 211,5 (mm)                    | 635,7 x 292,8 x 46,0 (mm)                 | 3,6 kg                                    | 3,1 kg                           | 2560 x 1080         | 60 Hz |
|          | 26BQ500                                       | 25,0 x 15,1 x 8,3 (po)                        | 25,0 x 11,5 x 1,8 (po)                    | 7,9 (lb)                                  | 6,8 (lb)                         |                     |       |
|          | 29WQ500                                       | 688,5 x 406,8 x 223,8 (mm)                    | 688,5 x 313,4 x 45,3 (mm)                 | 4,5 kg                                    | 4,0 kg                           |                     |       |
|          | 29WQ50T                                       | 27,1 x 16,0 x 8,8 (po)                        | 27,1 x 12,3 x 1,7 (po)                    | 9,9 (lb)                                  | 8,8 (lb)                         |                     |       |
|          | 34WQ500                                       | 816,5 x 483,7 x 223,3 (mm)                    | 816,5 x 365,3 x 45,5 (mm)                 | 6,9 kg                                    | 6,0 kg                           |                     |       |
|          |   | 32,1 x 19,0 x 8,7 (po)                        | 32,1 x 14,3 x 1,7 (po)                    | 15,2 (lb)                                 | 13,2 (lb)                        |                     |       |
|          | Dimensiones (anchura x altura x profundidad)  |   | Peso                                      |   | Resolución recomendada (Píxeles) | Frecuencia vertical |       |
|          | Soporte incluido                              | Soporte no incluido                           | Soporte incluido                          | Soporte no incluido                       |                                  |                     |       |
| Español  | 26WQ500                                       | 635,7 x 385,3 x 211,5 (mm)                    | 635,7 x 292,8 x 46,0 (mm)                 | 3,6 kg                                    | 3,1 kg                           | 2 560 x 1 080       | 60 Hz |
|          | 26BQ500                                       |   |   |   |                                  |                     |       |
|          | 29WQ500                                       | 688,5 x 406,8 x 223,8 (mm)                    | 688,5 x 313,4 x 45,3 (mm)                 | 4,5 kg                                    | 4,0 kg                           |                     |       |
|          | 29WQ50T                                       |   |   |   |                                  |                     |       |
|          | 34WQ500                                       | 816,5 x 483,7 x 223,3 (mm)                    | 816,5 x 365,3 x 45,5 (mm)                 | 6,9 kg                                    | 6,0 kg                           |                     |       |
|          | 26WQ500                                       | <b>Clasificación de potencia</b>              |   | 19V --- 1,3 A                             |                                  |                     |       |
|          | 26BQ500                                       |   |   |   |                                  |                     |       |
|          | 29WQ500                                       | <b>Especificaciones de Adaptador de ca/cc</b> | Salida                                    | 19V --- 1,3 A                             |                                  |                     |       |
|          | 29WQ50T                                       |   | Entrada                                   | 100-240 V~ 50/60 Hz 0,7 A o 1,0 A o 1,1 A |                                  |                     |       |
|          | 34WQ500                                       | <b>Clasificación de potencia</b>              |   | 19V --- 1,6 A                             |                                  |                     |       |
|          | <b>Especificaciones de Adaptador de ca/cc</b> | Salida  | 19V --- 1,7 A                             |   |                                  |                     |       |
|          |   | Entrada                                       | 100-240 V~ 50/60 Hz 1,0 A o 1,1 A o 1,2 A |   |                                  |                     |       |



