

**NEC**

Desktop Monitor

# MultiSync E242N

User's Manual

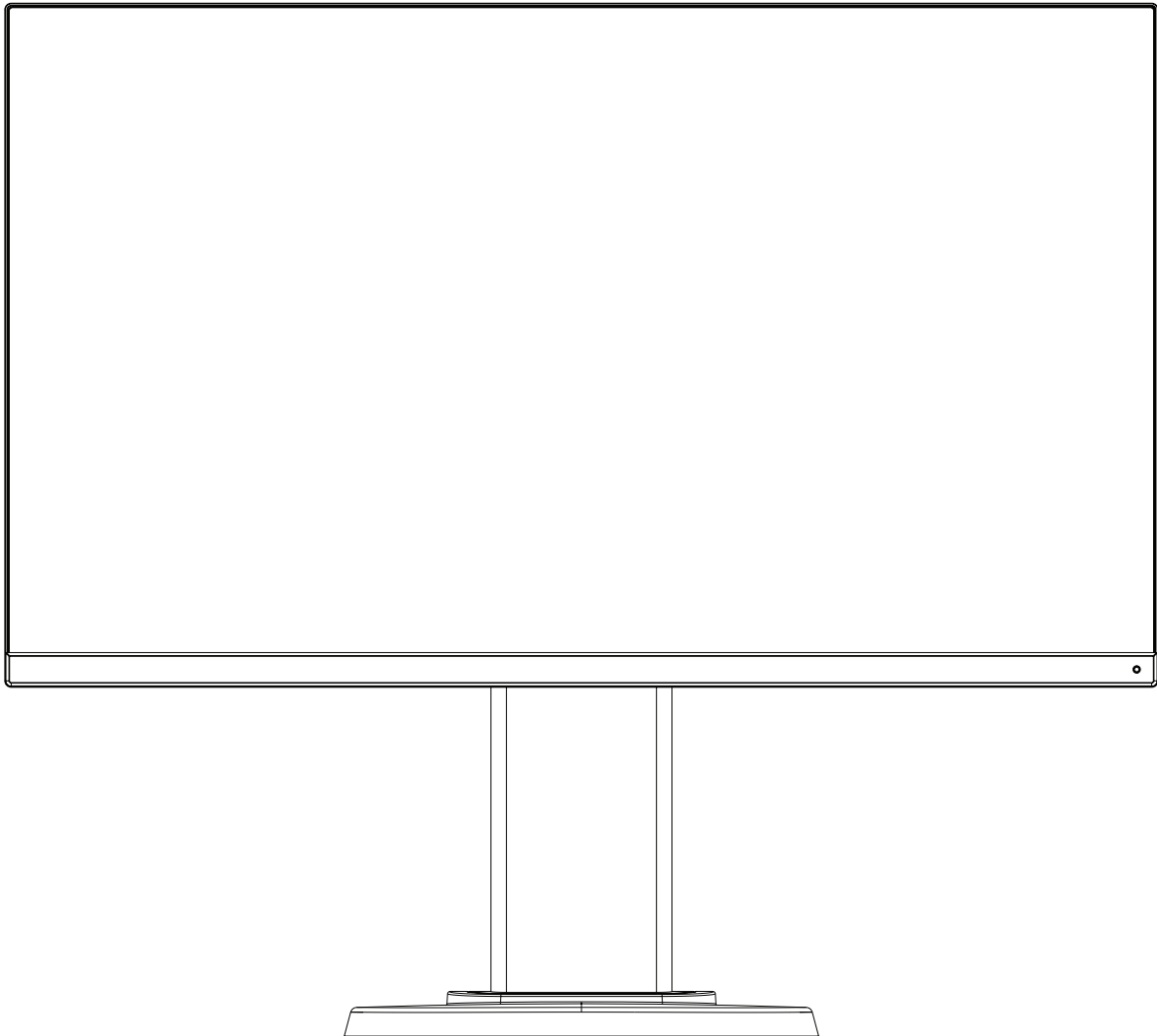

MODEL: M245AZ

Please find your model name in the label on the rear side of the monitor.

# Index

---

Important Information .....	English-1
Registration Information .....	English-3
Recommended Use.....	English-4
Parts Name and Functions.....	English-9
Quick Start.....	English-10
Controls .....	English-15
Specifications .....	English-19
Features .....	English-21
Troubleshooting.....	English-22
Manufacturer's Recycling and Energy Information.....	English-23

# Important Information



**⚠️ WARNING:** To prevent fire or shock hazards, do not expose this unit to rain or moisture.

Do not connect or disconnect this product during an electrical storm.

Also, do not use this unit's polarized plug with an extension cord receptacle or other outlets unless the prongs can be fully inserted.

Refrain from opening the cabinet as there are high voltage components inside. Refer servicing to qualified service personal.

**⚠️ CAUTION:** To reduce the risk of electric shock, make sure the power cord is unplugged from the wall socket.

To fully disengage the power to the unit, please disconnect the power cord from the AC outlet.

Do not remove cover (or back). No user serviceable parts inside.

Refer servicing to qualified service personnel.

Please use the power cord provided with this display in accordance with the power cord table. If a power cord is not supplied with this equipment, please contact NEC. For all other cases, please use the power cord with the plug style that matches the power socket where the monitor is located. The compatible power cord corresponds to the AC voltage of the power outlet and has been approved by, and complies with, the safety standards in the country of purchase.

This equipment is designed to be used in the condition of the power cord connected to the earth. If the power cord is not connected to the earth, it may cause electric shock. Please make sure the power cord is earthed properly.



This symbol warns user that uninsulated voltage within the unit may have sufficient magnitude to cause electric shock. Therefore, it is dangerous to make any kind of contact with any part inside this unit.

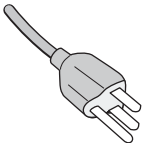
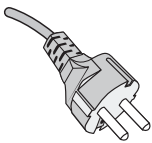
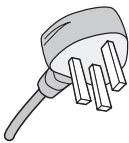
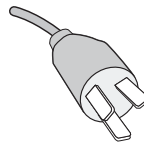
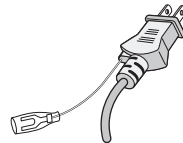

This symbol alerts the user that important literature concerning the operation and maintenance of this unit has been included. Therefore, it should be read carefully in order to avoid any problems.

Plug Type	North America	European Continental	U.K.	Chinese	Japanese
Plug Shape					
Region	U.S.A./Canada	EU	U.K.	China	Japan
Voltage	120*	230	230	220	100

\* When operating the MultiSync monitor with its AC 125-240V power supply, use a power supply cord that matches the power supply voltage of the AC power outlet being used.

**NOTE:** This product can only be serviced in the country where it was purchased.

- The intended primary use of this product is as an Information Technical Equipment in an office or domestic environment.
- The product is intended to be connected to a computer and is not intended for the display of television broadcast signals.



ENERGY STAR is a program run by the U. S. Environmental Protection Agency (EPA) and U. S. Department of Energy (DOE) that promotes energy efficiency. This product qualifies for ENERGY STAR in the "factory default" settings and this is the setting in which power savings will be achieved. Changing the factory default picture settings or enabling other features will increase power consumption that could exceed the limits necessary to qualify for ENERGY STAR rating. For more information on the ENERGY STAR program, refer to energystar.gov.

## Copyright Information

Windows is a registered trademark of Microsoft Corporation.

NEC is a registered trademark of NEC Corporation.

DisplayPort and DisplayPort Compliance Logo are trademarks owned by Video Electronics Standards Association in the United States and other countries.

MultiSync is a trademark or registered trademark of NEC Display Solutions, Ltd. in Japan and other countries.

ErgoDesign is a registered trademark of NEC Display Solutions, Ltd. in Austria, Benelux, Denmark, France, Germany, Italy, Norway, Spain, Sweden, U.K.

The terms HDMI and HDMI High-Definition Multimedia Interface, and the HDMI Logo are trademarks or registered trademarks of HDMI Licensing Administrator, Inc. in the United States and other countries.

HDCP (High-bandwidth Digital Content Protection): HDCP is a system for preventing illegal copying of video data sent over a digital signal. If you are unable to view material via the digital signal input, this does not necessarily mean the display is not functioning properly. With the implementation of HDCP, there may be cases in which certain content is protected with HDCP and might not be displayed due to the decision/intention of the HDCP community (Digital Content Protection, LLC).

All other brands and product names are trademarks or registered trademarks of their respective owners.

- NOTE:**
- (1) The contents of this user's manual may not be reprinted in part or whole without permission.
  - (2) The contents of this user's manual are subject to change without notice.
  - (3) Great care has been taken in the preparation of this user's manual; however, should you notice any questionable points, errors or omissions, please contact us.
  - (4) The image shown in this user's manual is indicative only. If there is inconsistency between the image and the actual product, the actual product shall govern.
  - (5) Notwithstanding articles (3) and (4), NEC will not be responsible for any claims on loss of profit or other matters deemed to result from using this device.



# Registration Information

## Cable Information

**CAUTION:** Use the provided specified cables with this monitor so as not to interfere with radio and television reception. For mini D-Sub 15-pin, please use a shielded signal cable with ferrite core. For HDMI, DisplayPort, USB and AUDIO, please use a shielded signal cable. Use of other cables and adapters may cause interference with radio and television reception. For detailed information, please visit our website: <https://www.nec-display.com/global/about/worldwide.html>

## FCC Information

**⚠ WARNING:** The Federal Communications Commission does not allow any modifications or changes to the unit EXCEPT those specified by NEC Display Solutions of America, Inc. in this manual. Failure to comply with this government regulation could void your right to operate this equipment.

1. The power supply cord you use must have been approved by and comply with the safety standards of U.S.A., and meet the following condition.

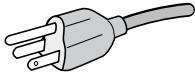
Power supply cord Plug shape	Non shield type, 3-conductor  U.S.A
---------------------------------	--

2. This equipment has been tested and found to comply with the limits for a Class B digital device, pursuant to part 15 of the FCC Rules. These limits are designed to provide reasonable protection against harmful interference in a residential installation. This equipment generates, uses and can radiate radio frequency energy, and, if not installed and used in accordance with the instructions, may cause harmful interference to radio communications. However, there is no guarantee that interference will not occur in a particular installation. If this equipment does cause harmful interference to radio or television reception, which can be determined by turning the equipment off and on, the user is encouraged to try to correct the interference by one or more of the following measures:
  - Reorient or relocate the receiving antenna.
  - Increase the separation between the equipment and receiver.
  - Connect the equipment into an outlet on a circuit different from that to which the receiver is connected.
  - Consult the dealer or an experienced radio/TV technician for help.

If necessary, the user should contact the dealer or an experienced radio/television technician for additional suggestions. The user may find the following booklet, prepared by the Federal Communications Commission, helpful: "How to Identify and Resolve Radio-TV Interference Problems." This booklet is available from the U.S. Government Printing Office, Washington, D.C., 20402, Stock No. 004-000-00345-4.

## SUPPLIER'S DECLARATION OF CONFORMITY

This device complies with Part 15 of FCC Rules. Operation is subject to the following two conditions. (1) This device may not cause harmful interference, and (2) this device must accept any interference received, including interference that may cause undesired operation.

**U.S. Responsible Party:** NEC Display Solutions of America, Inc.  
**Address:** 3250 Lacey Rd, Ste 500  
 Downers Grove, IL 60515  
 (630) 467-3000  
**Tel. No.:**  
 Type of Product: Display Monitor  
 Equipment Classification: Class B Peripheral  
 Model: MultiSync E242N (M245AZ)



To see a list of our TCO certified monitors and their TCO Certification (in English only), visit our website at [https://www.nec-display.com/global/about/legal\\_regulation/TCO\\_mn/index.html](https://www.nec-display.com/global/about/legal_regulation/TCO_mn/index.html)

**⚠ CAUTION:** Please confirm the distribution system in building installation shall provide the circuit breaker rated 120/240 V, 20 A (maximum).



# Recommended Use

## Safety Precautions and Maintenance







FOR OPTIMUM PERFORMANCE, PLEASE NOTE  
THE FOLLOWING WHEN SETTING UP AND  
USING THE LCD COLOR MONITOR:







### About the Symbols









To ensure safe and proper use of the product, this manual uses a number of symbols to prevent injury to you and others as well as damage to property. The symbols and their meanings are described below. Be sure to understand them thoroughly before reading this manual.









 <b>WARNING</b>	Failing to heed this symbol and handling the product incorrectly could result in accidents leading to major injury or death.
 <b>CAUTION</b>	Failing to heed this symbol and handling the product incorrectly could result in personal injury or damage to surrounding property.

### Examples of symbols

















	 Indicates a warning or caution. This symbol indicates you should be careful of electric shocks.
	 Indicates a prohibited action. This symbol indicates something that must be prohibited.
	 Indicates a mandatory action. This symbol indicates that the power cord should be unplugged from the power outlet.

 <b>WARNING</b>	
 <b>UNPLUG THE POWER CORD</b>	<p>Unplug the power cord if the monitor malfunctions.</p> <p>Should the monitor emit smoke or strange odors or sounds, or if the monitor has been dropped or the cabinet broken, turn off the monitor's power, then unplug the power cord from the power outlet. Failure to do so could not only lead to fire or electric shock, it could also result in vision impairment. Contact your dealer for repairs.</p> <p>Never try to repair the monitor on your own. Doing so is dangerous.</p>
	To prevent damage to the monitor caused by tipping over due to earthquakes or other shocks, make sure to install the monitor in a stable location and take measures to prevent falling.
	<p>Immediately turn off the power and unplug your monitor from the wall outlet, then refer servicing to qualified service personnel under the following conditions. If the monitor is used in this condition, the monitor may fall or cause a fire or electric shock.</p> <ul style="list-style-type: none"> <li>• If the monitor stand has cracked or peeled.</li> <li>• If you notice any structural damage such as cracks or unnatural wobbling.</li> </ul>
 	<p>Do not open the monitor.</p> <p>There are high voltage areas in the monitor. Opening or removing covers may expose you to dangerous shock hazards or other risks. Refer all servicing to qualified service personnel.</p>
	<p>Handle the power cord with care. Damaging the cord could lead to fire or electric shock.</p> <ul style="list-style-type: none"> <li>• Do not place heavy objects on the cord.</li> <li>• Do not place the cord under the monitor.</li> <li>• Do not cover the cord with a rug, etc.</li> <li>• Do not scratch or modify the cord.</li> <li>• Do not bend, twist or pull the cord with excessive force.</li> <li>• Do not apply heat to the cord.</li> </ul> <p>Should the cord be damaged (exposed core wires, broken wires, etc.), ask your dealer to replace it.</p>

 <b>WARNING</b>	
	Do not place this product on a sloping or unstable cart, stand or table, as the monitor may fall, causing serious damage to the monitor.
	Do not use the monitor if the monitor was dropped or the cabinet is damaged.
 	Do not insert objects of any kind into the cabinet slots, as they may touch dangerous voltage points, which can be harmful or fatal, or may cause electric shock, fire or equipment failure.
	Do not spill any liquids into the cabinet or use your monitor near water. Immediately turn off the power and unplug your monitor from the wall outlet, then refer servicing to qualified service personnel under the following condition. If the monitor is used in this condition, the monitor may fall or cause an electric shock or start a fire: <ul style="list-style-type: none"><li>• If liquid has spilled or objects have fallen into the monitor.</li></ul>
	The power supply cord you use must have been approved by and comply with the safety standards of your country. (e.g. Type H05VV-F 3G 0.75 mm <sup>2</sup> should be used in Europe). In the UK use a BS-approved power cord with a molded plug having a black (5 A) fuse installed for use with this monitor.
	Do not disassemble the monitor. Do not remove or open the monitor's cabinet. Do not modify the monitor. There are high voltage areas in the monitor. Modifying the monitor could lead to a fire or electric shock.
	Do not play with the plastic bag which covers the monitor. Do not use this bag for any other purpose. To avoid the danger of suffocation, do not place this bag over your head, nose or mouth. Do not place this bag over another person's head, nose or mouth. Keep this bag away from children and babies.

 <b>CAUTION</b>	
Please install the monitor in accordance with the following information. Improper installation of the monitor may result in damage to the monitor, an electric shock or fire.	
	Allow adequate ventilation around the monitor, so that heat can properly dissipate.
	Do not cover the vent on the monitor.
	Do not mount the product in any configuration or position not described in the user's manual.
	Do not place this monitor near a radiator, other heat sources, or in direct sunshine.
	Do not install in areas where the monitor will be exposed to continual vibration.
	Do not use the monitor in high temperature, humid, dusty, or oily areas.
	Do not use the monitor outdoors.

 **CAUTION**

	Do not climb on the monitor or the table where the monitor is installed. Do not install the monitor on a wheeled table if the wheels on the table have not been properly locked. The monitor may fall causing damage to the monitor or personal injury.
	Do not touch LCD panel surface while transporting, mounting and setting. Applying pressure on the LCD panel can cause serious damage.
 	If the monitor or glass breaks, do not come into contact with the liquid crystal that is inside the screen. If the liquid crystal comes into contact with your eyes or mouth, rinse thoroughly and immediately contact your doctor for help.
  	<p>Handling the power cord</p> <ul style="list-style-type: none"> <li>• When connecting the power cord to the monitor's AC IN terminal, make sure the connector is fully and firmly inserted. Loose connection of the power cord could lead to fire or electric shock.</li> <li>• Do not connect or disconnect the power cord with wet hands. Doing so could result in electric shock.</li> <li>• When connecting or disconnecting the power cord, pull the power cord out by holding onto its plug. Do not pull the power cord out by holding onto its cable. Pulling the power cord out of the wall by holding onto the cable can damage the power cord, which could lead to fire or electric shock.</li> <li>• When cleaning the monitor, for safety purposes unplug the power cord from the power outlet beforehand.</li> <li>• Before moving the monitor, make sure the monitor power is off, then unplug the power cord from the power outlet and check that all cables connecting the monitor to other devices are disconnected.</li> <li>• When you are not planning to use the monitor for an extended period of time, always unplug the power cord from the power outlet.</li> </ul>
	<p>Handle with care when transporting.</p> <ul style="list-style-type: none"> <li>• To safely transport and securely install the monitor, please use as many people as necessary to be able to lift the monitor without causing personal injury or damage to the monitor.</li> </ul>
	To ensure the monitor's reliability, please clean the ventilation holes at the rear side of the cabinet at least once a year to remove dirt and dust.
	Regularly dust off the power cord by using a soft dry cloth. Dust build-up on the power cord's plugs and cable could cause an electric shock and result in a fire.
	Handle with care during installation and adjustment to prevent personal injury and damage to the monitor.
	<p>The monitor must be mounted to a flexible arm or stand that supports the weight of the monitor to prevent damage and personal injury that could result from the monitor tipping over or falling.</p> <ul style="list-style-type: none"> <li>• Please tighten all screws when installing the monitor to a flexible arm or stand. A loose screw may cause the monitor to fall, causing damage to the monitor or personal injury.</li> </ul>
 	<p>Clean the monitor's LCD screen surface with a lint-free, non-abrasive cloth.</p> <p>Avoid using any cleaning solutions! DO NOT clean with benzene thinner, alkaline detergent, alcoholic system detergent, glass cleaner, wax, polish cleaner, soap powder, or insecticide. Rubber or vinyl should not be in contact with the cabinet for an extended period of time. These types of fluids and materials can cause the paint to deteriorate, crack or peel.</p>
	Do not connect headphones to the monitor while you are wearing them. Depending on the volume level, it may damage your ears and cause loss of hearing.
	Do not bind the USB cable. It may trap heat and cause a fire.



**Image Persistence**

Image persistence occurs when a residual or “ghost” image of a previous image remains visible on the screen. Unlike CRT monitors, LCD monitors’ image persistence is not permanent, but a still image being displayed for a long period of time should be avoided.

To alleviate image persistence, turn off the monitor for as long as the previous image was displayed. For example, if an image was on the monitor for one hour and a residual image remains, the monitor should be turned off for one hour to erase the image.

**NOTE:** As with all personal display devices, NEC DISPLAY SOLUTIONS recommends using a moving screen saver at regular intervals whenever the screen is idle, or turn off the monitor when not in use.

## Ergonomics

### CORRECT PLACEMENT AND ADJUSTMENT OF THE MONITOR CAN REDUCE EYE, SHOULDER, AND NECK FATIGUE. CHECK THE FOLLOWING WHEN YOU POSITION THE MONITOR:

To realize the maximum ergonomics benefits, we recommend the following:

- For optimum performance of the monitor, allow 20 minutes for warming up. Avoid reproduction of still patterns on the monitor for long periods of time to avoid image persistence (after image effects).
- Adjust the monitor height so that the top of the screen is at or slightly below eye level. Your eyes should look slightly downward when viewing the middle of the screen.
- Position your monitor no closer than 40 cm (15.75 inches) and no further away than 70 cm (27.56 inches) from your eyes. The optimal distance is 50 cm (19.69 inches).
- Rest your eyes periodically for 5 to 10 minutes for every 1 hour by focusing on an object at least 20 feet away.
- Position the monitor at a 90° angle to windows and other light sources to minimize glare and reflections. Adjust the monitor tilt so that ceiling lights do not reflect on your screen.
- If reflected light makes it hard for you to see your screen, use an anti-glare filter.
- Adjust the monitor's brightness and contrast controls to enhance readability.
- Use a document holder placed close to the screen.
- Position whatever you are looking at most of the time (the screen or reference material) directly in front of you to minimize turning your head while you are typing.
- Blink often. Eye exercise helps to reduce eye strain. Please contact your ophthalmologist. Get regular eye checkups.
- To avoid eye fatigue, adjust the brightness to a moderate setting. Place a sheet of white paper next to the LCD screen for luminance reference.
- Do not position the Contrast control to its maximum setting.
- Use the preset Size and Position controls with standard signals.
- Use the preset Color Setting.
- Use non-interlaced signals.
- Do not use primary color blue on a dark background, as it is difficult to see and may produce eye fatigue due to insufficient contrast.
- Suitable for entertainment purposes at controlled luminous environments, to avoid disturbing reflections from the screen.

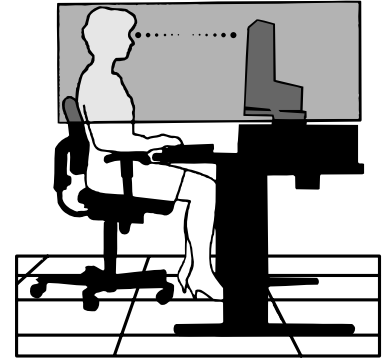

For more detailed information on setting up a healthy work environment, write to the American National Standard for Human Factors Engineering of Computer Workstations - ANSI/HFES 100-2007 - The Human Factors Society, Inc. P.O. Box 1369, Santa Monica, California 90406.

### Cleaning the LCD Panel

- When the LCD is dusty, please gently wipe with a soft cloth.
- Please do not rub the LCD panel with hard or coarse material.
- Please do not apply pressure to the LCD surface.
- Please do not use OA cleaner as it will cause deterioration or discoloration on the LCD panel surface.

### Cleaning the Cabinet

- Unplug the power supply.
- Gently wipe the cabinet with a soft cloth.

Dampen the cloth with a neutral detergent and water, wipe the cabinet and follow with a dry cloth.

# Parts Name and Functions

## Control Panel

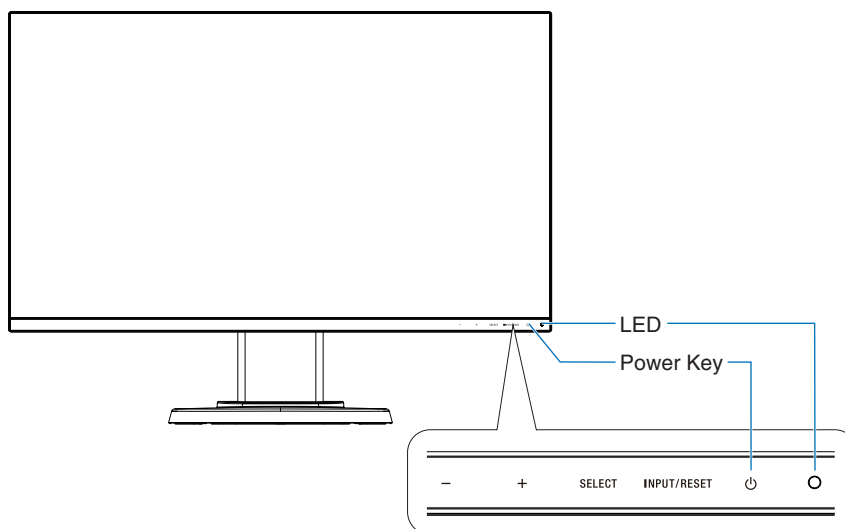

## Control Keys

Refer to the **Controls** section. See [page 15](#).

## Terminal Panel

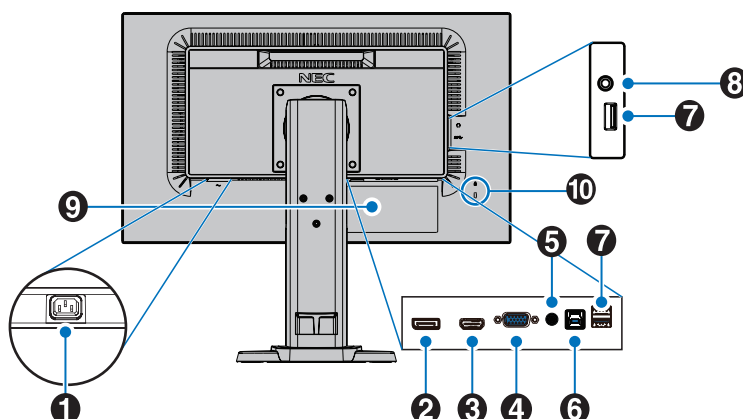

### 1 AC IN Connector

Connects with the supplied power cord.

### 2 DisplayPort IN

DisplayPort signals input.

### 3 HDMI IN

HDMI signals input.

### 4 VGA IN (mini D-Sub 15-pin)

Analog RGB signals input.

### 5 Audio IN

Audio signal input from external equipment such as a computer or player.

### 6 USB Upstream Port (Type-B)

Connects with external equipment such as a computer. Please use this port to control the monitor from connected external equipment.

### 7 USB Downstream Port (Type-A)

Connects with USB devices. Connects with external equipment such as a computer compliant with USB.

### 8 Headphone Jack

Connects with headphones.

**⚠ CAUTION:** Do not connect headphones to the monitor while you are wearing them. Depending on the volume level, it may damage your ears and cause loss of hearing.

### 9 Rating Label

### 10 Security Slot

Security and theft protection lock slot compatible with Kensington cables/equipment. For products visit Kensington's website.

# Quick Start

For box contents, please refer the printed contents sheet provided in the box.

To attach the base to the monitor stand:

1. Place monitor face down on a non-abrasive surface (**Figure 1**).
2. Please rotate the monitor stand 90 degrees as shown in **Figure 1**.

**CAUTION:** Handle with care when pulling the monitor stand. It may pinch your fingers.

3. Attach the base to the monitor stand, then tighten the screw at the base's bottom (**Figure 2**).

**NOTE:** Reverse this procedure if you need to re-pack the monitor.

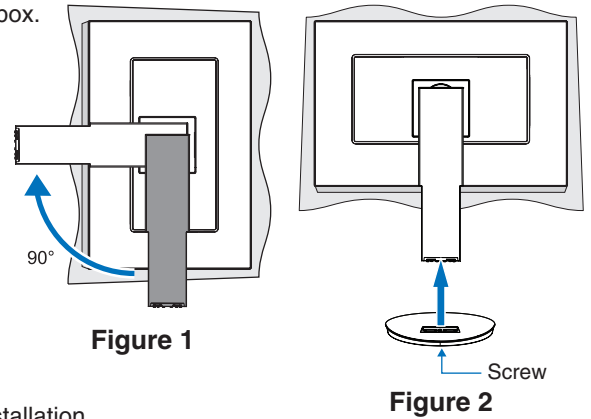

To connect the LCD monitor to your system, follow these instructions:

**NOTE:** Make sure to read "Recommended Use" ([page 4](#)) before installation.

**CAUTION:** Please tighten all screws.

**NOTE:** The accessories included will depend on the location where the LCD monitor was shipped.

1. Turn off the power for your computer.
2. **For a PC with DisplayPort output:** Connect the DisplayPort cable to the connector of the display card in your system (**Figure A.1**).

**For a PC with HDMI output:** Connect the HDMI cable to the connector of the display card in your system (**Figure A.2**).

**For a PC with Analog output:** Connect a 15-pin mini D-SUB signal cable to the connector of the display card in your system (**Figure A.3**). Tighten all screws.

**For a Mac or PC with Thunderbolt or Mini DisplayPort output:** Connect a Mini DisplayPort to DisplayPort cable to the video output connector on your system (**Figure A.4**).

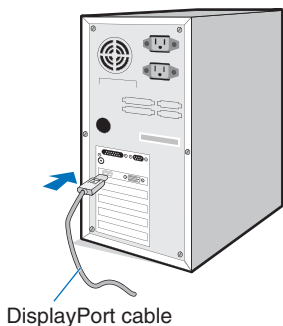

**Figure A.1**

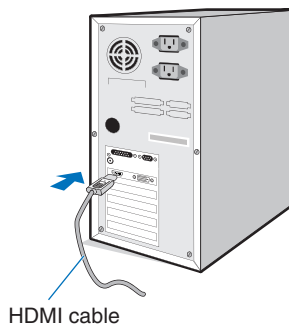

**Figure A.2**

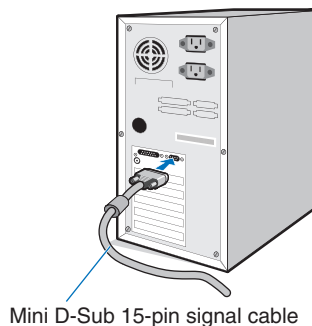

**Figure A.3**

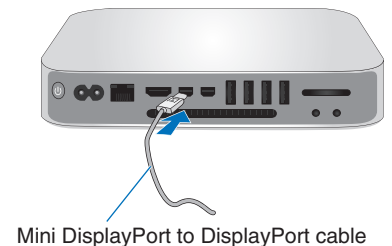

**Figure A.4**

**NOTE:**

- When removing the DisplayPort cable, hold down the top button to release the lock.
- Please use a High Speed HDMI cable with HDMI logo.
- Please use a Certified DisplayPort cable.

**CAUTION:** Use the provided specified cables with this monitor so as not to interfere with radio and television reception. For mini D-Sub 15-pin, please use a shielded signal cable with ferrite core. For HDMI, DisplayPort, USB and AUDIO, please use a shielded signal cable. Use of other cables and adapters may cause interference with radio and television reception.

- Place hands on each side of the monitor screen, tilt the screen to the maximum tilt angle, then lift the screen to the highest position.
- Connect all cables to the appropriate connectors (**Figure C.1**). When using the USB cable, connect the Type-B connector to the USB upstream port on the rear side of the monitor and the Type-A connector to the downstream port on the computer (**Figure C.1a**). If using the cord from a USB device, plug it into the downstream port of the monitor.

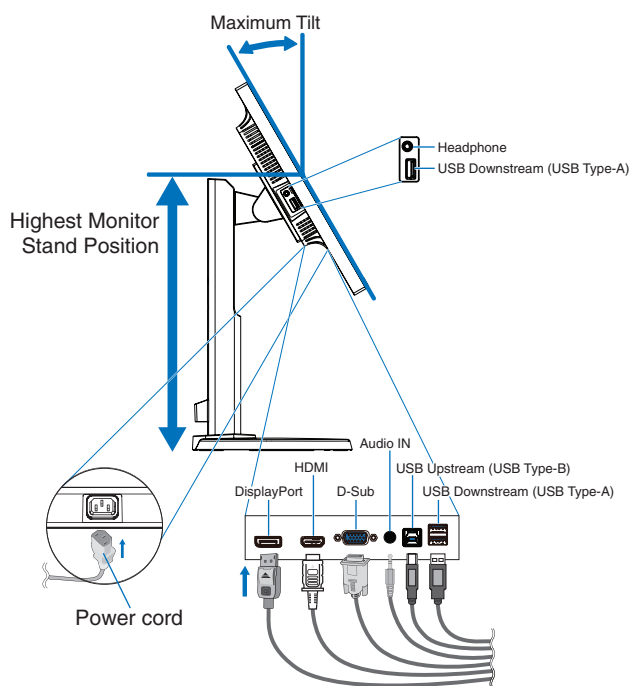

**Figure C.1**

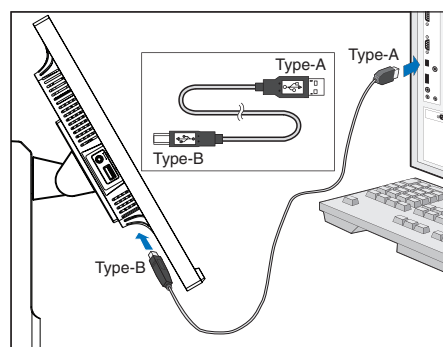

**Figure C.1a**

**NOTE:** Incorrect cable connections may cause abnormal operation, damage display quality/components of the LCD panel and/or shorten the module's life.

**CAUTION:** Do not bind the USB cable. It may trap heat and start a fire.

**NOTE:** Do not use an attenuating (built-in resistor) audio cable. Using an audio cable with a built-in resistor will lower the sound level.

**NOTE:** Adjustment of the volume control as well as the equalizer to settings other than the center position may increase the ear-/headphones output voltage and therefore the sound pressure level.

- Place the cables into the cable management system that is built into the monitor stand firmly and evenly (**Figure C.2** and **Figure C.3**).
- Please check that you can still rotate, raise and lower the monitor screen after you have installed the cables.

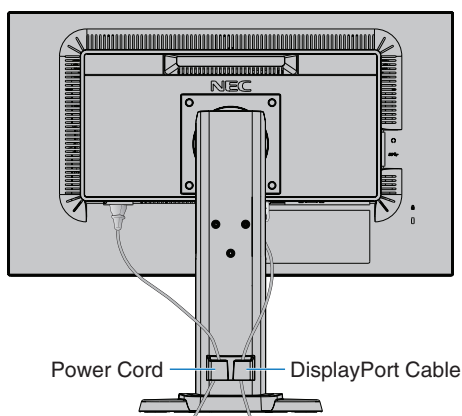

**Figure C.2**

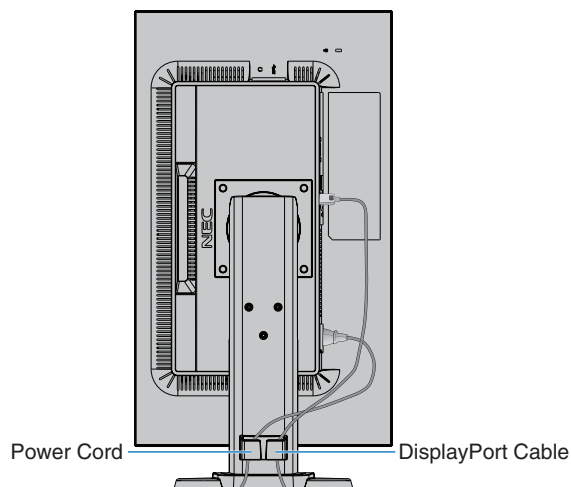

**Figure C.3**

- Connect the power cord to the power outlet.

**NOTE:** Please refer to the **Important Information** section of this manual for proper selection of the AC power cord.

8. Turn on the monitor by touching the  key and then the computer (**Figure E.1**).
9. When using analog (VGA) input, No Touch Auto Adjust automatically adjusts the monitor to optimal settings upon initial setup. For further adjustments, use the following OSD controls:
  - AUTO CONTRAST
  - AUTO ADJUST

Refer to the **Controls** section of this User's Manual for a full description of these OSD controls.

**NOTE:** If you have any problems, please refer to the **Troubleshooting** section of this User's Manual.

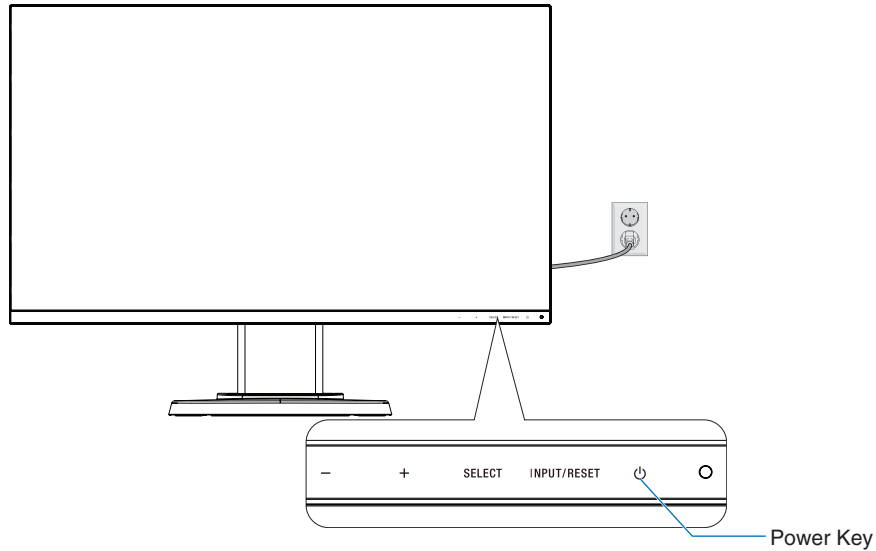

**Figure E.1**

## Adjustable monitor stand with pivot capability

**Raise and Lower:** Hold the monitor on each side and lift or lower to the desired height.

**Tilt and Swivel:** Hold the top and bottom sides of the monitor screen with your hands and adjust the tilt and swivel as desired.

**Screen Rotation (Pivot):** Hold each side of the monitor screen, lift to its maximum height and tilt to its maximum tilt angle, then rotate the screen from landscape to portrait.

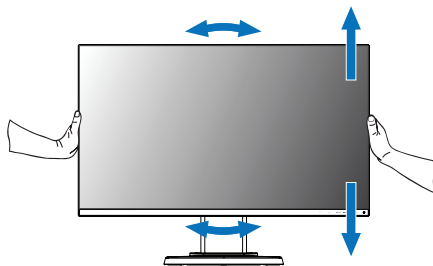

**Rotation, Raise and Lower**

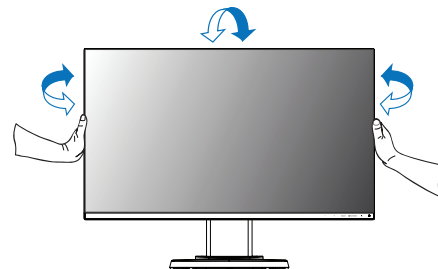

**Tilt and Swivel**

**⚠ CAUTION:** Handle with care when adjusting the monitor screen. Do not apply pressure to the LCD when adjusting the height and rotating the monitor screen. Before rotating, disconnect the power cord and all cables from the display. The screen must be raised to the highest level and adjusted to maximum tilt to avoid knocking the screen on the desk or pinching your fingers.

## Flexible Arm Installation

This LCD monitor is designed for use with a flexible arm. Contact NEC for more information.

To prepare the monitor for alternate mounting purposes:

- Follow the instructions provided by the manufacturer of the display mount.
- CAUTION:** To meet the safety requirements, the monitor must be mounted to an arm that supports the weight of the monitor. See [page 19](#) for details. Remove the monitor stand before mounting.

### Remove the Monitor Stand for Mounting

To prepare the monitor for alternate mounting purposes:

- Disconnect all cables.
- Place your hands on each side of the monitor and lift up to the highest position.
- Place the monitor face down on a non-abrasive surface (**Figure S.1**).

**NOTE:** Handle with care when the monitor is facing down.

- Remove the 4 screws connecting the monitor stand to the monitor (**Figure S.1**).

**NOTE:** Please securely hold the monitor stand while removing the screws to prevent the monitor stand from falling.

- Remove the monitor stand (**Figure S.2**).

**NOTE:** Use only VESA-compatible alternative mounting method. Handle with care when removing the monitor stand.

- The monitor is now ready for mounting in an alternate manner.

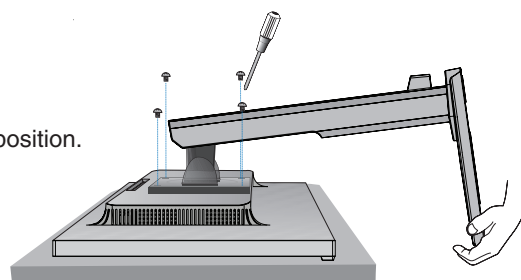

Figure S.1

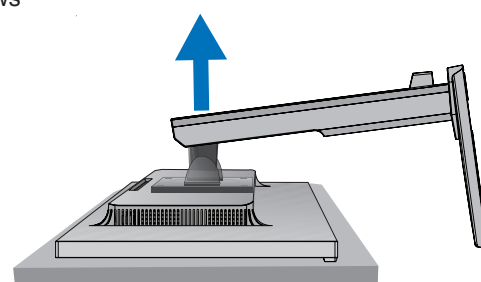

Figure S.2

### Mount Flexible Arm

This LCD monitor is designed for use with a flexible arm.

- Follow the instructions on how to [Remove the Monitor Stand for Mounting](#).
- Using 4 screws that meet the specifications listed below, attach the arm to the monitor (**Figure F.1**).

- CAUTION:**
  - Only use the screws (4 pcs) that were removed from the monitor stand or the specified screws (**Figure F.1**) to avoid damage to the monitor or monitor stand.
  - To meet the safety requirements, the monitor must be mounted to an arm which guaranties the necessary stability under consideration for the weight of the monitor. The LCD monitor should only be used with an approved arm (e.g. TUEV GS mark).
  - Tighten all screws (recommended Fasten Force: 98 - 137N•cm). A loose screw may cause the monitor to fall off the arm.
  - Attaching the flexible arm should be done by two or more people if the monitor cannot be placed face down on a flat surface for installation.

- Connect the cables to the rear side of the monitor.

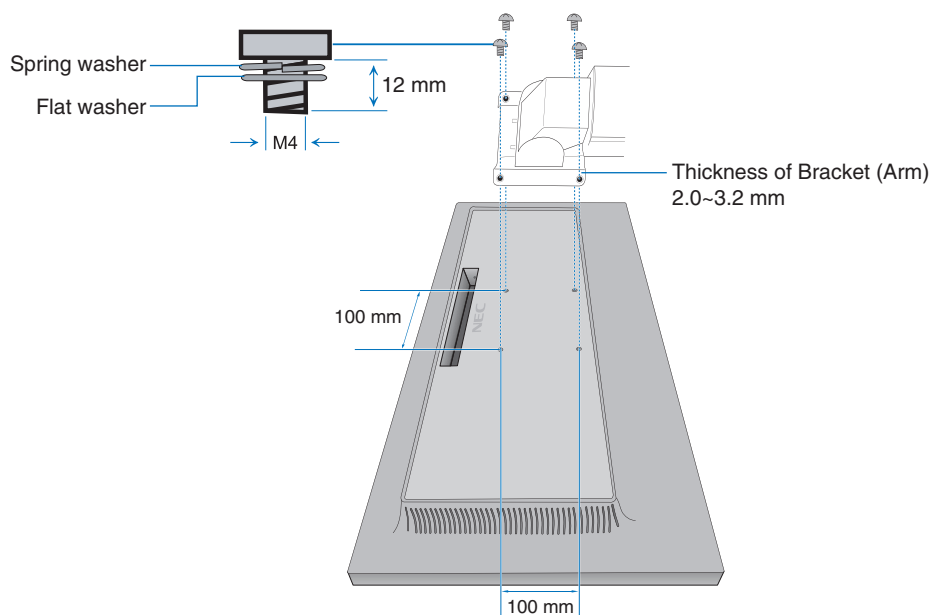
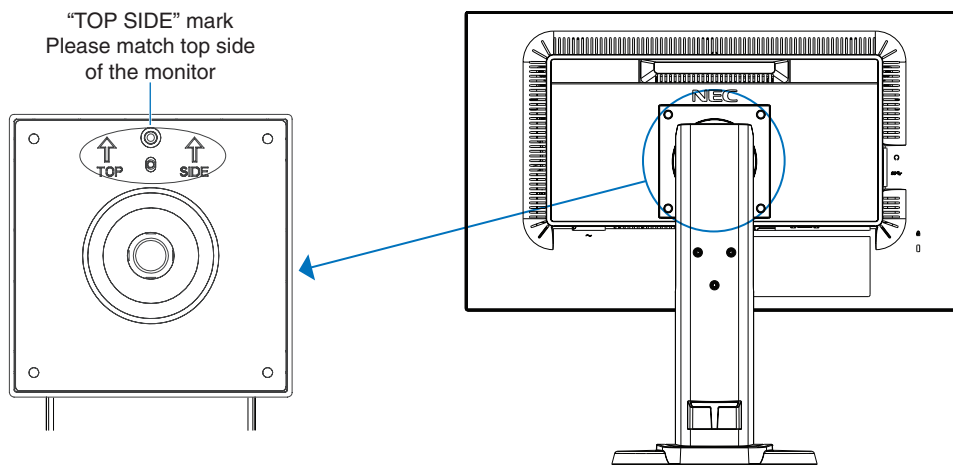

Figure F.1

## Re-attaching the original monitor stand

Reverse the process in the previous section to re-attach the monitor stand.

**NOTE:** Match "TOP SIDE" mark on the monitor stand to top side of the monitor when re-attaching the monitor stand.





# Controls

## OSD (On-Screen Display) Control Functions

### 1. Basic functions of the touch keys on the front of the monitor

OSD Menu	-	+	SELECT	INPUT/RESET
Not displaying on screen	Shortcut to [BRIGHTNESS].	Shortcut to [VOLUME].	Displays OSD.	Selects input signal.
Displaying on screen Icon Select	Moves leftward.	Moves rightward.	Displays OSD menu and selects function icon.	
Displaying on screen Function Adjustment	Adjusts down.	Adjusts up.	Adjusts the function of the selected icon.	Resets the function.

**NOTE:** You can directly change to [LOW BLUE LIGHT MODE] by touching the SELECT key for 3 seconds or more.

### 2. OSD structure

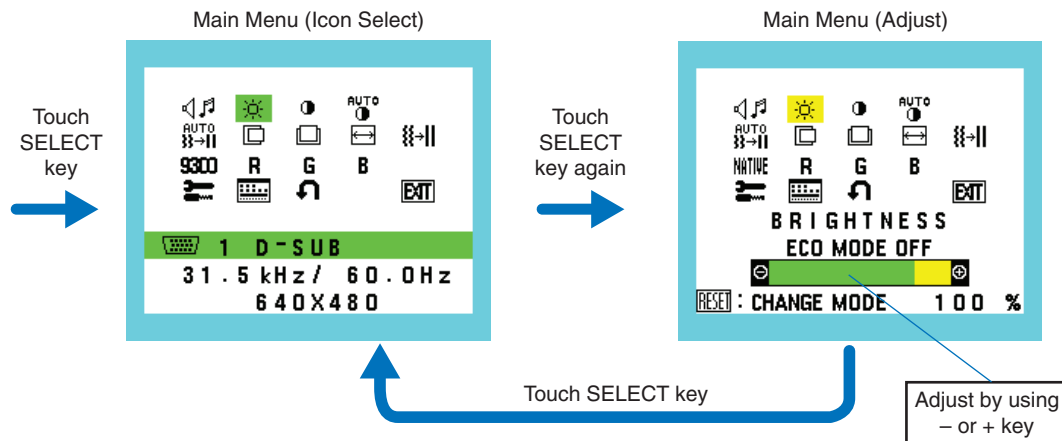

Example: [TOOL] sub menu

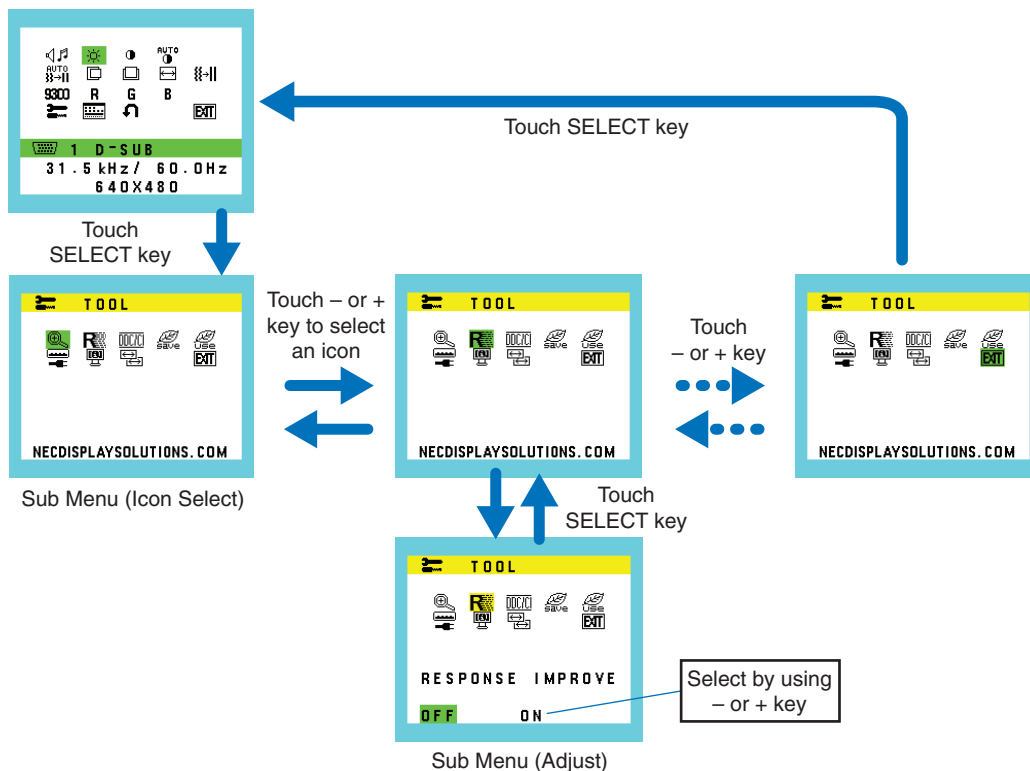



## VOLUME

Controls the volume of the speakers or headphones.  
To mute the speaker output select Audio icon and touch INPUT/RESET key.



## BRIGHTNESS

Adjusts the overall image and background screen brightness.  
Touch INPUT/RESET key to enter [ECO MODE].  
**ECO MODE OFF:** Sets brightness variable from 0% to 100%.  
**ECO MODE1:** Sets brightness 70%.  
**ECO MODE2:** Sets brightness 30%.  
**NOTE:** When [DV MODE] is [ON], [ECO MODE] is set to [OFF] and cannot be changed.



## CONTRAST

Adjusts the image brightness in relation to the background.  
To enter the [DV MODE] setting, touch the INPUT/RESET key.  
**DV MODE:** Setting that adjusts the brightness by detecting the screen's black areas and optimizes it.  
**NOTE:** [OFF] is used for TCO Certificate compliance.



## AUTO CONTRAST (Analog input only)

Automatically adjusts the image displayed for non-standard video inputs.



## AUTO ADJUST (Analog input only)

Automatically adjusts the image position, the [H.SIZE] and [FINE] settings.



## LEFT/RIGHT (Analog input only)

Controls horizontal image position within the display area of the LCD.



## DOWN/UP (Analog input only)

Controls vertical image position within the display area of the LCD.



## H. SIZE (Analog input only)

Adjusts the horizontal size by increasing or decreasing the setting.



## FINE (Analog input only)

Improves focus, clarity and image stability by increasing or decreasing this setting.



## COLOR

Six color presets (9300 / 7500 / sRGB / USER / NATIVE / L/B) select the desired color setting.  
**NOTE:** You can directly change to [L/B] (LOW BLUE LIGHT MODE) by touching the SELECT key for 3 seconds or more.  
For changing to other settings from [L/B] mode, touch the SELECT key to show OSD menu and enter [COLOR].  
When [L/B] is selected in [COLOR] control, [CONTRAST] and [DV MODE] are disabled.



## RED

Increases or decreases [RED]. The change will appear on screen.



## GREEN

Increases or decreases [GREEN]. The change will appear on screen.



## BLUE

Increases or decreases [BLUE]. The change will appear on screen.



## TOOL

Selecting [TOOL] allows you to get into the sub menu. See [page 17](#).



## OSD TOOL

Selecting [OSD TOOL] allows you to get into the sub menu. See [page 18](#).



## FACTORY PRESET

Selecting [FACTORY PRESET] allows you to reset all OSD control settings back to the factory settings except [MUTE], [CARBON SAVINGS], [CARBON USAGE], and [SIGNAL INFORMATION]. Individual settings can be reset by highlighting the control to be reset and touching the INPUT/RESET key.



## EXIT

Selecting [EXIT] allows you to exit OSD menu/sub menu.

## TOOL



### EXPANSION

Selects the zoom mode.

This function works when the input signal timing is under native resolution.

**FULL:** The image is expanded to full screen, regardless of the resolution.

**ASPECT:** The image is expanded without changing the aspect ratio.



### RESPONSE IMPROVE

Turns the [RESPONSE IMPROVE] function [ON] or [OFF].

This function may reduce blurring that occurs in some moving images.



### DDC/CI

This function turns the [DDC/CI] function [ON] or [OFF].



### USB POWER

Selects how power through the USB port is enabled in relation to the monitor's power status.

**AUTO:** Power is supplied to the USB downstream port depending on the monitor's power condition.

**ON:** Power is always supplied to the USB downstream port even when the monitor is in power save mode or power OFF.

**NOTE:** Power consumption depends on the connected USB device even when a monitor's power is off.



### CARBON SAVINGS

Displays the estimated carbon saving information in kg.

The carbon footprint factor in the carbon saving calculation is based on the OECD data (2008 Edition).

The carbon saving information can be reset by touching the INPUT/RESET key.



### CARBON USAGE

Displays the estimated carbon usages information in kg.

This is an arithmetic estimation, not actual measurement value.

The carbon footprint factor in the carbon usage calculation is based on the OECD data (2008 Edition).

The carbon usage information can be reset by touching the INPUT/RESET key.



### MONITOR INFO

Indicates the model and serial numbers of your monitor.



### SOUND INPUT (HDMI, DisplayPort inputs only)

Selects the sound input source.



### INPUT RESOLUTION (Analog input only)

This function works when the user selects one of the special input signal timings below.

Select one of the following pair of resolutions as the input signal priority:

1280 x 768 or 1360 x 768 or 1366 x 768 (vertical resolution 768),

1600 x 900 or 1280 x 960 (horizontal frequency 60 kHz, vertical frequency 60 Hz),

1400 x 1050 or 1680 x 1050 (vertical resolution 1050).

## OSD TOOL



### LANGUAGE

Selects the language used by the OSD.



### OSD TURN OFF

The OSD menu will stay on as long as it is in use. You can select how long the monitor waits after the last key touch to shut off the OSD menu. The preset choices are 10-120 seconds by 5-second increments.



### OSD LOCK OUT

This control completely locks out the access to all OSD control functions except for [VOLUME], [BRIGHTNESS] and [CONTRAST].

To activate the [OSD LOCK OUT] function, enter the [OSD TOOL] sub menu, select [OSD LOCK OUT], touch and hold the INPUT/RESET and + keys simultaneously until "OSD LOCKED OUT" indicator appears.

To deactivate, touch the SELECT key, then repeat the same steps until the OSD main menu displays on screen.



### SIGNAL INFORMATION

If you select [ON], the monitor displays "VIDEO INPUT" after changing the input.

**NOTE:** The compliance marks that are shown when powering on the monitor the first time are not shown when switching inputs.

The compliance marks are not shown again unless the AC power cord has been disconnected and reconnected.

If you select [OFF], the monitor does not display "VIDEO INPUT" after changing the input.

**NOTE:** Setting [OFF] also prevents the compliance marks from being shown when powering on the monitor.

## OSD Warning

OSD warning message close by touching the SELECT key.

**NO SIGNAL:** This function gives a warning when there is no signal present. After power is turned on or when there is a change of input signal or video is inactive, the "**NO SIGNAL**" window will appear.

**OUT OF RANGE:** This function gives a recommendation of the optimized resolution and refresh rate. After the power is turned on or there is a change of input signal or the video signal doesn't have proper timing, the "**OUT OF RANGE**" message will appear.

# Specifications

Monitor Specifications		MultiSync E242N Monitor	Notes
LCD Module	Diagonal: Viewable Image Size: Native Resolution (Pixel Count):	60.47 cm/23.8 inches 60.47 cm/23.8 inches 1920 x 1080	Active matrix; thin film transistor (TFT) liquid crystal display (LCD); 0.275 mm dot pitch; 250 cd/m <sup>2</sup> white luminance; 1000:1 contrast ratio (typical), (5000:1 Contrast ratio, DV MODE ON).
Input Signal			
DisplayPort:	DisplayPort Connector:	Digital RGB	DisplayPort V1.1a (HDCP 1.3)
VGA:	Mini D-Sub 15-pin:	Analog RGB Sync	0.7 Vp-p/75 ohm Separate sync.TTL level Positive/Negative
HDMI:	HDMI Connector:	Digital YUV Digital RGB	HDMI (HDCP 1.4)
Display Colors		16,777,216	Depends on display card used.
Synchronization Range	Horizontal: Vertical:	31.5 kHz to 83.0 kHz 56 Hz to 75 Hz	Automatically Automatically
Response Time		6 ms (Gray to gray Typ.)	
Viewing Angle	Left/Right: Up/Down:	±89° (CR > 10) ±89° (CR > 10)	
Active Display Area	Landscape: Horiz.: Vert.: Portrait: Horiz.: Vert.:	527.04 mm/20.7 inches 296.46 mm/11.7 inches 296.46 mm/11.7 inches 527.04 mm/20.7 inches	
USB Hub	I/F: Port: Load Current:	SuperSpeed USB (USB 3.1 Gen 1) Upstream 1 Downstream 3 5 V/0.9 A (Max.)	Upstream port applicable to USB monitor control.
AUDIO			
AUDIO Input:	STEREO Mini Jack: DisplayPort Connector: HDMI Connector:	Analog Audio Digital Audio Digital Audio	Stereo L/R 0.5 Vrms 20 Kohm PCM 2ch 32, 44.1, 48 kHz (16/20/24bit) PCM 2ch 32, 44.1, 48 kHz (16/20/24bit)
Headphone Output:	STEREO Mini Jack:		Headphone Impedance 32 Ohm
Speakers	Practical Audio Output:	1.0 W + 1.0 W	
Power Supply		100 - 240 V, 50/60 Hz	
Current Rating		0.80 - 0.45 A	
Dimensions	Landscape: Portrait:	538.6 mm (W) x 373.9 - 483.9 mm (H) x 213.9 mm (D) 21.2 inches (W) x 14.7 - 19.1 inches (H) x 8.4 inches (D) 319.4 mm (W) x 555.1 - 593.2 mm (H) x 213.9 mm (D) 12.6 inches (W) x 21.9 - 23.4 inches (H) x 8.4 inches (D)	
Monitor Stand Adjustable Range	Height Adjustment: Tilt / Pivot / Swivel:	110 mm/4.3 inches (Landscape orientation) 38.0 mm/1.5 inches (Portrait orientation) Up 25° Down 5° / ± 90° / 90°	
Weight		5.6 kg (12.3 lbs) (with monitor stand)/3.6 kg (7.9 lbs.) (without monitor stand)	
Environmental Considerations			
	Operating Temperature: Humidity: Altitude:	5°C to 35°C/41°F to 95°F 20% to 80% 0 to 6,562 Feet/0 to 2,000 m	
	Storage Temperature: Humidity: Altitude:	-10°C to 60°C/14°F to 140°F 10% to 85% 0 to 40,000 Feet/0 to 12,192 m	

**NOTE:** Technical specifications are subject to change without notice.

## Major supported timings

Resolution		Vertical Frequency	Scan Type	Notes
H	V			
640	x 480	60/72/75 Hz	P	
720	x 400	70 Hz	P	
720	x 480	60 Hz	P	
720	x 576	50 Hz	P	
800	x 600	56/60/72/75 Hz	P	SVGA
1024	x 768	60/70/75 Hz	P	XGA
1280	x 720	50/60 Hz	P	HD 720
1280	x 960	60/75 Hz	P	Quad-VGA
1280	x 1024	60/75 Hz	P	SXGA
1440	x 900	60 Hz	P	WXGA+
1680	x 1050	60 Hz	P	WSXGA+
1920	x 1080	50 Hz	P	FHD
1920	x 1080	60 Hz	P	FHD Recommend

*p: Progressive.*

**NOTE:** When the selected monitor resolution is not a native panel resolution, the text contents appearance in the monitor screen is expanded in a horizontal or vertical direction to show the non-native resolution to full screen. This expansion is done by interpolated resolution technologies, which are normal and widely used in flat panel devices.

# Features

---

**3-side Narrow Bezel:** Stylish appearance and less distance between adjacent screens in a multi-monitor setup.

**SuperSpeed USB Hub:** The USB hub adds flexibility to your computing by providing easy access to SuperSpeed USB data transfer and charging via USB. For more details, please see [page 19](#).

**Various Signal Interfaces:** This model has various interfaces. For more detail, please see [page 11](#).

**Fully Ergonomic Monitor Stand:** Provides viewing flexibility with 110 mm height adjustment, -5 ~ 25-degree tilt, 45-degree swivel to both right/left directions, with cable management and a small footprint. The ability to pivot to either side can minimize width between adjacent bezels in multi-monitor installations. The bottom of the monitor cabinet can touch the monitor stand base for lower positioning requirements.

**ErgoDesign Features:** Enhance human ergonomics to improve the working environment, protect the health of the user and save money. The ergonomic features include a fully articulating monitor stand, OSD controls for quick and easy image adjustment, and lower emissions.

**VESA Plate for Thin Client Computer\*:** Provides the ability to mount a thin client computer on the monitor stand pole using the included VESA plate.

**VESA Standard Mounting Interface:** Connects the monitor to any VESA standard third party mounting arm or bracket.

**Color Control Systems:** Adjusts the colors on the screen and allows customization of the color accuracy of the monitor to a variety of standards.

**OSD (On-Screen Display) Controls:** Provides access for quick and easy adjustment to all elements of the screen image via simple to use on-screen menus.

**NaViSet Administrator 2 Software:** Offers an expanded and intuitive graphical interface, allowing adjustments of the OSD display settings from a network PC.

**No Touch Auto Adjust (Analog input only):** Automatically adjusts the monitor to optimal settings upon initial setup.

**Plug and Play:** The Microsoft® solution with the Windows® operating system facilitates setup and installation by allowing the monitor to send its capabilities (such as screen size and resolutions supported) directly to the computer, automatically optimizing display performance.

**Intelligent Power Manager System:** Provides innovative power-saving methods that allow the monitor to shift to a lower-power mode when on but not in use, reducing emissions and lowering the cost of operating the monitor by reducing its power consumption.

**FullScan Capability:** Allows use of the entire screen area in most resolutions, significantly expanding the image size.

**Low Blue Light:** Low Blue Light function substantially reduces blue light and helps to alleviate eye-strain (see [page 16](#)).

**Flicker Free:** Special backlight system reduces flicker for less eyestrain.

**Environmental Impact:** Annual typical maximum operating carbon footprint of this monitor (world-wide average) is approximately 35.5 kg (calculated by: rated wattage x 8 hours per day x 5 days a week x 45 weeks per year x Power-to-Carbon conversion factor - conversion factor is based on OECD publication of global CO2 emissions 2008 Edition).

This monitor has a manufacturing carbon footprint of approximately 59.8 kg.

**Note:** The manufacturing and operating carbon footprints are calculated by a unique algorithm developed exclusively by NEC for its monitors and are accurate at the time of printing. NEC reserves the right to publish updated carbon footprint values.

\* Depending on the country where the LCD monitor is shipped to, the VESA Plate is not included in the box contents.

# Troubleshooting

---

## No picture

- Make sure the signal cable is fully connected to both the monitor and the computer.
- Make sure the computer's display card is fully seated in its slot.
- Do not use a DisplayPort converter adapter. This device is not supported.
- Make sure both the computer and monitor power switches are in the ON position.
- Make sure that a Major Supported Timings has been selected for the display card in the system being used. (Please consult the manual for the system or display card for supported resolution and changing the settings.)
- Check the monitor and your display card with respect to compatibility and recommended settings.
- Check the signal cable connector for bent or pushed-in pins.
- Make sure the connected device outputs a signal to the monitor.

## Power key does not respond

- Unplug the monitor's power cord from the AC outlet to reset the monitor.

## Image persistence

- Image persistence is when a residual or "ghost" image of a previous image remains visible on the screen. Unlike CRT monitors, LCD monitors' image persistence is not permanent, but constant images being displayed for a long period of time should be avoided. To alleviate image persistence, turn off the monitor for as long as the previous image was displayed. For example, if an image was on the monitor for one hour and a residual image remains, the monitor should be turned off for one hour to erase the image.

**NOTE:** As with all personal display devices, NEC DISPLAY SOLUTIONS recommends using a moving screen saver at regular intervals whenever the screen is idle or turning off the monitor when not in use.

## Message "OUT OF RANGE" is displayed (screen is either blank or shows rough images only)

- OSD warning "OUT OF RANGE" is displayed on a rough image (pixels are missing): Either the signal clock or resolution is too high. Change the settings to a supported mode.
- OSD warning "OUT OF RANGE" is displayed on a blank screen: The signal frequency is out of range. Change the settings to a supported mode.

## Image is unstable, unfocused or swimming is apparent

- Signal cable should be completely attached to the computer.
- Disconnect the DisplayPort cable and touch SELECT key, and then adjust the OSD value using the - or + key.
- Use the OSD Image Adjust controls to focus and adjust the display by increasing or decreasing the [FINE] adjustment. When the display mode is changed, the OSD Image Adjust settings may need to be readjusted.
- Check the monitor and your display card with respect to compatibility and recommended signal timings.
- If your text is garbled, change the video mode to non-interlace and use 60 Hz refresh rate.

## Picture is not bright

- Make sure [ECO MODE] is turned off.
- Signal cable should be completely attached.
- LCD brightness degradation occurs due to long-term usage or extreme cold conditions.
- If the brightness fluctuates, make sure [DV MODE] is set to [OFF].

## LED on monitor is not lit (no blue or amber color can be seen)

- Power Switch should be in the ON position and power cord should be connected.

## Display image is not sized properly

- Use the OSD Image Adjust controls to increase or decrease the [H.SIZE] or select the [INPUT RESOLUTION].
- Make sure that a Major Supported Timings has been selected for the display card in the system being used. (Please consult the manual for the system or display card for supported resolution and changing the settings).

## No Video

- If no video is present on the screen, turn the ⏻ key off and on again.
- Make sure the computer is not in a power-saving mode (touch the keyboard or mouse).
- When using DisplayPort, some display cards do not output video signal under low resolution modes when the monitor is turned OFF/ON or disconnected/connected from the AC power cord.

## No Sound

- Check to see if speaker cable is properly connected.
- Check to see if mute is activated.
- Check the volume level in the OSD menu.
- If the input signal is DisplayPort or HDMI, make sure the [SOUND INPUT] in the OSD menu is set to [DP] or [HDMI].

## Brightness variations over time

- Change [DV MODE] to [OFF] and then adjust the [BRIGHTNESS].

**NOTE:** When [DV MODE] is set to [ON], the monitor automatically adjusts the [BRIGHTNESS] based on the video signal.



# Manufacturer's Recycling and Energy Information

NEC DISPLAY SOLUTIONS is strongly committed to environmental protection and sees recycling as one of the company's top priorities in trying to minimize the burden placed on the environment. We are engaged in developing environmentally-friendly products, and always strive to help define and comply with the latest independent standards from agencies such as ISO (International Organisation for Standardization) and TCO (Swedish Trades Union).

## Disposing of your old NEC product

The aim of recycling is to gain an environmental benefit by means of re-use, upgrading, reconditioning or reclamation of material. Dedicated recycling sites ensure that environmentally harmful components are properly handled and securely disposed. To ensure the best recycling of our products, **NEC DISPLAY SOLUTIONS offers a variety of recycling procedures** and gives advice on how to handle the product in an environmentally sensitive way, once it has reached the end of its life.

All required information concerning the disposal of the product and country-specific information on recycling facilities can be found on our following websites:

<https://www.nec-display-solutions.com/greencompany/> (in Europe),

<https://www.nec-display.com> (in Japan) or

<https://www.necdisplay.com> (in USA).

## Energy Saving

This monitor features an advanced energy saving capability. When a Display Power Management signal is sent to the monitor, the Energy Saving mode is activated. The monitor enters a single Energy Saving mode.

Mode	Power consumption	LED color
Maximum Operation	39 W	Blue
Normal Operation	12 W Default setting	Blue
Energy Saving Mode	0.30 W	Amber
Off Mode	0.27 W	Unlit

For additional information visit:

<https://www.necdisplay.com/> (in USA)

<https://www.nec-display-solutions.com/> (in Europe)

<https://www.nec-display.com/global/index.html> (Global)

For Energy Saving information:

For ErP requirement:

Setting: None.

Power consumption: 0.5 W or less.

Time for power management function: Approx. 1 min.

For ErP (Network standby) requirement:

Setting: None.

Power consumption: 0.5 W or less (with 1 port activating) / 3.0 W or less (with all ports activating).

Time for power management function: Approx. 1 min.

## WEEE Mark (European Directive 2012/19/EU and amendments)



### Disposing of your used product: In the European Union

EU-wide legislation as implemented in each Member State requires that used electrical and electronic products carrying the mark (left) must be disposed of separately from normal household waste. This includes monitors and electrical accessories, such as signal cables or power cords. When you dispose of such products, please follow the guidance of your local authority or ask the shop where you purchased the product, or if applicable, follow applicable legislation or agreement you may have. The mark on electrical and electronic products may only apply to the current European Union Member States.

### Outside the European Union

If you wish to dispose of used electrical and electronic products outside the European Union, please contact your local authority and ask for the correct method of disposal.