

EPOS

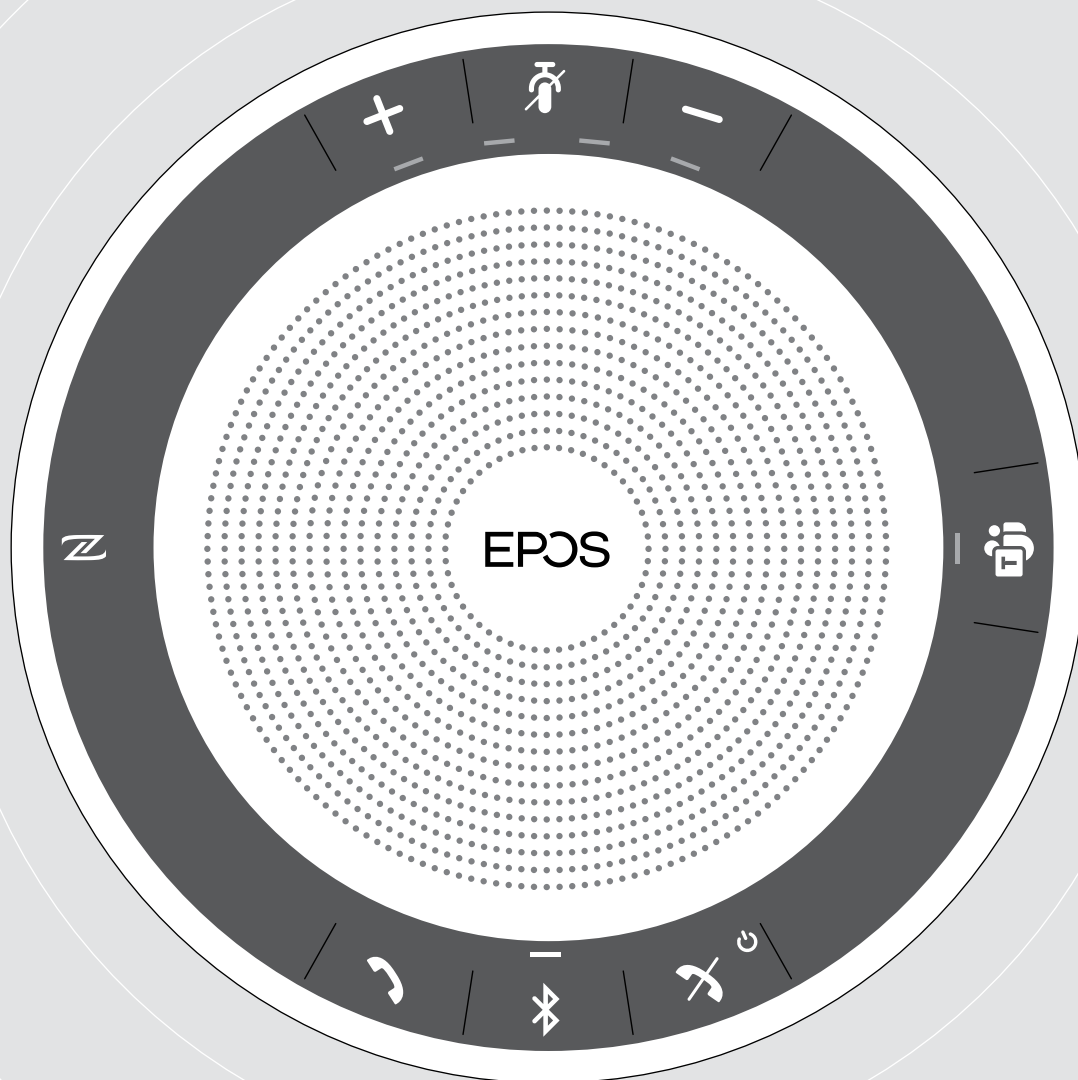

SP 30T





Bluetooth® Speakerphone for Microsoft® Teams

User Guide

Contents

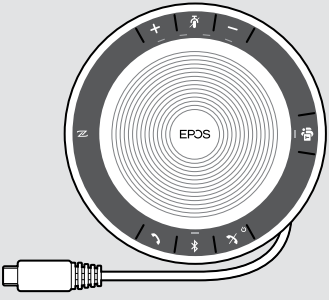
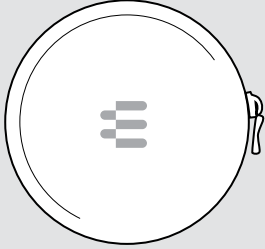
Package contents.....	2
Product overview.....	3
Overview of the Speakerphone.....	3
Overview of the BTD 800 USB dongle.....	5
Setting up the Speakerphone.....	6
A: Connecting via USB cable.....	6
Overview: Pairing the Speakerphone with wireless Bluetooth® devices.....	7
B: Pairing the Speakerphone and a mobile device via NFC™.....	8
C: Pairing the Speakerphone and a mobile device via Bluetooth®.....	9
D: Connecting the Bluetooth® dongle to a computer and pairing the Speakerphone.....	10
Installing EPOS software.....	11
Using the Speakerphone.....	12
Turning the Speakerphone on/off.....	12
Connecting Bluetooth® devices.....	12
Disconnecting Bluetooth® device(s).....	13
Clearing the speakerphone's pairing list.....	13
Clearing the dongle's pairing list.....	14
Bluetooth® transmission range.....	14
Adjusting the volume.....	15
Muting the microphone.....	15
Making calls using the Speakerphone.....	16
Making a call.....	16
Accepting/rejecting/ending a call.....	16
Redialing.....	17
Using the voice assistant/ voice dial.....	17
Managing multiple calls.....	18
Merging calls – Conference.....	20
Using the Speakerphone with Microsoft® Teams and Cortana.....	21
Invoking Microsoft® Teams and check notifications.....	21
Activating and using Microsoft® Cortana.....	21
Additional functions.....	22
Switching between Bluetooth® personal and shared mode.....	22
Waking up from standby.....	22
Listening to music using the Speakerphone – Audio playback.....	23
Retrieving battery status.....	23
Charging the Speakerphone.....	24
Enabling/disabling voice prompts.....	24
Maintaining and updating the products.....	25
Storing and carrying the Speakerphone.....	25
Cleaning the products.....	25
Replacing/removing the Speakerphone's rechargeable battery.....	26
Updating the firmware of the products.....	26
If a problem occurs.....	27
Restoring speakerphone's factory default settings.....	28
Specifications.....	29

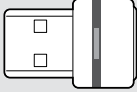
Package contents

	<p>SP 30T Bluetooth® speakerphone with built-in rechargeable battery</p>
	<p>Carry pouch</p>
	<p>USB-C™ to USB-A adapter</p>
	<p>BTD 800 USB Bluetooth® dongle</p>
	<p>Quick Guide Safety Guide Compliance sheet</p>



For safety instructions, consult the Safety Guide.



The free EPOS software EPOS Connect allows you to add value to your EPOS products.



A list of accessories can be found on the product page at www.eposaudio.com.

Product overview

Overview of the Speakerphone

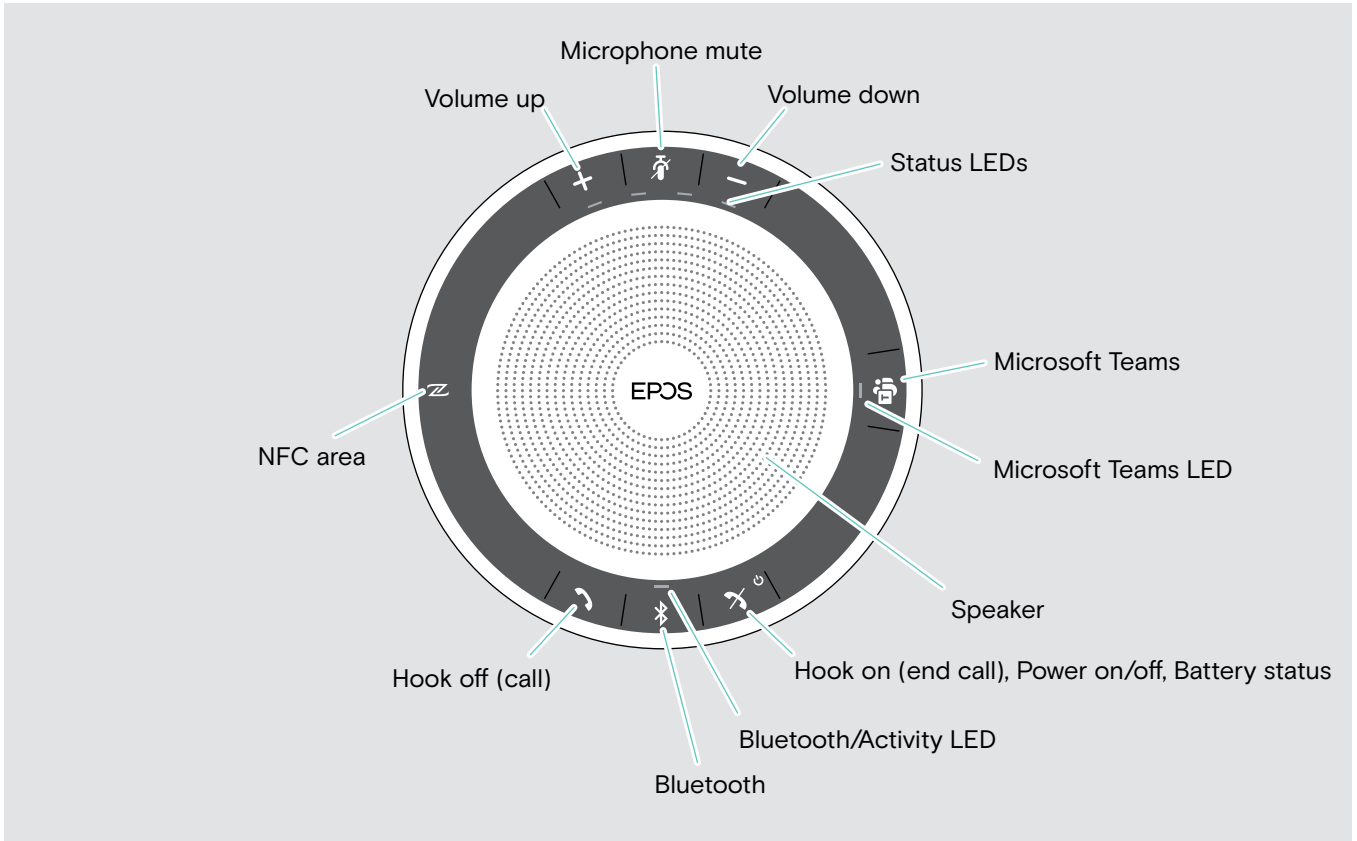



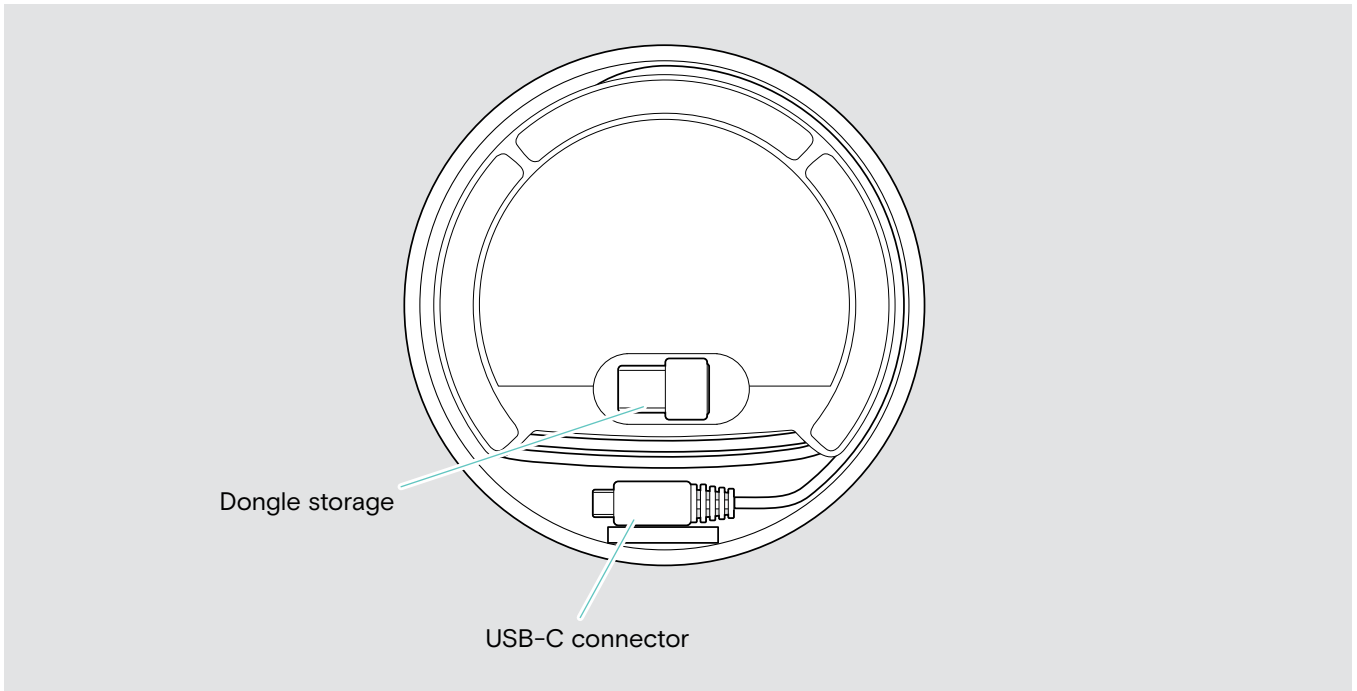























Overview of the bottom























LED overview

Bluetooth/Activity LED

	Meaning
	Speakerphone turned on
3x 	Speakerphone turning off
	Speakerphone turned off
   	Incoming call
	Active call
	Call on hold
   	Second call on hold
	Audio playback
   	Speakerphone in pairing mode
3x   2s   	Bluetooth device connected
   	Searching for paired Bluetooth devices













Status LEDs

	Meaning
   	Microphone muted
       	Battery status; eight step indication
   	Battery level low
   	Volume level; eight step indication



Microsoft Teams LED

	Meaning
   	<ul style="list-style-type: none"> Microsoft Teams connection mode Notification of voice message or meeting in progress or missed call Microsoft Teams failed connection (LED flashes 10 seconds)
	Microsoft Teams available
   	Cortana activating
3x 	Microsoft Teams not available



Overview of the BTD 800 USB dongle

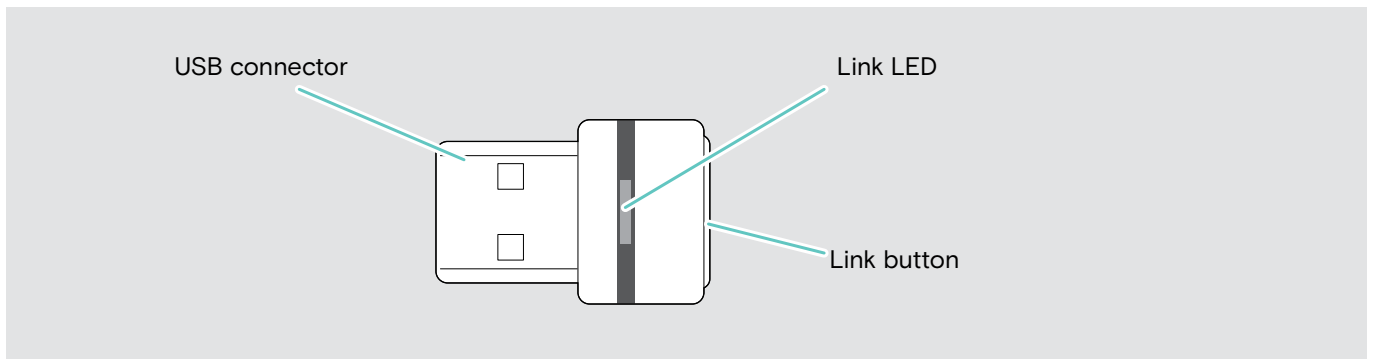

LED overview

	LED	Meaning
		Dongle in pairing mode: searching for Bluetooth devices to pair and connect
	3x	Pairing successful
	3x	Pairing failed
		Dongle tries to connect to a Bluetooth device
		Dongle and Bluetooth device connected
		Incoming call
		Outgoing/active call
		Audio playback
		Microphone of the connected Bluetooth device is muted

Setting up the Speakerphone

The speakerphone can be connected via:

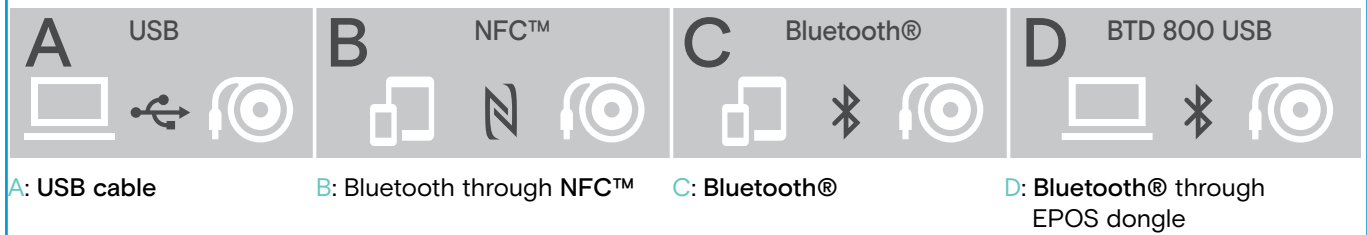

Automatic Microsoft Teams connect



Once the connection is successfully established to your USB or Bluetooth device, the speakerphone attempts to connect to Microsoft Teams. The LED pulses white until the speakerphone and Microsoft Teams are connected. Afterwards the speakerphone shows Microsoft Teams notifications (see page 21) and Cortana is ready to use (see page 21).

A: Connecting via USB cable

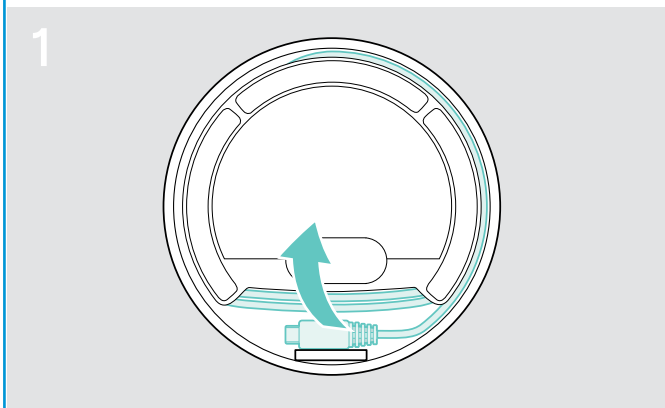

▶ Release the USB plug from the holder and unwind the cable.

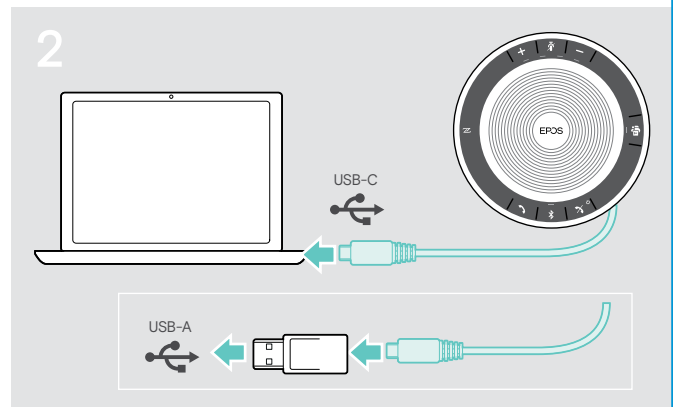

▶ Connect the USB connector directly to a USB-C port or to a USB-A port using the included adapter.

The speakerphone turns on automatically. The LED lights up white.

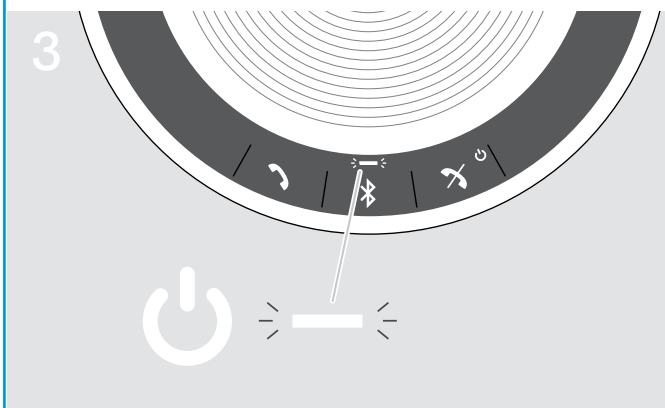

i The Speakerphone will be charged while connected (device dependent) - see page 24.

Overview: Pairing the Speakerphone with wireless Bluetooth® devices



CAUTION

Danger of malfunction!

The transmitted radio waves of mobile phones can impair the operation of sensitive and unprotected devices.

▶ Only make calls with the speakerphone in locations where wireless Bluetooth transmission is permitted.

The speakerphone complies with the Bluetooth 5.0 standard. In order to transmit data wirelessly, you have to pair your speakerphone with Bluetooth devices that support “hands free profile” (HFP), “headset profile” (HSP) or “advanced audio distribution profile” (A2DP).

The speakerphone can be paired to:

- a mobile device: via NFC™ (B, see page 8) or via Bluetooth (C, see page 9) or
- the BT-D 800 USB dongle: via Bluetooth (D, see page 10).

The speakerphone can be set to personal or shared mode (see page 22). The default setting is personal mode. In this mode, the list of paired devices is maintained so they reconnect automatically.

Default functionality (personal mode):

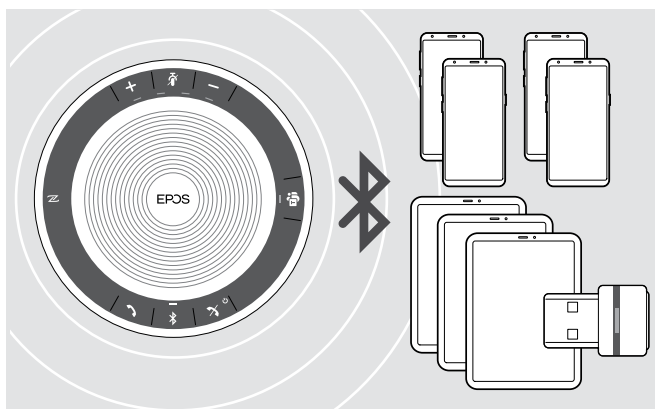

The speakerphone can save up to eight paired Bluetooth devices. If you pair the speakerphone with a ninth Bluetooth device, the saved connection profile of the least recently used device will be overwritten. If you want to re-establish a connection with this device, you have to pair the speakerphone again.

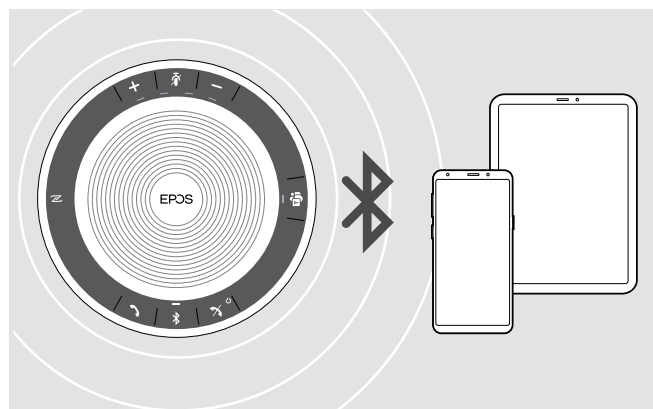

The Speakerphone can be wirelessly connected to two devices at the same time.

You can only connect another device by disconnecting one of the already connected devices.

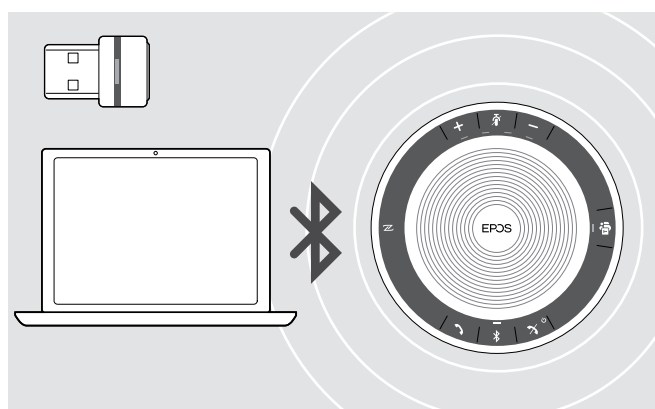

The speakerphone can be used wirelessly with a computer.

You can use:

- the computer's built in Bluetooth functionality or
- the BT-D 800 USB dongle.

B: Pairing the Speakerphone and a mobile device via NFC™



- ▶ Activate Bluetooth and NFC (Near Field Communication) on your mobile device (see instruction manual of your mobile device).

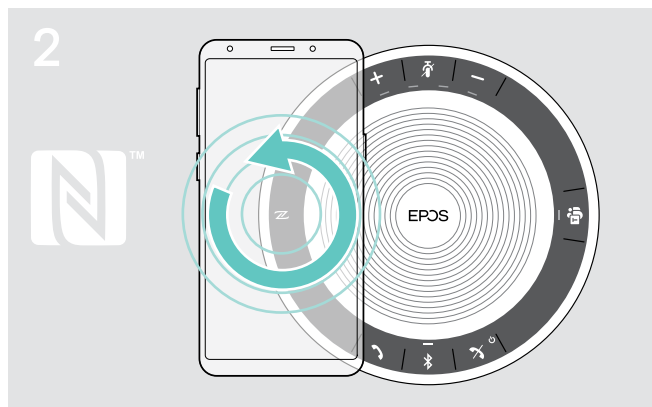

- ▶ Move the mobile device in small circles directly above the NFC area of the speakerphone. The speakerphone turns on automatically.

Once the speakerphone is paired with the mobile device, the LED shortly lights up blue and then turns white.

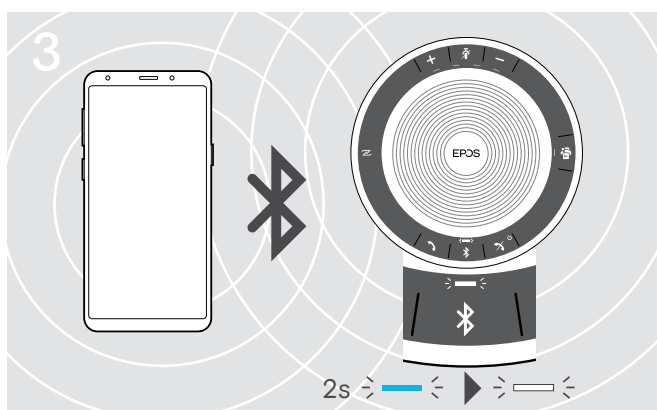

- i** If required: Confirm the speakerphone on your mobile devices.

C: Pairing the Speakerphone and a mobile device via Bluetooth®

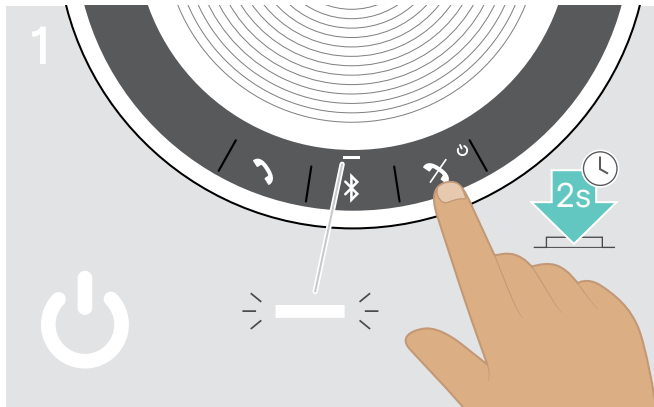

- ▶ Press and hold the Power on/off button to turn on the speakerphone. The LED lights up white.

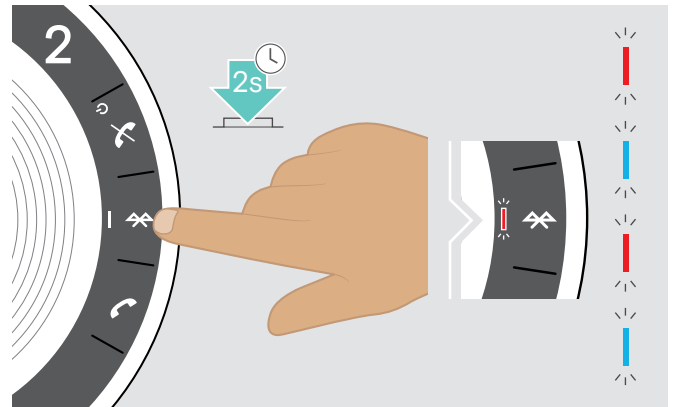

- ▶ Press and hold the Bluetooth button until the LED flashes blue and red. The speakerphone is in pairing mode.

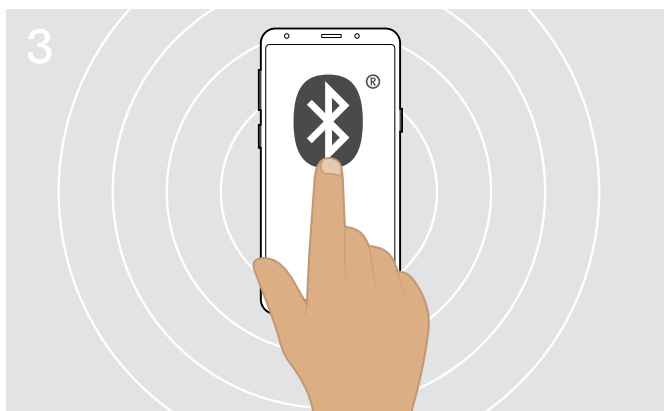

- ▶ Enable the Bluetooth visibility on your mobile device (see instruction manual of your mobile device).

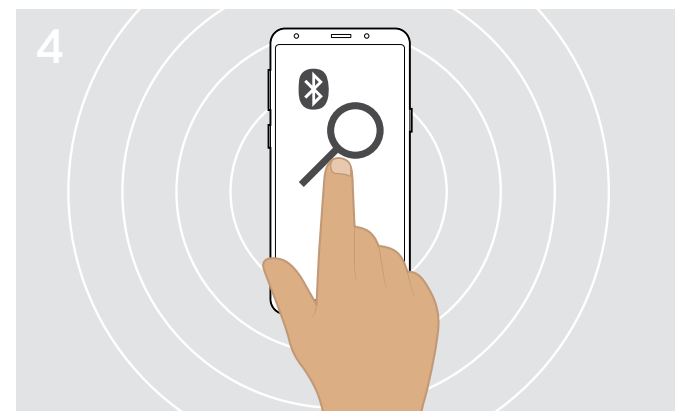

- ▶ Start a search for Bluetooth devices. All available devices in the proximity of the mobile device are displayed.



- ▶ Select "SP 30T"* to establish a Bluetooth connection to the speakerphone.
* You can change the default name "SP 30T" via [EPOS Connect](#).

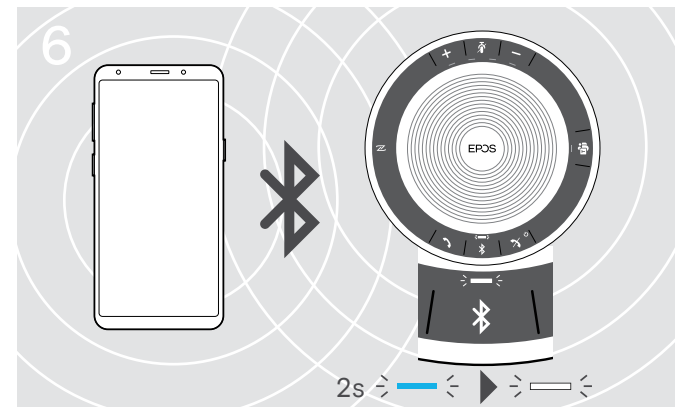

- ▶ Once the speakerphone is paired with the mobile device, the LED shortly lights up blue and then turns white.

D: Connecting the Bluetooth® dongle to a computer and pairing the Speakerphone

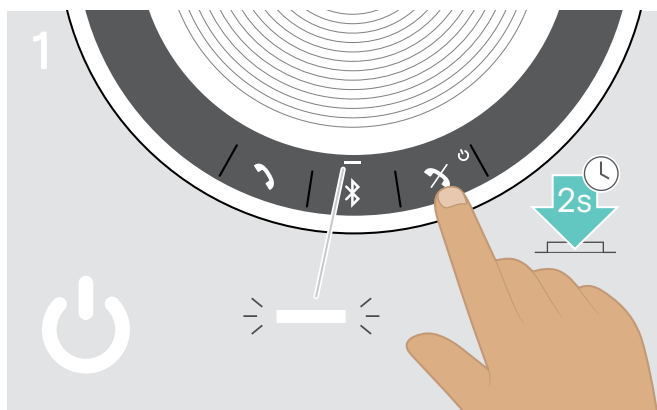

▶ Press and hold the Power on/off button to turn on the speakerphone. The LED lights up white.

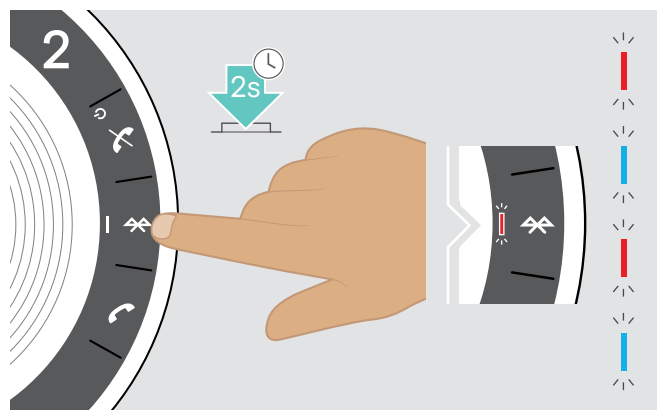

▶ Press and hold the Bluetooth button until the LED flashes blue and red. The speakerphone is in pairing mode.

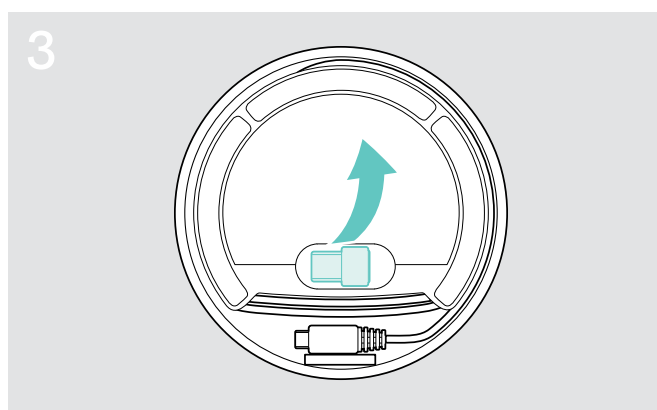

▶ Release the dongle from the storage.

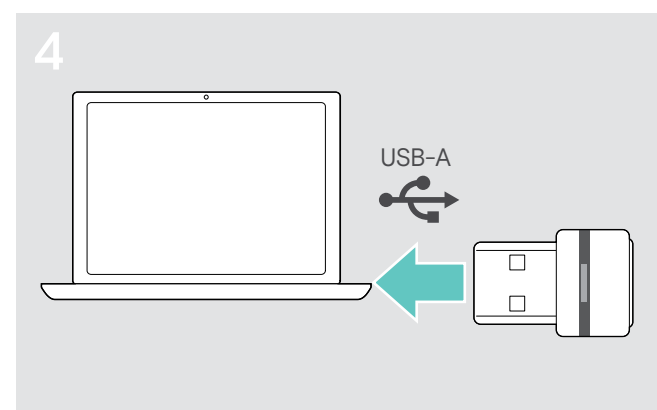

▶ Plug the dongle into the USB port of your computer.

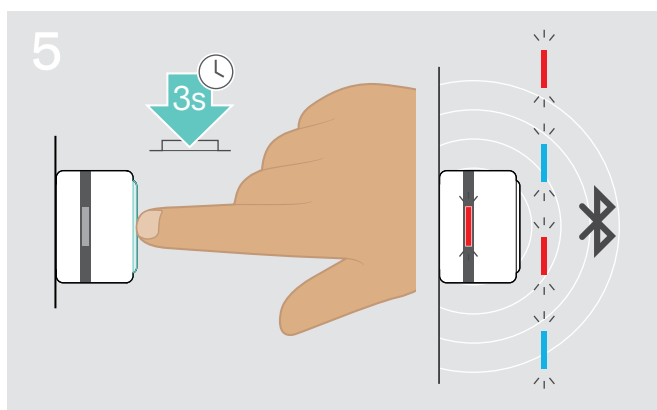

▶ Press and hold the dongle's button until the LED flashes blue and red. The dongle is in pairing mode.

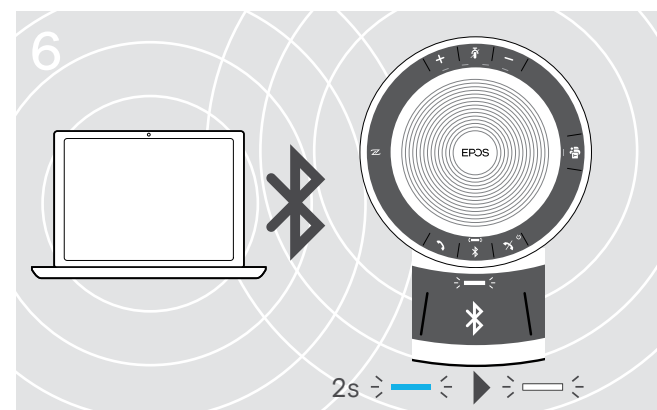

Once the speakerphone is paired with the dongle, the LED shortly lights up blue and then turns white.

Installing EPOS software

The free EPOS software allows you to add value to your EPOS products. It enables easy set-up, configuration and update of your speakerphone.

Examples of supported settings and configurations in [EPOS Connect](#):

- Bluetooth on/off,
- Device name
- Personal/shared mode,
- Manage pairing list
- Sounds and notifications including voice prompt language
- Factory reset

[EPOS Connect](#) offers further configurations and additional settings – see options in the software.



▷ Download the software from www.eposaudio.com/connect.

▷ Install the software.

You need administrator rights on your computer – if necessary, contact your IT department.

To make calls via the computer:

▷ Install a softphone (VoIP Software) or ask your admin for support.

Using the Speakerphone

Turning the Speakerphone on/off

Turning the Speakerphone on

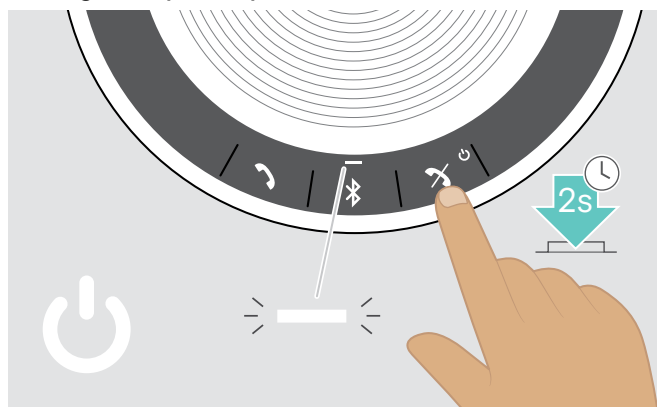

- ▶ Press and hold the Power on/off button. The LED lights up white.

Turning the Speakerphone off

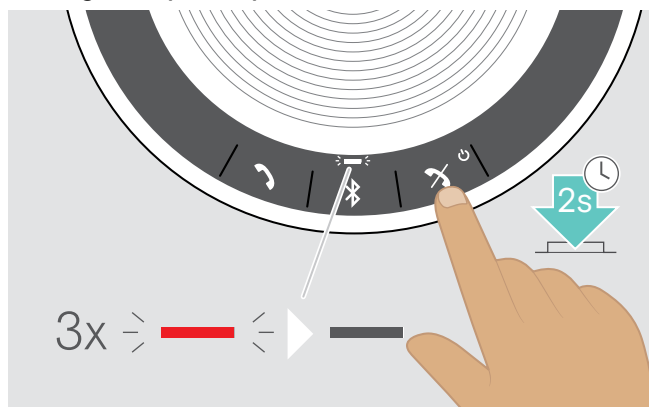

- ▶ Press and hold the Power on/off button. The LED flashes red 3 times and turns off. All volume settings are saved automatically when the speakerphone is turned off.

Connecting Bluetooth® devices

The speakerphone will by default attempt to connect to the two last connected Bluetooth devices. For further information concerning personal/shared mode functionality see page 22.

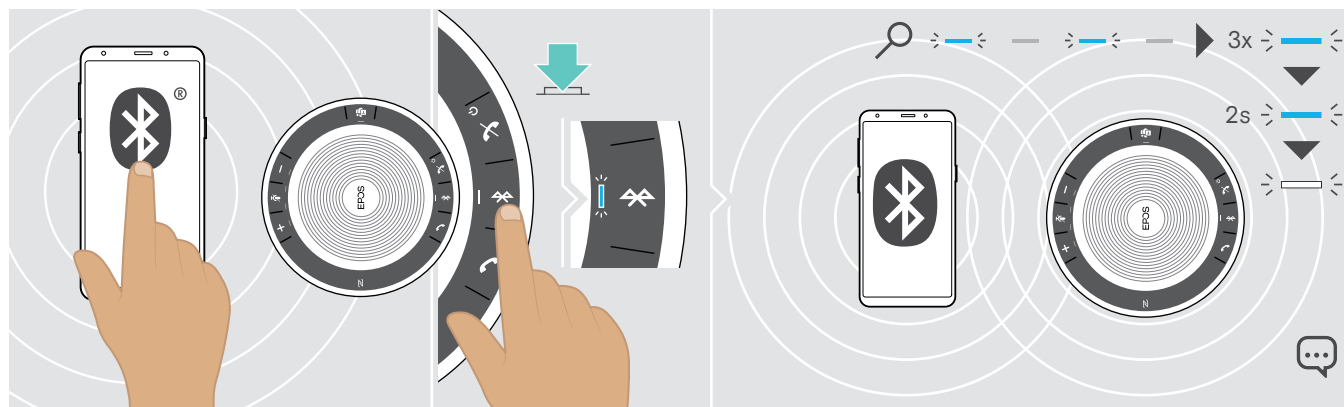

- ▶ Activate Bluetooth on the paired device(s).

If the Bluetooth LED does not flash blue (automatic search after switch-on):

- ▶ Press the Bluetooth button to connect manually.

The LED flashes blue while the speakerphone attempts to connect to previously paired Bluetooth device(s).

Once the connection is successfully established, the LED shortly lights up blue and then turns white.



Only two out of the maximum eight paired Bluetooth devices can be simultaneously connected to the speakerphone.

The search for paired devices will timeout if no devices are found. After this, connections must be established manually on the paired Bluetooth device or by pressing the Bluetooth button on the Speakerphone

Disconnecting Bluetooth® device(s)

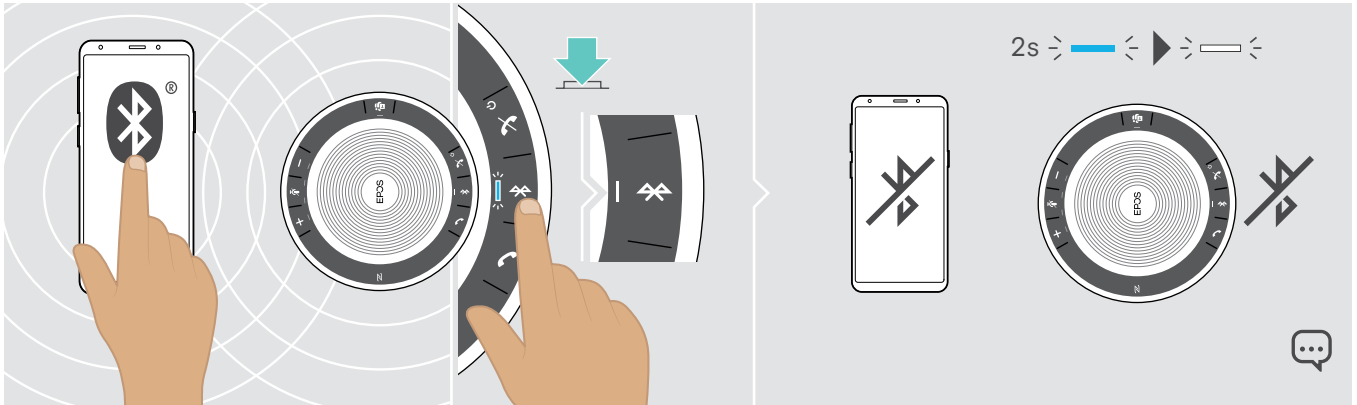

- ▶ Press the Bluetooth button.
The LED shortly lights up blue and then turns white.
- OR
Deactivate Bluetooth on the connected device.

- To re-connect paired Bluetooth devices:
- ▶ Press the button again.

Clearing the speakerphone's pairing list

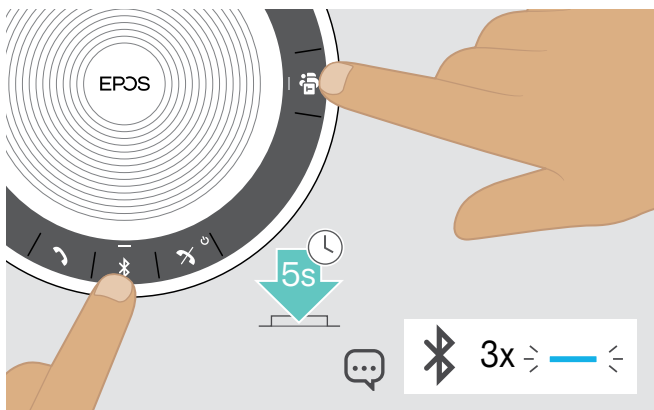

- ▶ Press and hold the buttons Bluetooth and Microsoft Teams until you hear a voice prompt.
The LED flashes blue three times to indicate that pairing list is cleared.

Clearing the dongle's pairing list

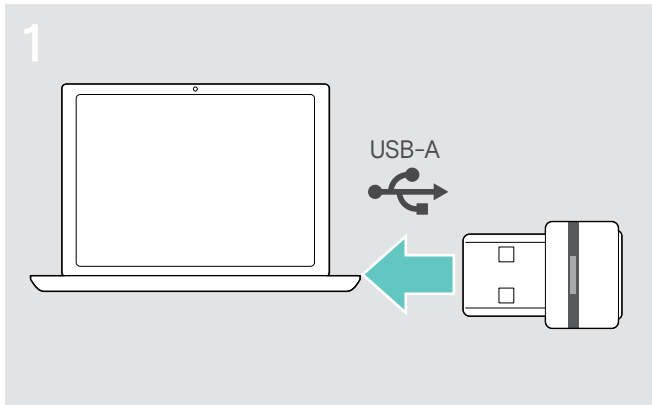

▶ Plug the dongle into the USB port of your computer.

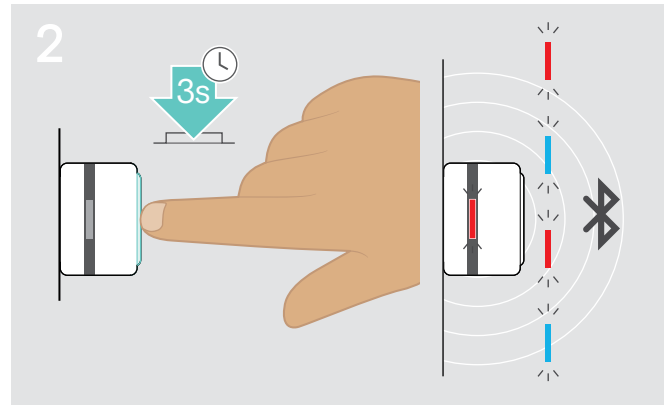

▶ Press and hold the button until the LED flashes blue and red.

▶ Double tap the button. The LED flashes purple three times to indicate that pairing list is cleared.

The dongle automatically enters pairing mode.

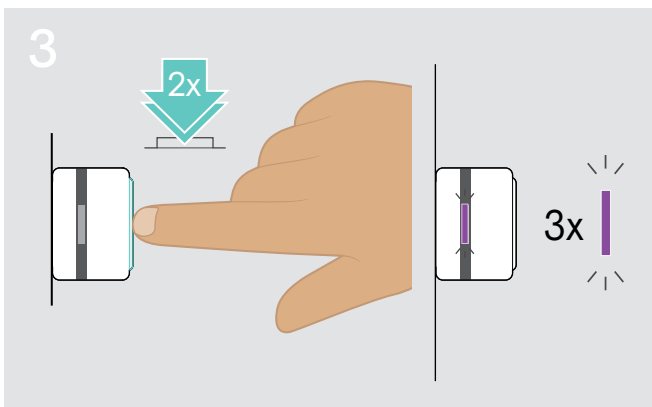

Bluetooth® transmission range

Calling and audio playback is only possible in the Bluetooth transmission range of the devices. The transmission range largely depends on environmental conditions such as wall thickness, wall composition etc. With a free line of sight, the transmission range of most mobile phones and Bluetooth devices is up to 25 meters.

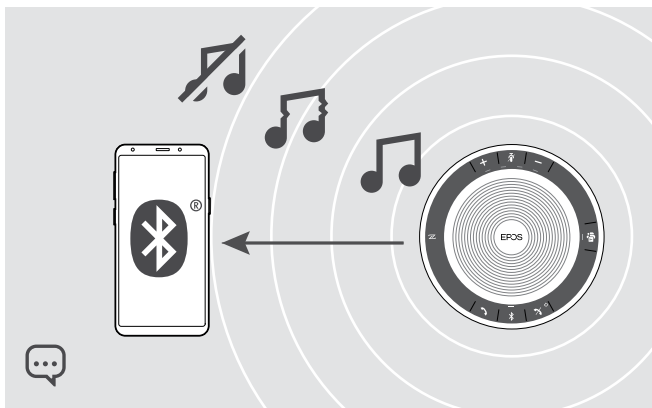

If you leave the Bluetooth transmission range, the audio quality deteriorates first and later connected devices will be disconnected.

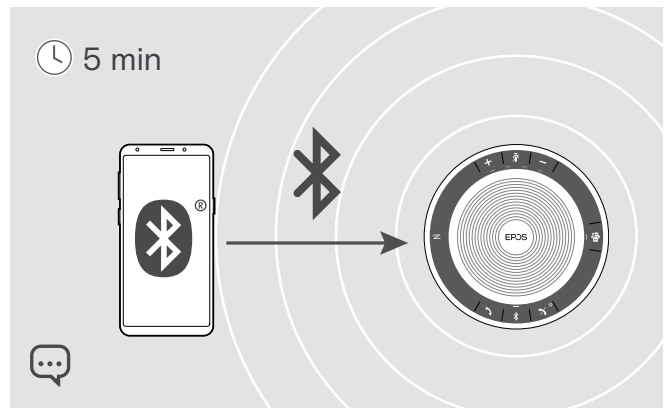

If you re-enter the Bluetooth transmission range **within short period of time**, the speakerphone will attempt to restore the connection(s) – in personal mode only.

If you spend **a longer period of time** outside the Bluetooth transmission range:

▶ Press the Bluetooth button to connect manually.

Adjusting the volume

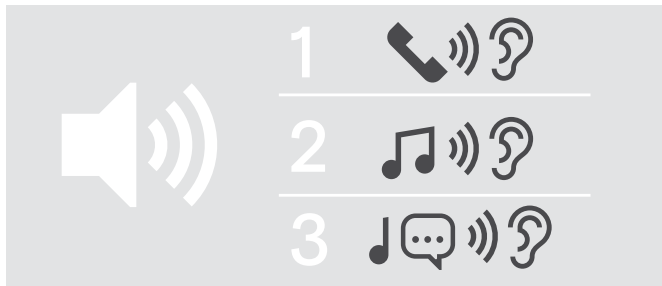

You can adjust three independent volume settings for the speakerphone:

1. Call volume: during an active call
2. Audio volume: during audio streaming
3. Volume for ring tone, tones and voice prompts: in idle mode - no active call or audio streaming

Increasing the volume

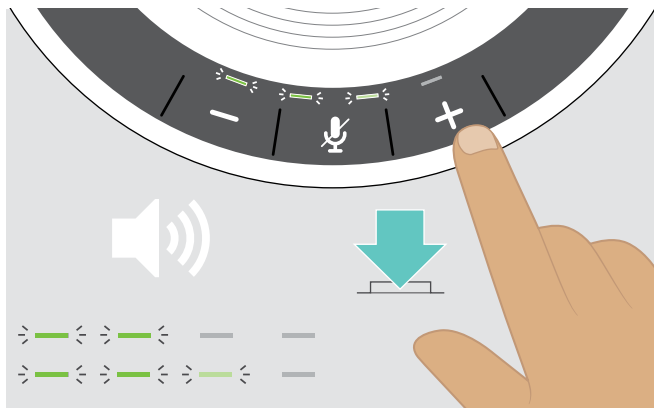

▶ Press the button +
LEDs and volume will be increased or reduced by half step with each button press.

Decreasing the volume

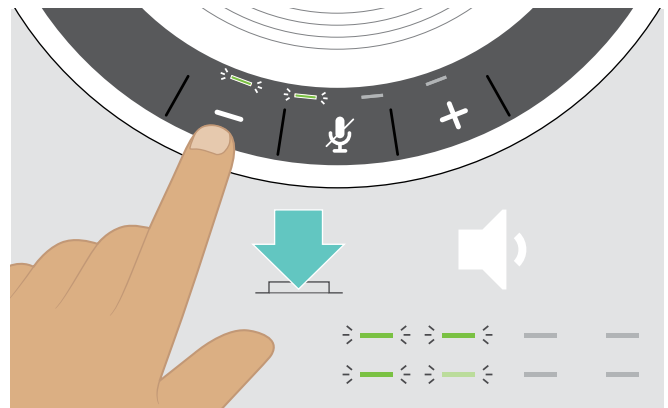

▶ Press the button -

Muting the microphone

Muting the microphone

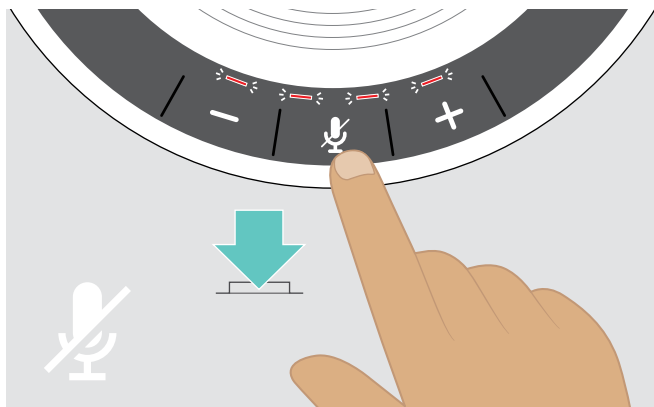

▶ Press the Microphone mute button.
The LEDs light up red.

Unmuting the microphone

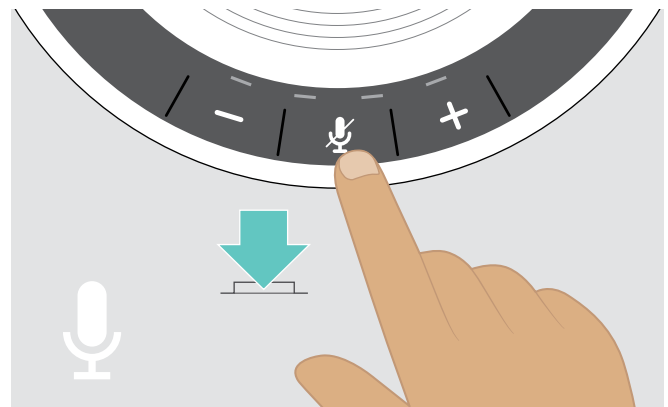

▶ Press the button again.
The LEDs turn off.

Making calls using the Speakerphone

Making a call

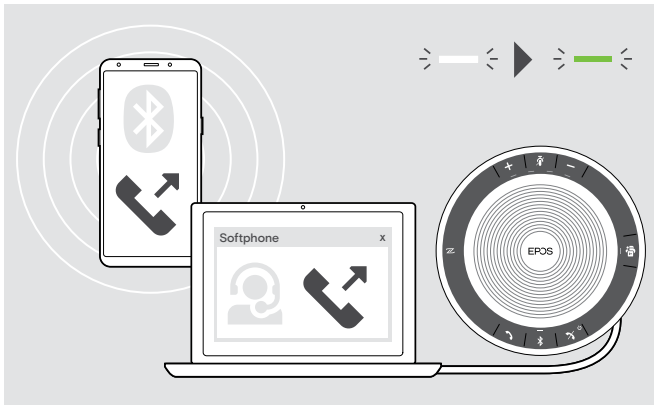

- ▶ Initiate the call on your connected device. The LED lights up green.

If your call is not automatically transferred to the speakerphone:

- ▶ Press the speakerphone's hook off button , or use call transfer functionality on the mobile device.

Accepting/rejecting/ending a call

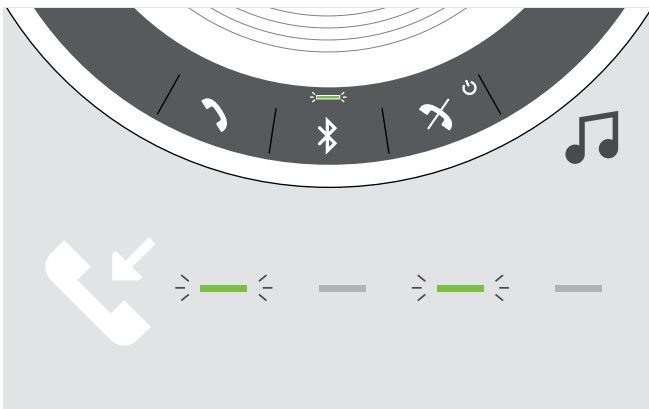





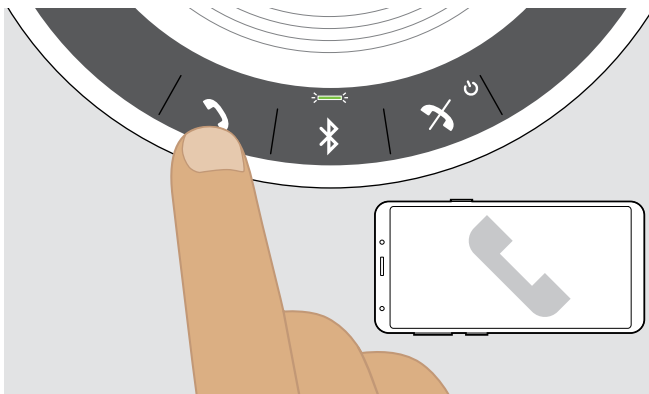

When you receive a call:

You hear a ring tone and the LED flashes green.







Accept/hold a call

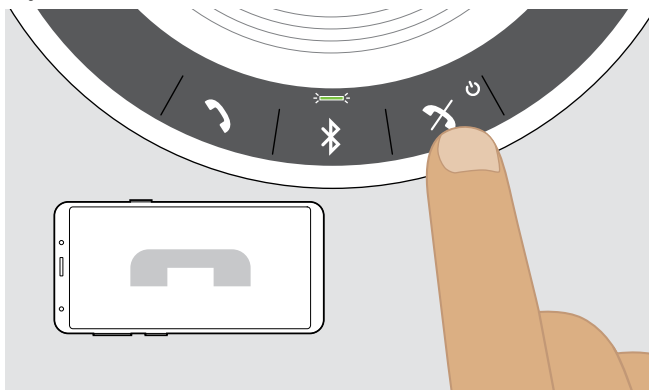

	 Accepts a call
LED	
	 Puts an active call on hold (pause)
LED	

Reject/end a call



	 Rejects a call
LED	
	 Ends a call
LED	

Redialing

		Redials the last number
	LED	➤ — — — ➤ ➤ — — —
		Cancels redialing
	LED	➤ — — — ➤ ➤ — — —

Using the voice assistant/ voice dial

Voice assistant and voice dialing will only be supported for device(s) connected via Bluetooth. Available functionality depends on the connected device. For Microsoft Cortana: see page 21.

		Activates voice assistant/ voice dial
	LED	➤ — — — ➤ ➤ — — —
		Cancels voice assistant/ voice dial
	LED	➤ — — — ➤ ➤ — — —

i The last connected Bluetooth device will be used for voice assistant or voice dial.

Managing multiple calls

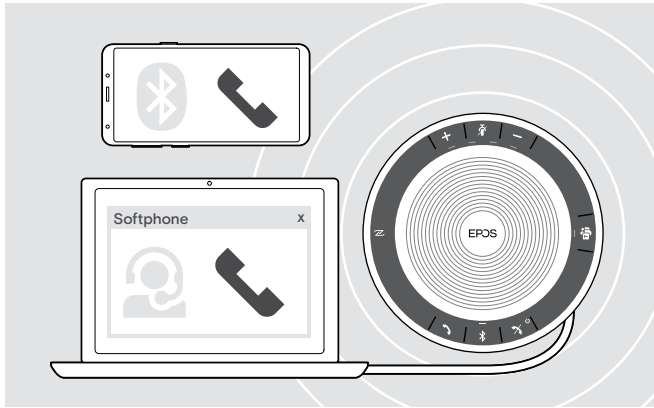

You can use the Speakerphone with up to three connected devices, one connected via USB and two via Bluetooth.

Two calls can be managed simultaneously.

If you receive a call during an active call, a knock on tone will be played.

Accept second call

Active call 2nd incoming call

Accepts the incoming call and puts the active call on hold

LED >|< — >|< — ▶ >|< >|< >|< >|<

Reject second call

Active call 2nd incoming call

Rejects the incoming call and continues the active call

LED >|< — >|< — ▶ >|<

Toggle between calls

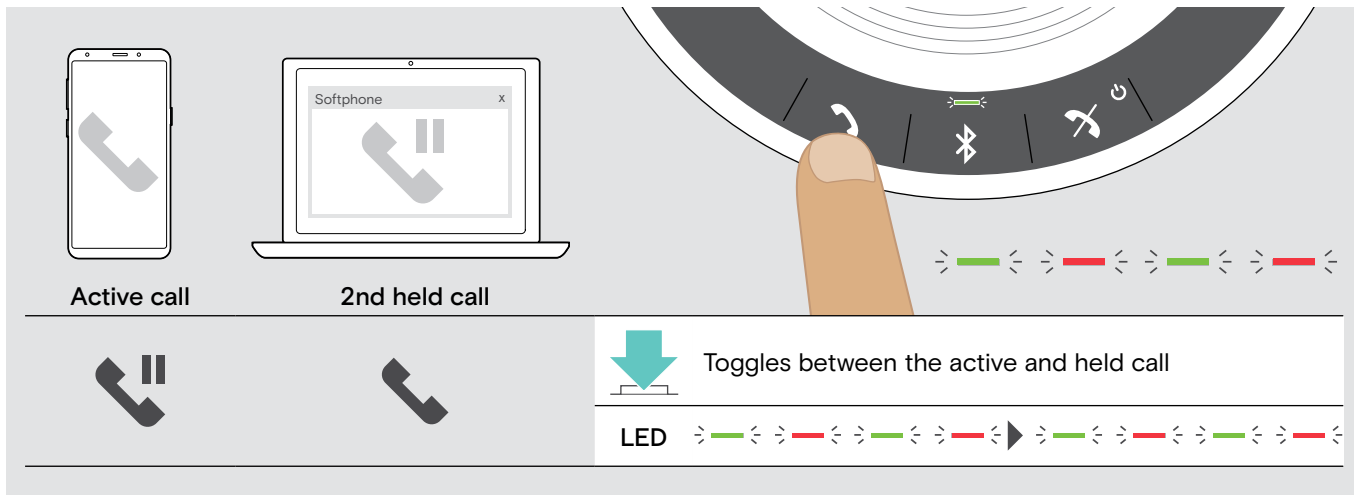

End call

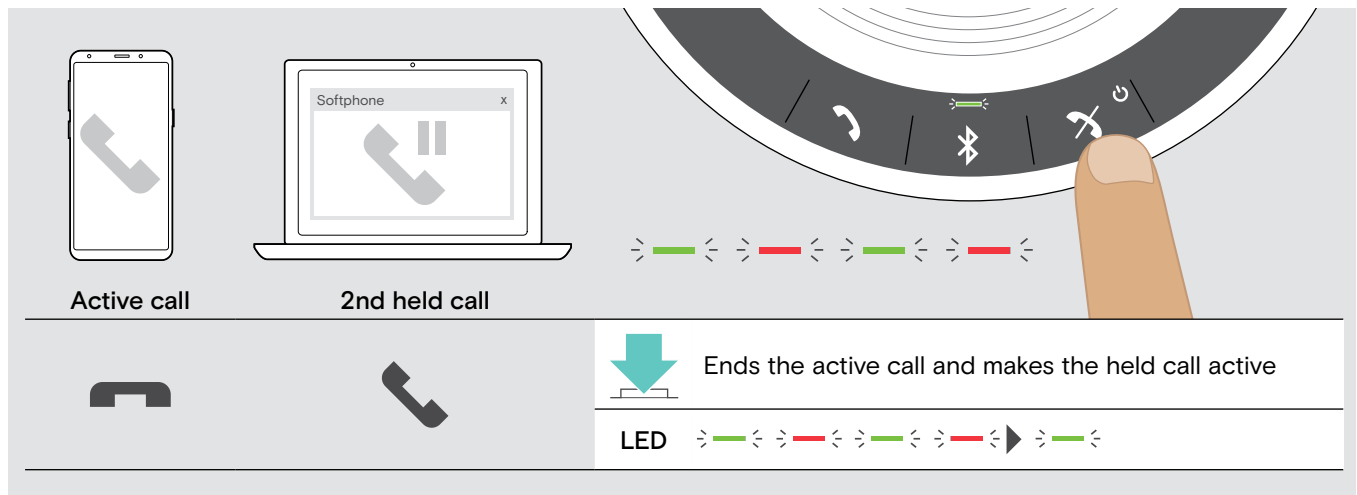

Merging calls – Conference

Two calls – one via USB, the other via Bluetooth – can be merged in a conference.

Merge/unmerge calls

The diagram illustrates the process of merging and unmerging calls using a speakerphone control panel. It shows a smartphone with an active call and a laptop with a 2nd held call. A finger is shown pressing the merge button (two call icons) on the speakerphone's touchpad. Below this, two rows of call status icons and LED indicator patterns are shown, each with a 2-second timer icon.

Active call	2nd held call	
		Merges the active call and the held call LED
		Unmerges the calls; puts the previously held call on hold again LED

End merged calls

The diagram illustrates the action to end merged calls. It shows a smartphone with Call 1 and a laptop with Merged call 2. A finger is shown pressing the end call button (phone icon with a slash) on the speakerphone's touchpad. Below this, a row of call status icons and LED indicator patterns is shown, with a 2-second timer icon.

Call 1	Merged call 2	
		Ends all calls LED

Using the Speakerphone with Microsoft® Teams and Cortana

Once the connection is successfully established to your USB or Bluetooth device, the speakerphone attempts to connect to Microsoft Teams. The LED flashes white until the speakerphone and Microsoft Teams are connected. Afterwards the speakerphone shows Microsoft Teams notifications and Cortana is ready to use.

Invoking Microsoft® Teams and check notifications

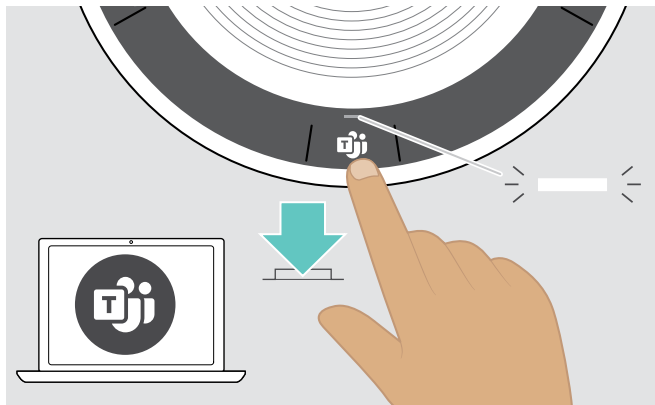

If the LED does not light up white:

- ▶ Press the Microsoft Teams button. The LED flashes white while trying to establish a connection to Microsoft Teams.



Microsoft Teams opens up. The LED lights up white.



The LED flashes white to show ▶ ◀ — ▶ ◀ — :

- a new voice message
- a meeting in progress
- a missed call

Activating and using Microsoft® Cortana

You can activate and use Cortana – Microsoft’s Personal Digital Assistant using Voice command technology – with the speakerphone.

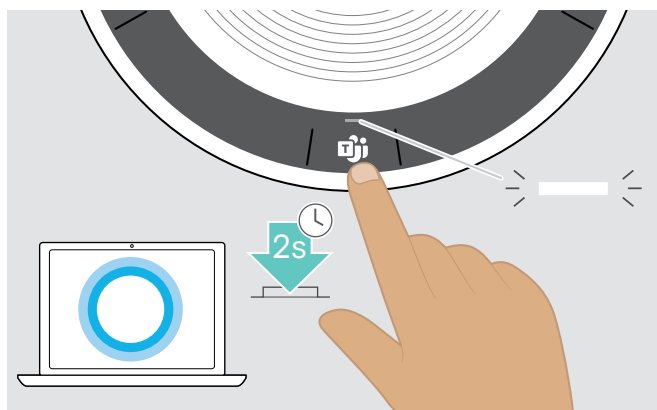

- ▶ Press the Microsoft Teams button. The LED flashes fast white while activating Cortana.

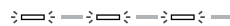

The LED lights up white.



Additional functions

Switching between Bluetooth® personal and shared mode

If the speakerphone is used as a **personal device** it will automatically attempt to connect to the last eight paired devices. In this setup the **Personal Mode** (default) should be used.

If the speakerphone is used as a **shared device** automatic connection to previously paired devices may not be desired. In this setup the **Shared Mode** should be used. In this mode pairing must be performed every time when connecting a device via Bluetooth.

Activating Personal mode

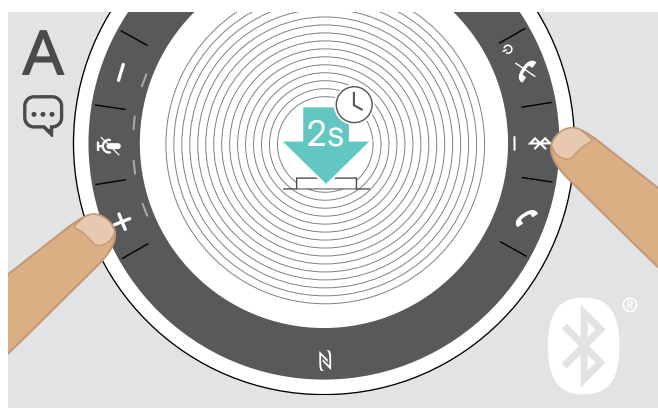

- ▶ Press the Bluetooth and + button.
A voice prompt is announced.

Activating Shared mode

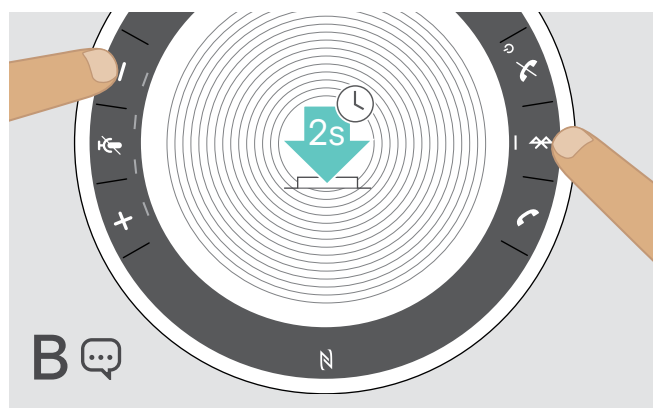

- ▶ Press the Bluetooth and - button.
A voice prompt is announced.

After change of mode, the pairing list is cleared and you have to pair devices again (see page 7).

Waking up from standby

The speakerphone enters standby mode automatically after some time to save energy – depends on connection status, activity etc.



While in standby the activity LED is dimmed and all other LEDs are off.



- ▶ Press any button or plug in USB to end the standby mode.



After a while in standby mode, the speakerphone turns off, if there are no active connections and not connected to a power source.

Listening to music using the Speakerphone – Audio playback

You can listen to audio playback via USB or Bluetooth connected device.

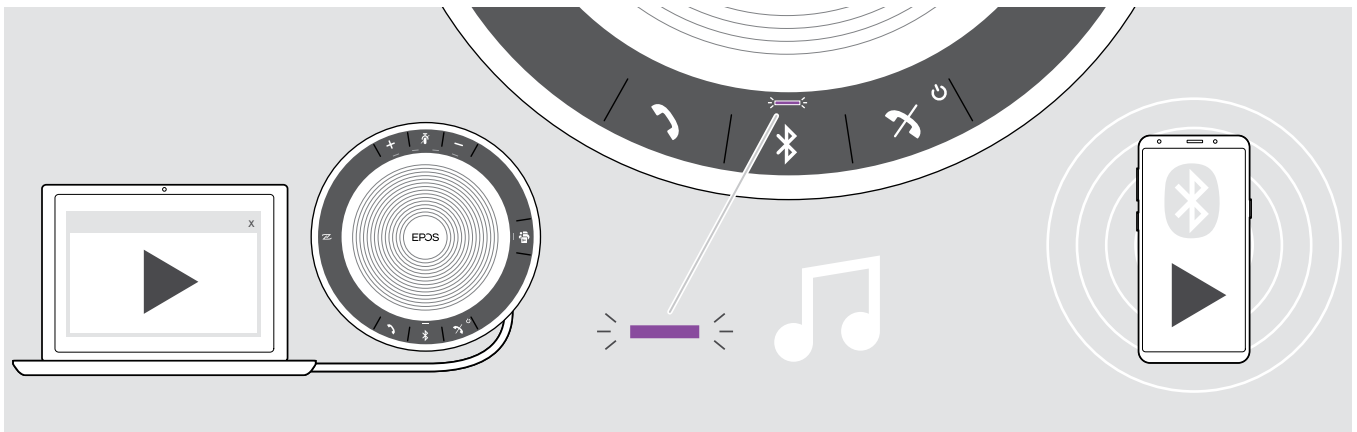

i If you receive and accept a call, audio playback is paused and restarts after the call – if supported by the connected device.

Retrieving battery status



▶ Press the Battery status button. The LEDs light up shortly.

LED	Battery status
	100%
	between 75% and 100%
	75%
	between 50% and 75%
	50%
	between 25% and 50%
	25%
	between 10% and 25%
	critically low battery: LED flashes red

▶ Recharge speakerphone (see page 24).

Charging the Speakerphone

When the battery charge level drops below 10%, the LED flashes red. When the battery is empty, the speakerphone turns off automatically.

If you do not use the speakerphone for extended periods of time it is recommended to charge it every 3 months.

You can charge the speakerphone regardless of the power state (on or off).

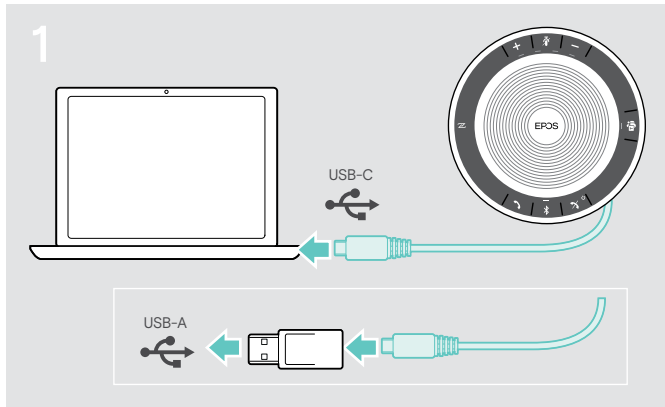

- ▶ Connect the USB connector to a USB-C or USB-A socket of your computer, or to a USB power source. The speakerphone turns on.

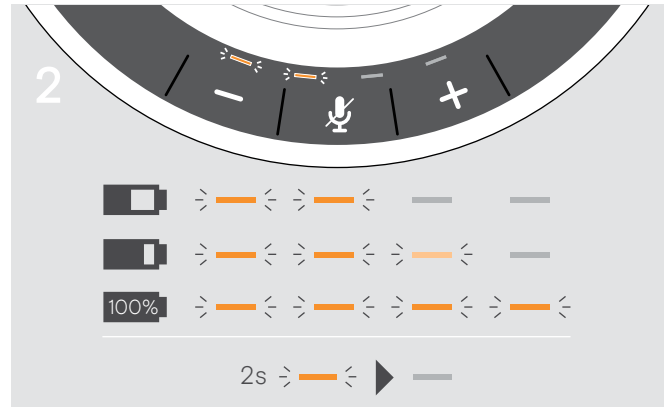

- The battery is being charged. The LEDs shortly light up and show the battery charge level.

Enabling/disabling voice prompts

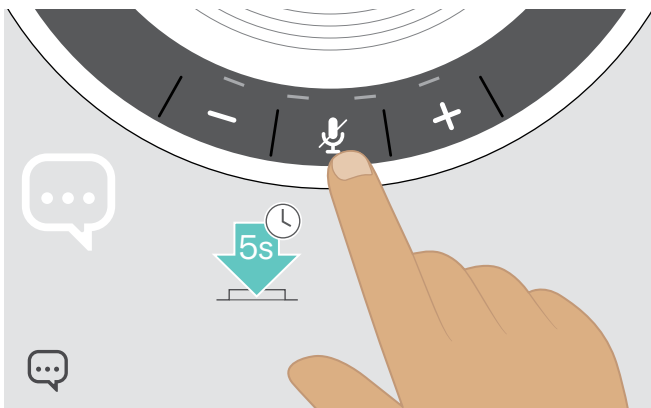

In idle mode (no active call or music reproduction):

- ▶ Press and hold the mute button until the speakerphone announces a voice prompt for on or off.

If the voice prompts are deactivated you hear tones instead.

Maintaining and updating the products

Storing and carrying the Speakerphone

Store the speakerphone in a clean and dry environment. When not in use, store the product in the carry pouch. This will help to avoid scratches and keep the product in good condition.

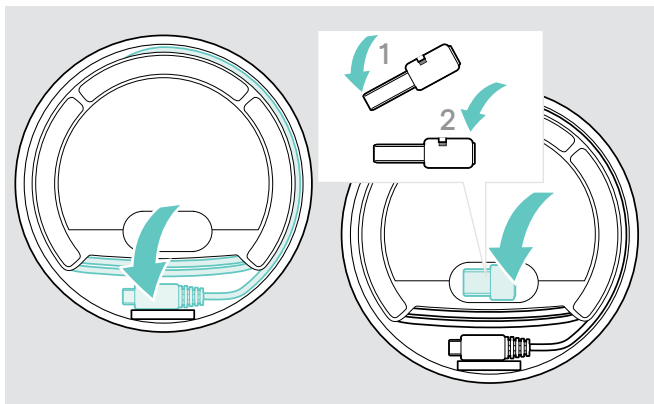

- ▷ Wind up the USB cable.
- ▷ Place the dongle in the storage slot.

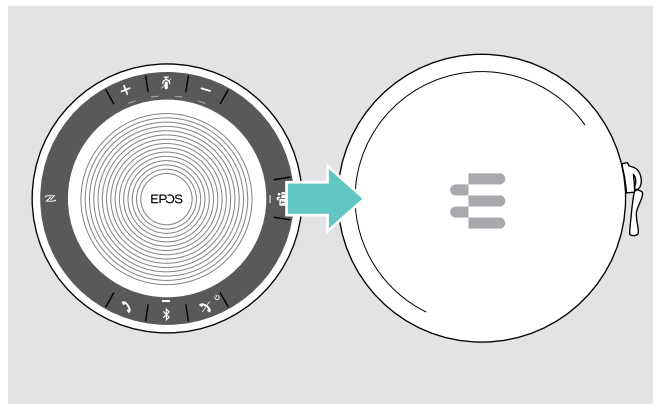

- ▷ Put the speakerphone in the Carry pouch.

Cleaning the products

CAUTION

Liquids can damage the electronics of the product!

Liquids entering the housing of the device can cause a short circuit and damage the electronics.

- ▷ Keep all liquids far away from the product.
- ▷ Do not use any cleansing agents or solvents.

- ▷ Only use a dry cloth to clean the product.

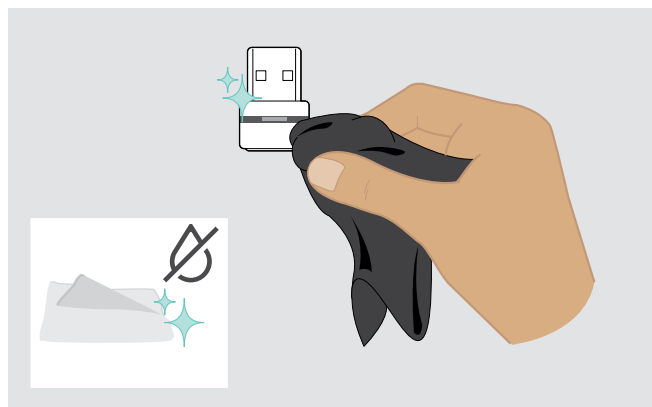

Replacing/removing the Speakerphone's rechargeable battery

CAUTION

Danger of damage to the product!

During the warranty period, the rechargeable battery must only be replaced by an authorized EPOS service center, otherwise the warranty will be null and void.

- ▶ Contact your EPOS service center if the rechargeable battery needs to be replaced. To find a EPOS service partner in your country, visit www.eposaudio.com.

Outside the warranty period, the rechargeable battery may be replaced or removed by any qualified service center or qualified technician of your IT or Service department. Instructions for qualified technicians on how to replace or remove the battery are available from the EPOS service partner.

Updating the firmware of the products

You can update the firmware of your speakerphone and dongle by using the free [EPOS Connect](#) software.

- ▶ Download the software from www.eposaudio.com/connect.
- ▶ Install the software.
To install the software, you need administrator rights on your computer. If necessary, contact your IT department.

Updating the firmware of the speakerphone

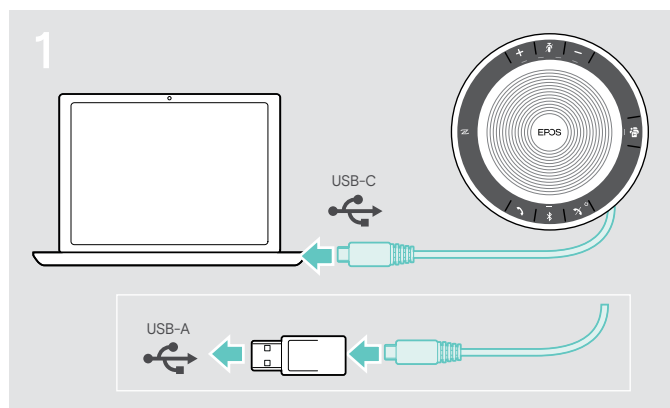

- ▶ Connect the USB connector directly to a USB-C port or to a USB-A port using the included adapter. The speakerphone turns on automatically.



- ▶ Start [EPOS Connect](#). [EPOS Connect](#) checks if the installed firmware is the latest version available on the EPOS server. If required, upgrade to the latest version.

Updating the firmware of the Bluetooth dongle BTD 800 USB

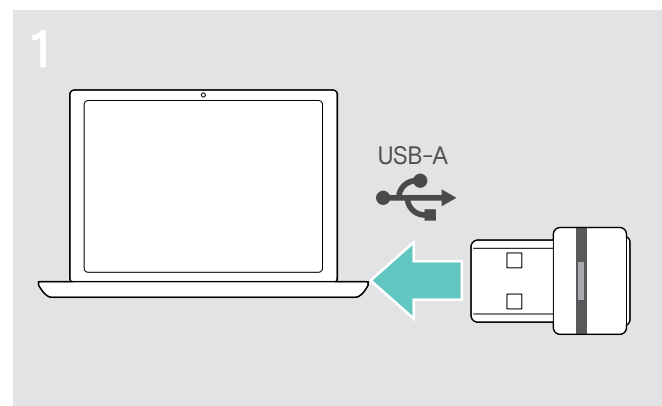

- ▶ Plug the Bluetooth USB dongle into the USB port of your computer.

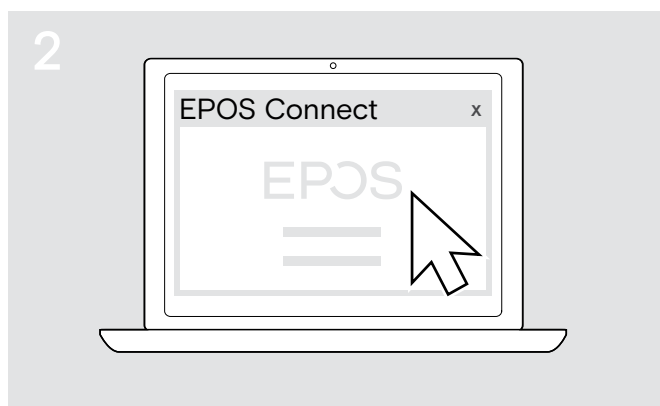

- ▶ Start [EPOS Connect](#). [EPOS Connect](#) checks if the installed firmware is the latest version available on the EPOS server. If required, upgrade to the latest version.

If a problem occurs ...

Problem	Possible cause	Solution	Page
Speakerphone cannot be turned on	Battery is empty	▷ Charge the battery.	24
No audio signal	USB connector not inserted correctly in the computer or adapter	▷ Plug in again.	6
	Speakerphone is not paired with the mobile device or dongle	▷ Check if the speakerphone is paired. If necessary, pair the speakerphone again.	7
	Volume is adjusted too low	▷ Increase the volume.	14
	Speakerphone is turned off	▷ Turn the speakerphone on.	12
	Computer connection: Speakerphone not selected as audio device	▷ Change the audio settings of your computer.	-
Bad audio quality	Bluetooth transmission range is exceeded	▷ Reduce the distance between speakerphone the connected Bluetooth device.	14
Connection to Microsoft Teams failed	Microsoft Teams not installed on connected computer or old version	▷ Install Microsoft Teams or update to latest version.	-
Speakerphone cannot be paired/connected	Pairing does not work	▷ Check if your Bluetooth device supports the Handsfree or Headset profile.	-
	Speakerphone's pairing list was cleared but it is still in the list of paired devices of the Bluetooth device	▷ Remove the speakerphone from the list of paired devices in your Bluetooth device. ▷ Pair devices again.	-
	Distance too high while pairing	▷ Reduce the distance between speakerphone the Bluetooth device.	-
	Bluetooth not enabled	▷ Make sure Bluetooth is enabled on the speakerphone and the device connecting to.	-
Activity LED is dimmed and all other LEDs off	Speakerphone in standby mode	▷ Press any button or plug in USB to end the standby mode.	22
No voice prompts announced (tones only)	Voice prompts are disabled	▷ Enable the voice prompts.	16
Speakerphone does not react to any button press	Operation of the speakerphone is faulty	▷ Press and hold the Power on/off button for 10 seconds to reboot the speakerphone.	-
		▷ Restore factory default settings.	28
No Bluetooth connection via dongle BTD 800 USB	Dongle not inserted correctly in the computer	▷ Insert the dongle again.	10
	Dongle and speakerphone not connected	▷ Pair the dongle and your speakerphone.	10
Speakerphone/dongle does not accept new devices (Pairing)	Pairing list disturbed	▷ Clear the speakerphone's list of previously paired devices.	13
		▷ Clear the dongle's list of previously paired devices.	14

If a problem occurs that is not listed in the above table or if the problem cannot be solved with the proposed solutions, please contact your local EPOS partner for assistance.

To find a EPOS partner in your country, search at www.eposaudio.com.

Restoring speakerphone's factory default settings

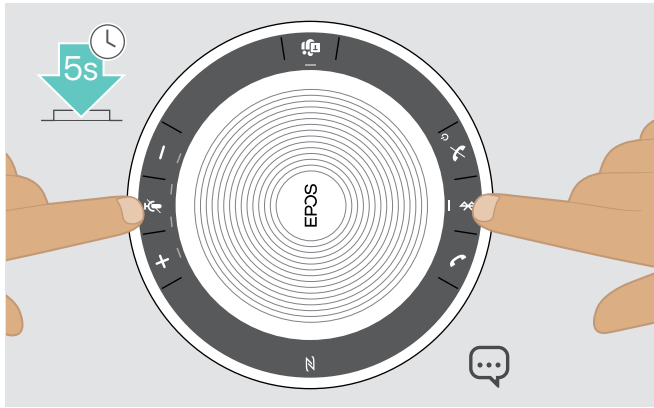

- ▶ Press and hold the mute button and Bluetooth button until the device restarts. All settings and the pairing list will be cleared.

Specifications

SP 30T Speakerphone

Dimensions (Ø x H)	120 x 37 mm / 4.72 x 1.47 in
Weight	approx. 314 g / 11.08 oz
Talk time	up to 18 hours
Charging time	approx. 3 h 20 min
Max. charging voltage	5 V / max. current 500 mA (computer) / 1300 mA (fast-charger)
Rechargeable battery (built-in)	Lithium Polymer; 3.7 V / 1110 mAh
Speaker type	dynamic, neodymium magnet
Speaker frequency response	Communication mode (USB / Bluetooth) 150 – 7,500 Hz Music mode (USB / Bluetooth) 100 – 20,000 Hz
Microphone type	Digital MEMS
Microphone frequency response	150 – 7,500 Hz (USB / Bluetooth)
Connector	USB-C

BTD 800 USB Bluetooth® dongle

Dimensions (W x H x D)	22 x 16 x 6 mm / 0.87 x 0.63 x 0.24 in
Weight	2 g / 0.07 oz / 0.004 lbs

Bluetooth®

Bluetooth	Speakerphone: version 5.0/ class 1 Dongle: version 4.2/ class 1
Range	up to 25 m (device-dependent)
Transmission frequency	2402 – 2480 MHz
Profiles	<ul style="list-style-type: none"> • HSP Headset Profile (version 1.2) • HFP Handsfree Profile (version 1.7) • A2DP Advanced Audio Distribution Profile (version 1.3) • AVRCP Audio Video Remote Control Profile (version 1.6) • DI Device ID Profile (version 1.3)
Output power	Speakerphone: max. 10 dBm Dongle: max. 8 dBm
Typical sensitivity	-89 dBm

Speakerphone | BTD 800 USB

Temperature range	operation: +10 °C to +40 °C / +50 °F to +104 °F storage: -20 °C to +60 °C / -4 °F to +140 °F
Relative humidity	operation: 20% to 85% storage: 10% to 95%

Trademarks

The Bluetooth® word mark and logos are registered trademarks owned by Bluetooth SIG, Inc. and any use of such marks by Sennheiser Communications A/S is under license.

The N-Mark is a trademark or registered trademark of NFC Forum, Inc. in the United States and in other countries. USB Type-C™ and USB-C™ are trademarks of USB Implementers Forum.

EPOS

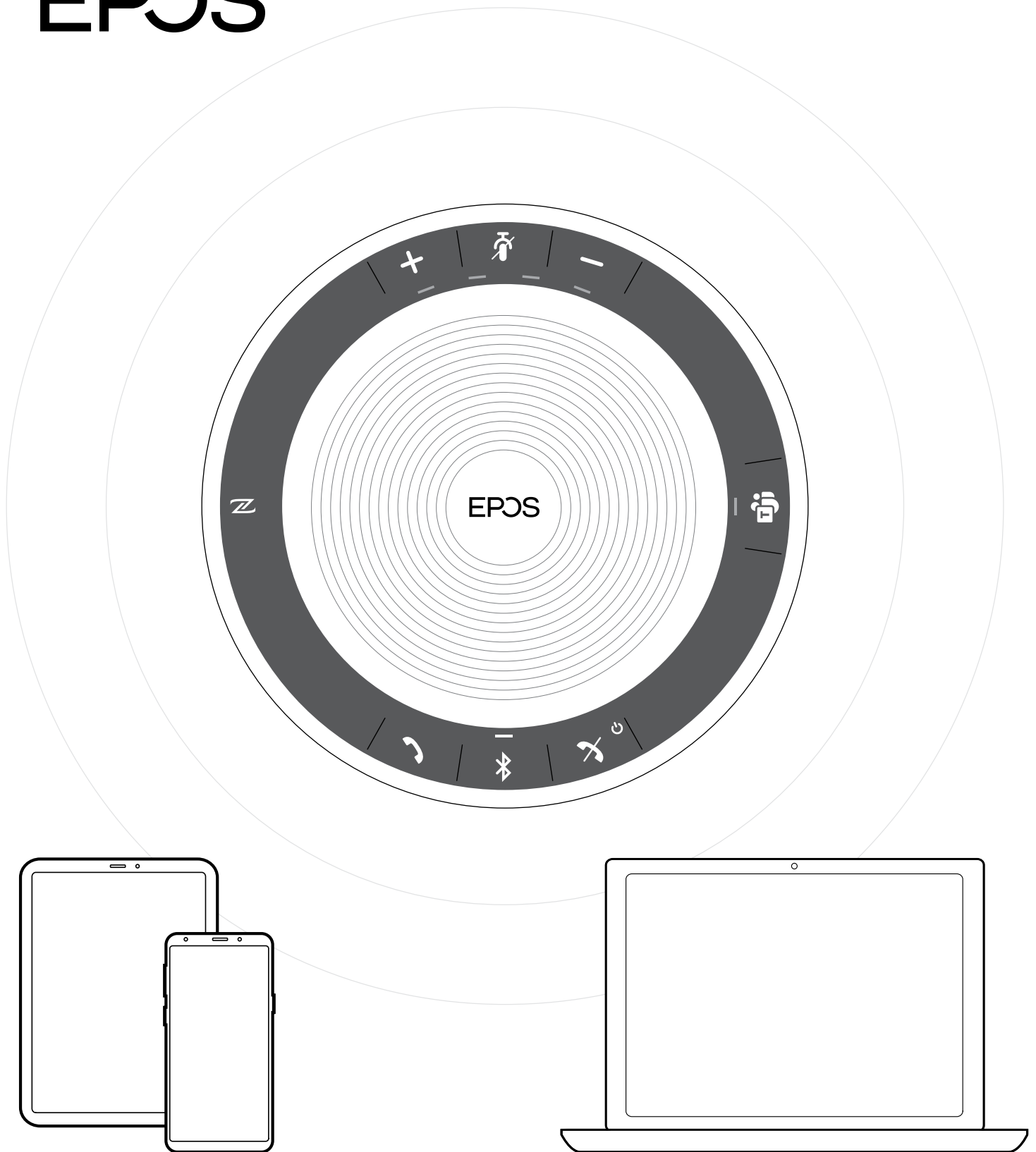

Sennheiser Communications A/S

Industriparken 27, DK-2750 Ballerup, Denmark

www.eposaudio.com