

**TP-LINK®**

| Business Networking Solution

# Installation Guide

**JetStream** Stackable L3 Managed Switch  
T3700G-28TQ



## COPYRIGHT & TRADEMARKS

Specifications are subject to change without notice. **TP-LINK®** is a registered trademark of TP-LINK TECHNOLOGIES CO., LTD. Other brands and product names are trademarks of their respective holders.

No part of the specifications may be reproduced in any form or by any means or used to make any derivative such as translation, transformation, or adaptation without permission from TP-LINK TECHNOLOGIES CO., LTD. Copyright © 2014 TP-LINK TECHNOLOGIES CO., LTD. All rights reserved.

<http://www.tp-link.com>

## FCC STATEMENT



This equipment has been tested and found to comply with the limits for a Class A digital device, pursuant to part 15 of the FCC Rules. These limits are designed to provide reasonable protection against harmful interference when the equipment is operated in a commercial environment. This equipment generates, uses, and can radiate radio frequency energy and, if not installed and used in accordance with the instruction manual, may cause harmful interference to radio communications. Operation of this equipment in a residential area is likely to cause harmful interference in which case the user will be required to correct the interference at his own expense.

This device complies with part 15 of the FCC Rules. Operation is subject to the following two conditions:

- 1) This device may not cause harmful interference.
- 2) This device must accept any interference received, including interference that may cause undesired operation.

Any changes or modifications not expressly approved by the party responsible for compliance could void the user's authority to operate the equipment.

## CE Mark Warning



This is a class A product. In a domestic environment, this product may cause radio interference, in which case the user may be required to take adequate measures.

## Related Document

---

The User Guide and CLI Reference Guide of the product are provided on the resource CD.

To obtain the latest product information, please visit the Official Website:

<http://www.tp-link.com>

## About this Installation Guide

---

This Installation Guide describes the hardware characteristics, installation methods and the points that should be attended to during installation.

This Installation Guide is structured as follows:

**Chapter 1 Introduction.** This chapter describes the External Components of the switch.

**Chapter 2 Preparing For Installation.** This chapter illustrates the safety precautions before installing the switch.

**Chapter 3 Installation.** This chapter illustrates how to install the switch.

**Chapter 4 Lightning Protection.** This chapter illustrates how to prevent lightning damage.

**Chapter 5 Connection.** This chapter illustrates how to do the physical connection of the switch.

**Chapter 6 Configuration.** This chapter instructs you to configure the switch via Web Interface and CLI commands.

**Appendix A Troubleshooting.**

**Appendix B Hardware Specifications.**

**Appendix C Technical Support.**

## Audience

---

This Installation Guide is for:



Network Engineer

Network Administrator

## Conventions

---

This guide uses the specific formats to highlight special messages. The following table lists the notice icons that are used throughout this guide.

	Remind to be careful. A caution indicates a potential which may result in device damage.
	Remind to take notice. The note contains the helpful information for a better use of the product.

# Contents

---

Chapter 1 Introduction	01
1.1 Product Overview	01
1.2 Appearance	01
Chapter 2 Preparing For Installation	05
2.1 Package Contents	05
2.2 Safety Precautions	05
2.3 Installation Tools	07
2.4 Installation & Connection Flow	07
Chapter 3 Installation	09
3.1 Installing the Switch on a Desktop	09
3.2 Installing the Switch Into a 19-inch Rack	09
3.3 Installing & Removing the Power Supply Module	10
3.4 Installing & Removing the Interface Card	11
3.5 Stacking Using Interface Card on Rear Panel	12
Chapter 4 Lightning Protection	14
4.1 Cabling Reasonably	14
4.2 Connect to Ground	16
4.3 Equipotential Bonding	17
4.4 Use Lightning Arrester	18
Chapter 5 Connection	19
5.1 Ethernet Port	19
5.2 SFP Port	19
5.3 Console Port	19
5.4 Verify Installation	20
5.5 Power on via Power Supply Module	20
5.6 Power on via Redundant Power Supply	21
5.7 Initialization	22
Chapter 6 Configuration	23
6.1 Configure the Switch via GUI	23
6.2 Configure the Switch Using CLI	24

Appendix A Troubleshooting	29
Appendix B Hardware Specifications	30
Appendix C Technical Support	31

# Chapter 1 Introduction

## 1.1 Product Overview

T3700G-28TQ is TP-LINK’s JetStream Stackable L3 Managed Switch, supporting up to 4 SFP+ slots. T3700G-28TQ is ideal for large businesses, campuses or SMB networks requiring an outstanding, reliable and affordable 10 Gigabit solution.

T3700G-28TQ supports stacking of up to 8 units, thus providing flexible scalability and protective redundancy for your networks. Moreover, aiming to better protect your network, T3700G-28TQ’s main power is removable. With the help of TP-LINK’s RPS, administrators can easily change its main power if it encounters some problems without shutting down the switch, thus enabling your network to really enjoy the benefit of uninterrupted operation.

## 1.2 Appearance

### ■ Front Panel

The front panel of T3700G-28TQ is shown as the following figure.

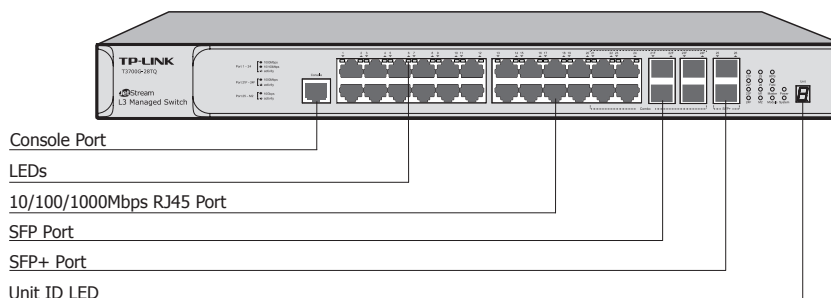

Figure 1-1 Front Panel of T3700G-28TQ

### Console Port

Designed to connect with the serial port of a computer or terminal for monitoring and configuring the switch.

### LEDs

LED	Status	Indication	
Power	On	The switch is powered on	
	Off	The switch is powered off or power supply is abnormal	
	Flashing	Power supply is abnormal	
System	Flashing	The switch works properly	
	On/Off	The switch works improperly	
RPS	On	Green	Both the built-in power supply and the redundant power supply work properly
		Yellow	The built-in power supply works improperly, but the redundant power supply works properly
	Off		The switch is not connected to any redundant power supply



LED	Status	Indication	
FAN	Green	All the fans work properly	
	Yellow	Not all the fans work properly	
Master	On	The switch works as master in the stack system, or does not join any stack system	
	Off	The switch works as slave in the stack system	
Module	On(green)	An Interface Card is connected to the switch and works properly	
	Flashing(yellow)	An Interface Card is connected to the switch, but works improperly	
	Off	No Interface Card is connected to the switch	
Link/Act (Port 1-24)	Green	On	A 1000Mbps device is connected to the corresponding port, but no activity
		Flashing	Data is being transmitted or received
	Yellow	On	A 10/100Mbps device is connected to the corresponding port, but no activity
		Flashing	Data is being transmitted or received
	Off	No device is connected to the corresponding port	
21F-24F	On	An SFP transceiver is connected to the corresponding port, and it is connected to a device, but no activity	
	Flashing	A 1000Mbps device is connected to the corresponding port and transmitting data	
	Off	An SFP transceiver is connected to the corresponding port, but it is not connected to a device, or no SFP transceiver is connected	
25, 26	On	An SFP+ transceiver/cable is connected to the corresponding port, and it is connected to a 10Gbps device, but no activity	
	Flashing	A 10Gbps device is connected to the corresponding port and transmitting data	
	Off	An SFP+ transceiver/cable is connected to the corresponding port, but it is not connected to a device, or no SFP+ transceiver/cable is connected	
M1,M2	On	An SFP+ transceiver/cable is connected to the corresponding port of the Interface Card, and it is connected to a 10Gbps device, but no activity	
	Flashing	A 10Gbps device is connected to the corresponding port of the Interface Card and transmitting data	
	Off	An SFP+ transceiver/cable is connected to the corresponding port of the Interface Card, but it is not connected to a device, or no SFP+ transceiver/cable is connected to the Interface Card, or no Interface Card is connected	

**Port Feature**

Model	10/100/1000Mbps RJ45 Port	Console Port	1000Mbps SFP Port	10Gbps SFP+ Port
T3700G-28TQ	24	1	4(Combo)	4 (2 fixed + 2 optional)

**10/100/1000Mbps Port**

Port 1-24, designed to connect to the device with a bandwidth of 10Mbps, 100Mbps or 1000Mbps. Each has a corresponding 10/100/1000Mbps LED.

**SFP Port**

Port 21F-24F, designed to install the SFP transceiver. These four SFP transceiver slots are shared with the associated RJ45 ports. The associated two ports are referred as a "Combo" port, which means they cannot be used simultaneously, otherwise only SFP port works.

**SFP+ Port**

Port 25-26, designed to install the 10Gbps SFP+ transceiver or SFP+ cables. T3700G-28TQ also provides an interface card slot on the rear panel to install the expansion card (TX432 of TP-LINK for example). If TX432 is installed, you get another two 10Gbps SFP+ ports.

**Unit ID LED**

Designed to display the stack unit ID of the switch. For the switch that does not join any stack system, it displays its default unit ID. To modify the default unit number, please logon to the GUI of the switch and go to **Stack**→**Stack Management**→**Switch Renumber** page.

■ **Rear Panel**

The rear panel of T3700G-28TQ is shown as the following figure.

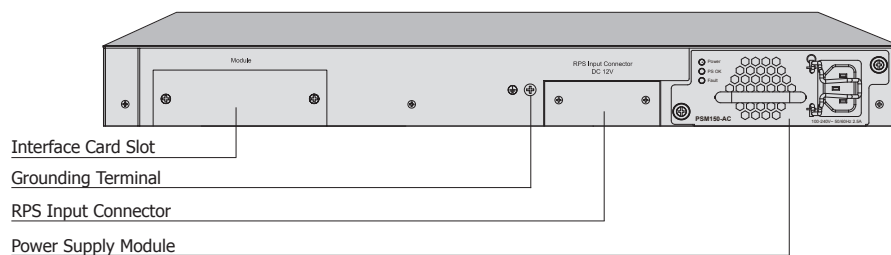

Figure 1-2 Rear Panel of T3700G-28TQ (1)



**Note:** The Interface Card Slot, RPS Input Connector and AC Power Supply Module Slot are shipped with protective covers.

**Interface Card Slot**

Designed to extend the interfaces. You can select an Interface Card (TX432 of TP-LINK for example) for your switch if needed. For how to install an Interface Card, please refer to **3.4 Installing & Removing the Interface Card**.

### Grounding Terminal

The switch already comes with lightning protection mechanism. You can also ground the switch through the PE (Protecting Earth) cable of AC cord or with Ground Cable. For detailed information, please refer to **Chapter 4 Lightning Protection**.

### RPS Input Connector

Designed to connect the RPS (Redundant Power Supply). You can selected an RPS (RPS150 of TP-LINK for example) for your switch if needed. For how to install an RPS, please refer to **5.6 Power on via Redundant Power Supply**.

### Power Supply Module

The AC Power Supply Module PSM150-AC is provided with the switch. It is fully hot swappable, helping to ensure no system interruption during installation or replacement. For how to install/remove the Power Supply Module, please refer to **3.3 Installing & Removing the Power Supply Module**.



**Caution:** Please use the provided power cord.

With all the protective covers removed, and the Interface Card (TX432) & Power Supply Module (PSM150-AC) inserted, the rear panel of T3700G-28TQ is shown as the following figure.

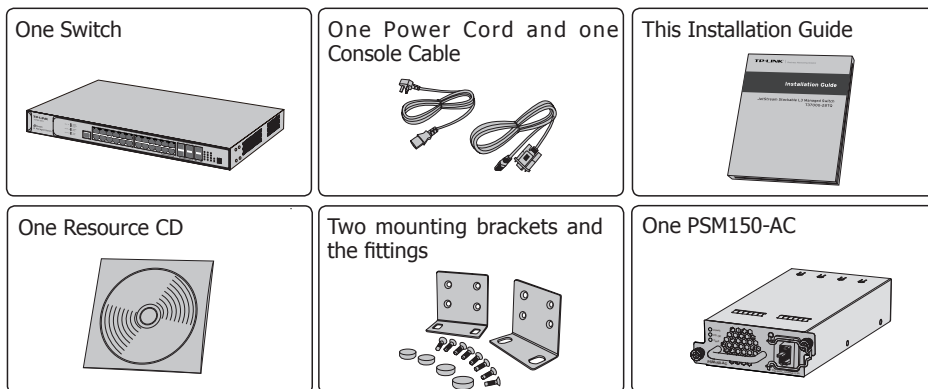

Figure 1-3 Rear Panel of T3700G-28TQ (2)

## Chapter 2 Preparing For Installation

### 2.1 Package Contents

Make sure that the package contains the following items. If any of the listed items is damaged or missing, please contact your distributor.



### 2.2 Safety Precautions

To avoid any device damage and bodily injury caused by improper use, please observe the following rules.

#### ■ Safety Precautions

- Keep the power off during the installation.
- Wear an ESD-preventive wrist strap, and make sure that the wrist strap has a good skin contact and is well grounded.
- Use only the power cord provided with the switch.
- Make sure that the supply voltage matches the specifications indicated on the rear panel of the switch.
- Ensure the vent hole is well ventilated and unblocked.
- Do not open or remove the cover of the switch.
- Before cleaning the device, cut off the power supply. Do not clean it by the waterish cloth, and never use any other liquid cleaning method.

#### ■ Site Requirements

To ensure normal operation and long service life of the device, please install it in an environment that meets the requirements described in the following subsection.

#### Temperature/Humidity



Please keep a proper temperature and humidity in the equipment room. Too high/low humidity may lead to bad insulation, electricity leakage, mechanical property changes and corrosions. Too high temperature may accelerate aging of the insulation materials and can thus significantly shorten the service life of the device. For normal temperature and humidity of the device, please check the following table.

Environment	Temperature	Humidity
Operating	0°C ~ 40°C	10% ~ 90%RH Non-condensing
Storage	-40°C ~ 70°C	5% ~ 90%RH Non-condensing

### Clearness



The dust accumulated on the switch can be absorbed by static electricity and result in poor contact of metal contact points. Some measures have been taken for the device to prevent static electricity, but too strong static electricity can cause deadly damage to the electronic elements on the internal circuit board. To avoid the effect of static electricity on the operation of the switch, please attach much importance to the following items:

- Dust the device regularly, and keep the indoor air clean.
- Keep the device well grounded and ensure static electricity has been transferred.

### Electromagnetic Interference

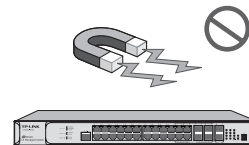

Electronic elements including capacitance and inductance on the device can be affected by external interferences, such as conducted emission by capacitance coupling, inductance coupling, and impedance coupling. To decrease the interferences, please make sure to take the following measures:

- Use the power supply that can effectively filter interference from the power grid.
- Keep the device far from high-frequency, strong-current devices, such as radio transmitting station.
- Use electromagnetic shielding when necessary.

### Lightening Protection



Extremely high voltage currents can be produced instantly when lightning occurs and the air in the electric discharge path can be instantly heated up to 20,000°C. As this

instant current is strong enough to damage electronic devices, more effective lightning protection measures should be taken.

- Ensure the rack and device are well earthed.
- Make sure the power socket has a good contact with the ground.
- Keep a reasonable cabling system and avoid induced lightning.
- Use the signal SPD (Surge Protective Device) when wiring outdoor.



---

**Note:** For detailed lightning protection measures, please refer to **Chapter 4 Lightning Protection**.

---

### Installation Site

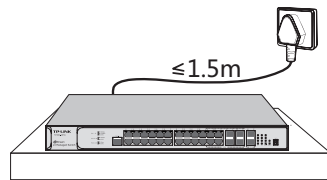

When installing the device on a rack or a flat workbench, please note the following items:

- The rack or workbench is flat and stable, and sturdy enough to support the weight of 5.5kg at least.
- The rack or workbench has a good ventilation system. The equipment room is well ventilated.
- The rack is well grounded. Keep the power socket less than 1.5 meters away from the device.

## 2.3 Installation Tools

---

- Phillips screwdriver
- ESD-preventive wrist wrap
- Cables



---

**Note:** These tools are not provided with our product. If needed, please self purchase them.

---

## 2.4 Installation & Connection Flow

---

T3700G-28TQ provides interfaces to install the swappable Power Supply Module, Interface Card and Redundant Power Supply. The switch is already supplied with a Power Supply Module PSM150-AC, and you can also self-purchase the Interface Card/Redundant Power Supply if needed.

The Installation & Connection flow is shown as the following figure.

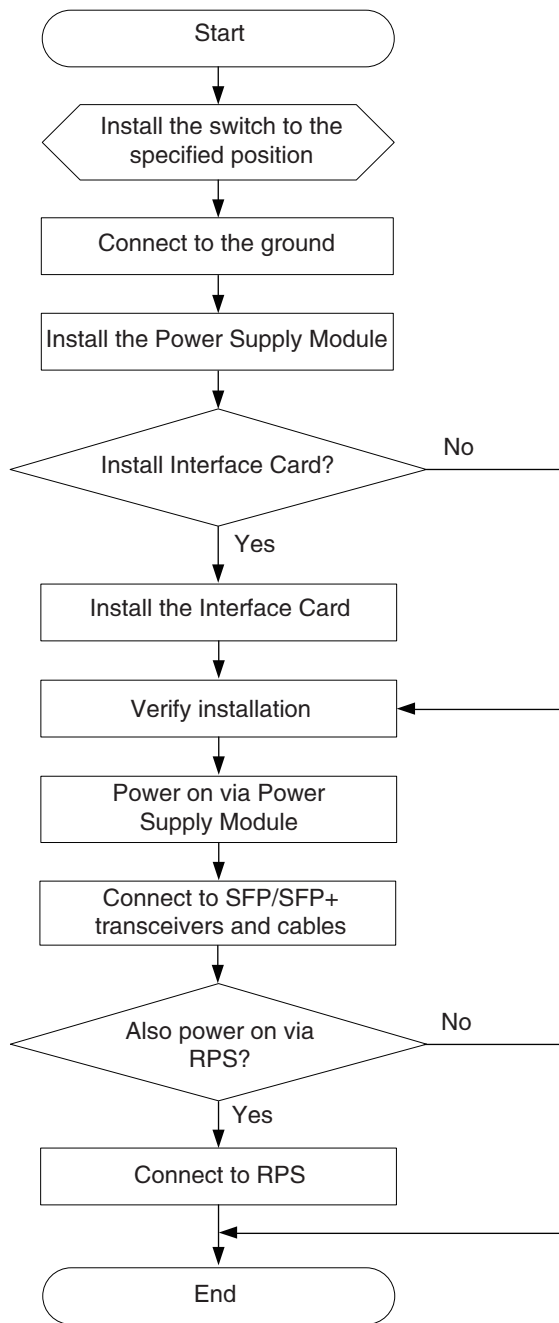

Figure 2-1 Installation & Connection Flow



**Note:** The switch can be powered by the Power Supply Module and Redundant Power Supply simultaneously or individually. If simultaneously, the Power Supply Module and Redundant Power Supply together will enable your network to enjoy the benefit of uninterrupted operation.

## Chapter 3 Installation

### 3.1 Installing the Switch on a Desktop

To install the switch on the desktop, please follow the steps below:

1. Set the switch on a flat surface strong enough to support the entire weight of the device with all fittings.
2. Remove the adhesive backing papers from the rubber feet.
3. Turnover the switch and attach the supplied rubber feet to the recessed areas on the bottom at each corner of the switch.

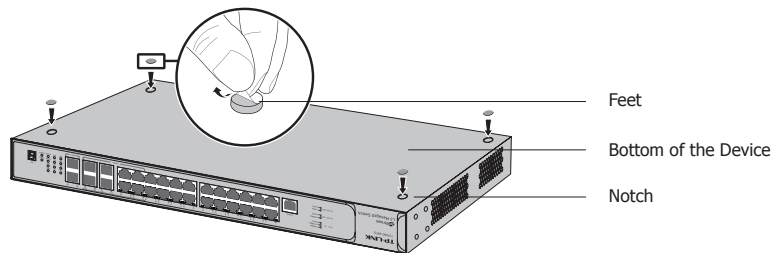

Figure 3-1 Desktop Installation

### 3.2 Installing the Switch Into a 19-inch Rack

To install the switch in an EIA standard-sized, 19-inch rack, follow the instructions described below:

1. Check the grounding and stability of the rack.
2. Secure the supplied rack-mounting brackets to each side of the switch with supplied screws, as illustrated in the following figure.

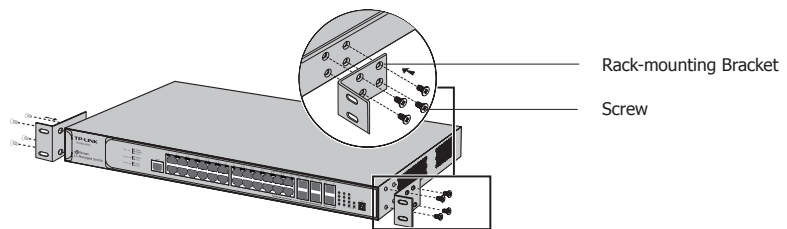

Figure 3-2 Bracket Installation

3. After the brackets are attached to the switch, use suitable screws (not provided) to secure the brackets to the rack, as illustrated in the following figure.



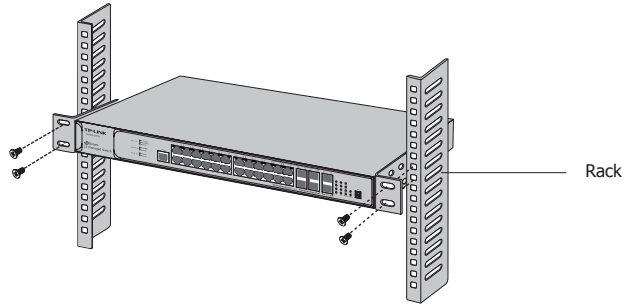

Figure 3-3 Rack Installation



**Caution:**

- Please set 5~10cm gaps around the device for air circulation.
- Please avoid any heavy thing placed on the switch.
- Please mount switches in sequence from the bottom to top of the rack and ensure a certain clearance between switches for the purpose of heat dissipation.

### 3.3 Installing & Removing the Power Supply Module



**Caution:** When you install and remove the module, you should ensure that the power cord is not connected to the module.

■ **Installing the Power Supply Module**

1. Wear an ESD-preventive wrist strap, and make sure that it has good skin contact and is well grounded.
2. Use a Phillips screwdriver to loosen the mounting screws of the protective cover on the power supply module slot of the switch and remove the protective cover, as shown in the following figure.

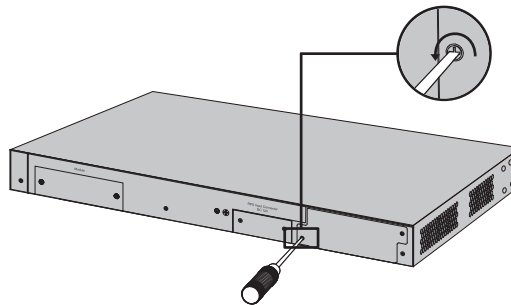

Figure 3-4 Removing the Protective Cover

3. Grip the handle of the module by one hand, and hold the bottom of the module by the other hand. Then gently push the module in along the slot guide rail until the module is flush with the switch, as shown in the following figure.

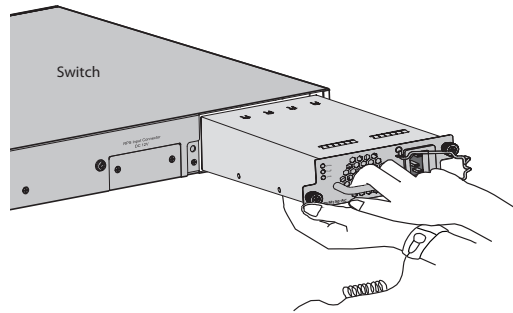

Figure 3-5 Installing the Power Supply Module

4. Tighten the captive screws with a Phillips screwdriver to fix the power supply module in place.

#### ■ Removing the Power Supply Module

1. Wear an ESD-preventive wrist strap, and make sure that it has good skin contact and is well grounded.
2. Remove the power cord from the power module and the external power supply system.
3. Use a Phillips screwdriver to loosen the captive screws at both sides of the power supply module until all spring pressure is released.
4. Pull the handle by one hand towards you along the guide rails, and hold the bottom of the module by the other hand, until it completely comes out of the switch chassis.



#### Note:

When installing or removing a power supply module, pay attention to the following points:

- Make sure that the power supply module is correct vertically in the operation of installation.
- Do not use too much force in the operation. If resistance is encountered or positions of the power supply module appear larger deflection in the operation of installation, you must first remove the module and then reinstall the module.
- If the screws can not be tighten, probably because the power supply module is not installed properly due. Please check carefully.
- In order to better protect the removed power supply module, it is recommended to package it by an antistatic bag.
- After removing the PSM150-AC, please install the protective cover as soon as possible to prevent dust from entering and ensure the normal ventilation in the switch.

### 3.4 Installing & Removing the Interface Card (Optional)

#### ■ Installing the Interface Card

1. Wear an ESD-preventive wrist strap, and make sure that it has good skin contact and is well grounded.
2. Use a Phillips screwdriver to loosen the mounting screws of the protective cover on the interface card slot of the switch and remove the protective cover, similar to the procedure shown in Figure 3-4.

3. Hold the captive screws on the front panel of the interface card, and gently push the interface card in along the slot guide rail until the interface card is flush with the switch, as shown in the following figure.

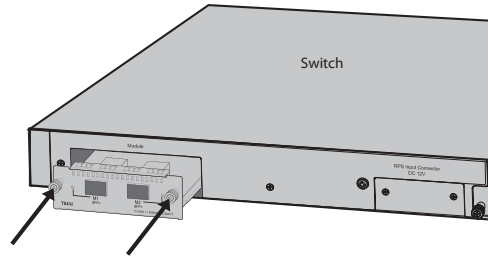

Figure 3-6 Installing the Interface Card

4. Tighten the captive screws with a Phillips screwdriver to fix the interface card in place.

#### ■ Removing the Interface Card

1. Wear an ESD-preventive wrist strap, and make sure that it has good skin contact and is well grounded.
2. Use a Phillips screwdriver to loosen the captive screws at both sides of the interface card until all spring pressure is released.
3. Pull the interface card towards you along the guide rails, until it completely comes out of the switch chassis.



#### Note:

- TX432 supports hot plug, so if necessary you can install or remove the interface card when the switch is operating. However, it is recommended that the power be turned off during installation.
- Do not touch the surface-mounted components directly with your hand while the switch is in operation.
- After removing an interface card, if no new interface card is to be installed, please install the protective cover as soon as possible to prevent dust from entering and ensure the normal ventilation in the switch.

### 3.5 Stacking Using Interface Card on Rear Panel (Optional)

You can connect up to 8 switches to form a stack with a single management IP address. Follow the steps below to connect the switches and configure the stack ports, then the switches will automatically select a master unit and establish a stack. Once the stack is established, you can use the console port of any switch in the stack to manage the stacking system.

You can use either the SFP+ ports on the front panel or the Interface Card on the rear panel to create a stack. Here we take stacking using Interface Card for example.

1. Install an Interface Card (TX432) into the Interface Card Slot of each switch, see **3.4 Installing & Removing the Interface Card**.
2. Log on to the GUI of each switch, go to **Stack**→**Stack Management**→**Stack Config** page to enable the stack mode of port M1 and M2 (port 1/1/1 and 1/1/2 on the GUI). Remember to click **Save Config** after the configuration.

- Power off the switches, and then connect a 10G SFP+ cable (TXC432-CU1M/TXC432-CU3M of TP-LINK for example) between each pair of Interface Cards among the switches, as the following figure shows.

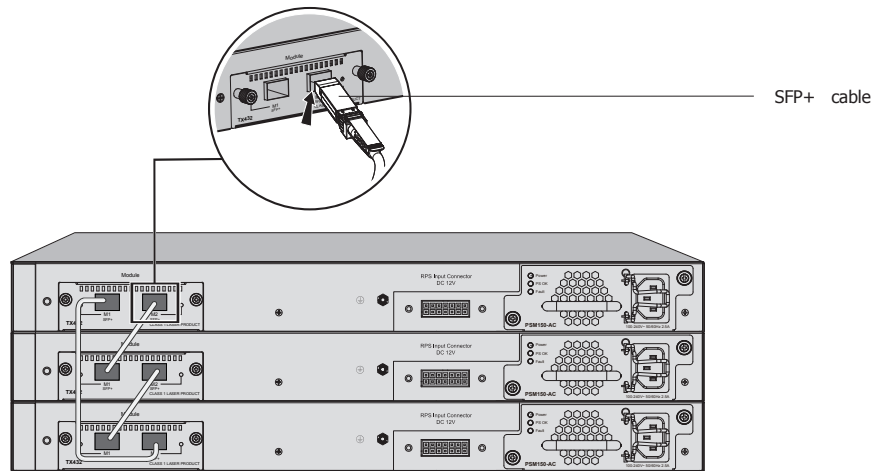

Figure 3-7 Stacking Using Interface Card

- Connect each switch to the next in a cascade to build the backplane of the stack. Finally, connect the last switch in the stack to the first switch, to close the ring and provide redundancy and resiliency to the stack.
- Power on the switches, then the switches will automatically select a master unit. The Master LED of the selected switch will be on.
- To use the console and CLI (Command Line Interface), use a console cable to connect the PC to the console port of any switch in the stack. This single console connection enables you to manage all the switches in the stack.



**Caution:** In the process of using TP-LINK SFP+ Cables, please never bend them into a radius of 45mm (1.77 inch) or less, because it may permanently damage the SFP+ Cables.

## Chapter 4 Lightning Protection

### 4.1 Cabling Reasonably

In the actual network environment, you may need cable outdoors and indoors, and the requirements for cabling outdoors and indoors are different. A reasonable cabling system can decrease the damage of induced lightning to devices.



**Note:** It's not recommended using Ethernet cables outdoors. When cabling outdoors, please use a signal lightning arrester.

#### ■ Requirements for Cabling Outdoors

- Aerial cabling without safeguard is not allowed.

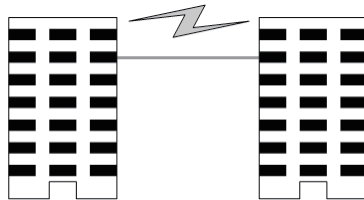

- It's not allowed cabling down the building to connect network devices in different floors.



- Outdoor cables should be buried and paved to the indoor through basement. A piece of steel wire should be paved underground along the pipe and connected to the lightning protection terminal of the building for shielding. Before connecting the cable to the device, install a signal lightning arrester on the corresponding port.
- When an aerial cable is set up, the cable should be through a metal pipe (15m long at least) before coming into the building. The two ends of this metal pipe should be grounded. Before connecting the cable to the device, install a signal lightning arrester on the corresponding port.
- It's not necessary to pave STP cables through pipes. The shielded layer of STP cable should be well grounded. Before connecting the cable to the device, install a signal lightning arrester on the corresponding port.

#### ■ Requirements for Cabling Indoors

When cabling indoors, keep a certain distance away from the devices that may cause high-frequency interferences, such as down-conductor cable, powerline, power transformer and electromotor.

- The main cable should be paved in the metal raceway of the access shaft. When cabling, keep the loop area formed by the cable itself as small as possible.

- Requirements for the distance between Ethernet cable and other pipelines are shown in the table.

Other Pipelines	Ethernet Cable	
	Min Parallel Net Length L (mm)	Min Parallel-overlapping Net Height H (mm)
Down-conductor	1000	300
PE	50	20
Service pipe	150	20
Compressed air pipe	150	20
Thermal pipe (not wrapped)	500	500
Thermal pipe (wrapped)	300	300
Gas pipe	300	20

The two diagrams below demonstrate parallel net length and parallel-overlapping net height.

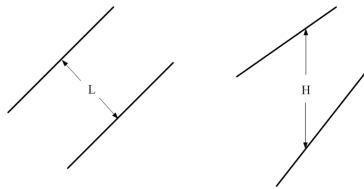

**Note:** The above minimum net length/height is required when metal raceway is not used. If any requirements cannot be met, you can add a steel tube or metal raceway for shielding.

- Requirements for the distance between Ethernet cable and high-power electric devices are in following tables.

Cable	Pave Way	Min Parallel Length (mm)
<2kVA powerline	Parallel cabling	130
	One is in the grounded metal raceway or metal pipe	70
	The both are in the grounded metal raceway or metal pipe	10
2~5kVA powerline	Parallel cabling	300
	One is in the grounded metal raceway or metal pipe	150
	The both are in the grounded metal raceway or metal pipe	80
>5kVA powerline	Parallel cabling	600
	One is in the grounded metal raceway or metal pipe	300
	The both are in the grounded metal raceway or metal pipe	150

Device	Min Distance (m)
Switch case	1.00
Transformer room	2.00
Elevator tower	2.00
Air-conditioner room	2.00

## 4.2 Connect to Ground

Connecting the device to ground is to quickly release the lightning over-voltage and over-current of the device, which is also a necessary measure to protect the body from electric shock.

In different environments, the device may be grounded differently. The following will instruct you to connect the device to the ground in two ways, connecting to the grounding bar or connecting to the ground via the power cord. Please connect the device to ground in the optimum way according to your specific operation environment.

### ■ Connecting to the Grounding Bar

If the device is installed in the Equipment Room, where a grounding bar is available, you are recommended to connect the device to the Grounding Bar as shown in the following figure.

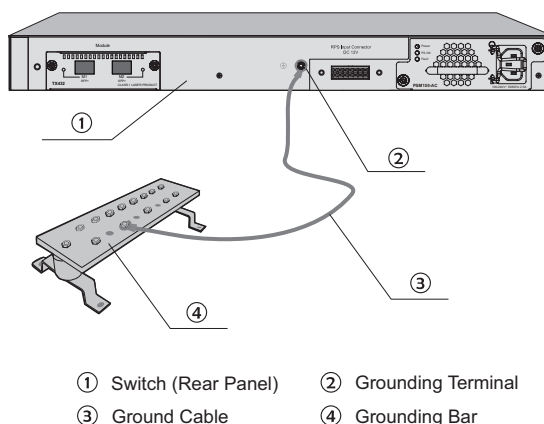

Figure 4-1 Connecting to the Grounding Bar



**Note:** The grounding bar and ground cable are not provided with our product. If needed, please self purchase them.

### ■ Connecting to the Ground via the Power Supply

If the device is installed in the normal environment, the device can be grounded via the PE (Protecting Earth) cable of the AC power supply as shown in the following figure (take powered by the Power Supply Module PSM150-AC for example).

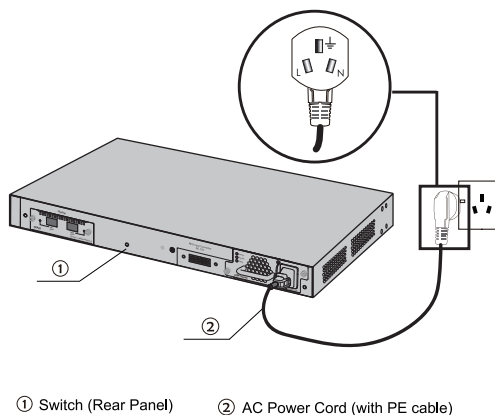

Figure 4-2 Connecting to the Ground



**Note:**

- The figure is to illustrate the application and principle. The power cord you get from the package and the socket in your situation will comply with the regulation in your country, so they may differ from the figure above.
- If you intend to connect the device to the ground via the PE (Protecting Earth) cable of AC power cord, please make sure the PE (Protecting Earth) cable in the electrical outlet is well grounded in advance.

### 4.3 Equipotential Bonding

Equipotential Bonding is the practice of intentionally electrically connecting all earthed systems to the same grounding grid or connecting the grounding grids of all the earthed systems together through the ground or overground metal so as to create an earthed equipotential zone. When lightning occurs, the high voltage produced by lightning current in all systems will meanwhile exist in their ground cables, and thus all ground cables have the same electrical potential and basically eliminate the electric strikes between the systems.

The figure bellow illustrates how to practice equipotential bonding in a network.

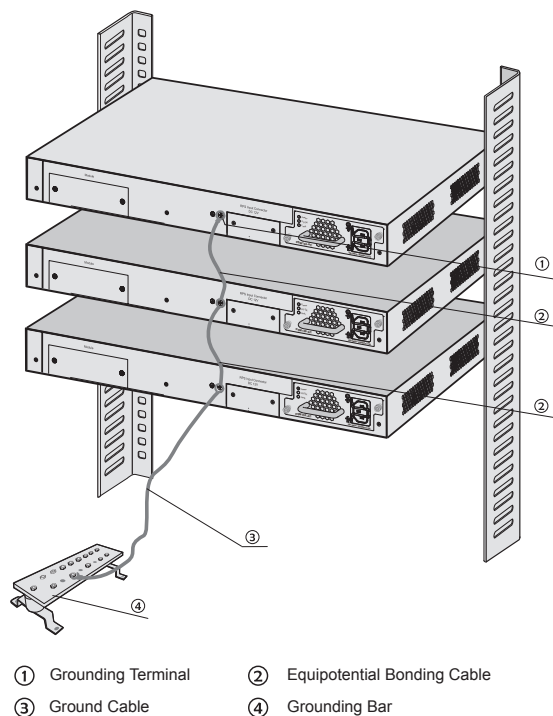

Figure 4-3 Equipotential Bonding

When equipotential bonding, please note that the cable should be copper wrapped Kelly with its area being 6mm<sup>2</sup> at least. The shorter cable the better, and use a grounding bar to establish an equipotential bonding point.



**Note:** The equipotential bonding cable is not provided with our product. If needed, please self purchase it.



## 4.4 Use Lightning Arrester

Power lightning arrester and signal lightning arrester are used for lightning protection.

Power lightning arrester is used for limiting the voltage surge due to a lightning. If an outdoor AC power cord should be directly connected to the device, please use a power lightning arrester.



**Note:** Power lightning arrester is not provided with our product. If needed, please self purchase it.

Signal lightning arrester is used to protect RJ45 ports of the device from lightning. When cabling outdoors, please install a signal lightning arrester before connecting the cable to the device.

When purchasing or using a signal lightning arrester, please observe the following rules:

- The port rate of the signal lightning arrester should match the rate of the desired port on the device. If it is not matched, this signal lightning arrester will not work. Purchase a standard lightning arrester.
- Install signal lightning arrester near the protected device and connect it to the ground via a shorter ground cable.

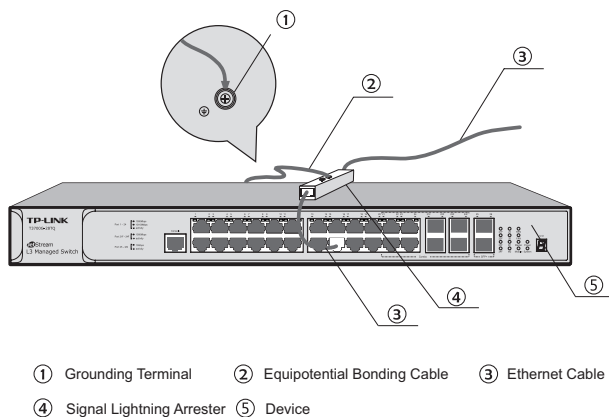

Figure 4-4 Lightning Arrester Connection



**Note:** Signal lightning arrester is not provided with our product. If needed, please self purchase it.

## Chapter 5 Connection

---

### 5.1 Ethernet Port

---

Connect the Ethernet ports of the switch to the network devices by RJ45 cable as the following figure shown.

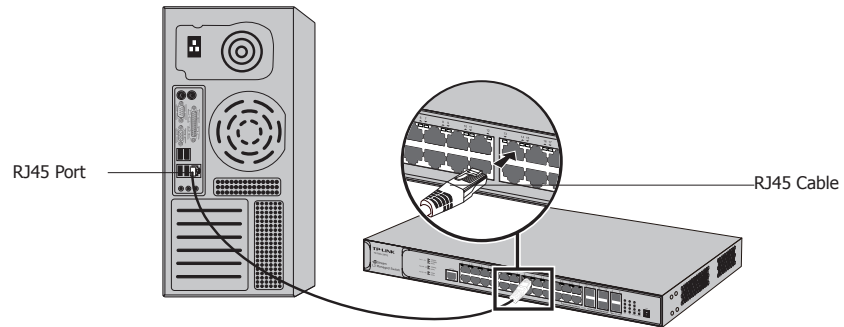

Figure 5-1 Connecting the RJ45 Port

### 5.2 SFP Port

---

Connect an SFP transceiver to the SFP port . For the switch, if an RJ45 port which is combo with SFP port has a valid link, the associated SFP port will be disabled and cannot be used.

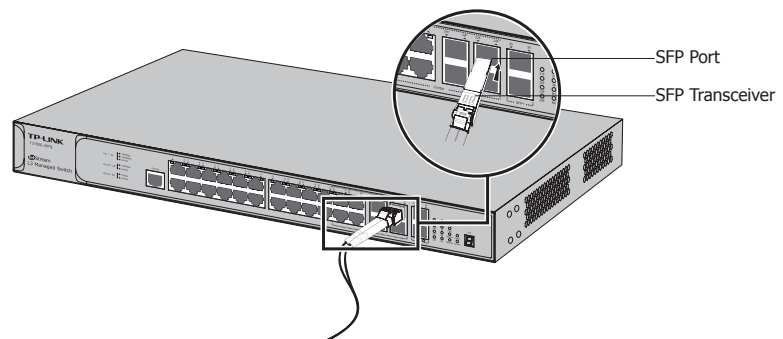

Figure 5-2 Inserting the SFP Transceiver

### 5.3 Console Port

---

CLI enables you to manage the switch, thus you can load the CLI after connecting the PCs or Terminals to the console port on the switch via the provided cable.

Connect the console port of the device with your computer by the console cable as the following figure shown.

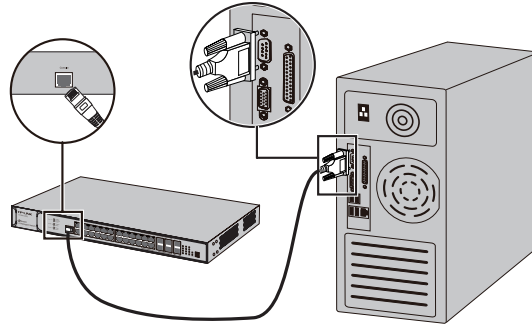

Figure 5-3 Connecting the Console Port

You can also manage the device through the console port, for details please refer to the CLI Reference Guide on the resource CD.



**Note:**

- The console port is the first port on the left of the front panel.
- Please keep the device power off when plugging the console cable.
- Do not connect the console port with other ports by RJ45 cable.

### 5.4 Verify Installation

After completing the installation, please verify the following items:

- There are 5~10cm of clearance around the sides of the device for ventilation and the air flow is adequate.
- The voltage of the power supply meets the requirement of the input voltage of the device.
- The power socket, device and rack are well grounded.
- The device is correctly connected to other network devices.

### 5.5 Power on via Power Supply Module

After the Power Supply Module (PSM150-AC for example) is installed on the switch, you can connect the power cord as the steps shown below.

1. Pull the lock hook of the power cord to the right.
2. Plug one end of the power cord to the power socket of the power supply module, as the arrow ① in Figure 5-4 shown.
3. Pull the lock hook to the left to lock the power cord, as the arrow ② in Figure 5-4 shown.
4. Plug the other end of the power cord into the power socket of the external power supply system.

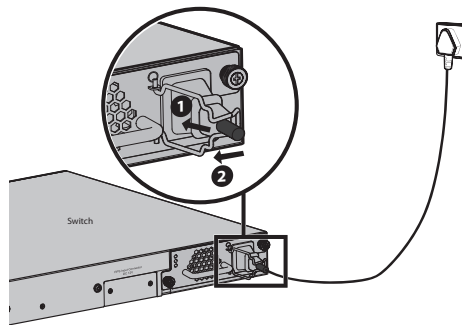

Figure 5-4 Power on via PSM150-AC



**Note:** The figure is to illustrate the application and principle. The power cord you get from the package and the socket in your situation will comply with the regulation in your country, so they may differ from the figure above.

### 5.6 Power on via Redundant Power Supply (Optional)

Follow the steps below to connect the Redundant Power Supply (RPS150 for example) to T3700G-28TQ.

1. Confirm that the power supply of the RPS150 is cut off.
2. Remove the protective covers covering the redundant power socket of RPS150 and the switch, similar to the procedure shown in Figure 2-4.
3. Connect the RPS150 and the switch with DC power cord, as illustrated in Figure 5-5. One end of the DC power cord is marked by the letters "TOP" and the other end has a positioning card attached to it. Plug the end with the letters "TOP" into the input socket of the switch with "TOP" facing up and the other end with positioning card into the DC output socket of the RPS150 with the positioning card facing up.



**Caution:** Make sure the power supply of RPS150 is cut off when connecting or disconnecting RPS150 and the switch, otherwise both RPS150 and the switch may work abnormally or even be damaged.

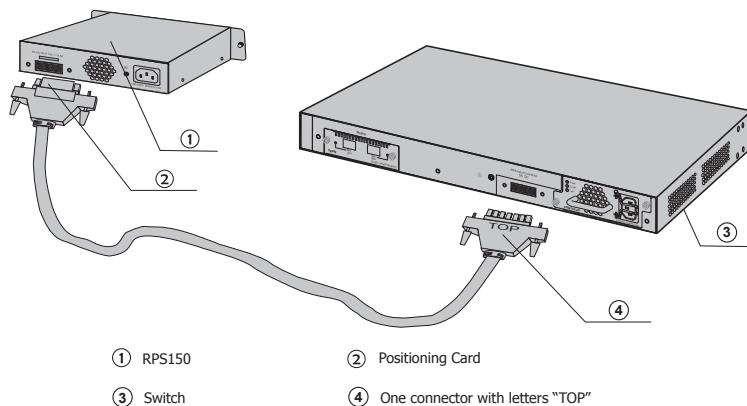

Figure 5-5 Power on via RPS150

## 5.7 Initialization

---

After the device is powered on, it begins the Power-On Self-Test. A series of tests run automatically to ensure the device functions properly. During this time, its LED indicators will respond as follows:

- The Power LED indicator will light on all the time.
- After keeping off for several seconds, the rest of the LED indicators will flash momentarily, and then work as the table in **1.2 Appearance** shows after the initialization.

## Chapter 6 Configuration

---

### 6.1 Configure the Switch via GUI

---



**Note:** To log on to the GUI of the switch, the IP address of your PC should be set in the same subnet addresses of the switch. The IP address is 192.168.0.x ("x" is any number from 2 to 254), Subnet Mask is 255.255.255.0.

---

1. To access the GUI of the switch, open a web browser and type in the default management address `http://192.168.0.1` in the address field of the browser, then press the Enter key.

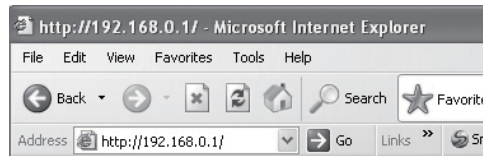

Figure 6-1 Web Browser

2. Enter admin for the default User Name and Password, both in lower case letters. Then click the Login button or press the Enter key.



Figure 6-2 Login

3. After a successful login, the main page will appear as the following figure, and you can configure the function by clicking the setup menu on the left side of the screen.

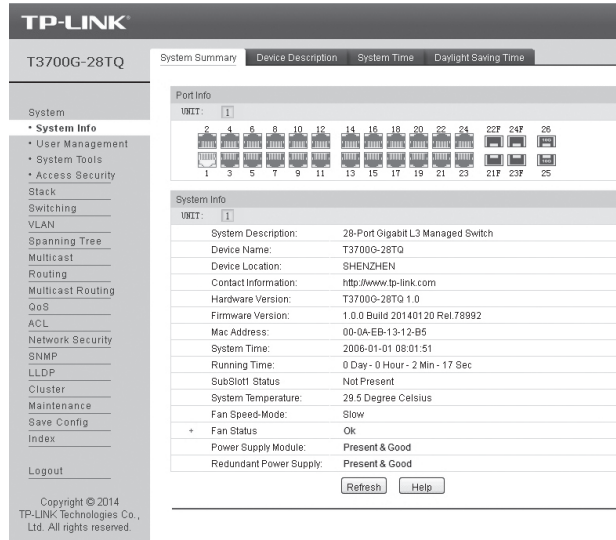

Figure 6-3 Main Page of the Switch

## 6.2 Configure the Switch Using CLI

You can log on to the switch and access the CLI by the following two methods:

- Log on to the switch by the console port on the switch.
- Log on to the switch remotely by a Telnet or SSH connection through an Ethernet port.

### ■ Logon by a Console Port

To log on to the switch by the console port on the switch, please take the following steps:

1. Connect the PCs or Terminals to the console port on the switch by a provided cable.
2. Click Start→All Programs→Accessories→Communications→Hyper Terminal to open the Hyper Terminal as the following figure shown.

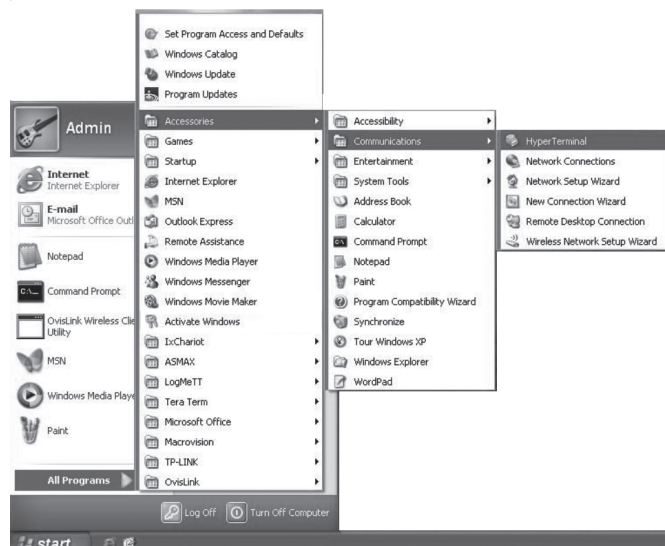

Figure 6-4 Open Hyper Terminal

3. The Connection Description Window will prompt as Figure 6-5. Enter a name into the Name field and click OK.

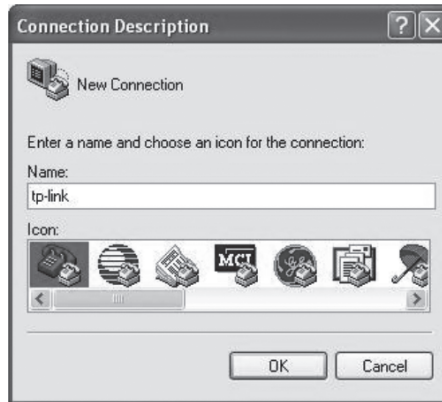

Figure 6-5 Connection Description

4. Select the port to connect in Figure 6-6, and click OK.



Figure 6-6 Select the port to connect

5. Configure the port selected in the step above as the following Figure 6-7 shown. Configure Bits per second as 38400, Data bits as 8, Parity as None, Stop bits as 1, Flow control as None, and then click OK.



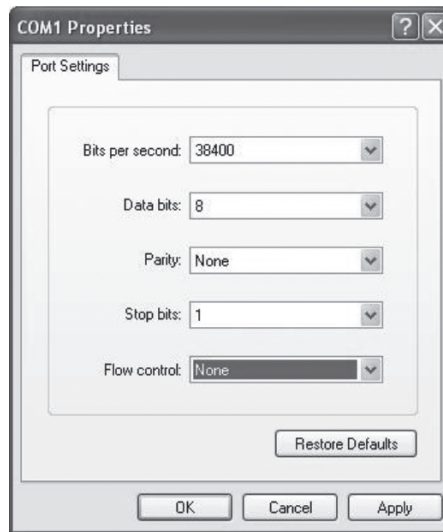

Figure 6-7 Port Settings

6. Type in the User name and Password in the Hyper Terminal window, the factory default value for both of them is admin. The DOS prompt "T3700G-28TQ>" will appear after pressing the Enter button as Figure 6-8 shown. It indicates that you can use the CLI now.

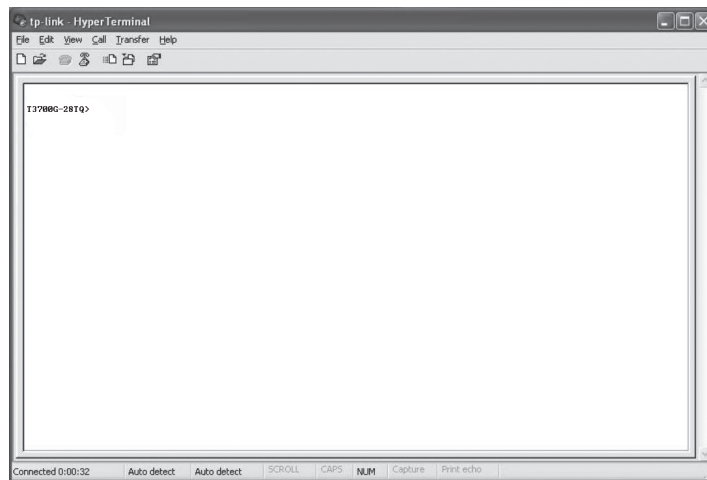

Figure 6-8 Log in the switch

### ■ Logon by Telnet

To log on to the switch by a Telnet connection, please take the following steps:

1. Firstly CLI commands about configuring Telnet login mode, login authentication information and Privileged EXEC Mode password should be configured through Console connection. For more details please refer to the CLI Reference Guide on the resource CD. Here we take login local mode as an example.
2. Make sure the switch and the PC are in the same LAN.
3. Click Start→Run to open the Run window.



Figure 6-9 Open the Run window

4. Type in cmd in the prompt Run window as Figure 6-10 and click OK.

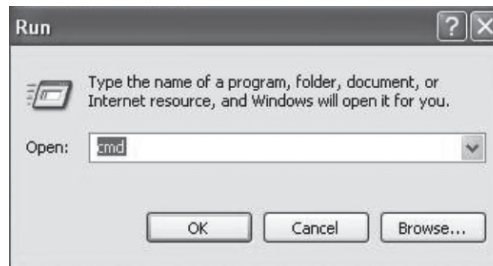

Figure 6-10 Run Window

5. Type in telnet 192.168.0.1 in the command prompt shown as Figure 6-11, and press the Enter button.

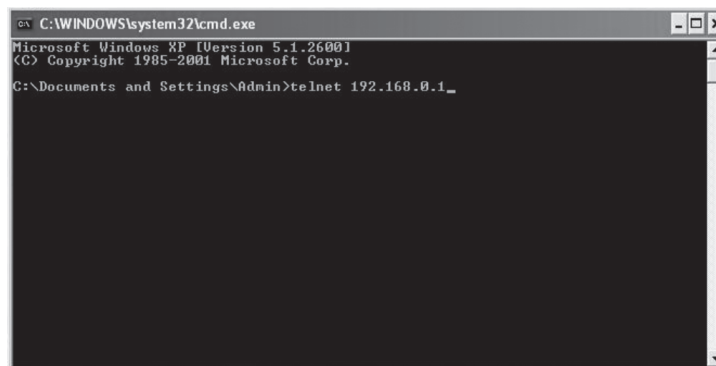
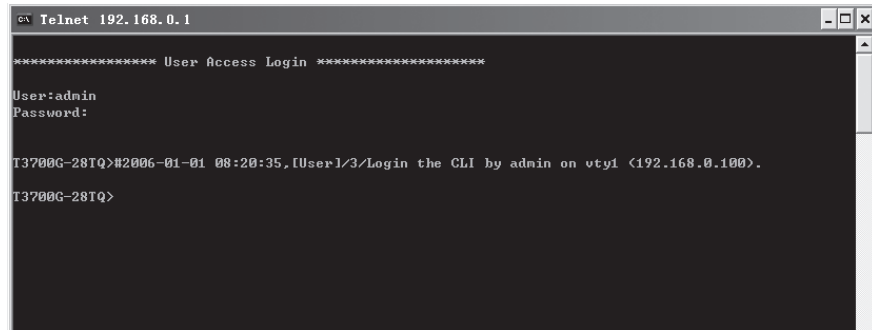

Figure 6-11 Connecting to the switch

6. Type in the User name and Password (the factory default value for both of them is admin) and press the Enter button, then you can use the CLI now, which is shown as Figure 6-12.



```
Telnet 192.168.0.1
***** User Access Login *****
User:admin
Password:

T3700G-28TQ#2006-01-01 08:20:35,[User1/3/Login the CLI by admin on vty1 (192.168.0.100).
T3700G-28TQ>
```

Figure 6-12 Log in the switch

For detailed CLI configuration instructions, please refer to the CLI Reference Guide on the resource CD.

## Appendix A Troubleshooting

### Q1. What could I do if I forgot the username and password of the switch?

1. Connect the console port of the PC to the console port of the switch and open hyper terminal.
2. Power off and restart the switch. When you are prompted that "Press CTRL-B to enter the bootUtil" in the hyper terminal, please press CTRL-B key to enter into bootUtil menu shown as the following figure.

```

*****
*          TPLINK  BOOTUTIL(v1.0.0)          *
*****
Copyright (c) 2013 TPLINK
Create Date: Oct 15 2013 11:34:56

Boot Menu
0 - Print this boot menu
1 - Reboot
2 - Reset
3 - Start
4 - Start and ignore the configuration file
5 - Set ip address
6 - Select startup configuration file
7 - Activate backup image
8 - Download a configuration file
9 - Download a image file
    
```

3. Enter the number 2 to reset the system. Th system will be reset to the factory default settings, and the default login user name and password are both admin.

### Q2. Why does the Power LED work abnormally?

The Power LED should be lit up when the power system works normally. If the Power LED worked abnormally, please take the following steps:

1. Make sure that the power cable is connected properly, and the power contact is normal.
2. Make sure the voltage of the power supply meets the requirement of the input voltage of the switch.

### Q3. What could I do if I could not access the web-based configuration page?

You are recommended to check the following items:

1. Check every port LED on the switch and make sure the cable is installed properly.
2. Try another port on the switch and make sure the cable meets the requirement and works normally.
3. Turn off the power. After a while, turn on the power again.
4. Make sure the IP address of your PC is set within the subnet of the switch.
5. If you still cannot access the configuration page, please restore the switch to its factory defaults. Then the IP address should be set as 192.168.0.x ("x" is any number from 2 to 254) and Subnet Mask as 255.255.255.0.

### Q4. Why does the hyper terminal display abnormally?

Please check as follows:

1. Make sure the power supply is normal and the console cable is properly connected.
2. Check if the console cable is the right type.
3. Ensure the parameters of the hyper terminal are correct: configure Bits per second as 38400, Data bits as 8, Parity as None, Stop bits as 1, and Flow control as None.

## Appendix B Hardware Specifications

Item	Content
Standards	IEEE 802.3 10Base-T Ethernet
	IEEE 802.3u 100Base-TX/100Base-FX
	IEEE 802.3ab 1000Base-T
	IEEE 802.3z 1000Base-X
	IEEE 802.3ae 10GBASE-SR
	IEEE 802.3ae 10GBASE-LR
	IEEE 802.3x Flow Control
Transmission Medium	10Base-T: UTP/STP of Cat. 3 or above
	100Base-TX: UTP/STP of Cat. 5 or above
	100Base-FX: MMF or SMF SFP Transceiver
	1000Base-T: 4-pair UTP ( $\leq 100\text{m}$ ) of Cat. 5, Cat. 5e, and Cat. 6 or above
	1000Base-X: MMF or SMF SFP Transceiver
	10GBASE-SR: MMF SFP+ Transceiver
	10GBASE-LR: SMF SFP+ Transceiver
LEDs	Power, System, RPS, FAN, Master, Module, M1, M2, 10/100/1000Mbps, Unit ID LED
Operating Temperature	0°C~40°C
Storage Temperature	-40°C~70°C
Operating Humidity	10%~90%RH Non-condensing
Storage Humidity	5%~90%RH Non-condensing

## Appendix C Technical Support

- For more help, please go to: <http://www.tp-link.com/en/support/faq>
- To download the latest Firmware, Driver, Utility and User Guide, go to: <http://www.tp-link.com/en/support/download>
- For all other technical support, please contact us by using the following details:

Global	Tel: +86 755 2650 4400 Fee: Depending on rate of different carriers, IDD. E-mail: <a href="mailto:support@tp-link.com">support@tp-link.com</a> Service time: 24hrs, 7 days a week
Australia/New Zealand	Tel: AU 1300 87 5465 (Depending on 1300 policy.) NZ 0800 87 5465 (Toll Free) E-mail: <a href="mailto:support.au@tp-link.com">support.au@tp-link.com</a> (Australia) <a href="mailto:support.nz@tp-link.com">support.nz@tp-link.com</a> (New Zealand) Service time: 24hrs, 7 days a week
Brazil	Toll Free: 0800 608 9799 (Portuguese Service) E-mail: <a href="mailto:suporte.br@tp-link.com">suporte.br@tp-link.com</a> Service time: Monday to Saturday, 09:00 to 20:00; Saturday, 09:00 to 15:00
France	Tel: 0820 800 860 (French service) Fee: 0.118 EUR/min from France Email: <a href="mailto:support.fr@tp-link.com">support.fr@tp-link.com</a> Service time: Monday to Friday 9:00 to 18:00 *Except French Bank holidays
Germany/Austria	Tel: +49 1805 875 465 (German Service) +49 1805 TPLINK +49 820 820 360 Fee: Landline from Germany: 0.14EUR/min. Landline from Austria: 0.20EUR/min. E-mail: <a href="mailto:support.de@tp-link.com">support.de@tp-link.com</a> Service time: Monday to Friday, 9:00 to 12:30 and 13:30 to 17:30. GMT+ 1 or GMT+ 2 (DST in Germany) *Except bank holidays in Hesse
Indonesia	Tel: (+62) 021 6386 1936 Fee: Depending on rate of different carriers. E-mail: <a href="mailto:support.id@tp-link.com">support.id@tp-link.com</a> Service time: Monday to Friday 9:00 to 18:00 *Except public holidays
Italy	Tel: +39 023 051 9020 Fee: Depending on rate of different carriers. E-mail: <a href="mailto:support.it@tp-link.com">support.it@tp-link.com</a> Service time: Monday to Friday, 9:00 to 13:00 and 14:00 to 18:00
Malaysia	Toll Free: 1300 88 875 465 Email: <a href="mailto:support.my@tp-link.com">support.my@tp-link.com</a> Service time: 24hrs, 7 days a week
Poland	Tel: +48 (0) 801 080 618 +48 223 606 363 (if calls from mobile phone) Fee: Depending on rate of different carriers. E-mail: <a href="mailto:support.pl@tp-link.com">support.pl@tp-link.com</a> Service time: Monday to Friday 9:00 to 17:00. GMT+1 or GMT+2 (DST)
Russian Federation	Tel: 8 (499) 754 5560 (Moscow NO.) 8 (800) 250 5560 (Toll-free within RF) E-mail: <a href="mailto:support.ru@tp-link.com">support.ru@tp-link.com</a> Service time: From 9:00 to 21:00 (Moscow time) *Except weekends and holidays in RF
Singapore	Tel: +65 6284 0493 Fee: Depending on rate of different carriers. E-mail: <a href="mailto:support.sg@tp-link.com">support.sg@tp-link.com</a> Service time: 24hrs, 7 days a week

Switzerland	<p>Tel: +41 (0) 848 800 998 (German Service)                  Fee: 4-8 Rp/min, depending on rate of different time.                  E-mail: support.ch@tp-link.com                  Service time: Monday to Friday, 9:00 to 12:30 and 13:30 to 17:30.                  GMT+ 1 or GMT+ 2 (DST)</p>
Turkey	<p>Tel: 0850 7244 488 (Turkish Service)                  Fee: Depending on rate of different carriers.                  E-mail: support.tr@tp-link.com                  Service time: 9:00 to 21:00, 7 days a week</p>
UK	<p>Tel: +44 (0) 845 147 0017                  Fee: Landline: 1p-10.5p/min, depending on the time of day.                  Mobile: 15p-40p/min, depending on your mobile network.                  E-mail: support.uk@tp-link.com                  Service time: 24hrs, 7 days a week</p>
Ukraine	<p>Tel: 0800 505 508                  Fee: Free for Landline; Mobile: Depending on rate of different carriers.                  E-mail: support.ua@tp-link.com                  Service time: Monday to Friday 10:00 to 22:00</p>
USA/Canada	<p>Toll Free: +1 866 225 8139                  E-mail: support.usa@tp-link.com                  Service time: 24hrs, 7 days a week</p>

**TP-LINK®**  
The Reliable Choice

---

Website: <http://www.tp-link.com>

Tel: +86 755 26504400

E-mail: [support@tp-link.com](mailto:support@tp-link.com)

7106504527 REV1.0.0