

BRIO 100

Setup Guide
Guide d'installation

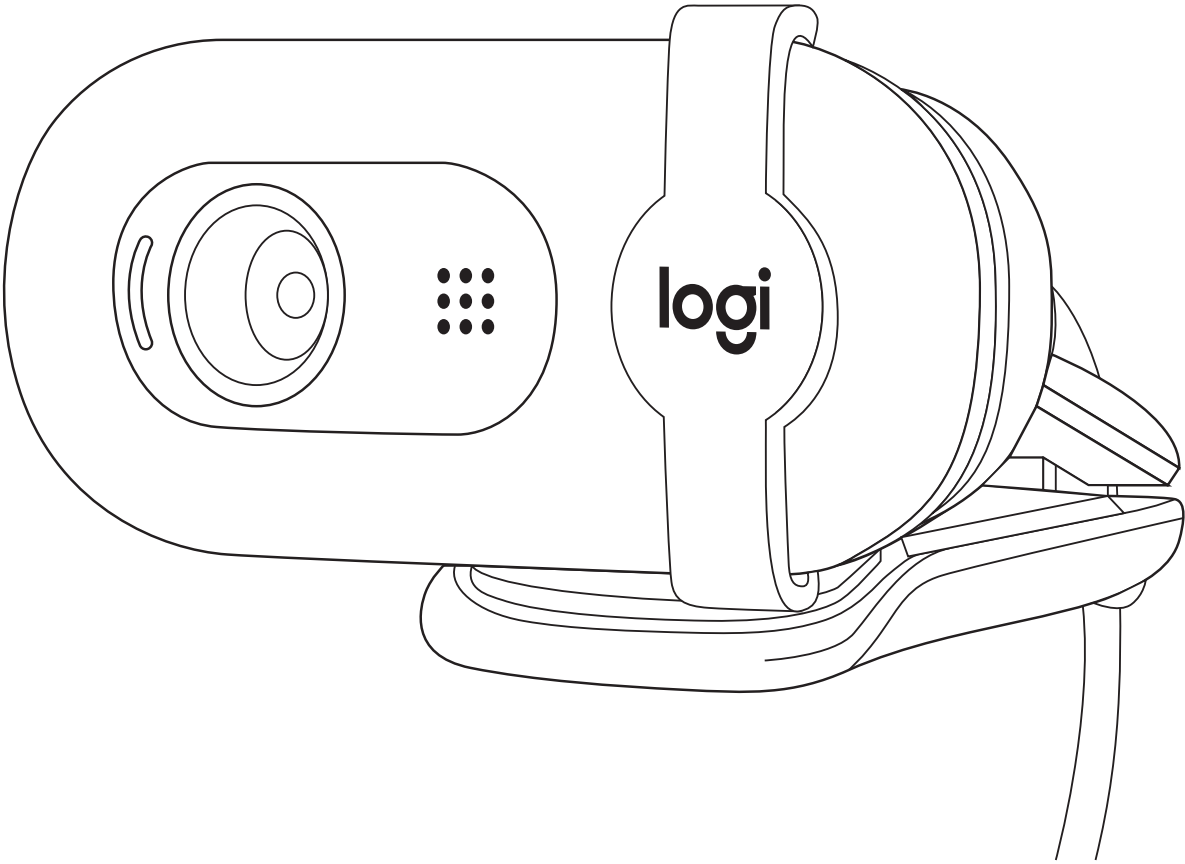

CONTENTS

| | | | |
|-----------------------|----|-----------------------|----|
| English | 3 | Slovenčina | 51 |
| Deutsch | 6 | Українська | 54 |
| Français | 9 | Eesti | 57 |
| Italiano | 12 | Latviski | 60 |
| Español | 15 | Lietuvių | 63 |
| Português | 18 | Български | 66 |
| Nederlands | 21 | Hrvatski | 69 |
| Svenska | 24 | Srpski | 72 |
| Dansk | 27 | Slovenščina | 75 |
| Norsk | 30 | Română | 78 |
| Suomi | 33 | Türkçe | 81 |
| Ελληνικά | 36 | 84 العربية | |
| По-русски | 39 | 87. עברית | |
| Po polsku | 42 | 繁體中文 | 90 |
| Magyar | 45 | 한국어 | 93 |
| Česká verze | 48 | Indonesia | 96 |

KNOW YOUR PRODUCT

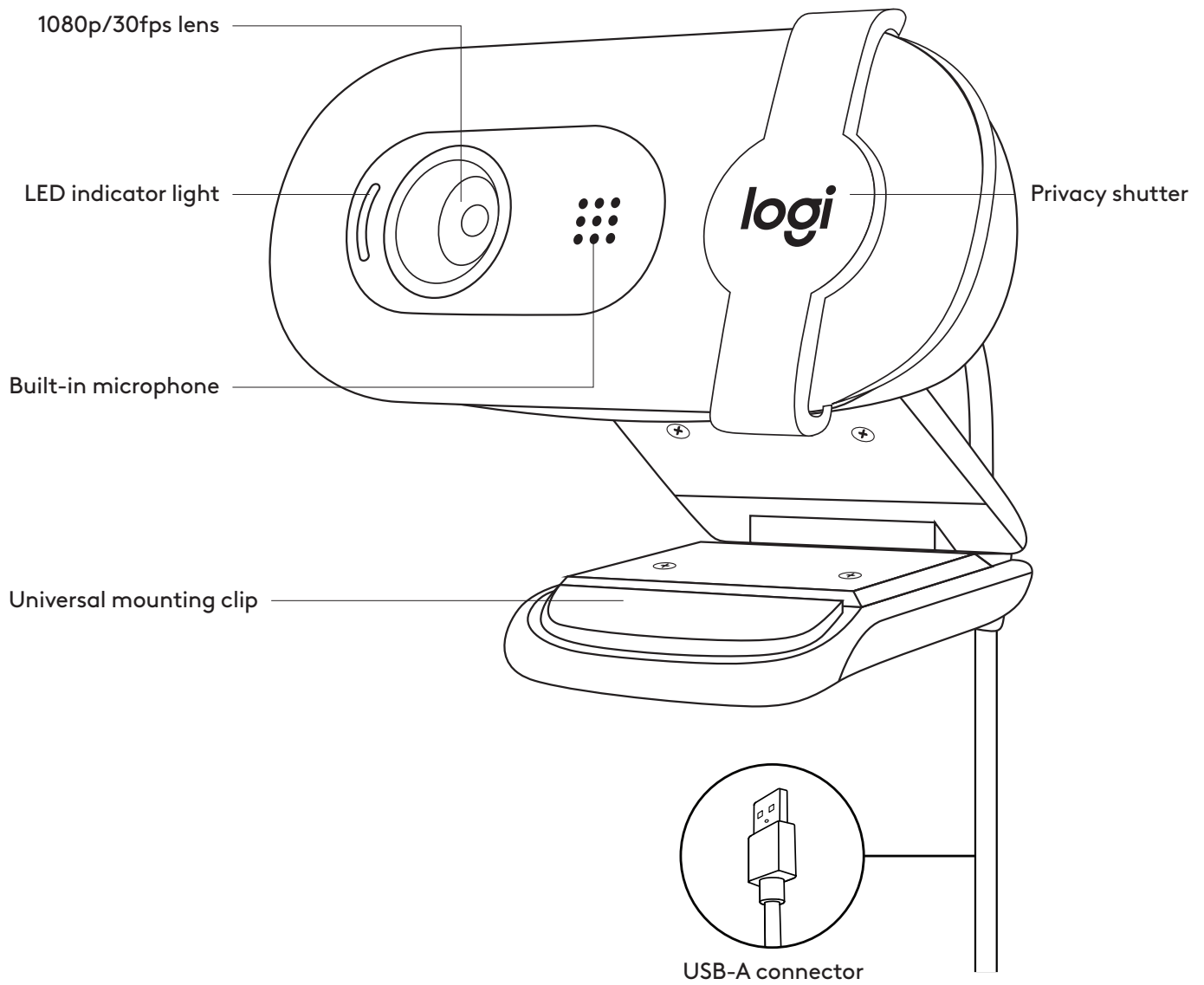

WHAT'S IN THE BOX

- 1 Webcam with 7 ft (2 m) attached USB-A cable
- 2 User documentation

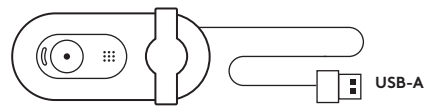

SETTING UP THE WEBCAM

For placement on a monitor

- 1 Place your webcam on a computer, laptop or monitor at a position or angle you desire.

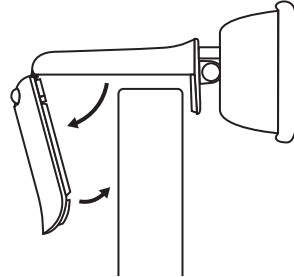

- 2 Adjust the webcam to make sure the end of the universal mounting clip is flush with the back of your device.

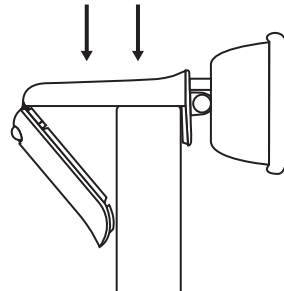

- 3 Manually tilt the webcam up or down to frame yourself within the camera's view.

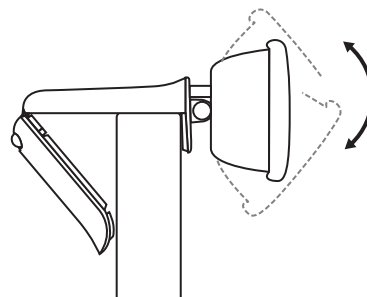

CONNECTING THE WEBCAM VIA USB-A

Plug the USB-A connector into the corresponding port on your computer.

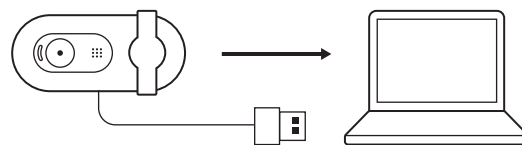

SUCCESSFUL CONNECTION

LED light indicates when the webcam is on and being used by an application.

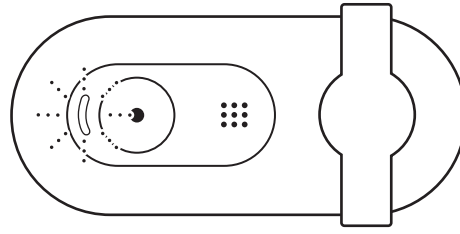

Open the privacy shutter by gently sliding it from left all the way to right. Be sure it does not cover the built-in microphone.

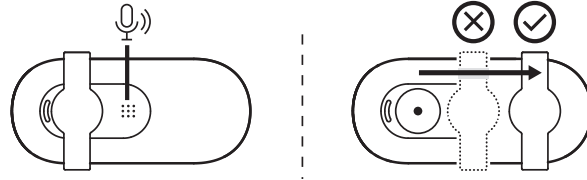

DIMENSIONS

WEBCAM:

Height x Width x Depth:
1.26 in (31.91 mm) x 2.87 in (72.91 mm) x 2.62 in (66.64 mm)

Weight: 2.65 oz (75 g)

www.logitech.com/support/Brio100

PRODUKT AUF EINEN BLICK

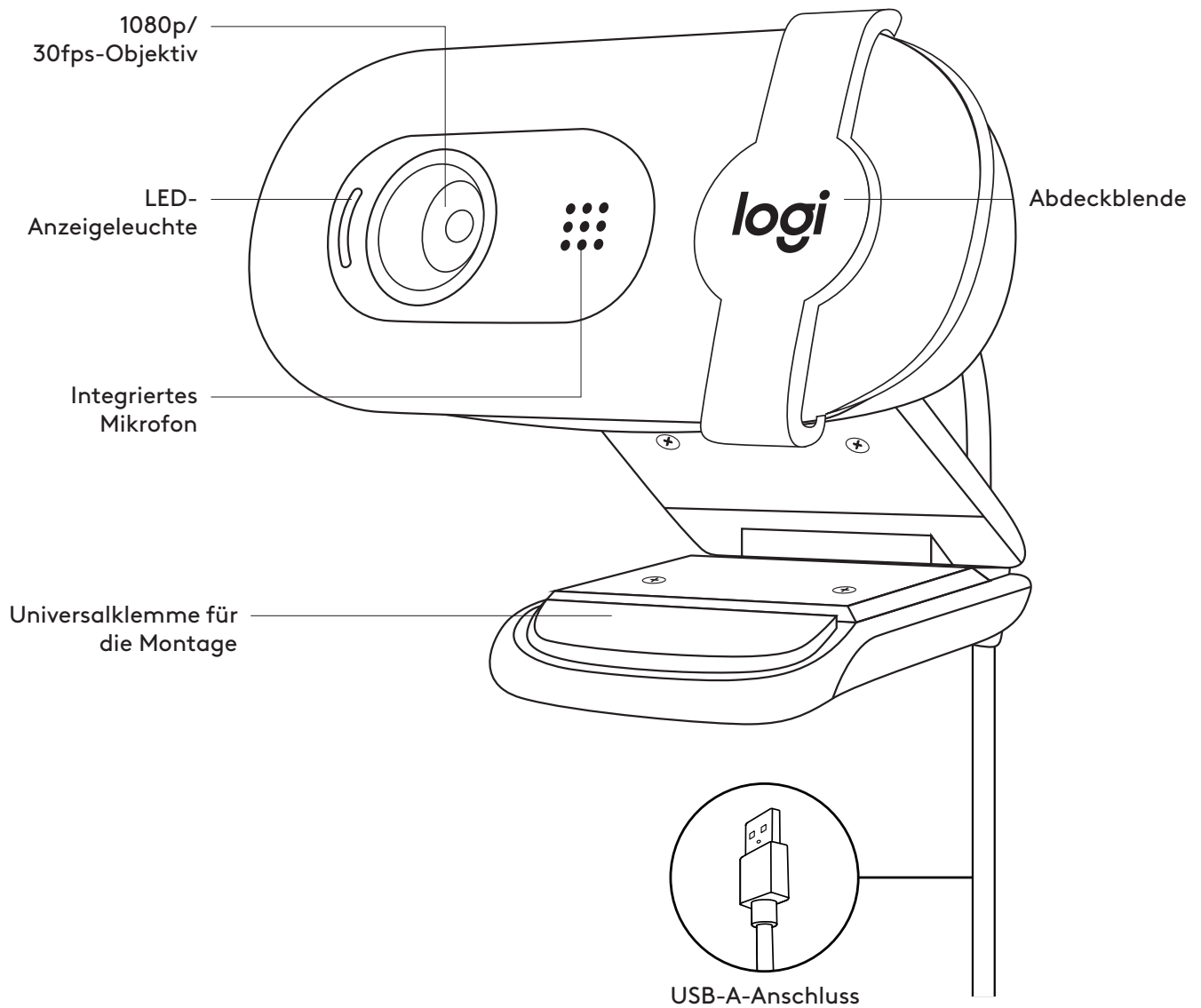

INHALT

- 1 Webcam mit fest angebrachtem USB-A-Kabel (2 m)
- 2 Bedienungsanleitung

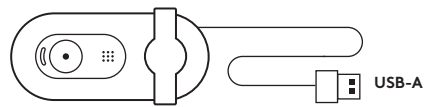

EINRICHTEN DER WEBCAM

Befestigung am Bildschirm

- 1 Die Webcam lässt sich in jeder gewünschten Position und in beliebigem Winkel am Computer, Notebook oder Monitor anbringen.

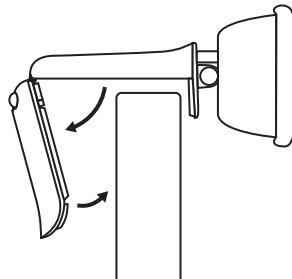

- 2 Positionieren Sie die Webcam so, dass das Ende der Universalklemme bündig mit der Rückseite Ihres Geräts abschließt.

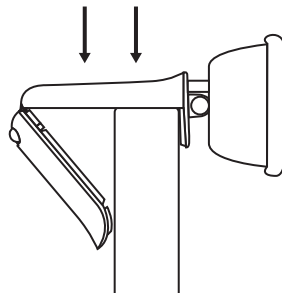

- 3 Kippen Sie die Webcam manuell nach oben oder unten, sodass Sie im Kamerabild gut zu sehen sind.

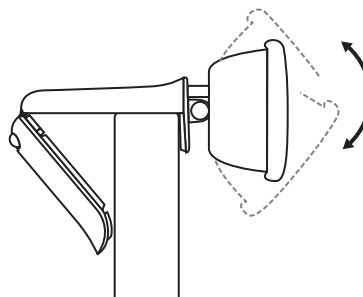

ANSCHLIESSEN DER WEBCAM ÜBER USB-A

Stecken Sie den USB-A-Stecker in den entsprechenden Anschluss an Ihrem Computer.

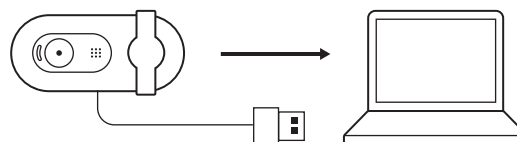

VERBINDUNG ERFOLGREICH

Eine LED-Leuchte zeigt an, wenn die Webcam eingeschaltet ist und von einer Anwendung verwendet wird.

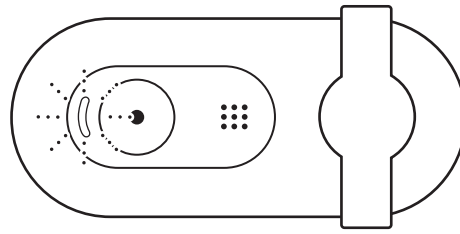

Öffnen Sie die Abdeckblende, indem Sie sie vorsichtig von links ganz nach rechts schieben. Achten Sie darauf, dass sie das integrierte Mikrofon nicht verdeckt.

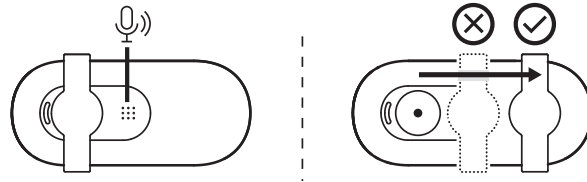

ABMESSUNGEN

WEBCAM:

Höhe x Breite x Tiefe:

31,91 mm (1,26 Zoll) x 72,91 mm (2,87 Zoll) x 66,64 mm (2,62 Zoll)

Gewicht: 75 g (2,65 Unzen)

www.logitech.com/support/Brio100

PRÉSENTATION DU PRODUIT

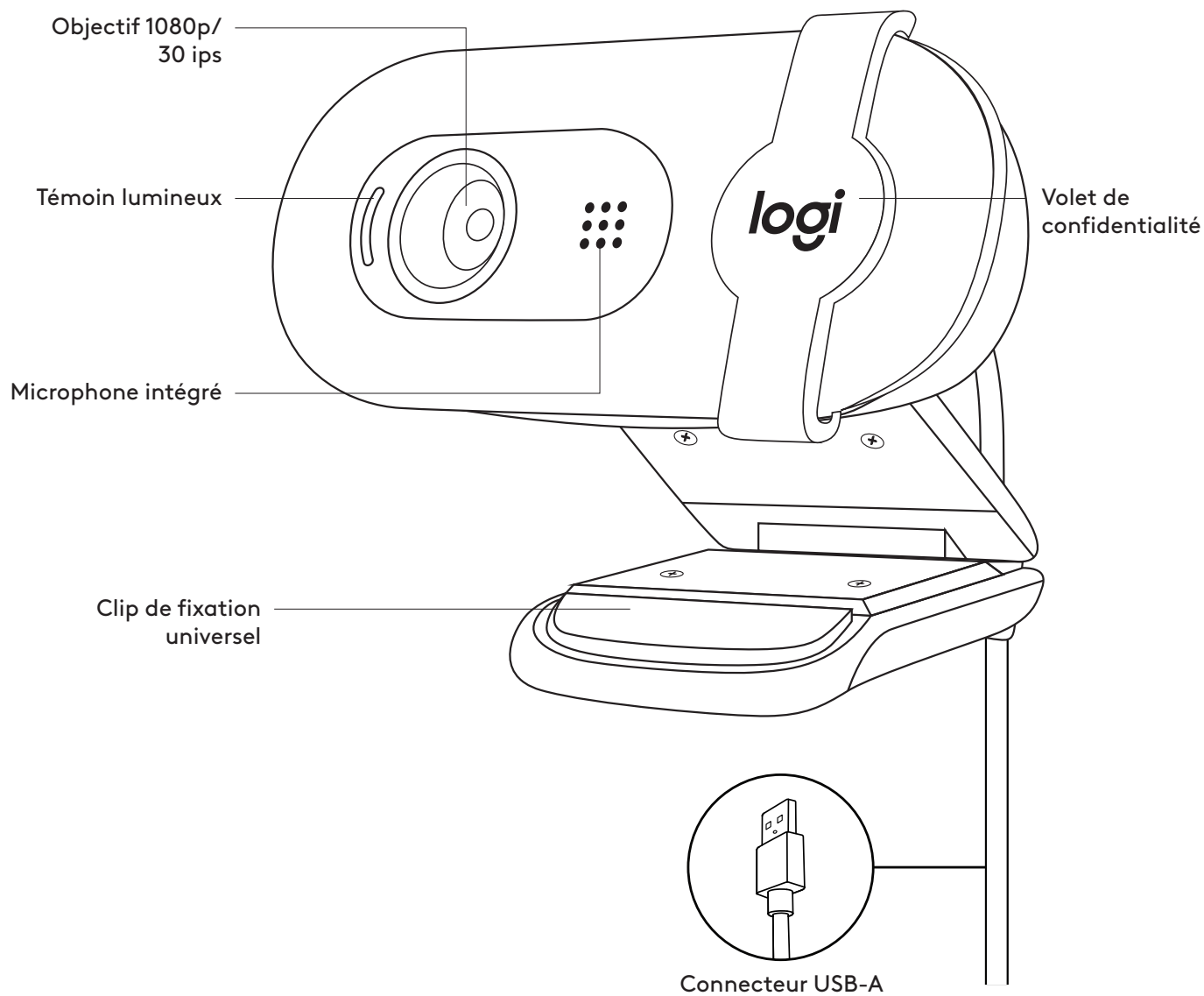

CONTENU DU COFFRET

- 1 Webcam avec câble USB-A de 2 m (7 pieds) fourni
- 2 Documentation utilisateur

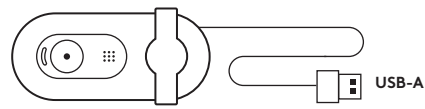

INSTALLATION DE LA WEBCAM

Fixation sur un écran

- 1 Placez votre webcam sur un ordinateur, un ordinateur portable ou un écran à l'angle ou dans la position de votre choix.

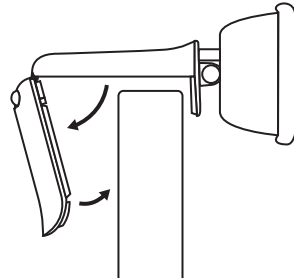

- 2 Ajustez la webcam pour vous assurer que l'extrémité du clip de fixation universel est alignée avec l'arrière de votre dispositif.

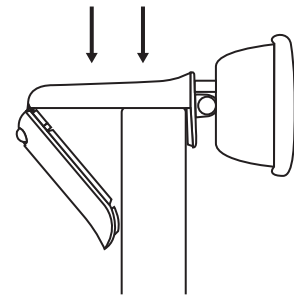

- 3 Inclinez manuellement la webcam vers le haut ou vers le bas pour vous cadrer dans le champ de la caméra.

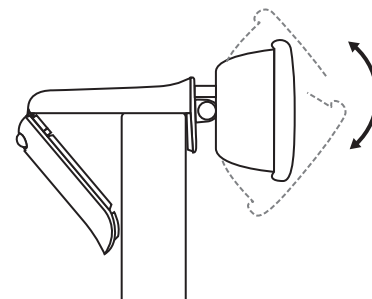

CONNEXION DE LA WEBCAM VIA USB-A

Branchez le connecteur USB-A dans le port correspondant de votre ordinateur.

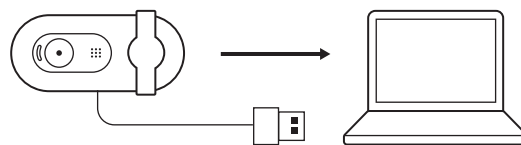

CONNEXION RÉUSSIE

Le témoin lumineux indique lorsque la webcam est activée et utilisée par une application.

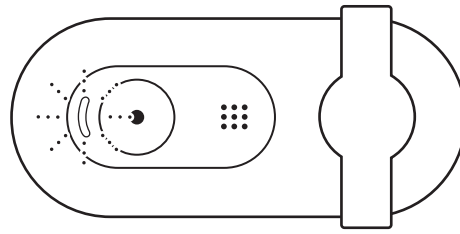

Ouvrez le volet de confidentialité en le faisant glisser doucement de la gauche vers la droite. Veillez à ce qu'il ne recouvre pas le microphone intégré.

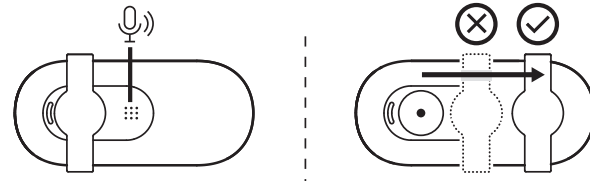

DIMENSIONS

WEBCAM:

Hauteur x largeur x profondeur :

31,91 mm (1,26 pouce) x 72,91 mm (2,87 pouces) x 66,64 mm (2,62 pouces)

Poids: 75 g (2,65 onces)

www.logitech.com/support/Brio100

PANORAMICA DEL PRODOTTO

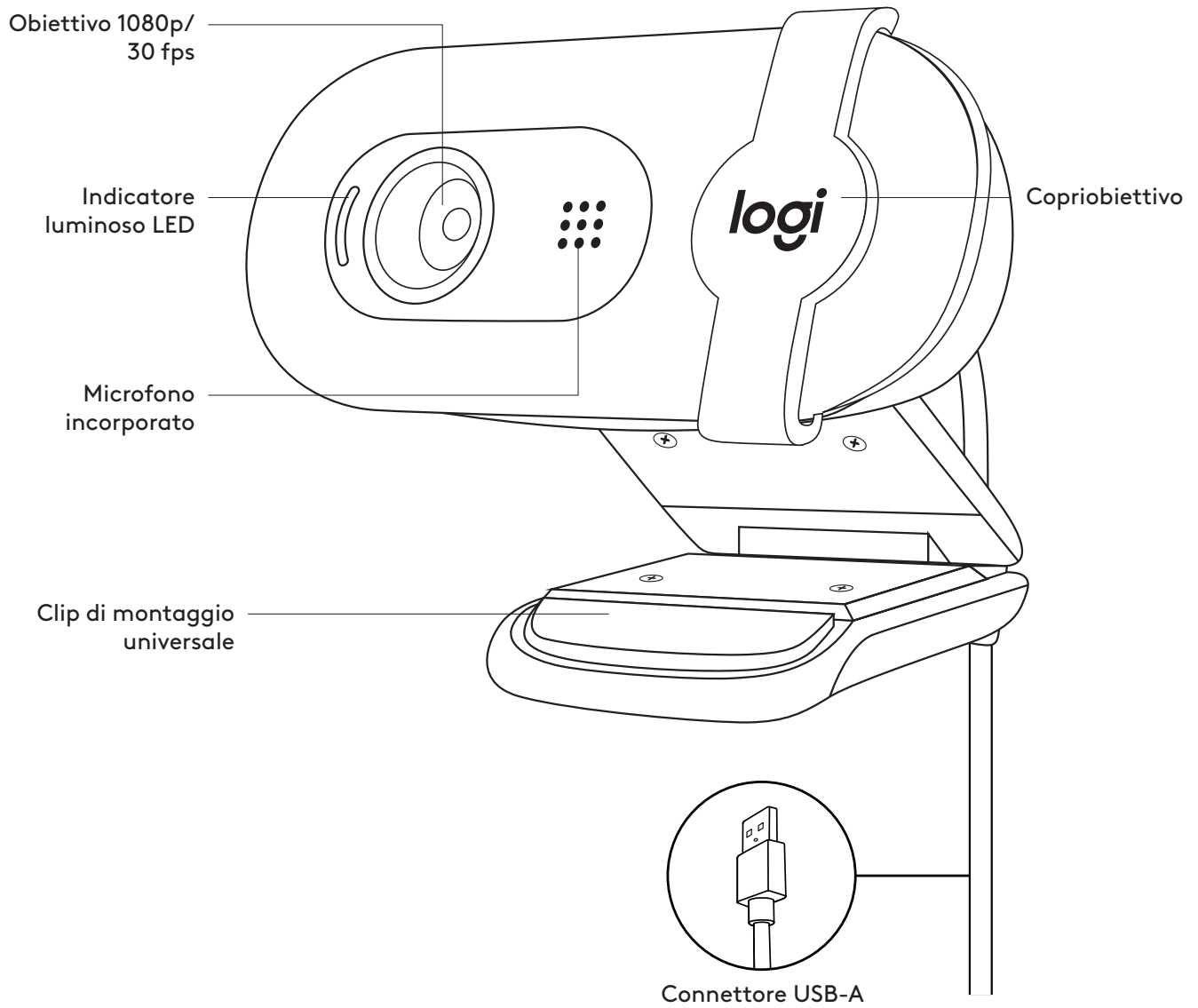

CONTENUTO DELLA CONFEZIONE

- 1 Webcam con cavo USB-A da 2 m collegato
- 2 Documentazione per l'utente

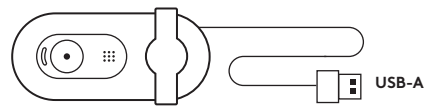

CONFIGURAZIONE DELLA WEBCAM

Posizionamento sul monitor

- 1 Colloca la tua webcam su un computer, laptop o monitor nella posizione o angolazione desiderata.

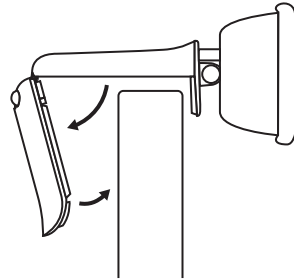

- 2 Regola la webcam per assicurarti che l'estremità della clip di montaggio universale sia allineata con il retro del dispositivo.

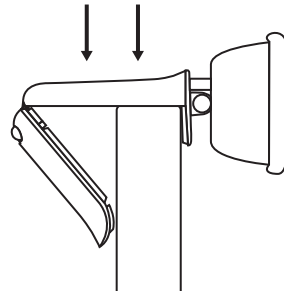

- 3 Inclina manualmente la webcam verso l'alto o verso il basso per inquadrarti nel raggio d'azione della videocamera.

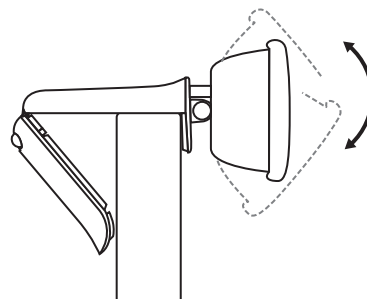

CONNESSIONE DELLA WEBCAM TRAMITE USB-A

Collega il connettore USB-A alla porta corrispondente del computer.

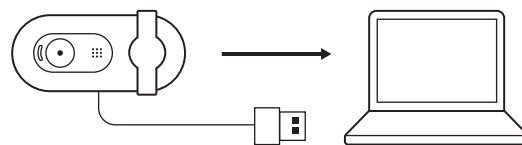

CONNESSIONE RIUSCITA

La spia LED indica quando la webcam è accesa e viene utilizzata da un'applicazione.

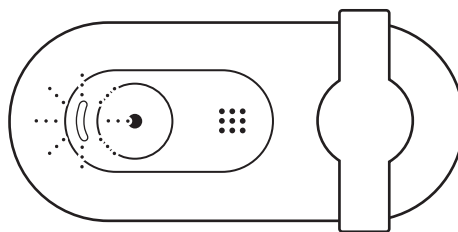

Apri il copriobiettivo facendolo scorrere delicatamente da sinistra verso destra. Accertati che non copra il microfono incorporato.

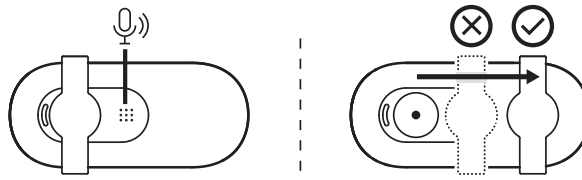

DIMENSIONI

WEBCAM:

Altezza x larghezza x profondità:
31,91 mm (1,26 pollici) x 72,91 mm (2,87 pollici) x 66,64 mm (2,62 pollici)

Peso: 75 g (2,65 once)

www.logitech.com/support/Brio100

COMPONENTES DEL PRODUCTO

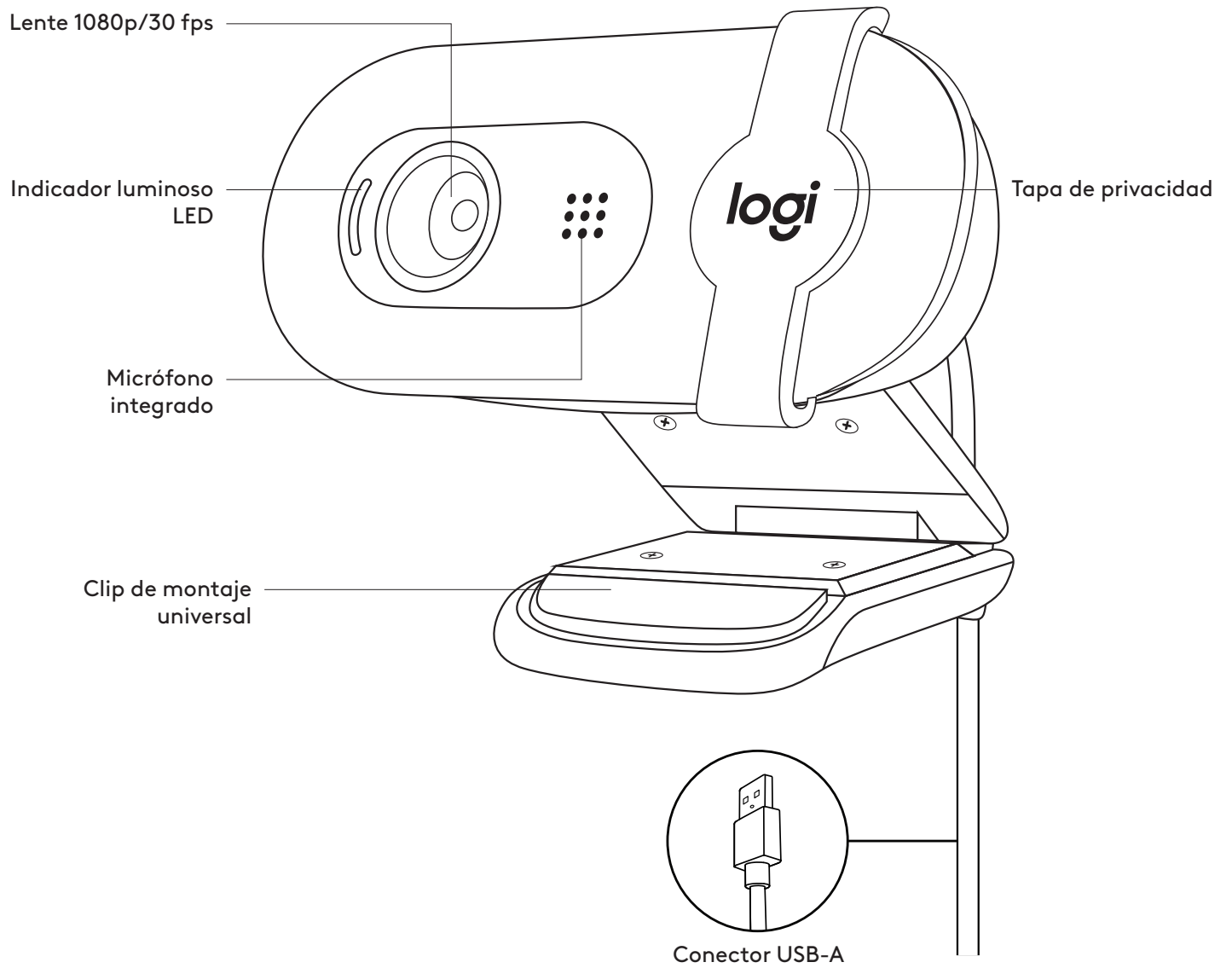

CONTENIDO DE LA CAJA

- 1 Cámara web con cable USB-A fijo de 2 m (7 ft)
- 2 Documentación del usuario

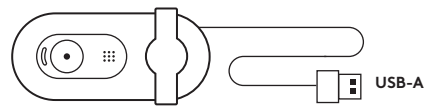

INSTALACIÓN DE LA CÁMARA WEB

Para la colocación en un monitor

- 1 Coloque la cámara web sobre un ordenador de sobremesa, un portátil o un monitor, en la posición o el ángulo que quiera.

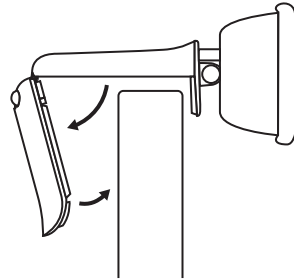

- 2 Ajuste la cámara web de modo que el extremo del clip de montaje universal quede al ras de la parte posterior del dispositivo.

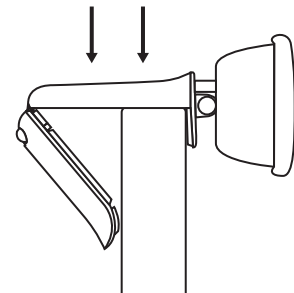

- 3 Incline manualmente la cámara web hacia arriba o hacia abajo para encuadrarse dentro de la vista de la cámara.

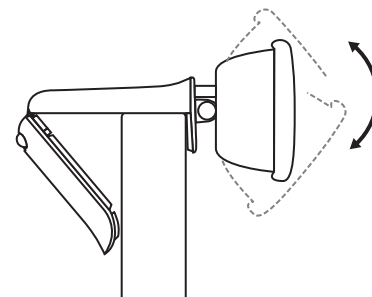

CONEXIÓN DE LA CÁMARA WEB POR USB-A

Inserte el conector USB-A adjunto en el puerto correspondiente del ordenador.

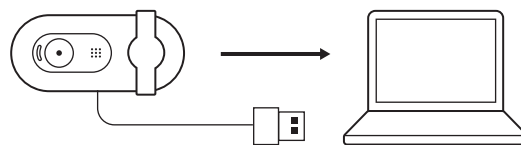

CONEXIÓN REALIZADA CORRECTAMENTE

La luz LED indica cuando la cámara web está encendida y cuando una aplicación la está usando.

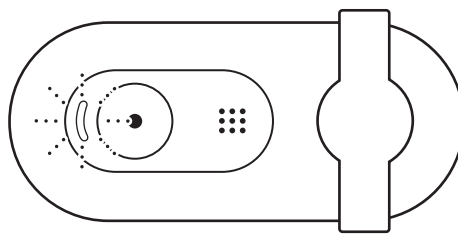

Abra la tapa de privacidad deslizándola suavemente de izquierda a derecha. Asegúrese de que no cubra el micrófono integrado.

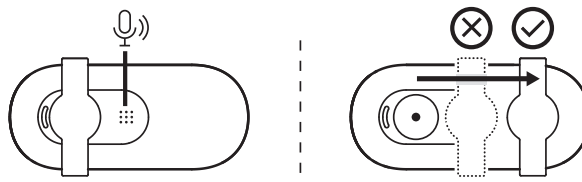

DIMENSIONES

WEBCAM:

Altura x anchura x profundidad:

31,91 mm (1,26 in) x 72,91 mm (2,87 in) x 66,64 mm (2,62 in)

Peso: 75 g (2,65 oz)

www.logitech.com/support/Brio100

CONHEÇA O SEU PRODUTO

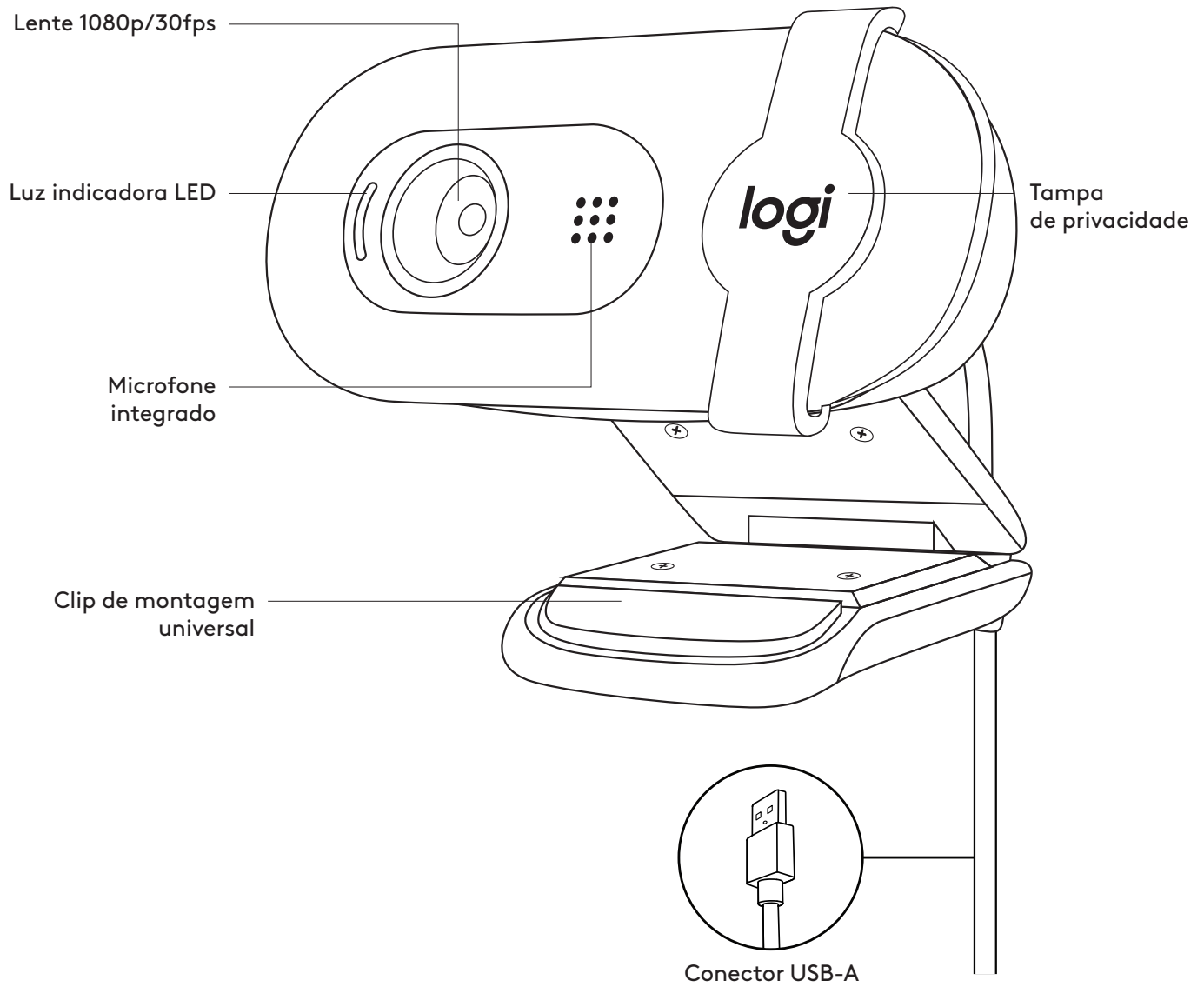

ITENS INCLUÍDOS NA EMBALAGEM

- 1 Câmara Web com cabo USB-A de 2 m
- 2 Documentação do utilizador

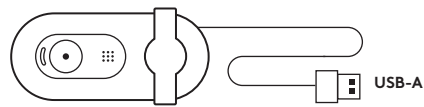

INSTALAR A CÂMARA WEB

Para colocação num monitor

- 1 Coloque a câmara Web num computador, portátil ou monitor na posição e ângulo que desejar.

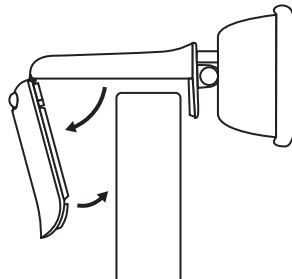

- 2 Ajuste a câmara Web para se certificar de que a base do clip de montagem universal está alinhada com a parte posterior do seu dispositivo.

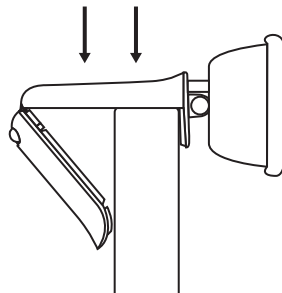

- 3 Incline a câmara Web manualmente para cima ou para baixo para se enquadrar na imagem da câmara.

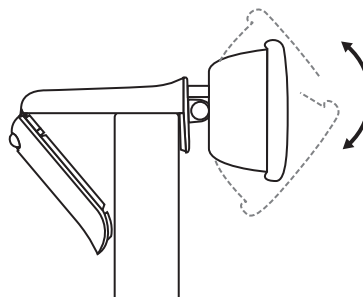

LIGAR A CÂMARA WEB POR USB-A

Ligue o conector USB-A à porta correspondente no seu computador.

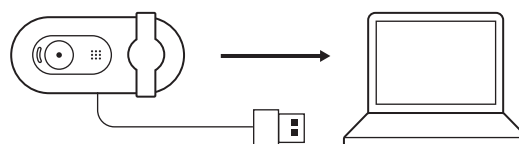

LIGAÇÃO COM ÊXITO

A luz LED indica quando a câmara Web está ligada e a ser utilizada por uma aplicação.

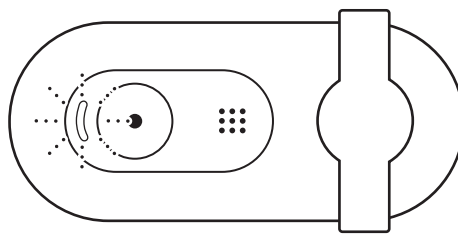

Abra a tampa de privacidade deslizando-a suavemente da esquerda para a direita. Certifique-se de que não cobre o microfone integrado.

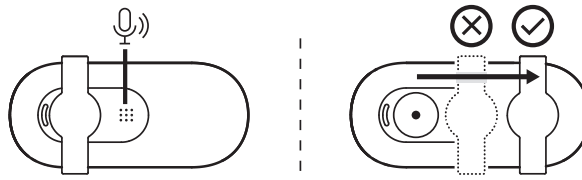

DIMENSÕES

CÂMARA WEB:

Altura x largura x profundidade:
31,91 mm x 72,91 mm x 66,64 mm

Peso: 75 g

www.logitech.com/support/Brio100

KEN UW PRODUCT

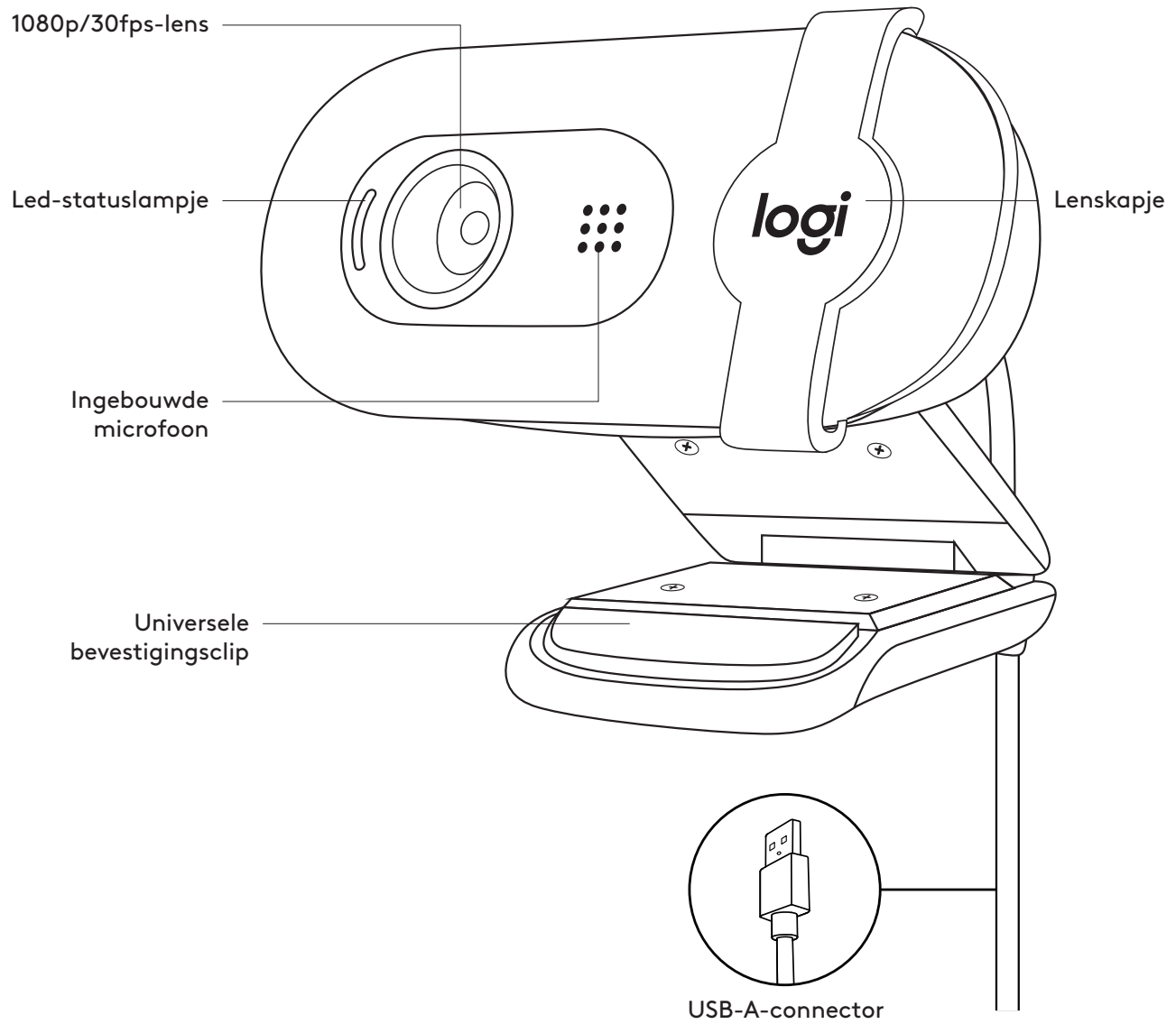

INHOUD VAN DE DOOS

- 1 Webcam met aangesloten USB-A-kabel van 2 m (7 ft)
- 2 Handleiding

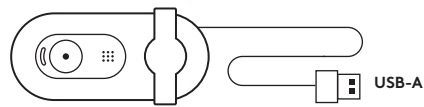

DE WEBCAM OPZETTEN

Voor bevestiging op een monitor

- 1 Plaats de webcam op een computer, laptop of beeldscherm in een positie of hoek naar keuze.

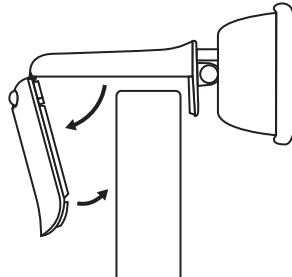

- 2 Plaats de webcam zo dat het uiteinde van de universele bevestigingsclip is uitgelijnd met de achterkant van het apparaat.

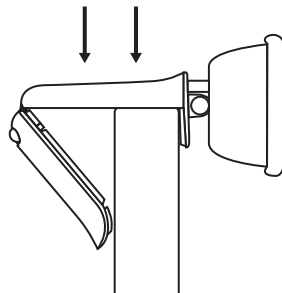

- 3 Kantel de webcam handmatig omhoog of omlaag om uzelf in het zicht van de camera te plaatsen.

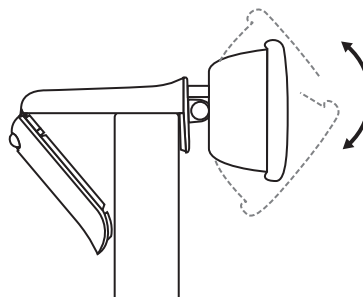

DE WEBCAM VIA USB-A AANSLUITEN

Steek de USB-A-connector in de overeenkomstige poort op uw computer.

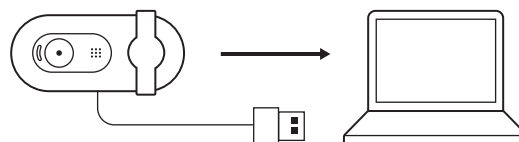

GESLAAGDE VERBINDING

Het led-lampje geeft aan wanneer de webcam is ingeschakeld en door een toepassing wordt gebruikt.

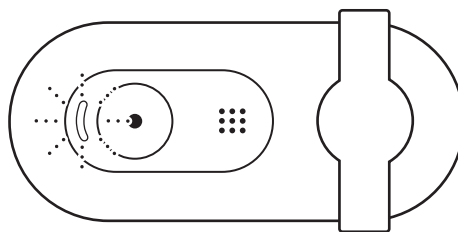

Open het lenskapje door het voorzichtig van links helemaal naar rechts te schuiven. Zorg ervoor dat het de ingebouwde microfoon niet afdekt.

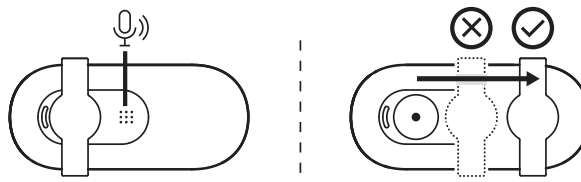

AFMETINGEN

WEBCAM:

Hoogte x breedte x diepte:
31,91 x 72,91 x 66,64 mm (1,26 x 2,87 x 2,62 in)

Gewicht: 75 g (2,65 oz)

www.logitech.com/support/Brio100

PRODUKTÖVERSIKT

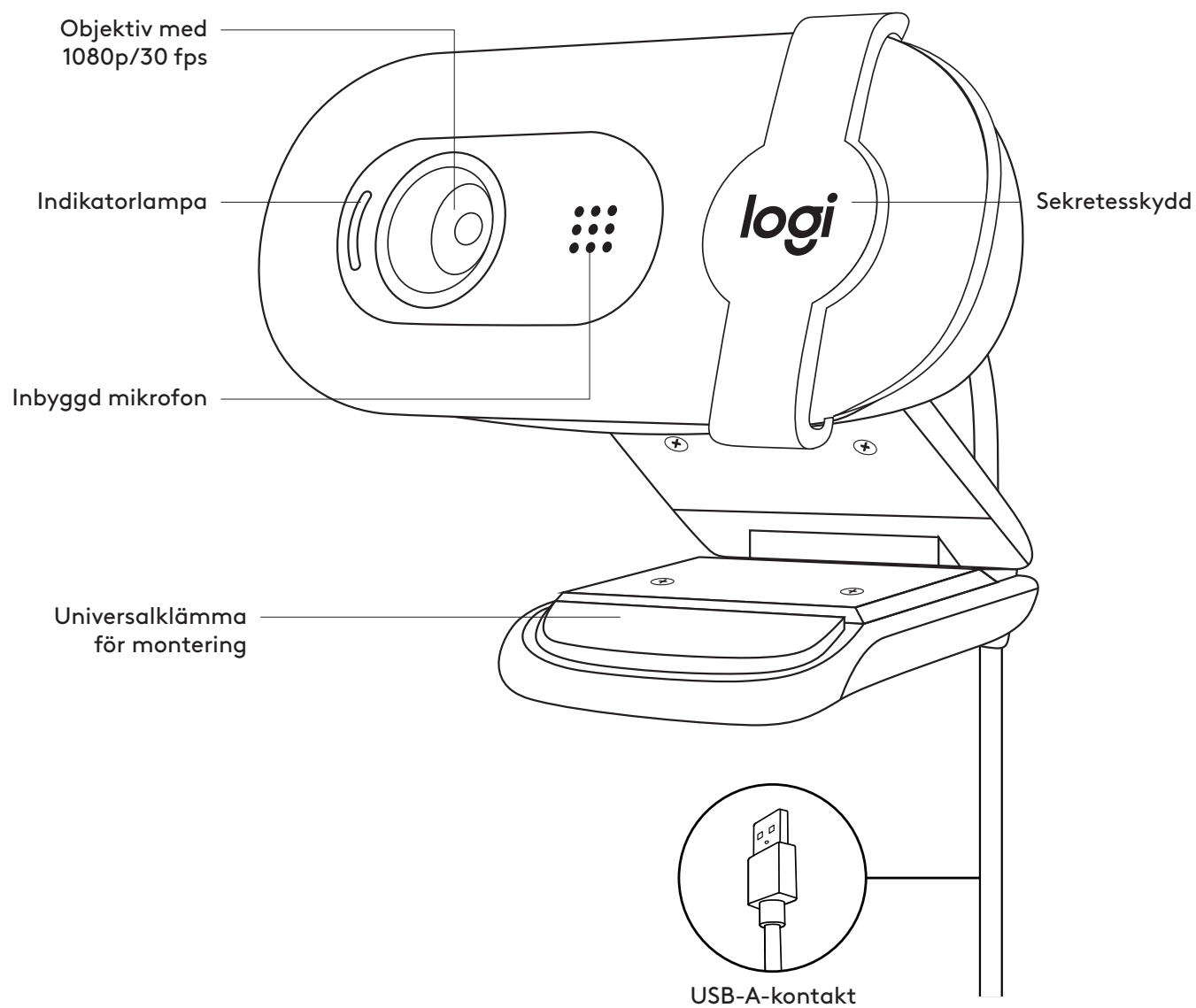

INNEHÅLL

- 1 Webbkamera med 2 m USB-A-sladd
- 2 Bruksanvisning

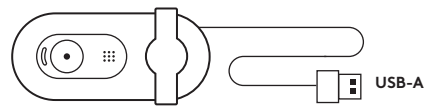

STÄLLA IN WEBBKAMERA

Placera på en skärm

- 1 Placera webbkameran på en stationär eller bärbar dator eller skärm i önskad position eller vinkel.

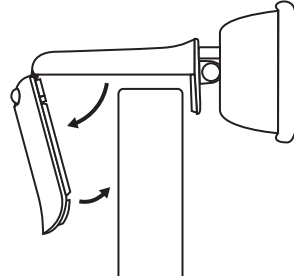

- 2 Justera webbkameran för att se till att änden på den universella monteringsklämman är i linje med baksidan av enheten.

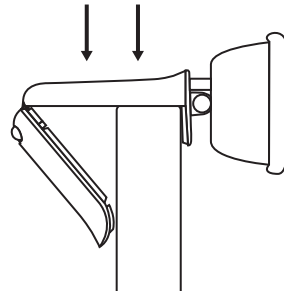

- 3 Luta webbkameran manuellt uppåt eller nedåt så att du hamnar i kamerans vy.

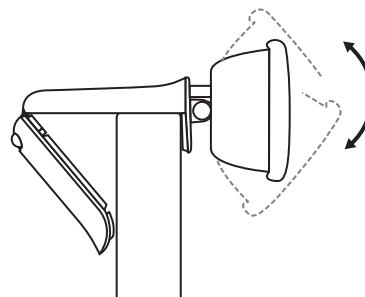

ANSLUTA WEBBKAMERAN VIA USB-A-SLADD

Anslut USB-A-kontakten till motsvarande port på datorn.

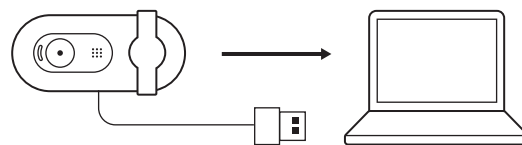

ANSLUTNING

Indikatorlampan visar när webbkameran är på och används av en applikation.

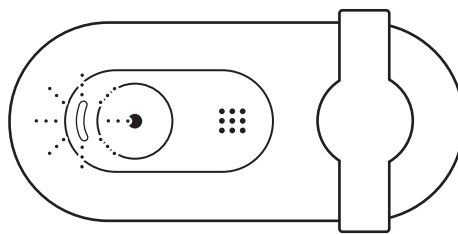

Öppna sekretesskyddet genom att dra det mjukt från vänster och hela vägen till höger. Se till att det inte täcker den inbyggda mikrofonen.

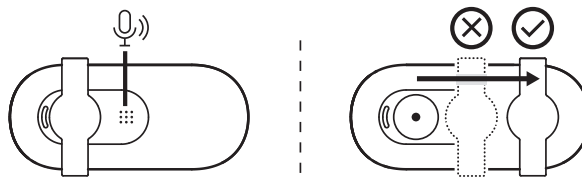

MÅTT

WEBBKAMERA:

Höjd x bredd x djup:

31,91 mm (1,26 tum) x 72,91 mm (2,87 tum) x 66,64 mm (2,62 tum)

Vikt: 75 g (2,65 uns)

www.logitech.com/support/Brio100

OVERSIGT OVER PRODUKTET

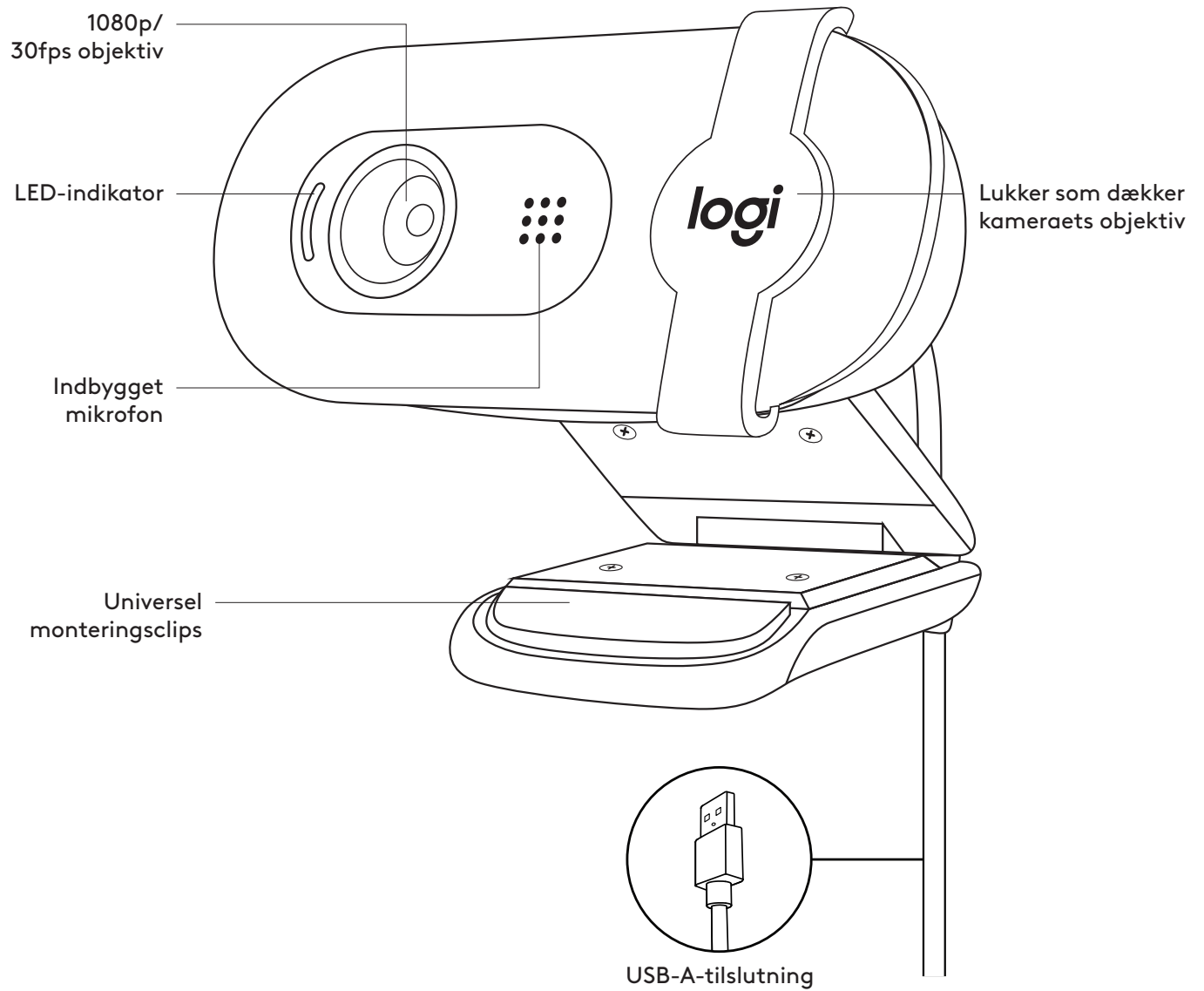

KASSEN INDEHOLDER

- 1 Webkamera med 2 m (7 ft) medfølgende USB-A-kabel
- 2 Brugervejledning

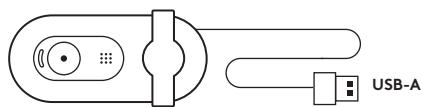

OPSÆTNING AF WEBKAMERAET

Ved montering på en skærm

- 1 Placer webkameraet på en computer, en bærbar eller en skærm på en måde og i en vinkel, som passer.

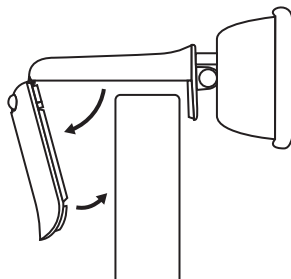

- 2 Juster webkameraet så endestykket for den universelle monteringsclips flugter med bagsiden af din enhed.

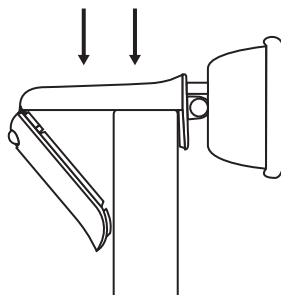

- 3 Vip webkameraet op eller ned manuelt for at indramme dig selv inden for kameraets visning.

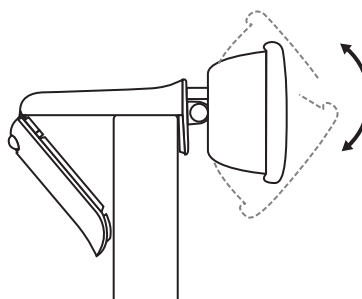

TILSLUTNING AF WEBKAMERAET VIA USB-A

Tilslut USB-A-stikket til den tilsvarende port på din computer.

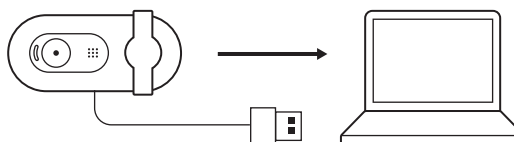

TILSLUTNING

LED-lys indikerer, når webkameraet er tændt og bruges af et program.

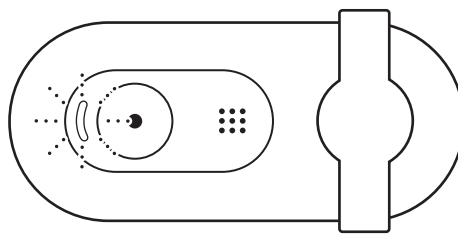

Åbn lukkeren ved at skubbe den forsigtigt fra venstre og helt mod højre. Sørg for, at den ikke dækker den indbyggede mikrofon.

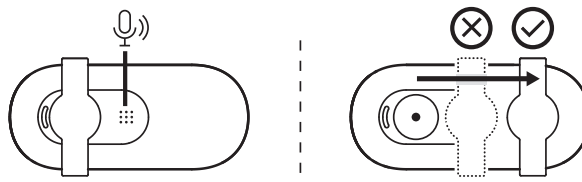

MÅL

WEBKAMERA:

Højde x bredde x dybde:

31,91 mm (1,26") x 72,91 mm (2,87") x 66,64 mm (2,62")

Vægt: 75 g

www.logitech.com/support/Brio100

BLI KJENT MED PRODUKTET

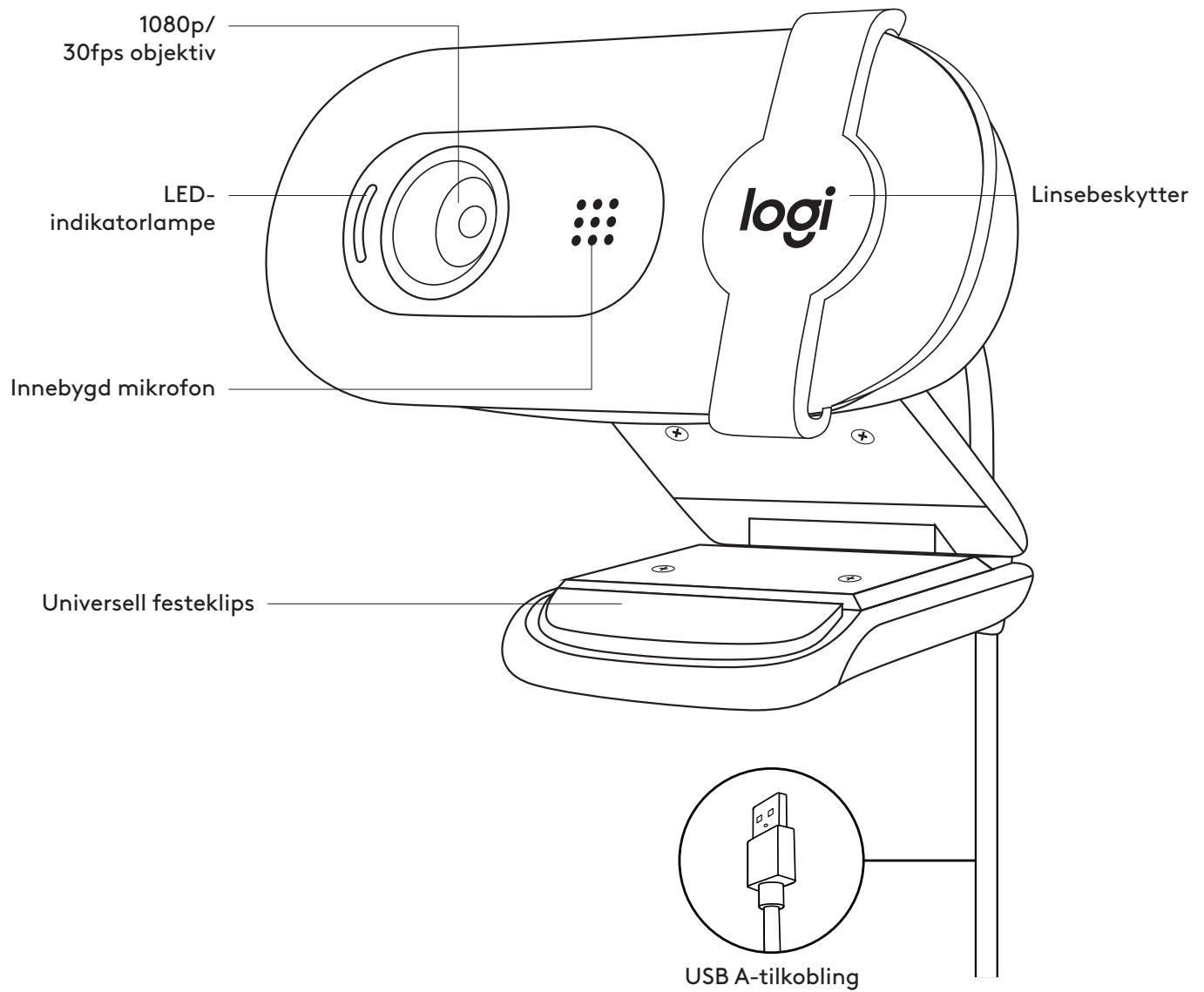

HVA ER I ESKEN

- 1 Webkamera med 2 m USB-A-kabel vedlagt
- 2 Brukerdokumentasjon

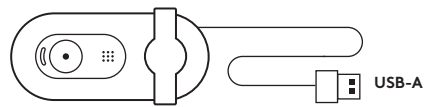

SETTE OPP WEBKAMERAET

På datamaskinskjermen

- 1 Plasser webkameraet på en datamaskin, bærbar datamaskin eller skjerm i ønsket posisjon eller vinkel.
- 2 Juster webkameraet for å forsikre deg om at kanten på den universelle festeklipsen er i flukt med baksiden av enheten.

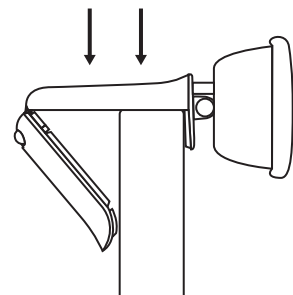
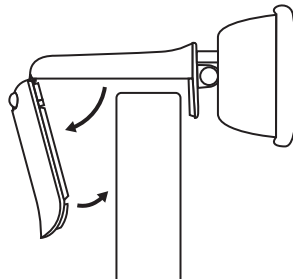

- 3 Vipp webkameraet opp eller ned manuelt for å filme deg selv i kameravisningen.

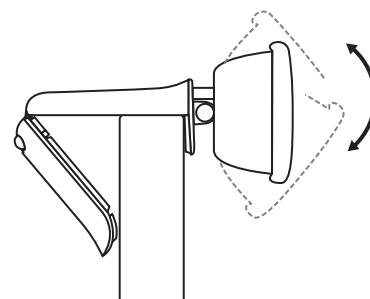

KOBLE TIL WEBKAMERAET VIA USB-A

Koble USB-A-kontakten til den tilsvarende porten på datamaskinen.

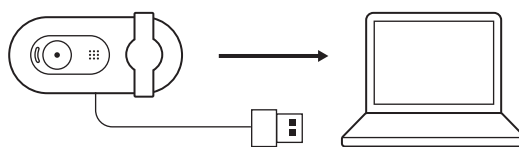

TILKOBLING FULLFØRT

En LED-indikatorlampe angir når webkameraet er på og brukes av et program.

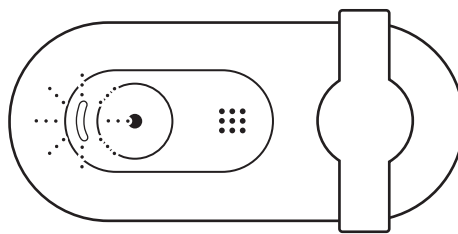

Åpne linsebeskytteren ved å skyve den forsiktig fra venstre og helt til høyre. Pass på at den ikke dekker den innebygde mikrofonen.

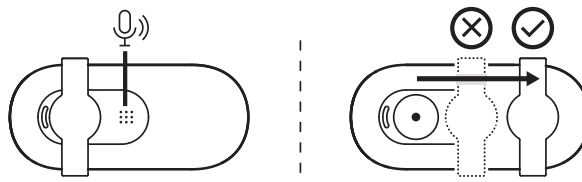

DIMENSJONER

WEBKAMERA:

Høyde x bredde x dybde:
31,91 x 72,91 x 66,64 cm

Vekt: 75 g

www.logitech.com/support/Brio100

TUNNE TUOTTEESI

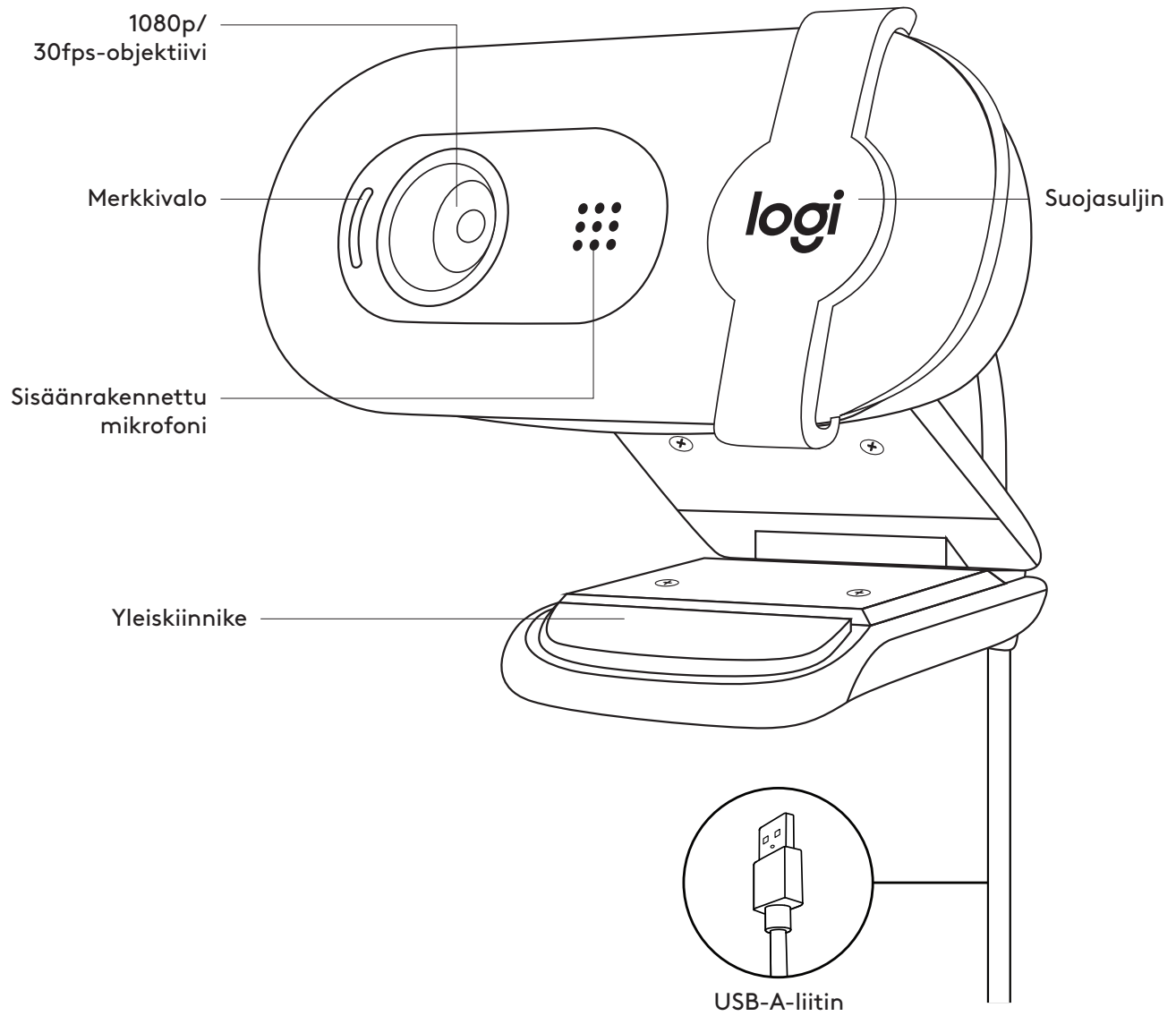

PAKKAUKSEN SISÄLTÖ

- 1 Verkkokamera ja 2 metrin kiinteä USB-A-johto
- 2 Käyttäjän dokumentaatio

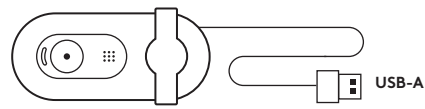

VERKKOKAMERAN KÄYTTÖÖNOTTO

Näytön päälle sijoittaminen

- 1 Aseta verkkokamera tietokoneen, kannettavan tai näytön päälle valitsemaasi asentoon tai kulmaan.

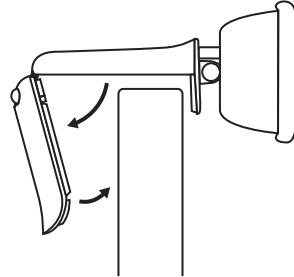

- 2 Säädä verkkokameraa niin, että yleiskiinnikkeen pää on tukevasti kiinni laitteen takaosassa.

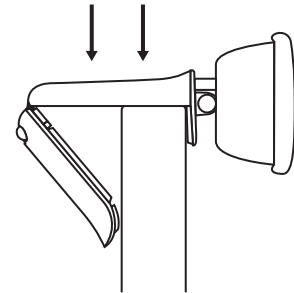

- 3 Kallista verkkokameraa manuaalisesti ylös- tai alaspäin rajataksesi itsesi kameran kuvaan.

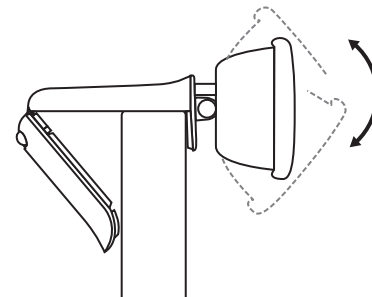

VERKKOKAMERAN LIITTÄMINEN USB-A-JOHDOLLA

Liitä USB-A-liitin tietokoneen vastaavaan porttiin.

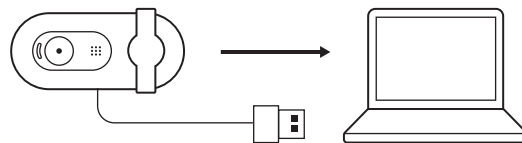

YHTEYS ON MUODOSTETTU

LED-valo ilmaisee, kun verkkokamera on päällä ja sovellus käyttää sitä.

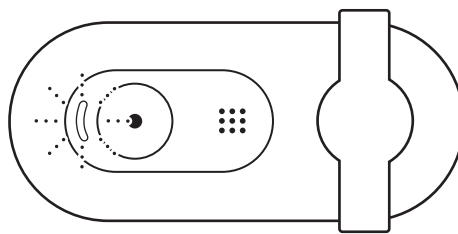

Avaa suojasuljin liu'uttamalla se varovasti vasemmalta oikealle. Varmista, että se ei peitä kiinteää mikrofonia.

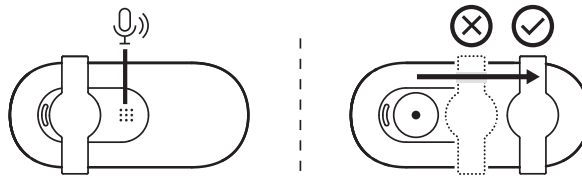

MITAT

VERKKOKAMERA:

Korkeus × leveys × syvyys:
31,91 × 72,91 × 66,64 mm

Paino: 75 g

www.logitech.com/support/Brio100

ΓΝΩΡΙΜΙΑ ΜΕ ΤΟ ΠΡΟΪΟΝ

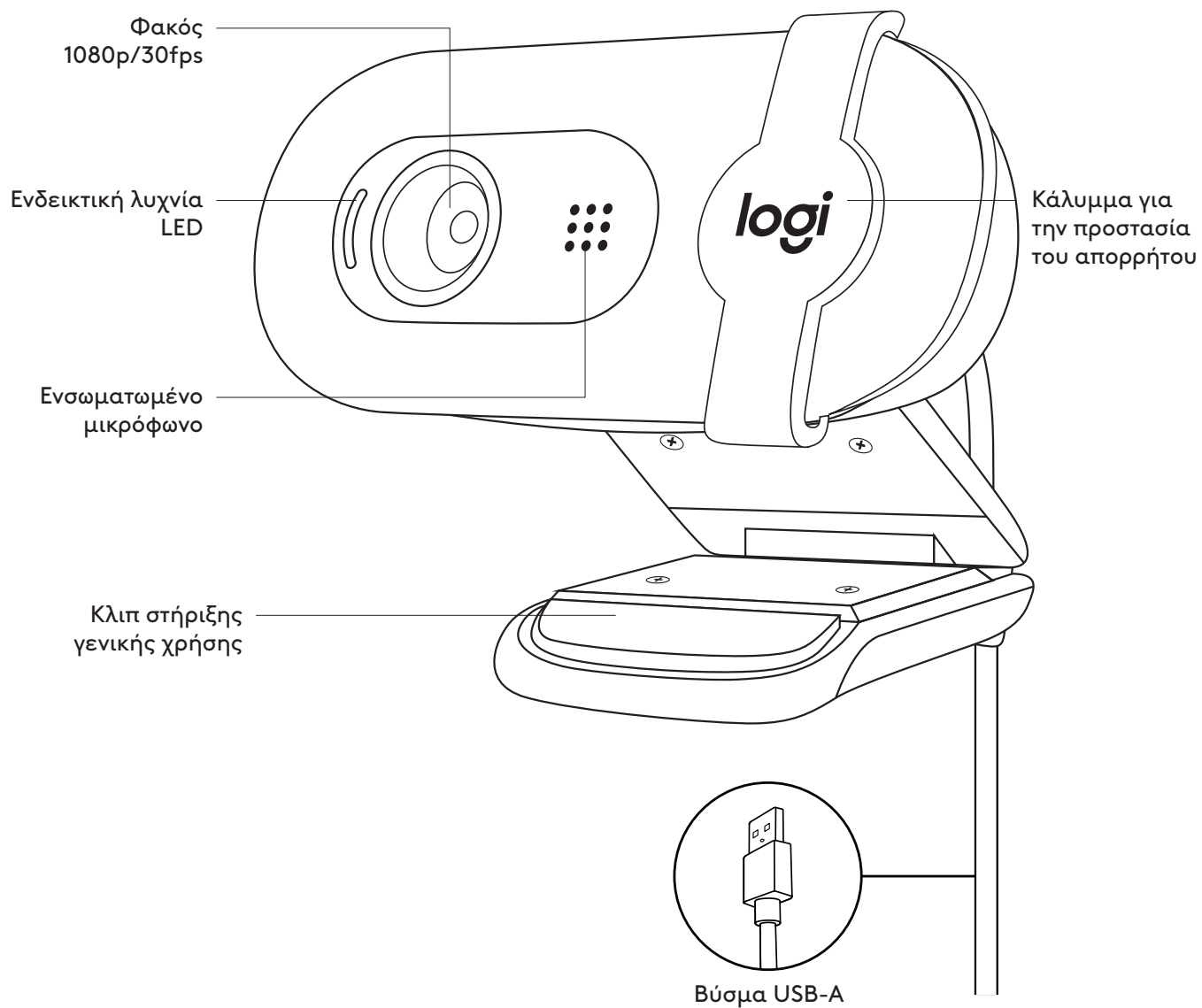

ΠΕΡΙΕΧΟΜΕΝΑ ΣΥΣΚΕΥΑΣΙΑΣ

- 1 Webcam με ενσωματωμένο καλώδιο USB-A 2 m (7 ft)
- 2 Εγχειρίδιο χρήστη

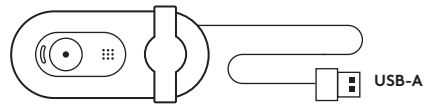

ΡΥΘΜΙΣΗ ΤΗΣ WEBCAM

Για τοποθέτηση σε οθόνη

- 1 Τοποθετήστε τη webcam σε έναν υπολογιστή, φορητό υπολογιστή ή οθόνη στη θέση ή τη γωνία που επιθυμείτε.

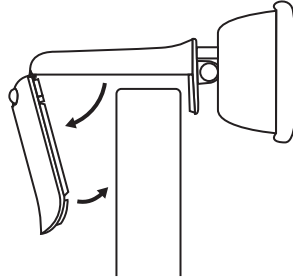

- 2 Ρυθμίστε τη webcam για να βεβαιωθείτε ότι το άκρο του κλιπ στήριξης γενικής χρήσης είναι ευθυγραμμισμένο με το πίσω μέρος της συσκευής σας.

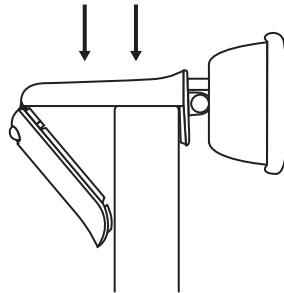

- 3 Δώστε κλίση στη webcam προς τα επάνω ή προς τα κάτω για να φαίνεστε στο κάδρο της κάμερας.

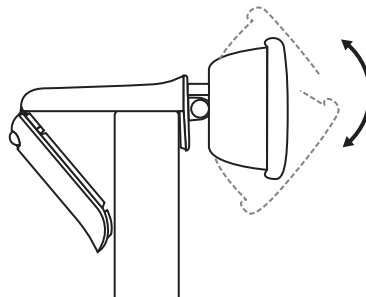

ΣΥΝΔΕΣΗ ΤΗΣ WEBCAM ΜΕΣΩ USB-A

Συνδέστε το βύσμα USB-A στην αντίστοιχη θύρα του υπολογιστή σας.

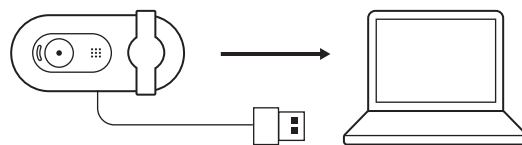

ΕΠΙΤΥΧΗΣ ΣΥΝΔΕΣΗ

Η ενδεικτική λυχνία LED δείχνει πότε η webcam είναι ενεργή και χρησιμοποιείται από μια εφαρμογή.

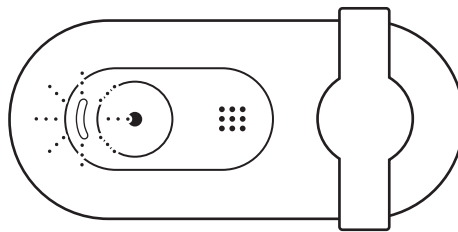

Ανοίξτε το κάλυμμα για την προστασία του απορρήτου σύροντάς το απαλά από την αριστερή προς τη δεξιά πλευρά. Βεβαιωθείτε ότι δεν καλύπτει το ενσωματωμένο μικρόφωνο.

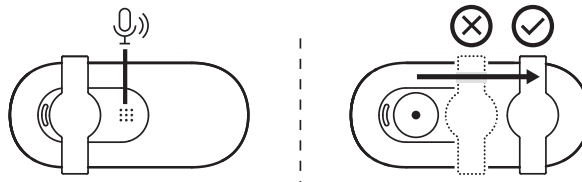

ΔΙΑΣΤΑΣΕΙΣ

WEBCAM:

Ύψος x Πλάτος x Βάθος:

31,91 mm (1,26 in) x 72,91 mm (2,87 in) x 66,64 mm (2,62 in)

Βάρος: 75 g (2,65 oz)

www.logitech.com/support/Brio100

ЗНАКОМСТВО С ПРОДУКТОМ

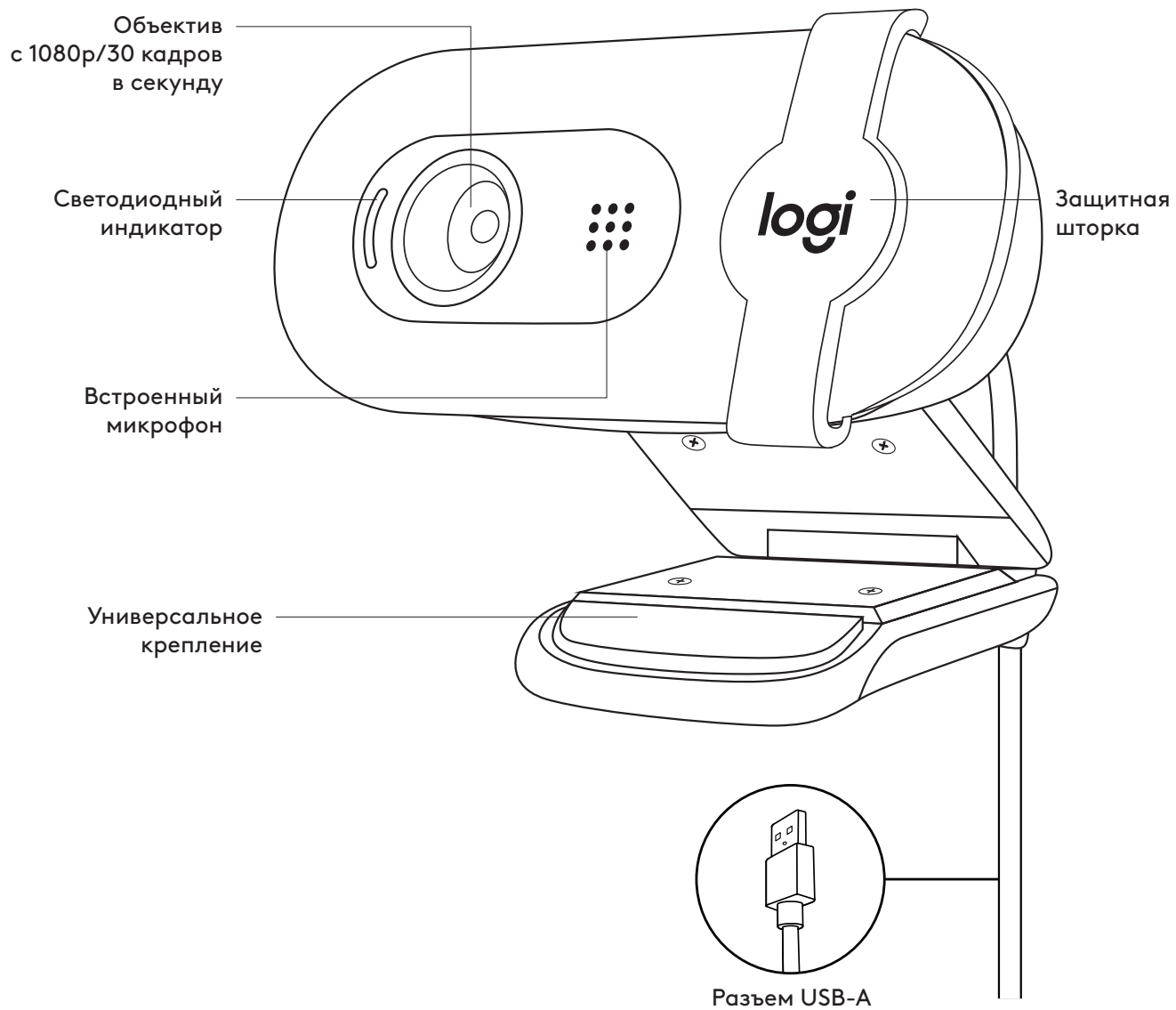

КОМПЛЕКТ ПОСТАВКИ

- 1 Веб-камера с прикрепленным кабелем USB-A длиной 2 м
- 2 Документация пользователя

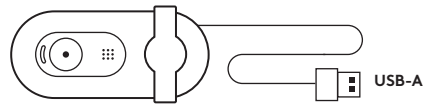

ПОДГОТОВКА ВЕБ-КАМЕРЫ К РАБОТЕ

Размещение на мониторе

- 1 Установите веб-камеру на компьютер, ноутбук или монитор в нужном положении и под нужным углом.

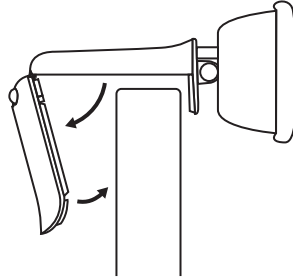

- 2 Отрегулируйте положение веб-камеры так, чтобы торец универсального крепления прилегал к задней панели устройства.

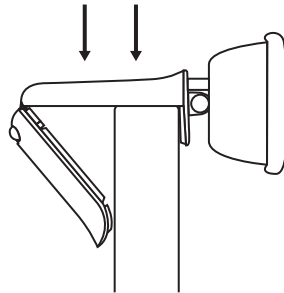

- 3 Изменяйте наклон камеры вручную, чтобы отрегулировать кадр.

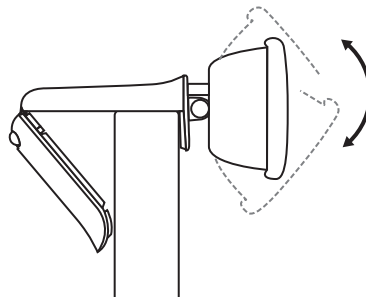

ПОДКЛЮЧЕНИЕ ВЕБ-КАМЕРЫ ЧЕРЕЗ РАЗЪЕМ USB-A

Подключите разъем USB-A к соответствующему порту компьютера.

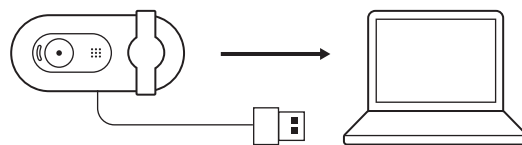

УСПЕШНОЕ ПОДКЛЮЧЕНИЕ

Светодиодный индикатор сигнализирует о том, что веб-камера включена и используется приложением.

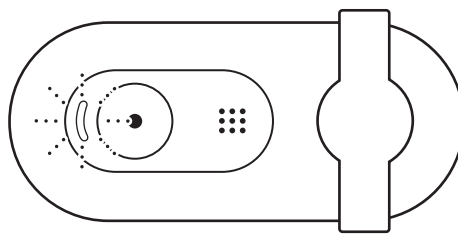

Откройте защитную шторку, аккуратно передвинув ее слева направо. Убедитесь, что она не перекрывает встроенный микрофон.

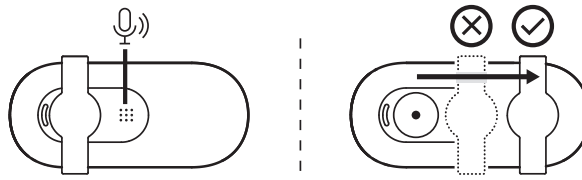

РАЗМЕРЫ

ВЕБ-КАМЕРА

Высота x ширина x длина:
31,91 мм x 72,91 мм x 66,64 мм

Вес: 75 г

www.logitech.com/support/Brio100

OPIS URZĄDZENIA

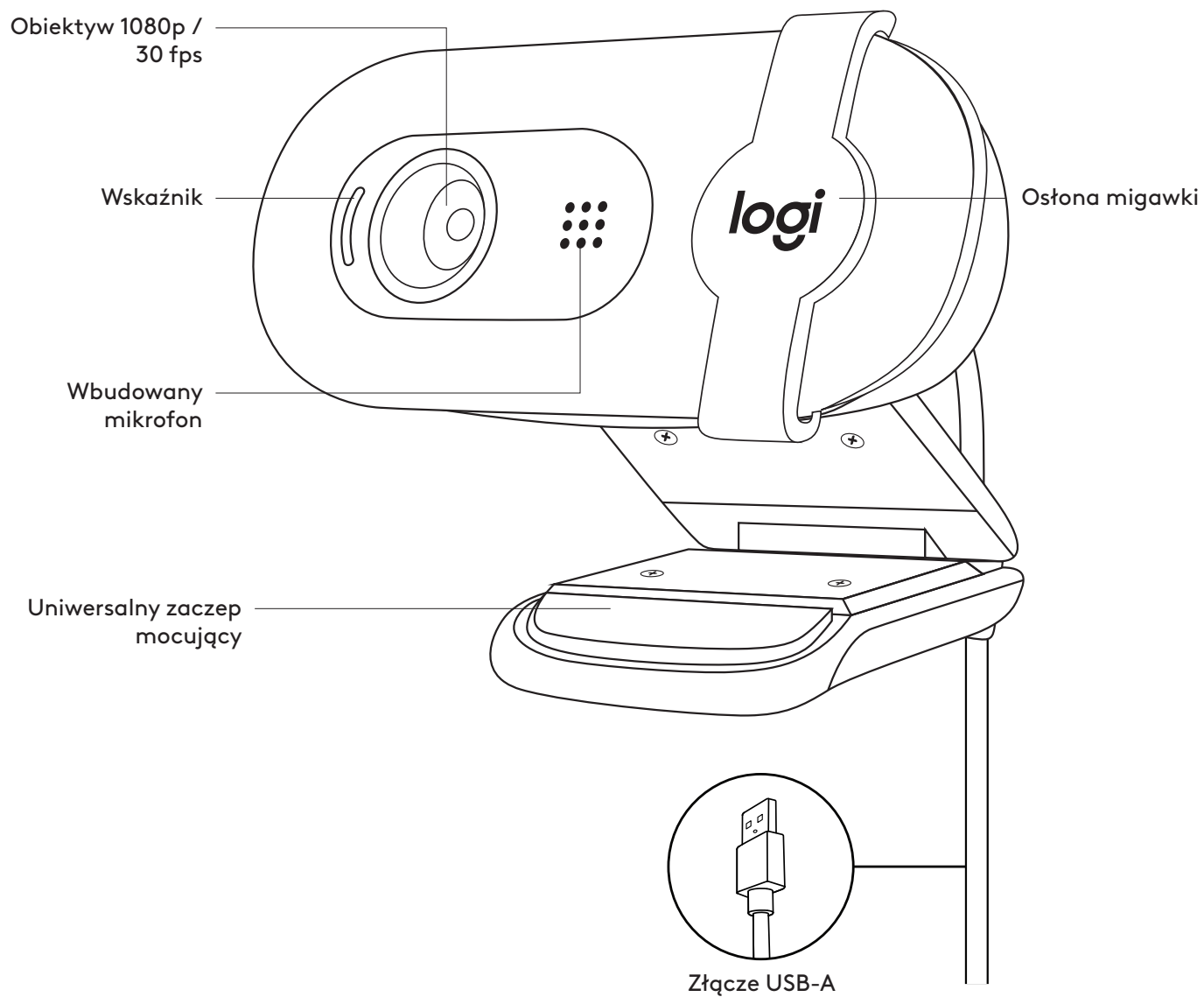

ZAWARTOŚĆ OPAKOWANIA

- 1 Kamera internetowa z dołączonym kablem USB-A o długości 2 m
- 2 Dokumentacja produktu

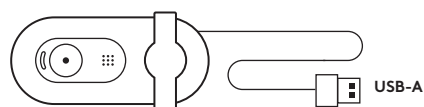

PRZYGOTOWYWANIE KAMERY INTERNETOWEJ

W celu umieszczenia na monitorze

- 1 Umieść kamerę internetową na komputerze, laptopie lub monitorze pod kątem, który Ci odpowiada.

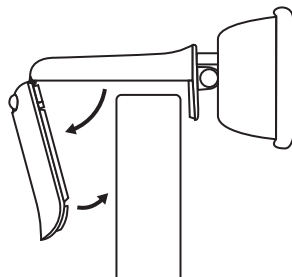

- 2 Dostosuj kamerę internetową, aby upewnić się, że końcówka na uniwersalnym zaczepie mocującym znajduje się na równi z tylną częścią urządzenia.

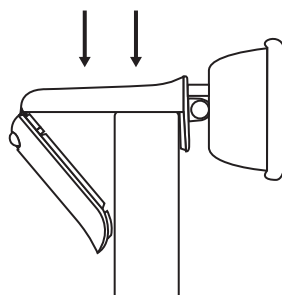

- 3 Ręcznie przechyl kamerę internetową w górę lub w dół, aby znaleźć się w jej polu widzenia.

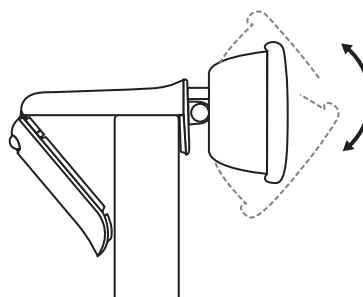

ŁĄCZENIE SIĘ Z KAMERĄ INTERNETOWĄ POPRZECZ KABEL USB-A

Podłącz złącze USB-A do odpowiedniego portu w komputerze.

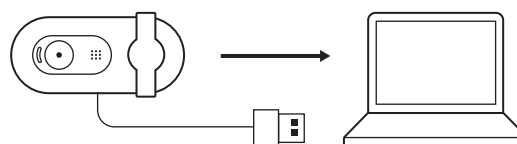

POMYŚLNE POŁĄCZENIE

Dioda LED wskazuje, kiedy kamera internetowa jest włączona i używana przez aplikację.

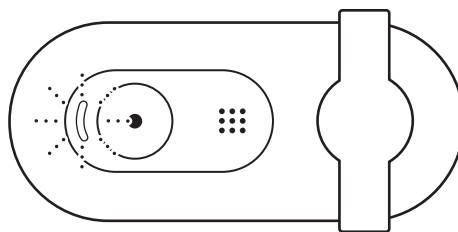

Otwórz osłonę migawki, delikatnie przesuwając ją z lewej na prawą stronę. Upewnij się, że nie zakrywa wbudowanego mikrofonu.

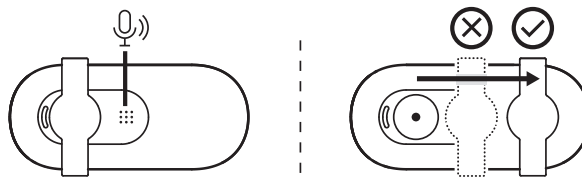

WYMIARY

KAMERA INTERNETOWA:

Wysokość × szerokość × głębokość:

31,91 mm (1,26 cala) × 72,91 mm (2,87 cali) × 66,64 mm (2,62 cala)

Masa: 75 g (2,65 oz)

www.logitech.com/support/Brio100

A TERMÉK ISMERTETÉSE

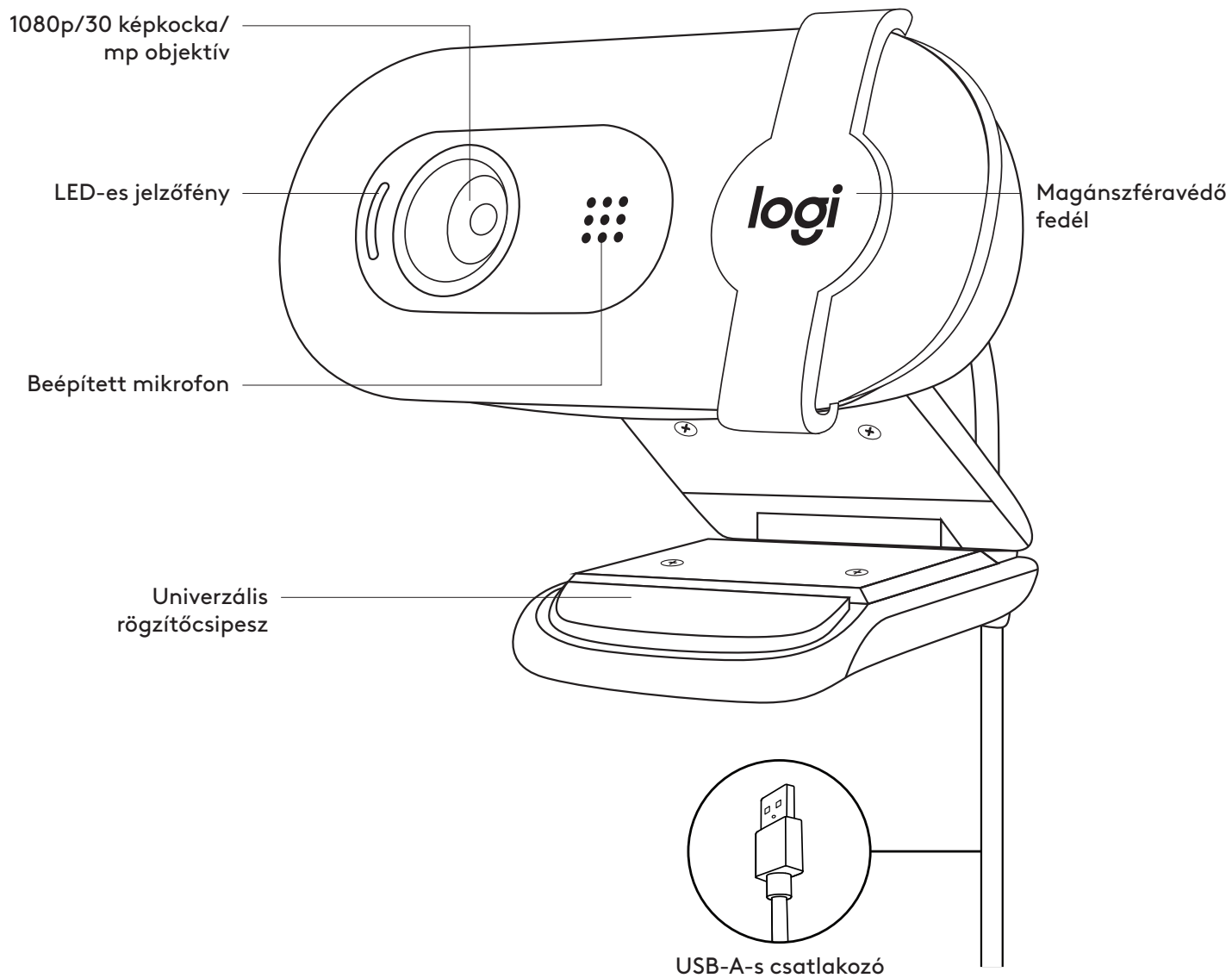

A CSOMAG TARTALMA

- 1 Webkamera 2 m-es (7 láb) rászertelt USB-A-kábellel
- 2 Felhasználói útmutató

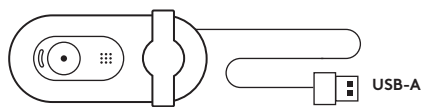

A WEBKAMERA ÜZEMBE HELYEZÉSE

Monitoron való elhelyezéshez

- 1 A webkamerát a számítógépén, laptopján vagy monitorán a kívánt szögben helyezheti el.

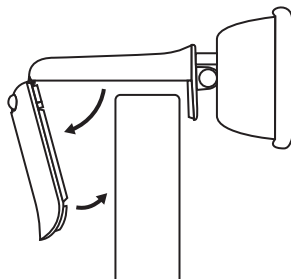

- 2 A webkamera beállításánál ügyeljen arra, hogy az univerzális rögzítőcsipesz vége pontosan ráfeküdjön az eszközre.

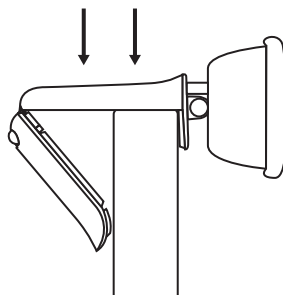

- 3 A webkamerát kézzel döntse felfelé vagy lefelé, hogy a kamera látószögébe kerüljön.

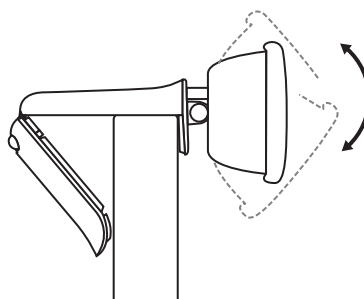

A WEBKAMERA CSATLAKOZTATÁSA USB-A-N KERESZTÜL

Dugja be az USB-A-s csatlakozót a számítógép megfelelő portjába.

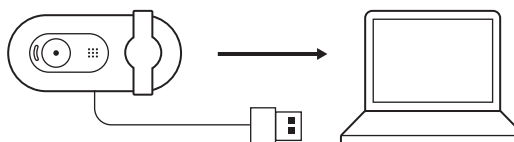

SIKERES CSATLAKOZÁS

A LED fény jelzi, amikor a webkamera bekapcsol,
és egy alkalmazás használja

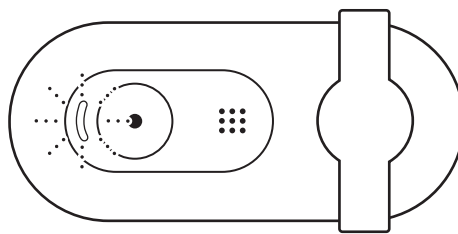

A magánszféravédő fedél felnyitásához finoman
csúsztassa balról teljesen jobbra. Ügyeljen arra,
hogy ne takarja el a beépített mikrofont.

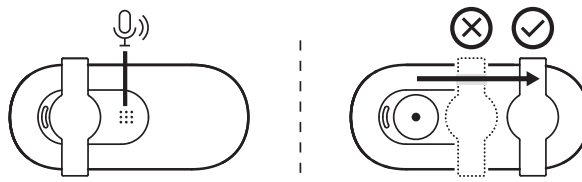

MÉRETEK

WEBKAMERA:

Magasság x szélesség x mélység:

31,91 mm (1,26 hüvelyk) x 72,91 mm (2,87 hüvelyk) x 66,64 mm (2,62 hüvelyk)

Tömeg: 75 g

www.logitech.com/support/Brio100

POPIS PRODUKTU

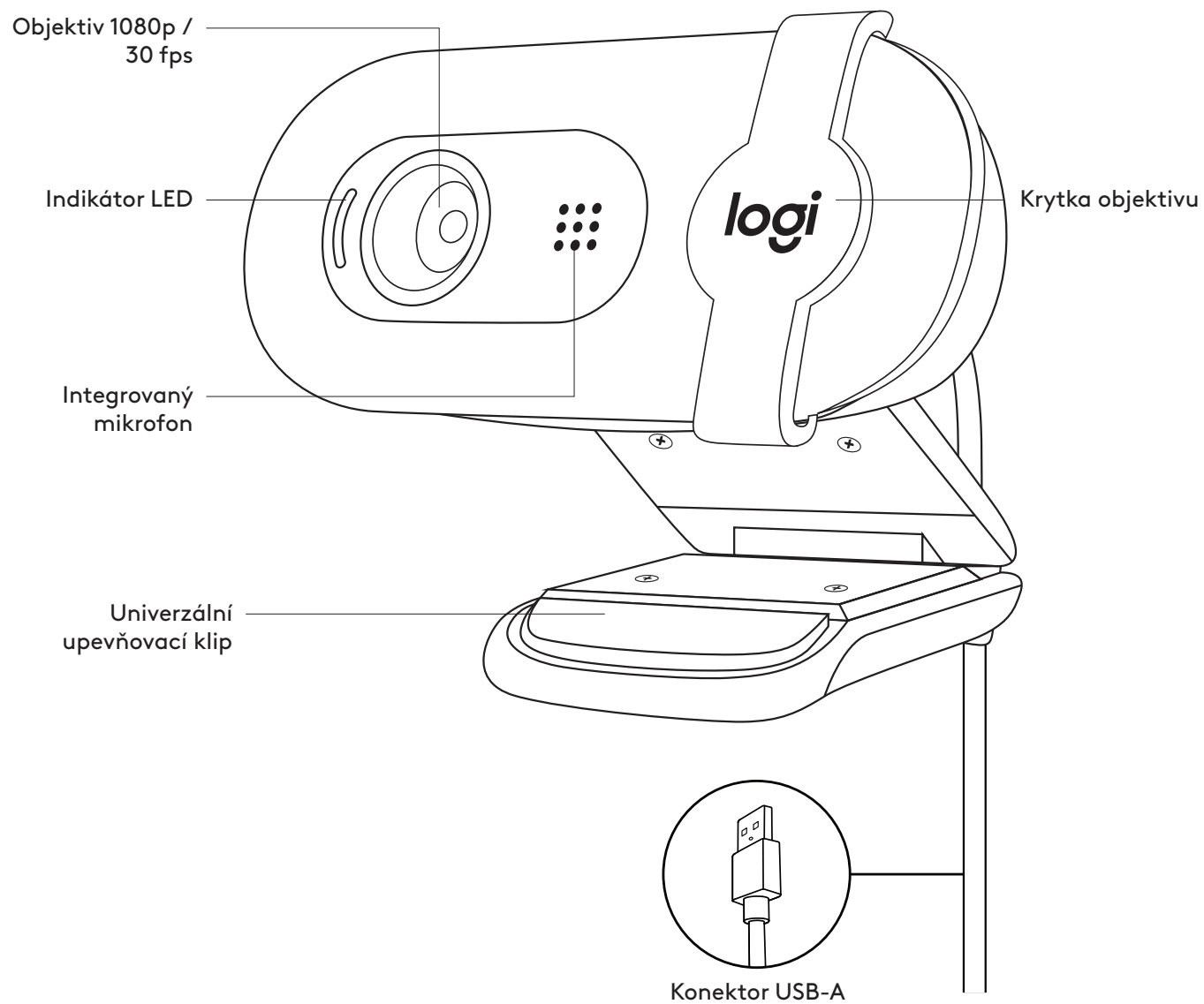

OBSAH BALENÍ

- 1 Webová kamera s připojeným kabelem USB-A o délce 2 m
- 2 Uživatelská dokumentace

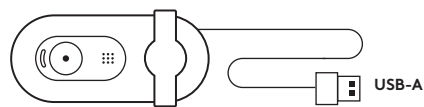

NASTAVENÍ WEBOVÉ KAMERY

Pokyny k umístění na monitor

- 1 Umístěte webovou kameru na počítač, notebook nebo monitor do požadované polohy nebo úhlu.
- 2 Po umístění webové kamery se ujistěte, že je konec univerzálního upevňovacího klipu vyrovnán se zadní částí vašeho zařízení.
- 3 Ručně naklopte webovou kameru nahoru/dolů tak, abyste byli vidět v záběru kamery.

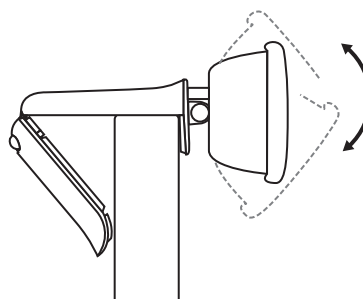
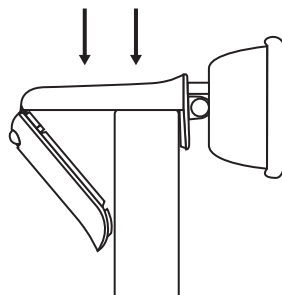
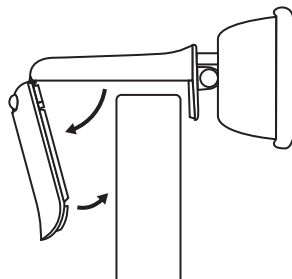

PŘIPOJENÍ WEBOVÉ KAMERY PROSTŘEDNICTVÍM KABELU USB-A

Zapojte konektor USB-A do příslušného portu v počítači.

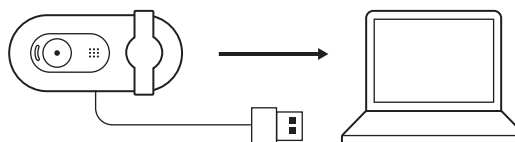

ÚSPĚŠNÉ PŘIHOJENÍ

Indikátor LED signalizuje, když je webová kamera zapnutá a používána aplikací.

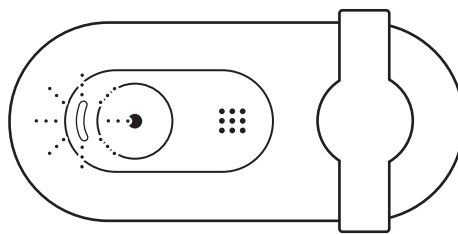

Odkryjte objektiv posunutím krytky zcela vpravo. Ujistěte se, že nezakrývá integrovaný mikrofon.

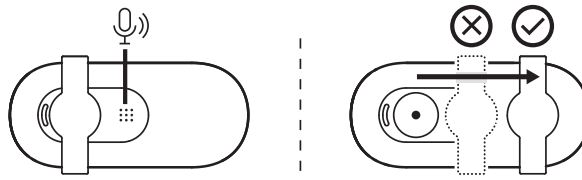

ROZMĚRY

WEBOVÁ KAMERA:

Výška x šířka x hloubka:

31,91 mm (1,26 in) x 72,91 mm (2,87 in) x 66,64 mm (2,62 in)

Hmotnost: 75 g

www.logitech.com/support/Brio100

POPIS PRODUKTU

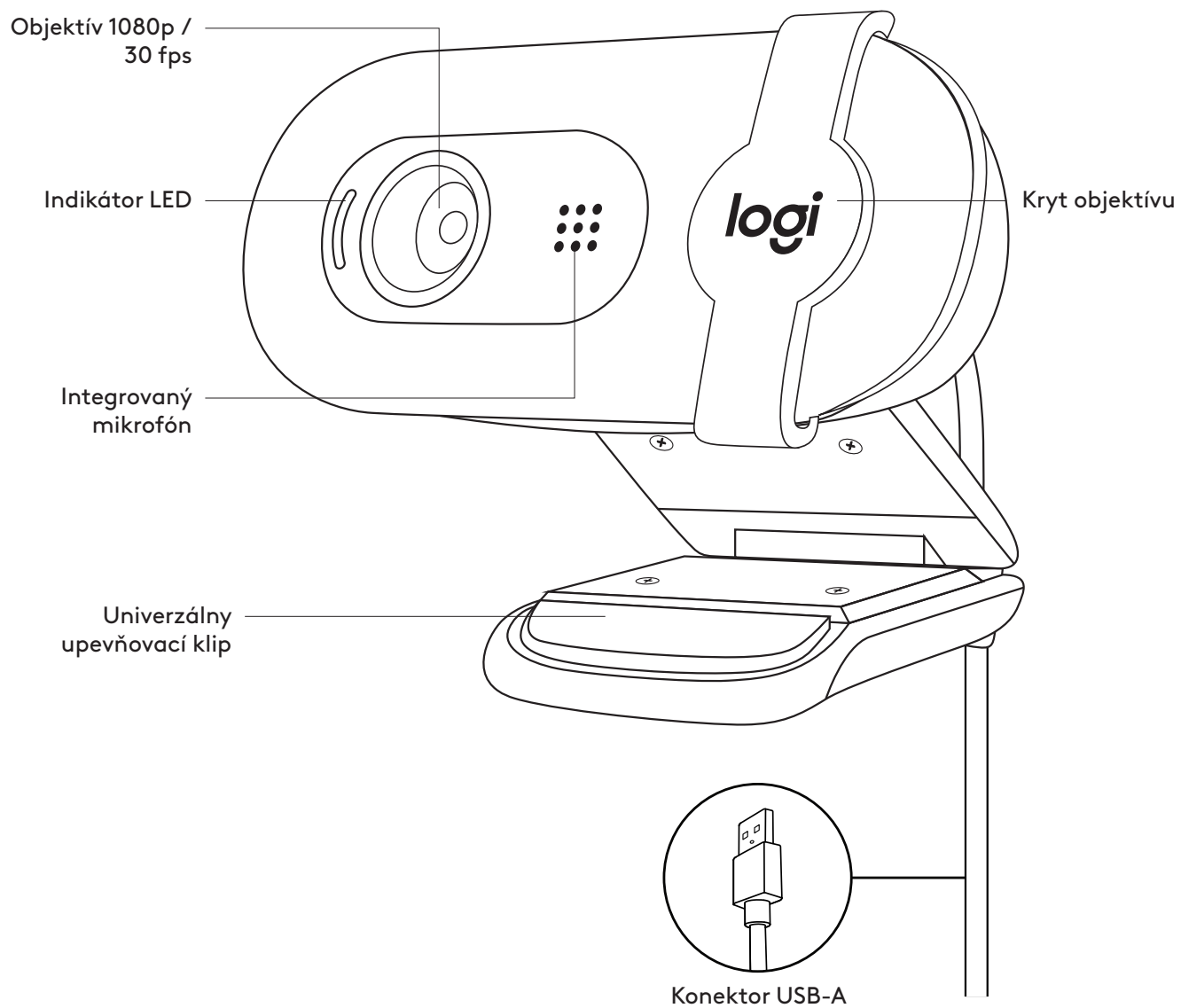

OBSAH BALENIA

- 1 Webová kamera s pripojeným káblom USB-A s dĺžkou 2 m
- 2 Používateľská dokumentácia

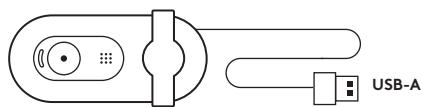

NASTAVENIE WEBOVEJ KAMERY

Pokyny pre umiestnenie na monitor

- 1 Umiestnite webovú kameru na počítač, notebook alebo monitor do požadovanej polohy alebo uhla.
- 2 Po umiestnení webovej kamery sa uistite, že je koniec univerzálneho upevňovacieho klipu zarovnaný so zadnou časťou vášho zariadenia.
- 3 Ručne naklopte webovú kameru nahor/nadol tak, aby ste sa videli v zábere kamery.

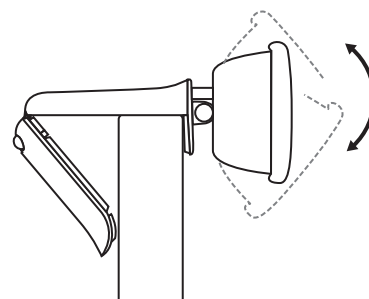
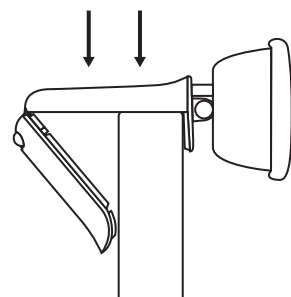
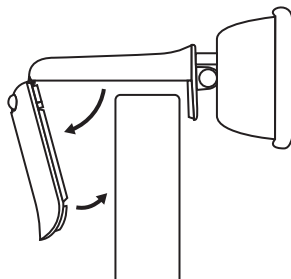

PRIPOJENIE WEBOVEJ KAMERY PROSTREDNÍCTVOM USB-A

Zapojte konektor USB-A do príslušného portu v počítači.

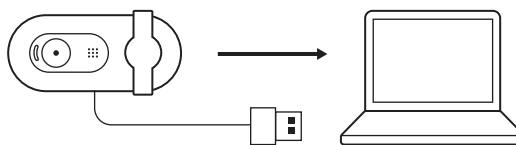

ÚSPEŠNÉ PRIPOJENIE

Indikátor LED signalizuje, keď je webová kamera zapnutá a používaná aplikáciou.

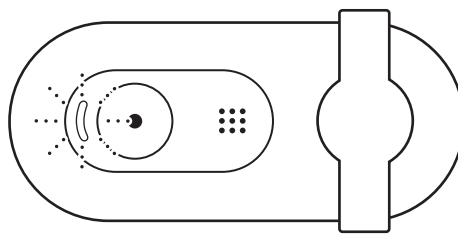

Odkryte objektív posunutím krytu celkom vpravo. Uistite sa, že nezakrýva integrovaný mikrofón.

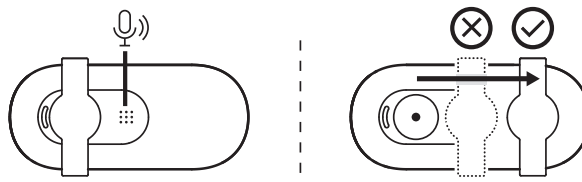

ROZMERY

WEBOVÁ KAMERA:

Výška x šírka x hĺbka:

31,91 mm (1,26 in) x 72,91 mm (2,87 in) x 66,64 mm (2,62 in)

Hmotnosť: 75 g

www.logitech.com/support/Brio100

ОЗНАЙОМЛЕННЯ З ПРИСТРОЄМ

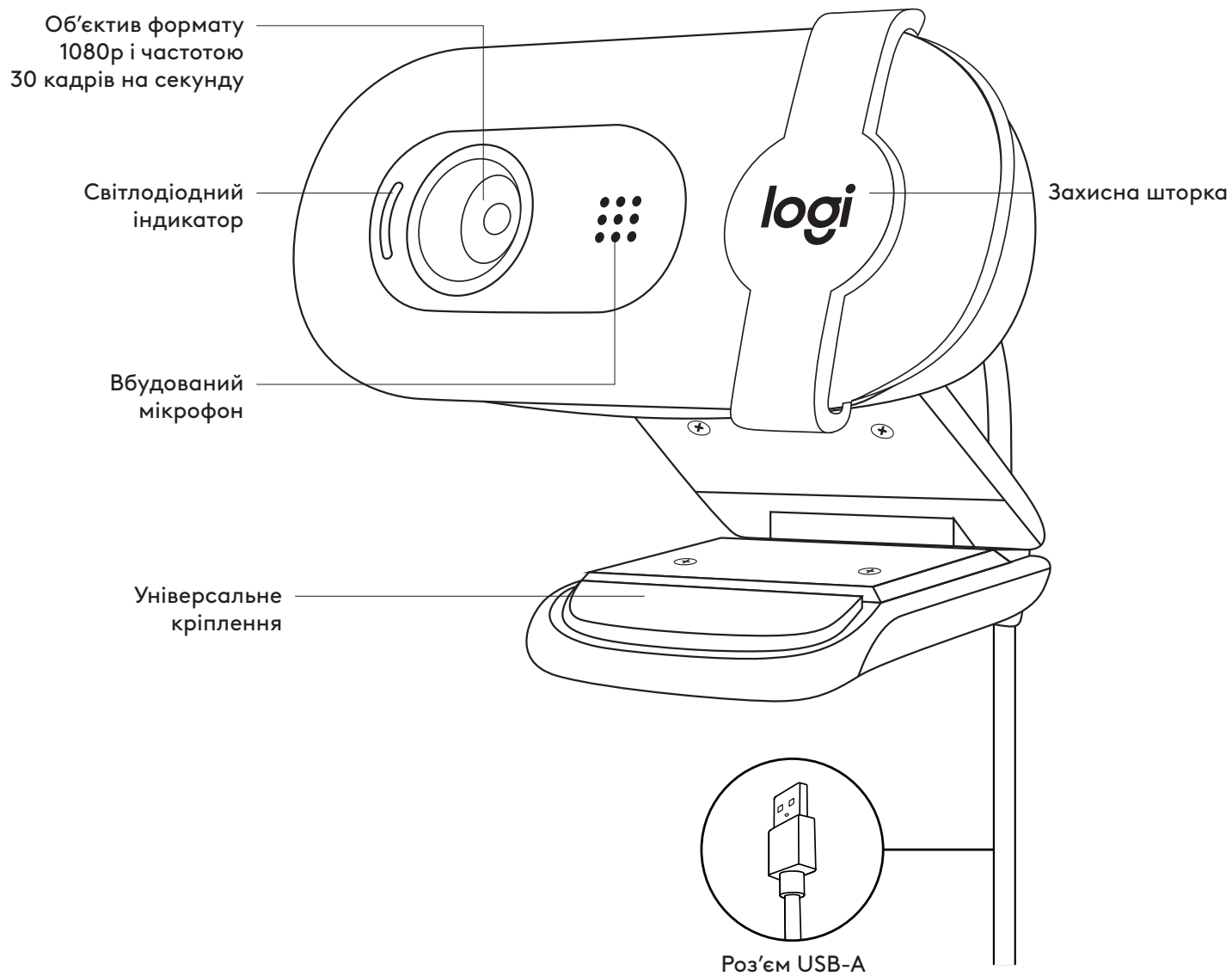

У КОМПЛЕКТІ

- 1 Вебкамера з прикріпленим кабелем USB-A довжиною 2 м (7 футів)
- 2 Документація користувача

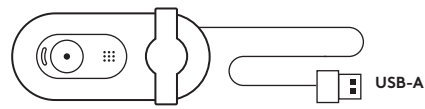

ПІДГОТОВКА ВЕБКАМЕРИ ДО РОБОТИ

Для розташування на моніторі

- 1 Установіть вебкамеру на комп'ютер, ноутбук або монітор у потрібному положенні та під потрібним кутом.

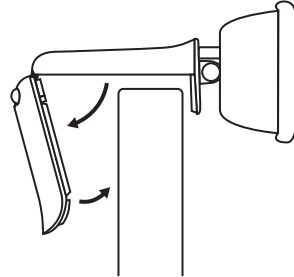

- 2 Відрегулюйте положення вебкамери так, щоб торець універсального кріплення повністю прилягав до задньої панелі пристрою.

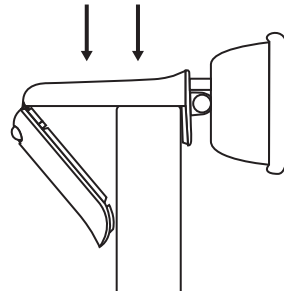

- 3 Вручну регулюйте нахил вебкамери, щоб налаштувати відображення себе в кадрі.

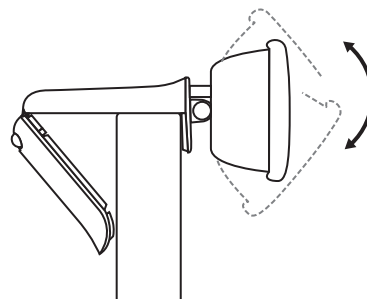

ПІДКЛЮЧЕННЯ ВЕБКАМЕРИ ЗА ДОПОМОГОЮ РОЗ'ЄМУ USB-A

Під'єднайте штекер USB-A до відповідного порту комп'ютера.

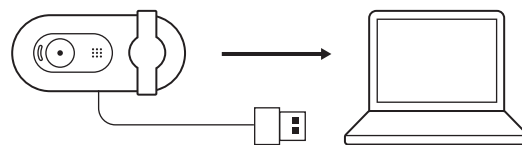

УСПІШНЕ ПІДКЛЮЧЕННЯ

Світлодіодний індикатор сигналізує про те, що вебкамера увімкнена і використовується програмою.

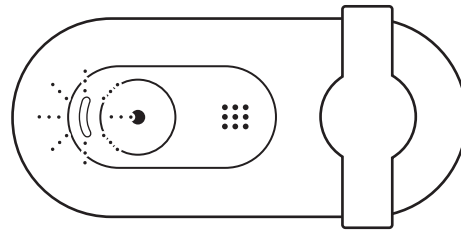

Відкрийте захисну шторку, акуратно пересунувши її зліва направо. Вона не повинна перекривати вбудований мікрофон.

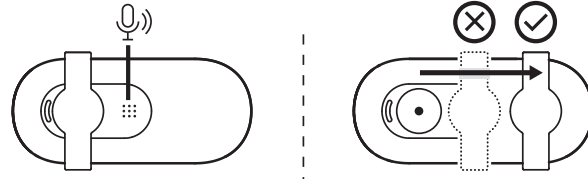

РОЗМІРИ

ВЕБКАМЕРА

Висота x ширина x довжина:
31,91 мм x 72,91 мм x 66,64 мм

Вага: 75 г (2,65 унції)

www.logitech.com/support/Brio100

TOOTE TUTVUSTUS

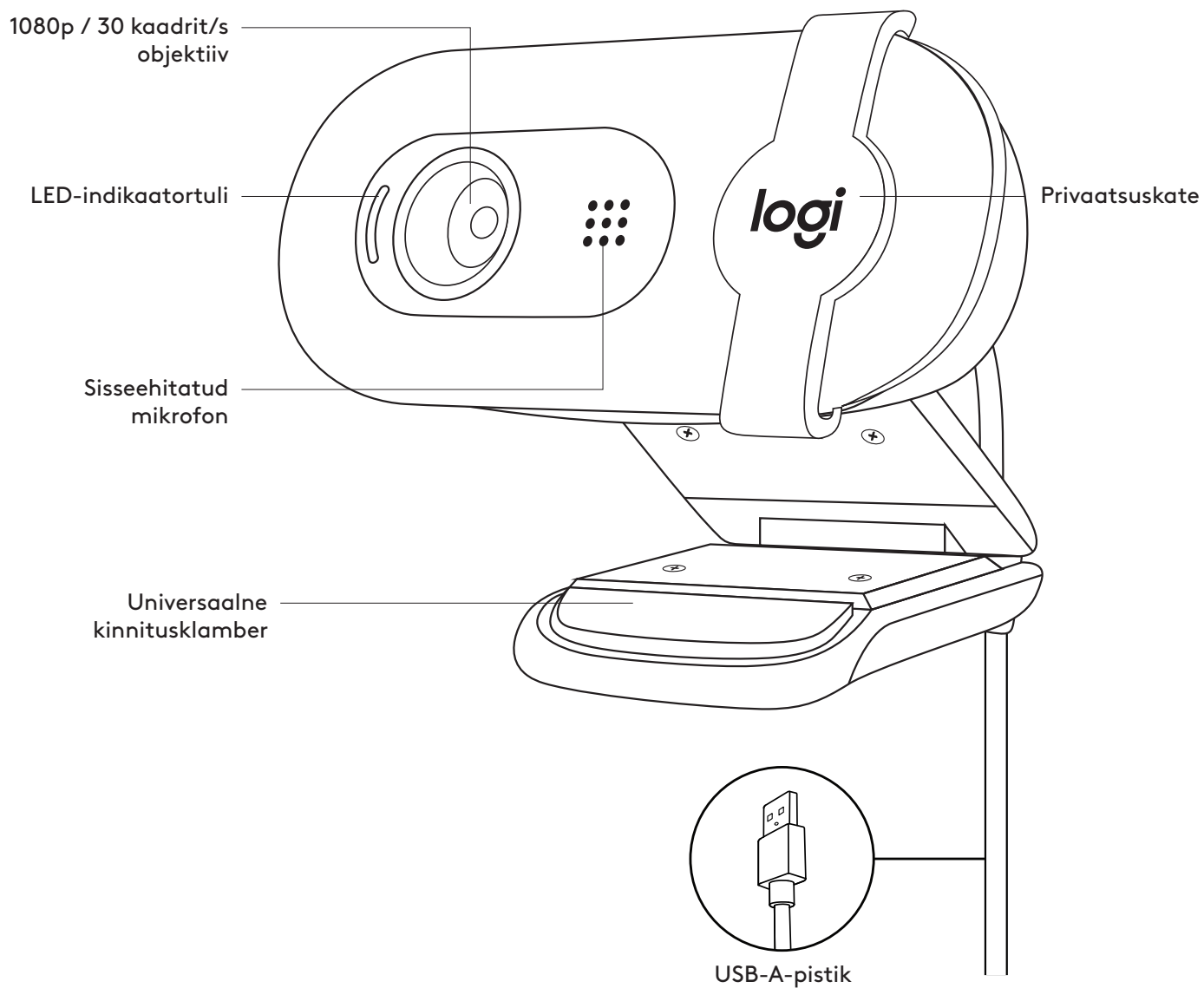

KARBI SISU

- 1 Veebikaamera koos 2 m (7 jala) pikkuse USB-A-kaabliga
- 2 Kasutaja dokumentatsioon

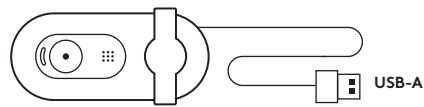

VEEBIKAAMERA SEADISTAMINE

Monitori külge kinnitamiseks

- 1 Asetage veebikaamera arvutile, sülearvutile või monitorile soovitud asendis või nurga all.

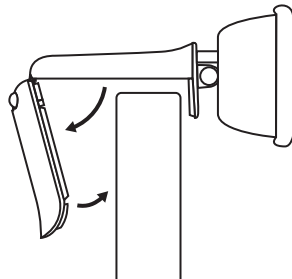

- 2 Reguleerige veebikaamerat ja veenduge, et universaalse kinnitusklambri ots oleks seadme tagaküljega samal tasapinnal.

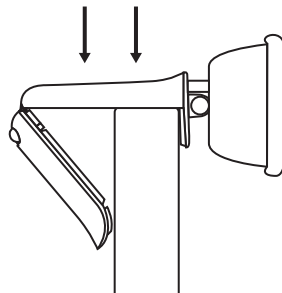

- 3 Kallutage veebikaamerat käsitsi üles või alla, et jääksite kaamera vaatevälja.

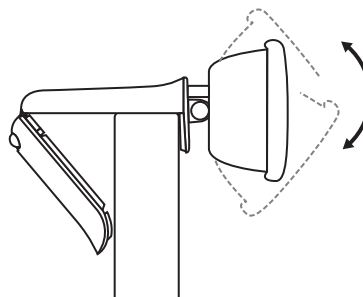

VEEBIKAAMERA ÜHENDAMINE USB-A KAUDU

Ühendage USB-A-pistik otse oma arvuti sobivasse porti.

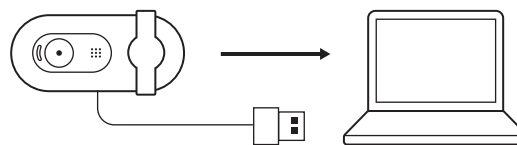

EDUKAS ÜHENDUS

LED-tuli näitab, kui veebikaamera on sisse lülitatud ja kui rakendus kasutab.

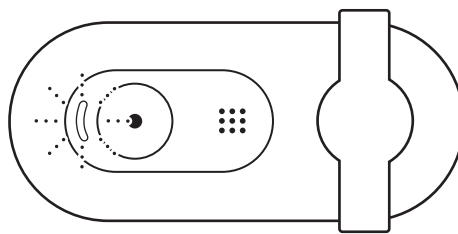

Avage privaatsuskate, libistades seda õrnalt vasakult täiesti paremale. Veenduge, et see ei kataks sisseehitatud mikrofoni.

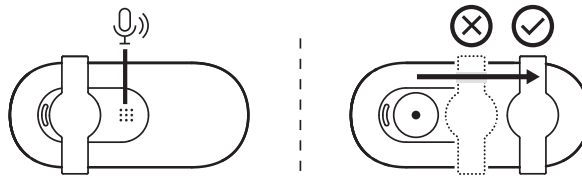

MÕÕTMED

VEEBIKAAMERA:

Kõrgus x laius x sügavus:
31,91 mm (1,26 tolli) x 72,91 mm (2,87 tolli) x 66,64 mm (2,62 tolli)

Kaal: 75 g (2,65 untsi)

www.logitech.com/support/Brio100

IERĪCES APRAKSTS

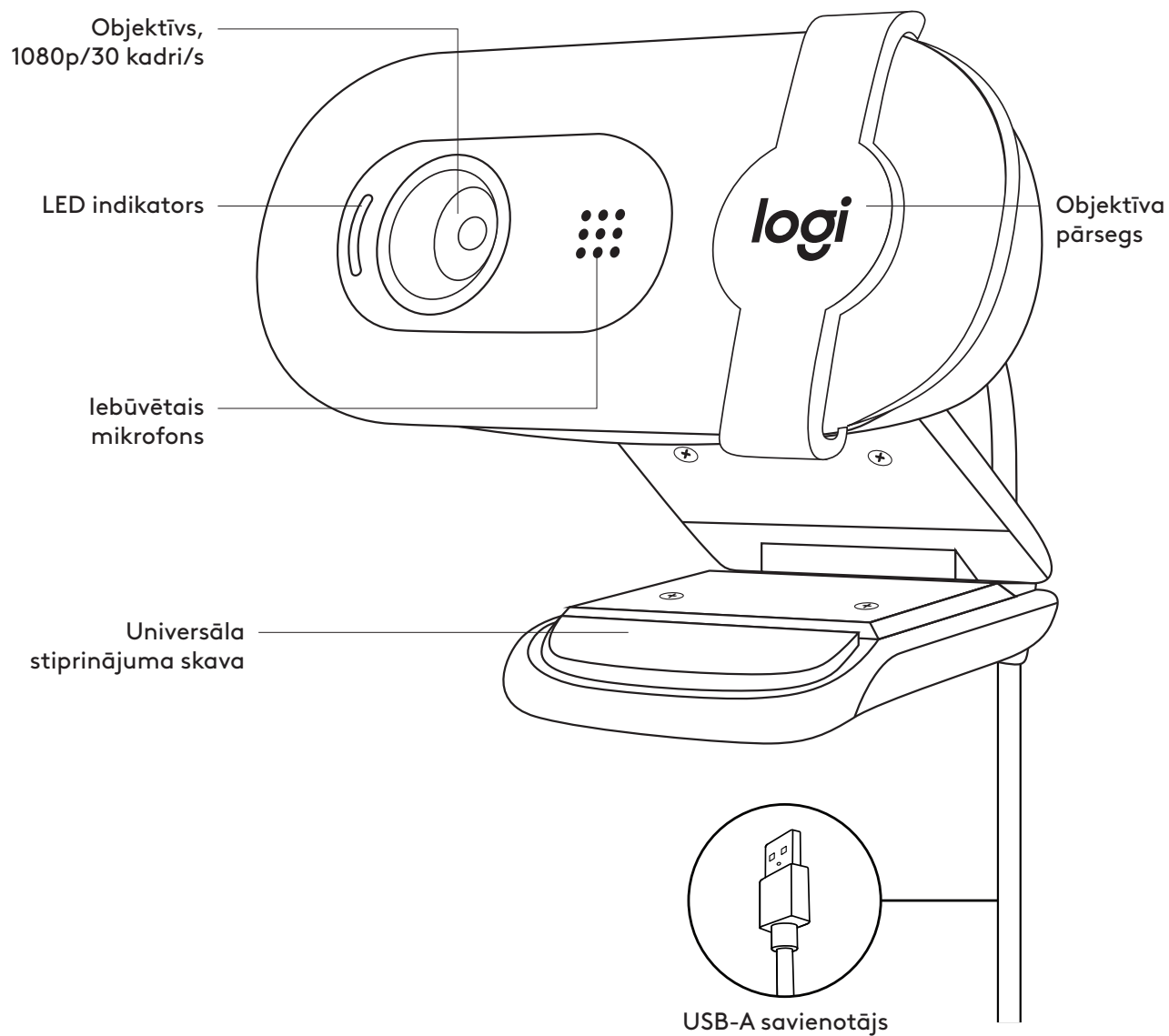

IEPAKOJUMA SATURS

- 1 Tīmekļa kamera ar pievienotu 2 m (7 pēdu) USB-A kabeli
- 2 Lietotāja dokumentācija

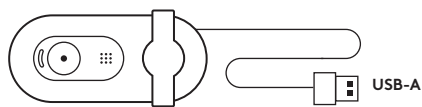

TĪMEKĻA KAMERAS IESTATĪŠANA

Piestiprināšana pie monitora

- 1 Novietojiet tīmekļa kameru vēlamajā vietā un leņķī uz datora, klēpjatora vai monitora.

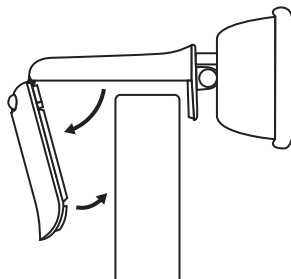

- 2 Noregulējiet tīmekļa kameru, lai universālā stiprinājuma skava cieši piegultu ierīces aizmugurei.

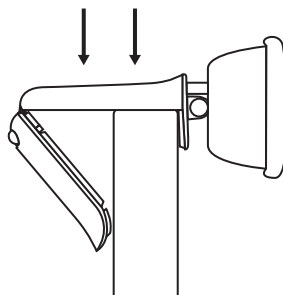

- 3 Ar roku sasveriet tīmekļa kameru uz augšu vai uz leju, lai kadrētu sevi kameras skatā.

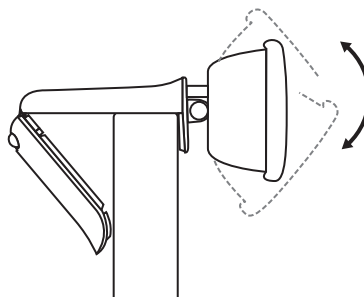

TĪMEKĻA KAMERAS PIEVIENOŠANA, IZMANTOJOT USB-A KABELI

Iespraudiet USB-A savienotāju atbilstošajā datora pieslēgvietā.

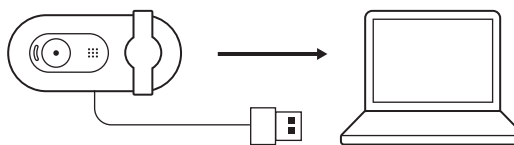

SEKMĪGA SAVIENOJUMA IZVEIDE

LED indikators parāda, kad tīmekļa kamera ir ieslēgta un to izmanto kāda lietotne.

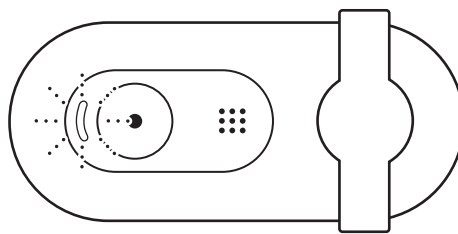

Atveriet objektīva pārsegu, to uzmanīgi pāvirzot no kreisās puses pilnībā līdz labajai pusei. Raugieties, lai tas neaizsegto iebūvēto mikrofonu.

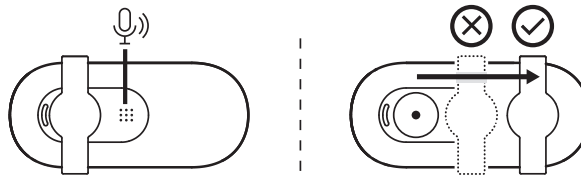

IZMĒRI

TĪMEKĻA KAMERA

Augstums x platums x dziļums:

31,91 mm (1,26 collas) x 72,91 mm (2,87 collas) x 66,64 mm (2,62 collas)

Svars: 75 g (2,65 unces)

www.logitech.com/support/Brio100

SUSIPAŽINKITE SU SAVO PRODUKTU

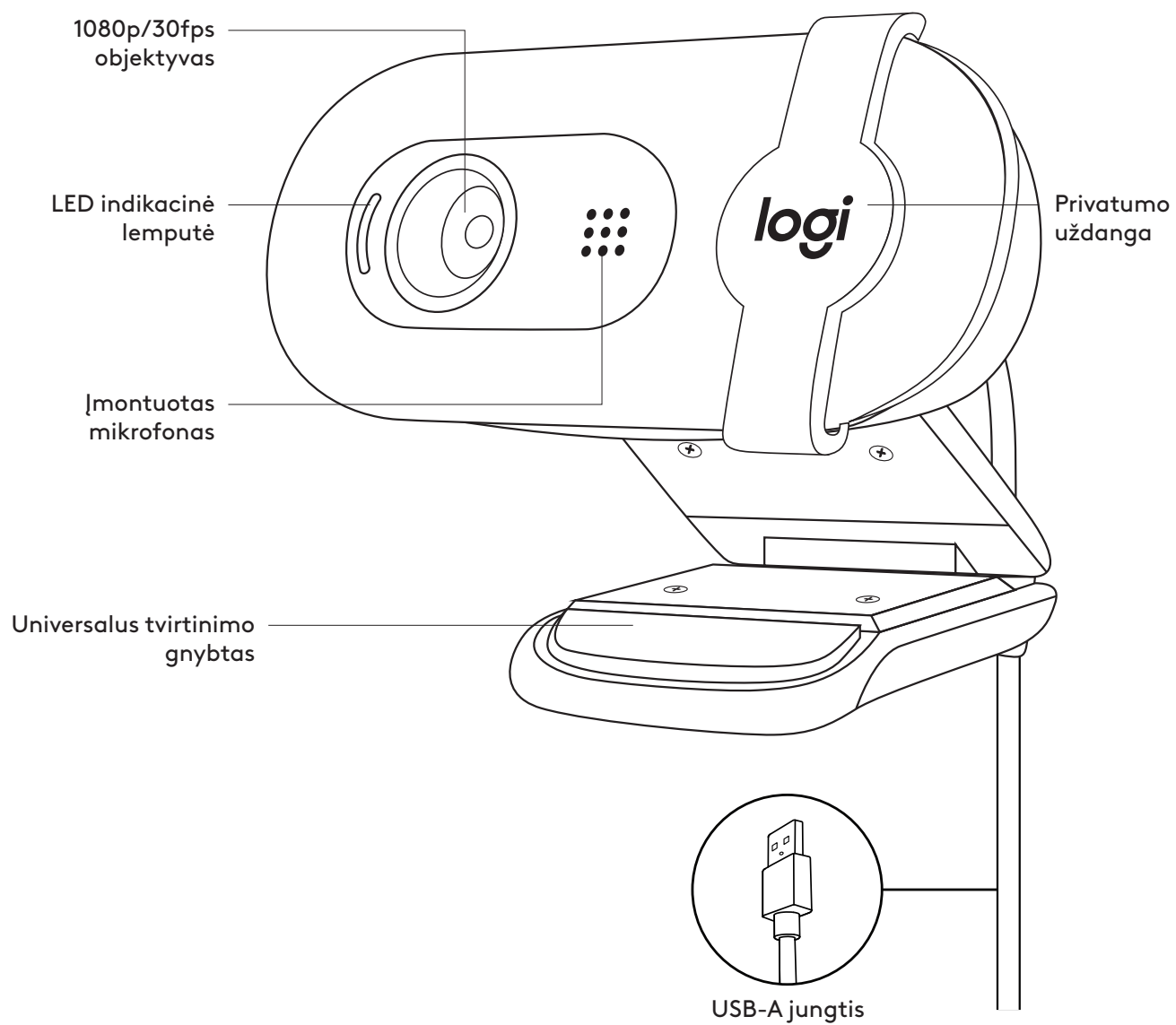

DĖŽUTĖJE YRA

- 1 Internetinė vaizdo kamera su 2 m (7 pėd.) pritvirtintu USB-A laidu
- 2 Naudotojo dokumentacija

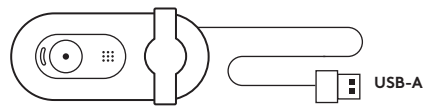

ŽINIATINKLIO KAMEROS PARUOŠIMAS

Ant monitoriaus

- 1 Internetinę vaizdo kamerą tvirtinkite prie kompiuterio, nešiojamojo kompiuterio arba monitoriaus norimoje padėtyje arba norimu kampu.

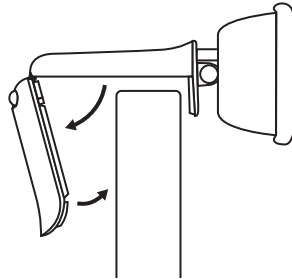

- 2 Sureguliuokite internetinę vaizdo kamerą, kad universalus tvirtinimo gnybtų galas priglustų prie jūsų įrenginio galinės dalies.

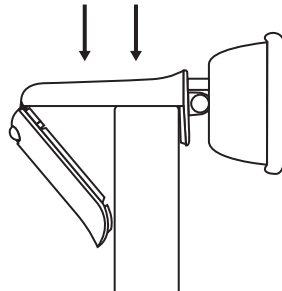

- 3 Ranka pakreipkite internetinę vaizdo kamerą aukštyn arba žemyn, kad būtumėte kameros vaizdo rėmelyje.

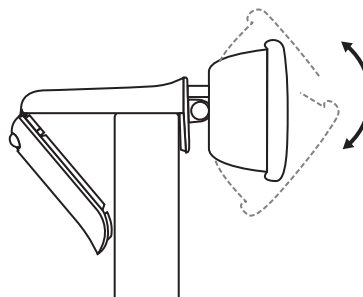

INTERNETINĖS VAIZDO KAMEROS PRIJUNGIMAS SU USB-A

Prijunkite pritvirtintą USB-A jungtį prie atitinkamo kompiuterio lizdo.

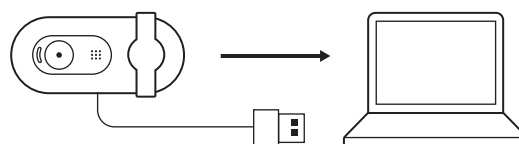

SĖKMINGAS PRIJUNGIMAS

LED lemputė nurodo, kai internetinė vaizdo kamera yra įjungta ir ją naudoja programėlė.

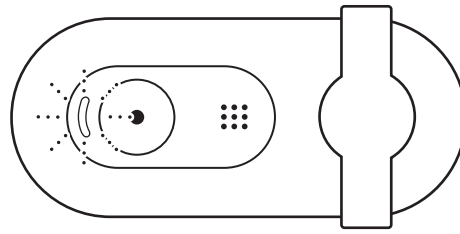

Atidarykite privatumo uždangą švelniai patraukdami ją iš kairės iki galo į dešinę. Įsitikinkite, kad ji neuždengia įmontuoto mikrofono.

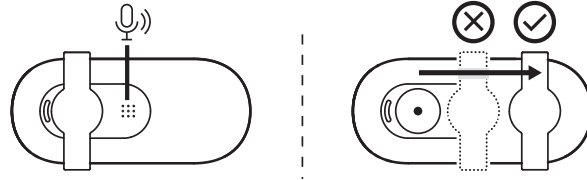

MATMENYS

INTERNETINĖ VAIZDO KAMERA:

aukštis x plotis x gylis:
31,91 x 72,91 x 66,64 mm (1,26 x 2,87 x 2,62 col.)

Svoris: 75 g (2,65 unc.)

www.logitech.com/support/Brio100

ЗАПОЗНАЙТЕ СЕ СЪС СВОЯ ПРОДУКТ

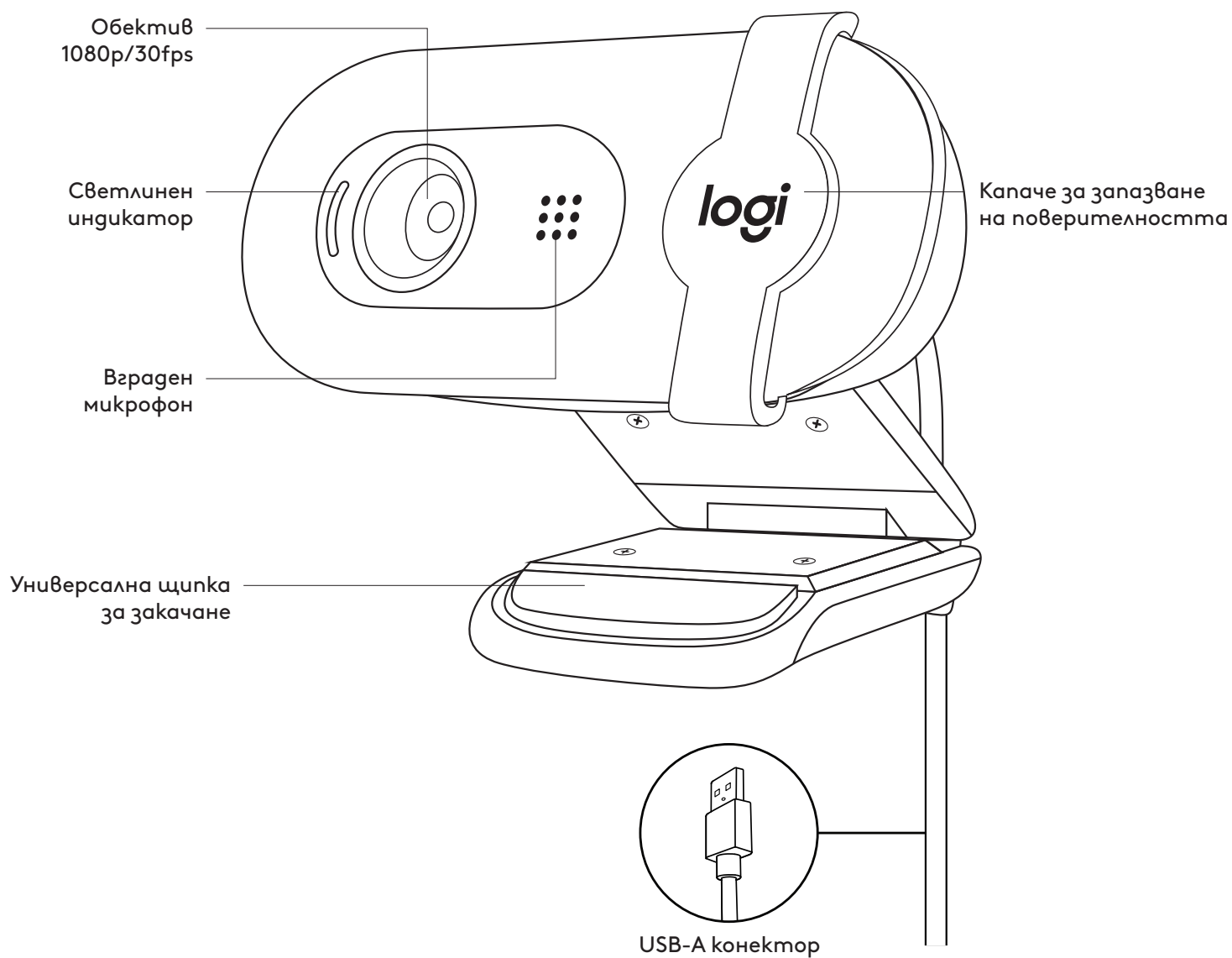

СЪДЪРЖАНИЕ НА КУТИЯТА

- 1 Уеб камера с поставен 7 ft (2 м) USB-A кабел
- 2 Документация за потребителя

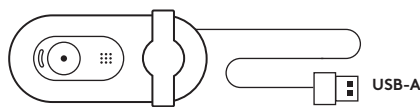

НАСТРОЙКА НА УЕБ КАМЕРАТА

За поставяне на монитор

- 1 Поставете уеб камерата върху компютър, лаптоп или монитор в желаното от вас положение или ъгъл.

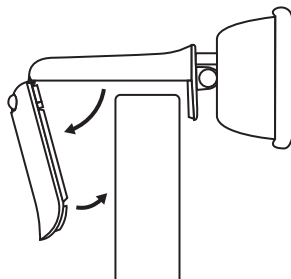

- 2 Регулирайте уеб камерата така, че да сте сигурни, че краят на универсалната щипка за закачане е подравнена с гърба на устройството.

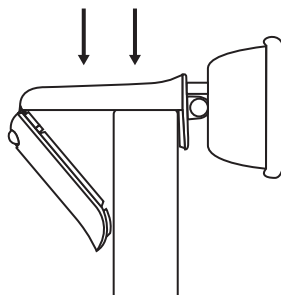

- 3 Завъртете ръчно уеб камерата нагоре или надолу, за да напаснете образа си в изгледа на камерата.

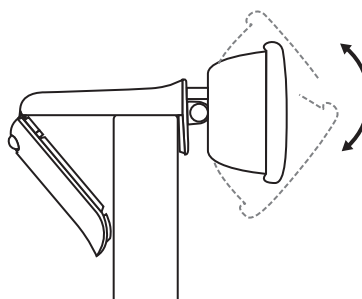

СВЪРЗВАНЕ НА УЕБ КАМЕРАТА ЧРЕЗ USB-A

Включете USB-A конектора в съответния порт на компютъра.

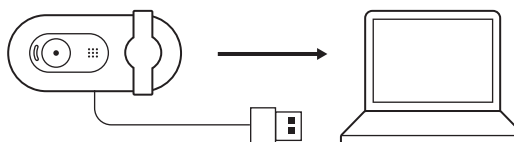

УСПЕШНО СВЪРЗВАНЕ

Светлинният индикатор указва, че уеб камерата е включена и се използва от приложение.

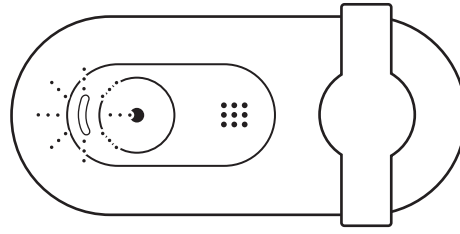

Отворете капачето за запазване на поверителността, като внимателно го плъзнете отляво изцяло докрай вдясно. Важно е то да не покрива вградения микрофон.

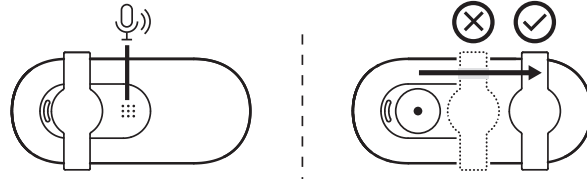

РАЗМЕРИ

УЕБКАМЕРА:

Височина x ширина x дълбочина:
1,26 in (31,91 мм) x 2,87 in (72,91 мм) x 2,62 in (66,64 мм)

Тегло: 2,65 oz (75 г)

www.logitech.com/support/Brio100

UPOZNAJTE SVOJ UREĐAJ

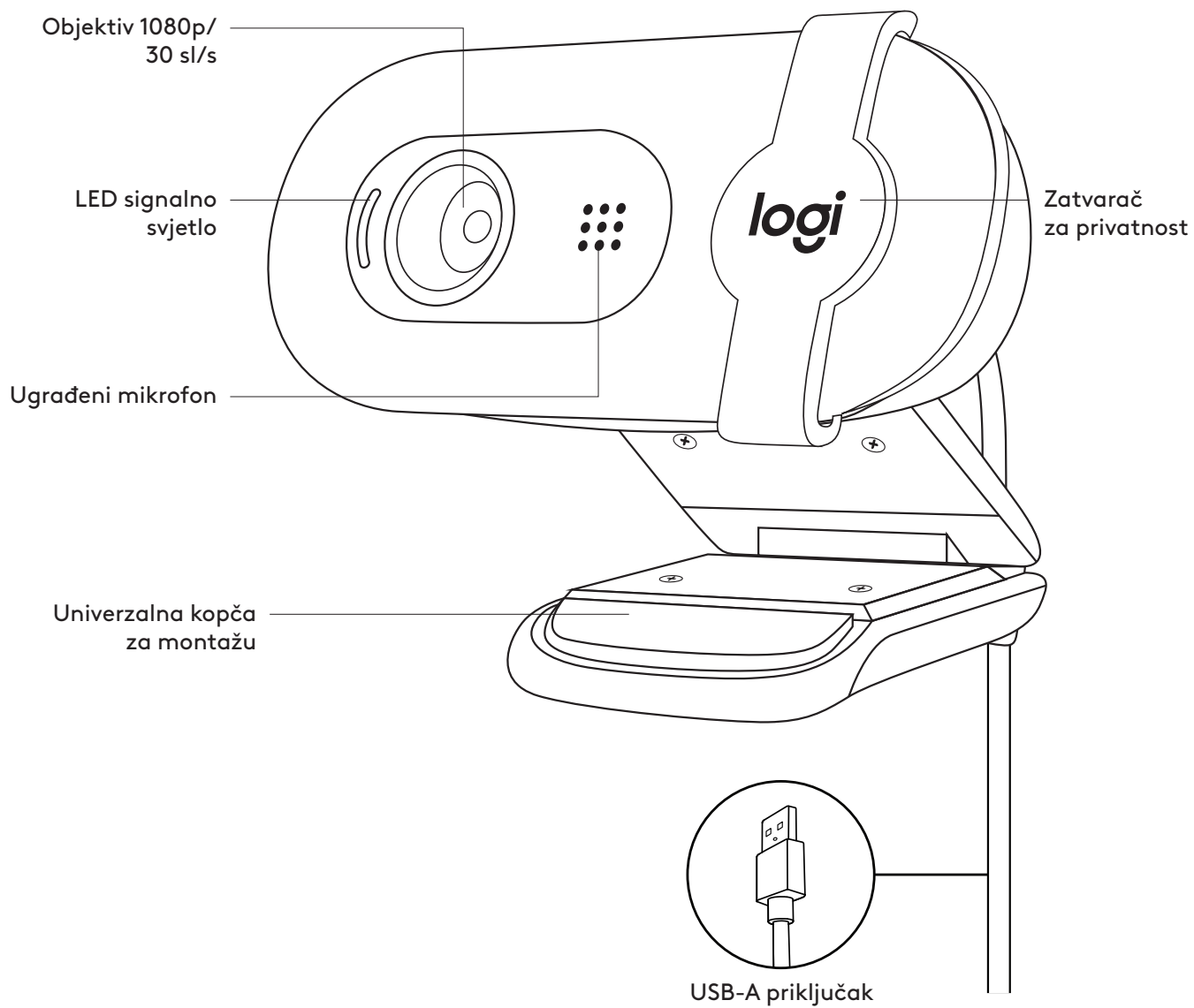

SADRŽAJ KUTIJE

- 1 Web kamera s priključnim USB-A kabelom od 2 m (7 ft)
- 2 Korisnička dokumentacija

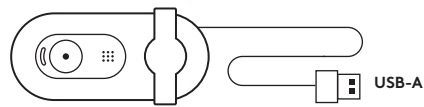

POSTAVLJANJE WEB KAMERE

Postavljanje na monitor

- 1 Stavite web kameru na stolno/prijenosno računalo ili na monitor na mjesto i u položaj po vašoj želji.

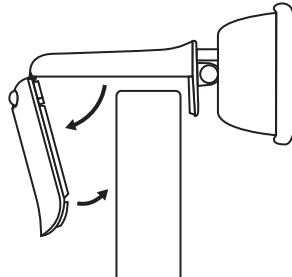

- 2 Prilagodite web kameru tako da kraj univerzalne kopče za montažu bude poravnat sa stražnjom stranom uređaja.

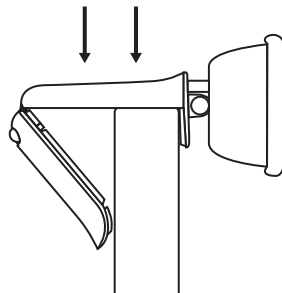

- 3 Rukom nagnite web kameru prema dolje ili prema gore tako da se nađete u kadru kamere.

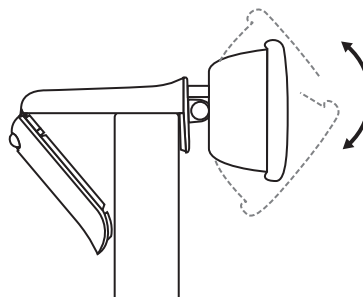

SPAJANJE WEB KAMERE PREKO USB-A PRIKLJUČKA

Ukopčajte USB-A priključak u odgovarajući priključak na računalu.

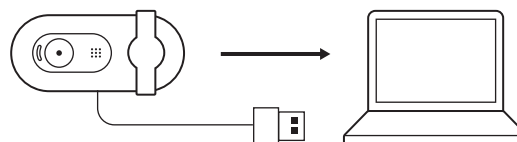

USPJEŠNO POVEZIVANJE

LED svjetlo označava kada je web kamera uključena i kada ju koristi aplikacija.

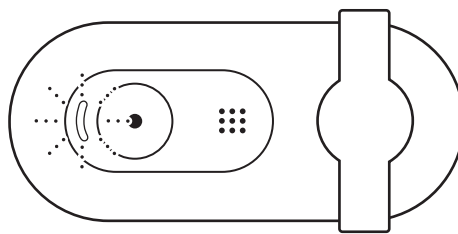

Otvorite zatvarač za privatnost pažljivim povlačenjem slijeva do kraja udesno. Pazite da on ne prekrije ugrađeni mikrofon.

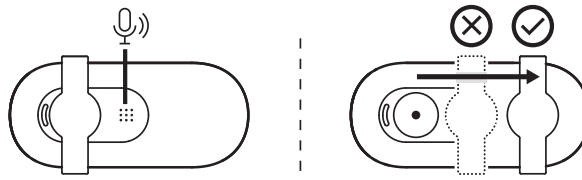

DIMENZIJE

WEB KAMERA.

Visina x širina x dubina:

31,91 mm (1,26 inča) x 72,91 mm (2,87 inča) x 66,64 mm (2,62 inča)

Težina: 75 g (2,65 oz)

www.logitech.com/support/Brio100

UPOZNAJTE SVOJ PROIZVOD

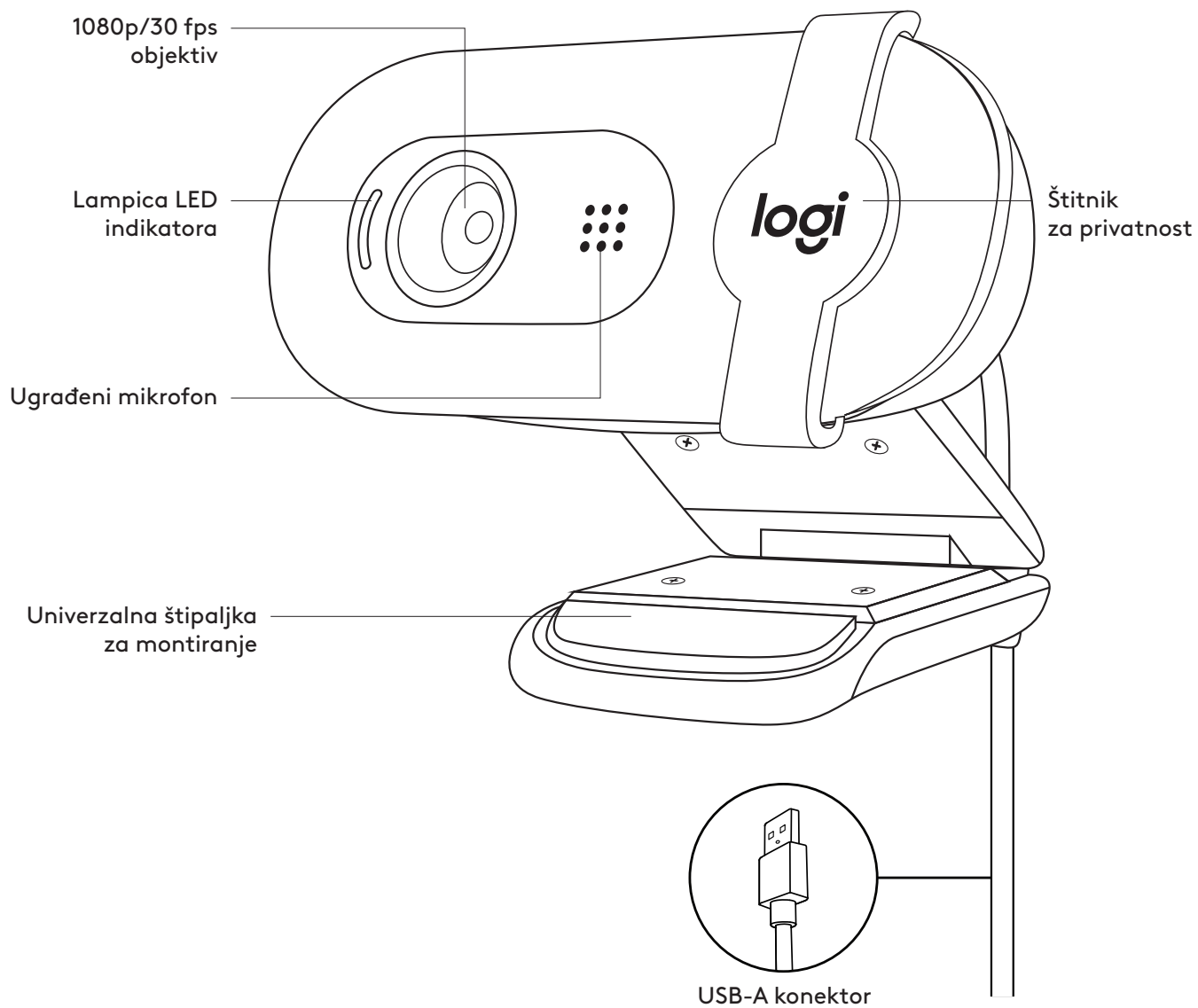

SADRŽAJ PAKOVANJA

- 1 Veb kamera sa povezanim USB-A kablom od 2 m (7 stopa)
- 2 Dokumentacija za korisnika

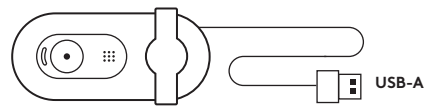

PODEŠAVANJE VEB KAMERE

Za postavljanje na monitor

- 1 Postavite veb kameru na računar, laptop ili monitor pod željenim uglom.

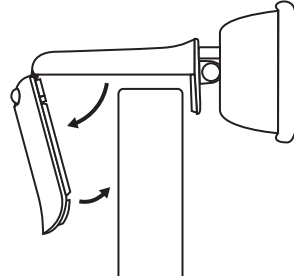

- 2 Podesite veb kameru tako da kraj univerzalne štipaljke za montiranje bude u ravni sa zadnjom stranom uređaja.

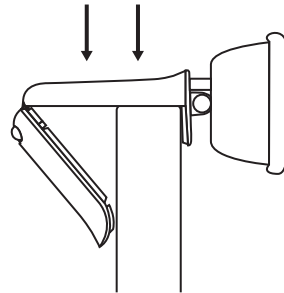

- 3 Ručno nagnite veb kameru nagore ili nadole da biste bili u kadru.

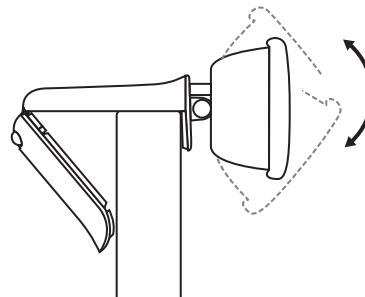

POVEZIVANJE VEB KAMERE UZ USB-A

Povežite USB-A konektor u odgovarajući port na računaru.

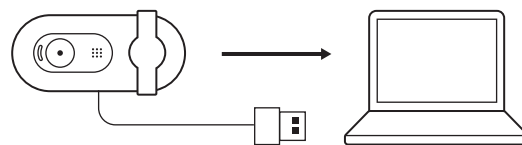

USPEŠNO POVEZIVANJE

LED lampica pokazuje kada je veb kamera uključena i kada je koristi neka aplikacija.

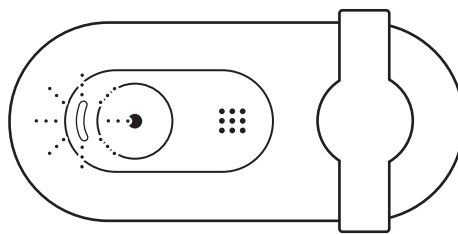

Otvorite štitnik za privatnost tako što ćete ga blago pomeriti sleva do kraja nadesno. Proverite da ne pokriva ugrađeni mikrofون.

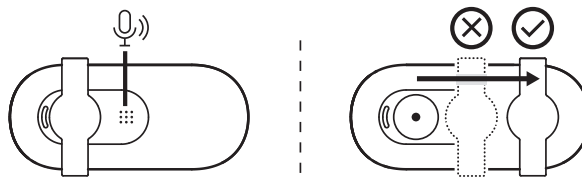

DIMENZIJE

VEB KAMERA:

Visina x širina x dužina:

31,91 mm (1,26 inča) x 72,91 mm (2,87 inča) x 66,64 mm (2,62 inča)

Težina: 75 g (2,65 unci)

www.logitech.com/support/Brio100

SPOZNAJTE IZDELEK

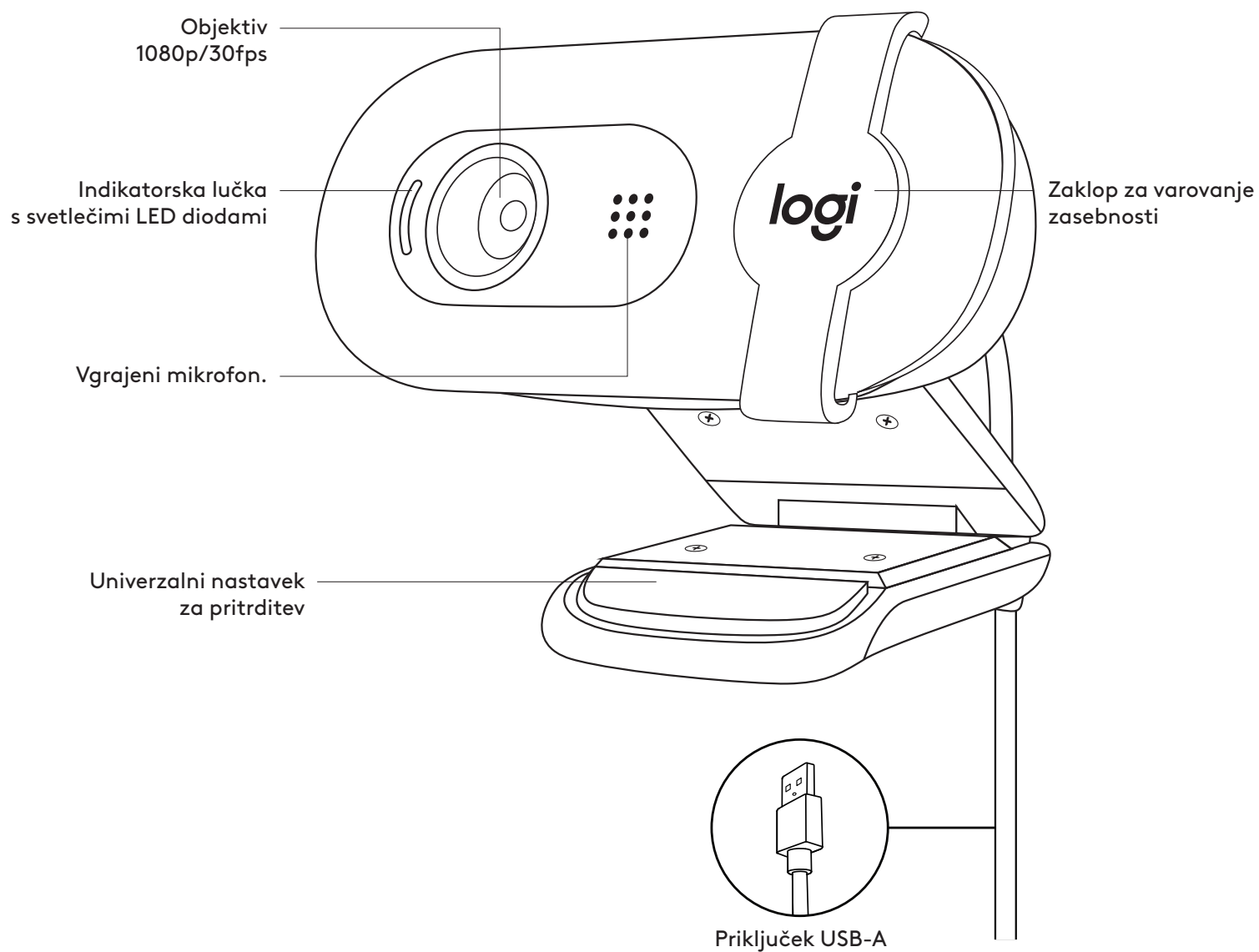

VSEBINA ŠKATLE

- 1 Spletna kamera s 2 m (7 ft) pritrjenim kablom USB-A
- 2 Uporabniška dokumentacija

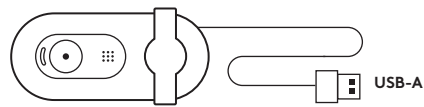

NAMESTITEV SPLETNE KAMERE

Namestitev na zaslon

- 1 Namestite spletno kamero na računalnik, prenosnik ali monitor v želeni položaj ali kot.

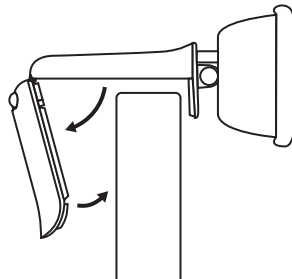

- 2 Prilagodite spletno kamero tako, da bo konec univerzalnega nastavka za pritržitev poravnana s hrbtno stranjo vaše naprave.

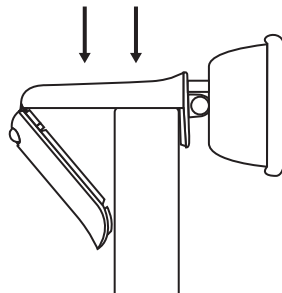

- 3 Ročno nagnite spletno kamero navzgor ali navzdol, da se umestite v okvir pogleda kamere.

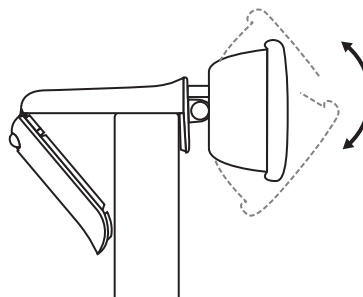

POVEZOVANJE SPLETNE KAMERE PREK USB-A

Priključek USB-A priključite neposredno v ustrezna vrata v vašem računalniku.

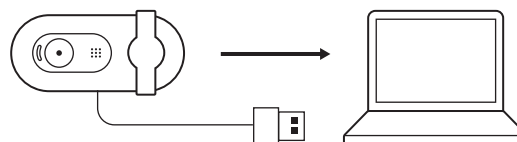

USPEŠNA POVEZAVA

Svetleča dioda LED označuje, kdaj je spletna kamera vklopljena in se uporablja v aplikaciji.

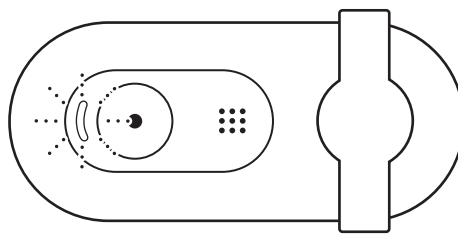

Odprite zaklop za varovanje zasebnosti tako, da ga nežno premaknete od leve proti desni. Pazite, da ne prekrijete vgrajenega mikrofona.

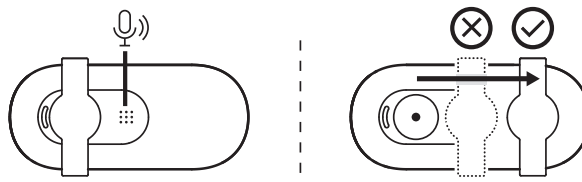

DIMENZIJE

SPLETNA KAMERA:

Višina x širina x globina:

31,91 mm (1,26 in) x 72,91 mm (2,87 in) x 66,64 mm (2,62 in)

Teža: 75 g (2,65 oz)

www.logitech.com/support/Brio100

FAMILIARIZAȚI-VĂ CU PRODUSUL

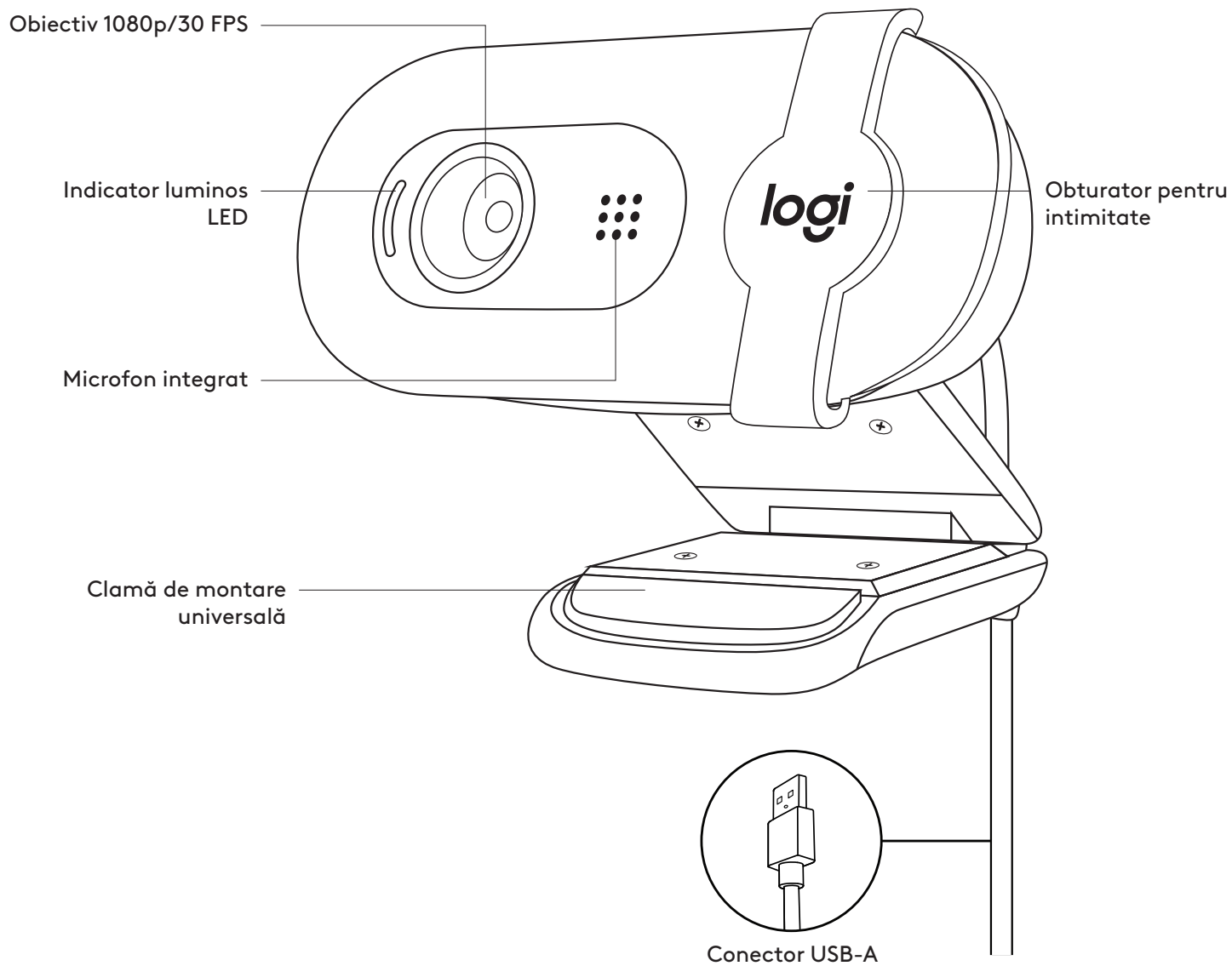

CONȚINUTUL CUTIEI

- 1 Cameră web cu cablu USB-A de 2 m atașat
- 2 Documentație pentru utilizator

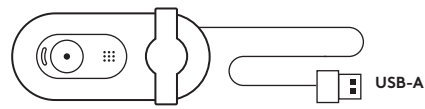

CONFIGURAREA CAMEREI

Pentru plasarea pe monitor

- 1 Plasați camera web pe un computer, laptop sau monitor în poziția sau unghiul dorit.

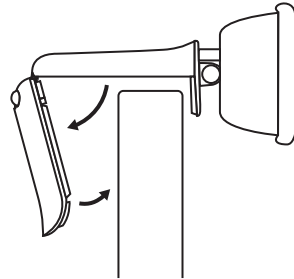

- 2 Reglați camera web pentru a vă asigura că terminația clamei de montare universale este aliniată la partea din spate a dispozitivului dvs.

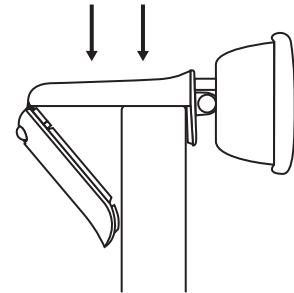

- 3 Înclinați manual camera web în sus sau în jos, pentru a vă încadra în câmpul de vizualizare al camerei.

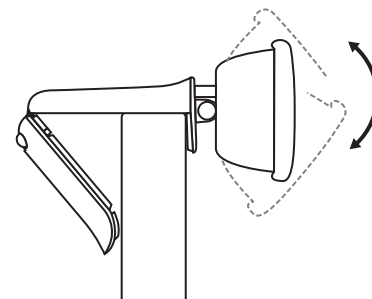

CONECTAREA CAMEREI WEB PRIN USB-A

Conectați conectorul USB-A în portul corespunzător al computerului.

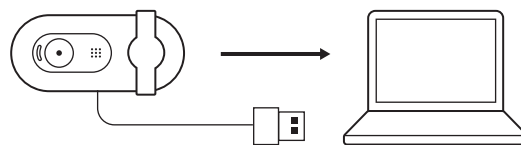

CONEXIUNE REUȘITĂ

Indicatorul luminos LED arată când camera web este pornită și utilizată de către o aplicație.

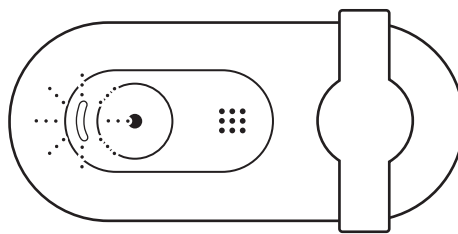

Deschideți obturatorul pentru intimitate, glisându-l încet și complet de la stânga la dreapta. Asigurați-vă că nu acoperă microfonul integrat.

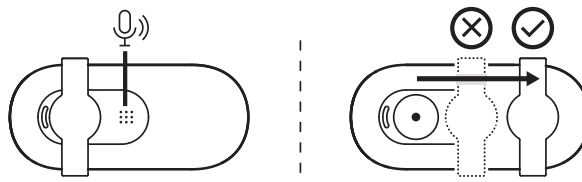

DIMENSIUNI

CAMERĂ WEB:

Înălțime x lățime x adâncime:
31,91 mm x 72,91 mm x 66,64 mm

Greutate: 75 g

www.logitech.com/support/Brio100

ÜRÜNÜNÜZÜ TANIYIN

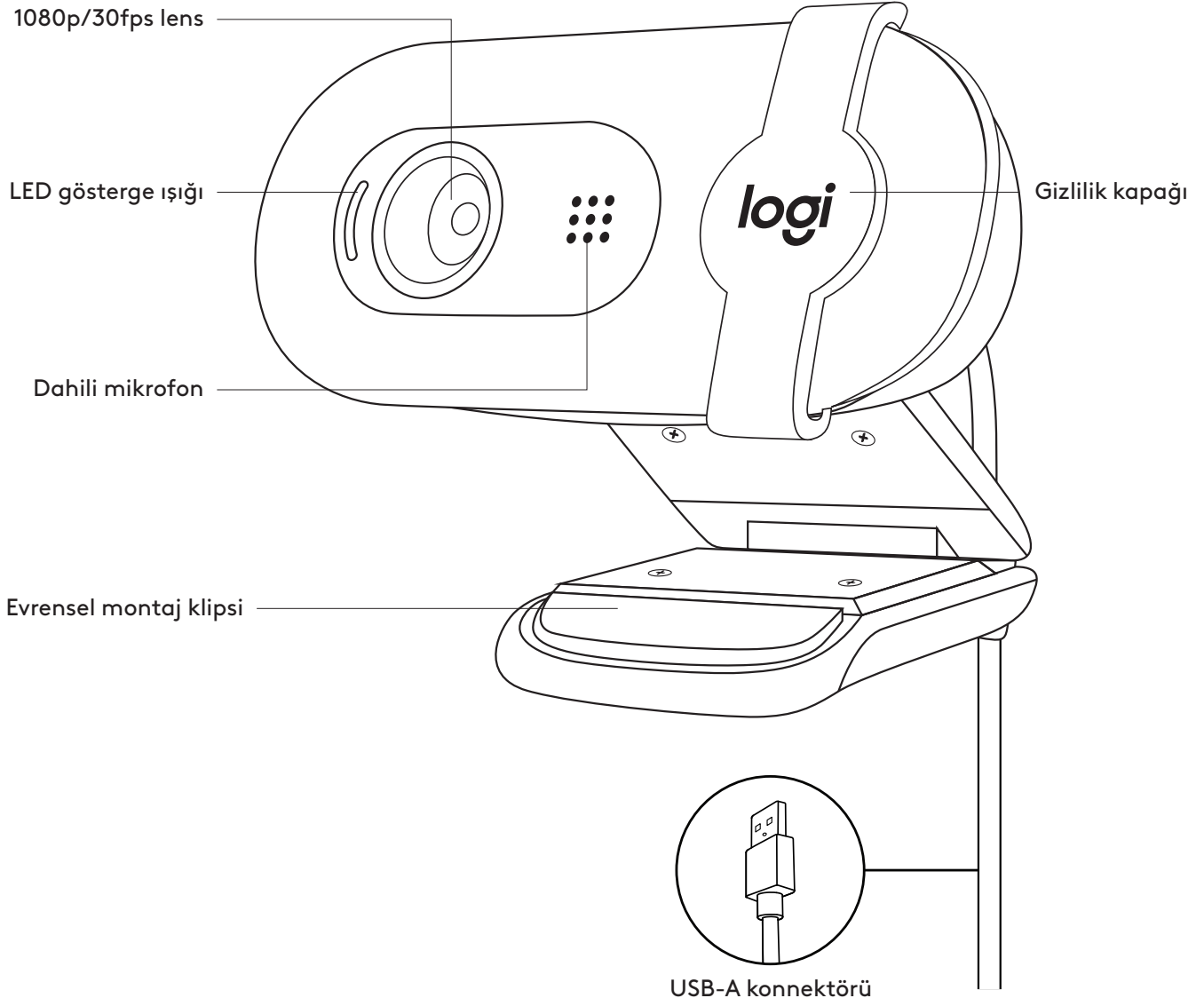

KUTUNUN İÇİNDEKİLER

- 1 2 m USB-A kabloya sahip web kamerası
- 2 Kullanıcı belgeleri

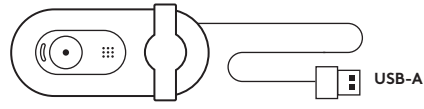

WEB KAMERASININ KURULUMU

Monitöre yerleştirmek için

- 1 Web kamerasını bir bilgisayara, dizüstü bilgisayara veya monitöre istediğiniz konum veya açıda yerleştirin.

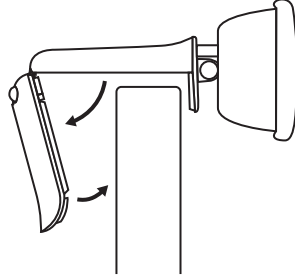

- 2 Evrensel montaj klipsi ucunun, cihazınızın arkasıyla aynı hizada olduğundan emin olacak şekilde web kamerasını ayarlayın.

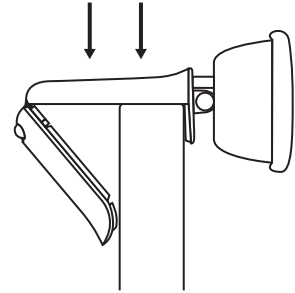

- 3 Kameranın görüş açısına tam olarak girdiğinizden emin olmak için web kamerasını elinizle aşağı veya yukarı doğru eğin.

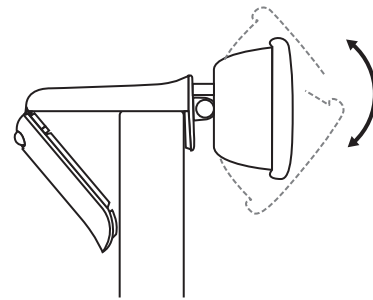

WEB KAMERASININ USB-A İLE BAĞLANMASI

USB-A konektörünü bilgisayarınızda karşılık gelen bağlantı noktasına takın.

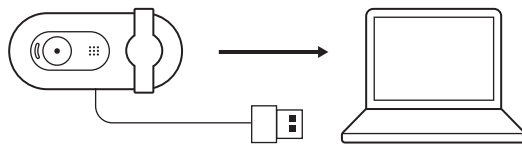

BAŞARILI BAĞLANTI

LED ışığın yanması kameranın açık olduğu ve bir uygulama tarafından kullanıldığı anlamına gelir.

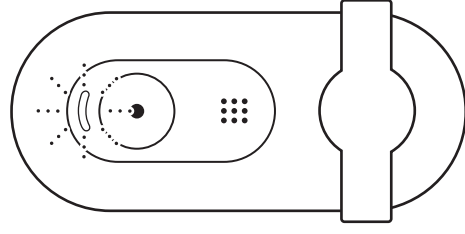

Gizlilik kapağını soldan sağa dek yavaşça kaydırarak açın. Gizlilik kapağının dahili mikrofonun üzerine gelmediğinden emin olun.

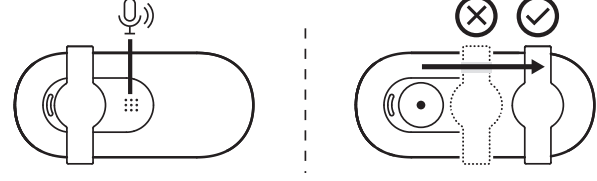

BOYUTLAR

WEBCAM:

Yükseklik x Genişlik x Derinlik:

31,91 mm (1,26 inç) x 72,91 mm (2,87 inç) x 66,64 mm (2,62 inç)

Ağırlık: 75 g (2,65 oz)

www.logitech.com/support/Brio100

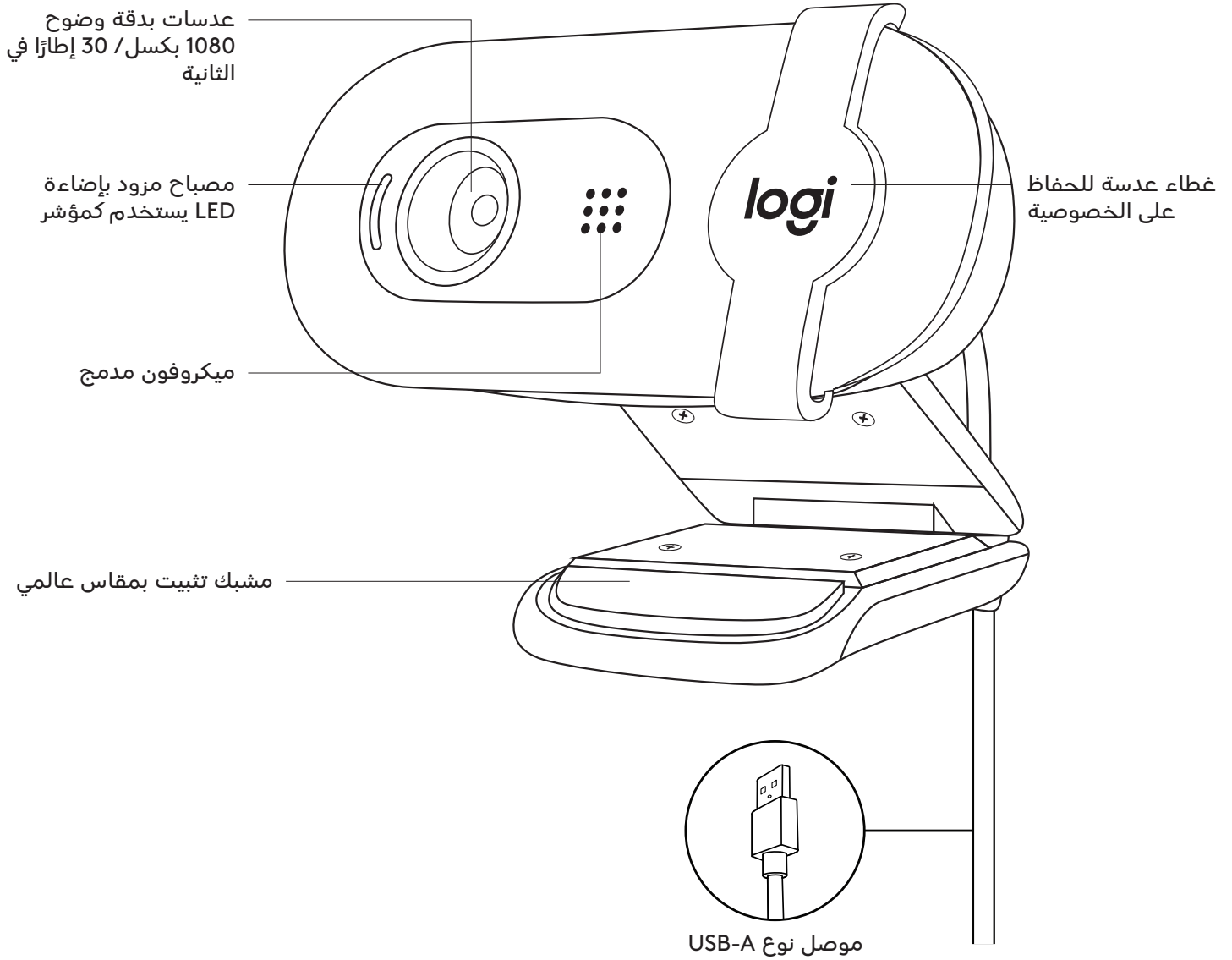

محتويات العبوة

- 1 كاميرا ويب مزودة بكابل USB-A بمقاس طول 7 أقدام (2 متر)
- 2 وثائق المستخدم

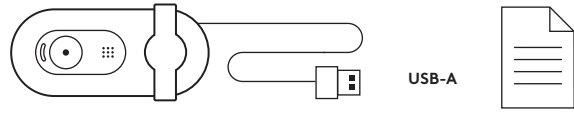

إعداد كاميرا الويب

بالنسبة للوضع على الشاشة

- 1 ضع كاميرا الويب على جهاز كمبيوتر أو كمبيوتر محمول أو شاشة في الموضع أو الزاوية التي تريدها.

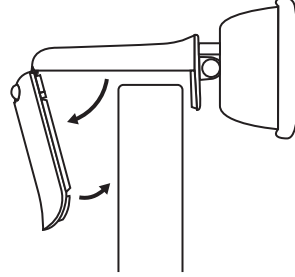

- 2 اضبط كاميرا الويب للتأكد من أن الطرف على مشبك التثبيت بمقاس عالمي متحاذاً مع الجزء الخلفي من جهازك.

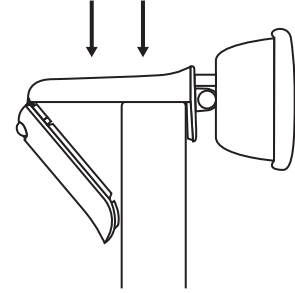

- 3 قم بإمالة كاميرا الويب يدويًا لأعلى أو لأسفل لتحديد إطارك داخل مجال رؤية الكاميرا.

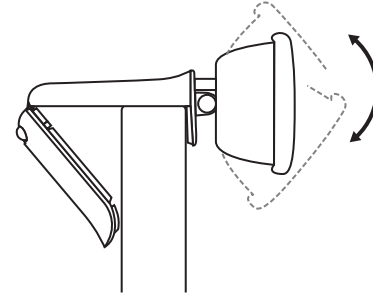

توصيل كاميرا الويب من خلال موصل من نوع USB-A

- قم بتوصيل موصل USB-A بالمنفذ المناسب على جهاز الكمبيوتر الخاص بك.

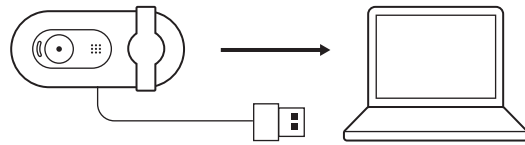

التوصيل الناجح

يشير المصباح بإضاءة (LED) إلى أن كاميرا الويب قيد التشغيل ويتم استخدامها من قبل تطبيق معين.

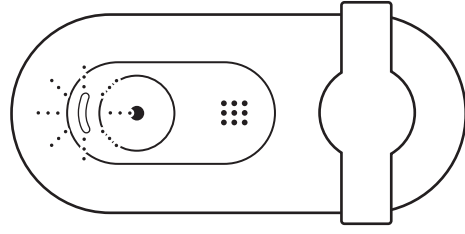

افتح غطاء العدسة للحفاظ على الخصوصية بإزالته بلطف من الجانب الأيسر إلى الجانب الأيمن. تأكد من عدم تغطيته للميكروفون المدمج.

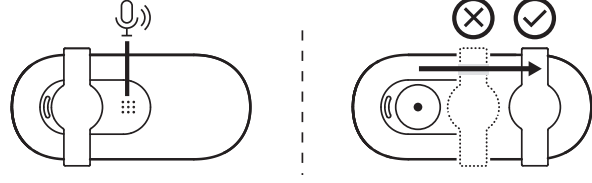

الأبعاد

كاميرا ويب

الطول × العرض × العمق:
1.26 بوصة (31.91 ملم) × 2.87 بوصة (72.91 ملم) × 2.62 بوصة (66.64 ملم)
الوزن: 2.65 أونصة (75 جم)

www.logitech.com/support/Brio100

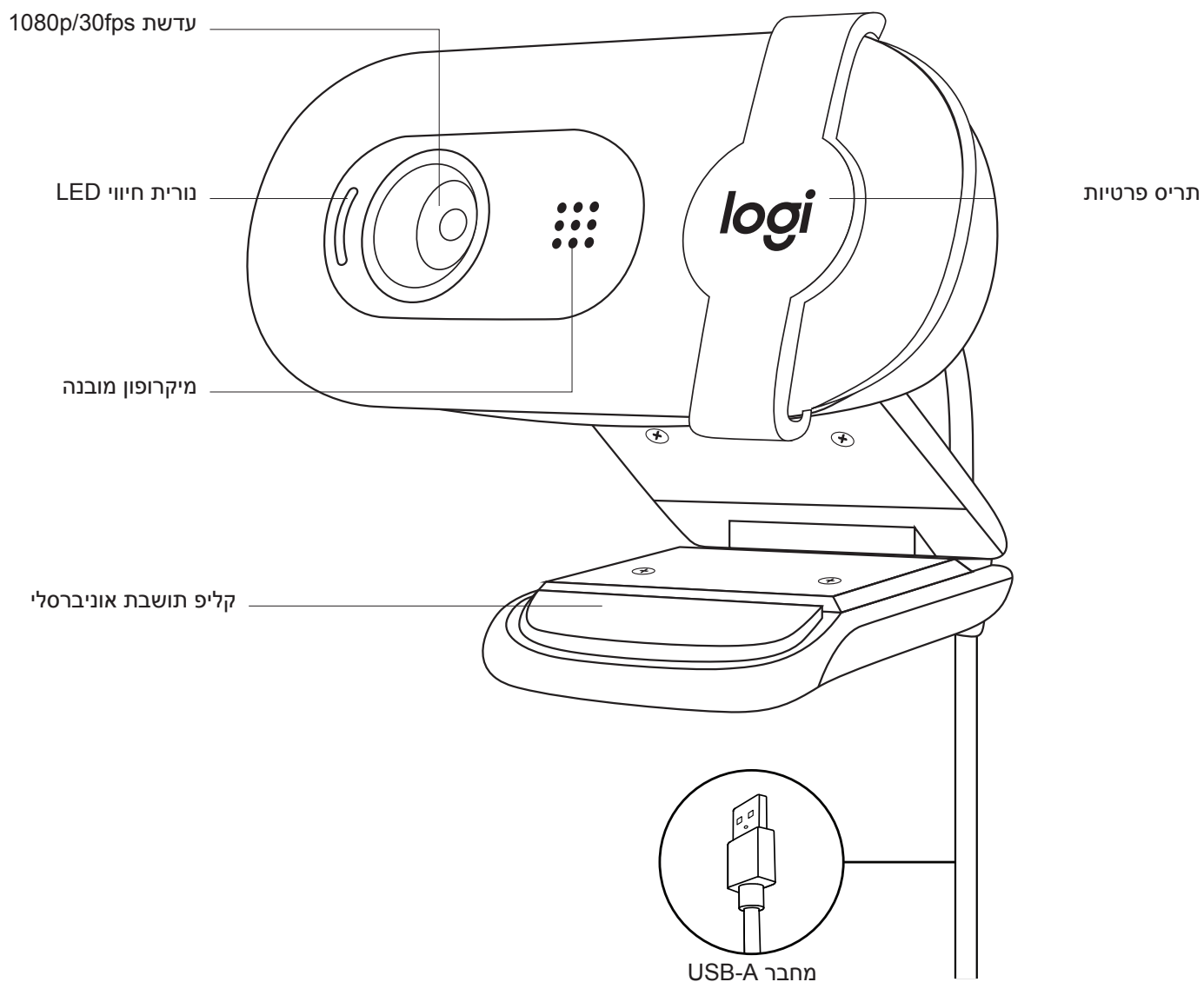

מה בקופסה?

- 1 מצלמת רשת עם כבל USB-A באורך 2 מ' מצורף
- 2 תיעוד למשתמש

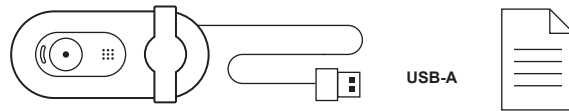

הגדרת מצלמת הרשת

למיקום המצלמה על מסך

- 1 מקם את מצלמת הרשת על המחשב, המחשב הנייד או המסך במיקום זווית רצויה.

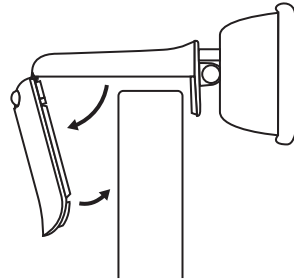

- 2 כוונן את מצלמת הרשת על מנת לוודא כי קצה קליפ התושבת האוניברסלי מיושר עם גב המכשיר.

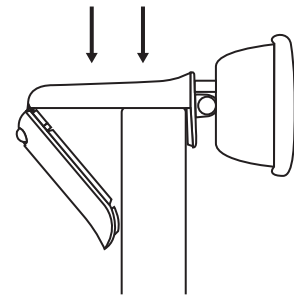

- 3 הטה ידנית כלפי מעלה או מטה את מצלמת הרשת על מנת שתוכל לראות את עצמך במסגרת בתוך תצוגת המצלמה.

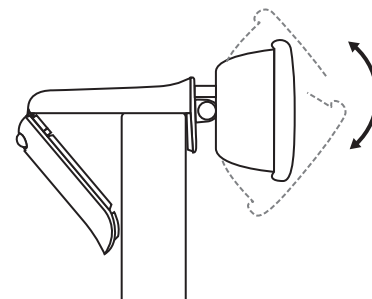

חיבור המצלמה עם USB-A

חבר את מחבר ה-USB-A ליציאה המתאימה במחשב.

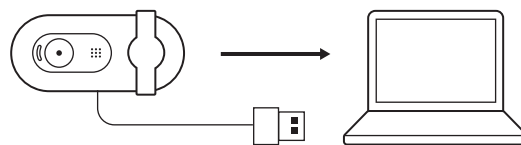

חיבור מוצלח

נורית LED נדלקת כאשר מצלמת הרשת פועלת ונמצאת בשימוש על ידי אפליקציה.

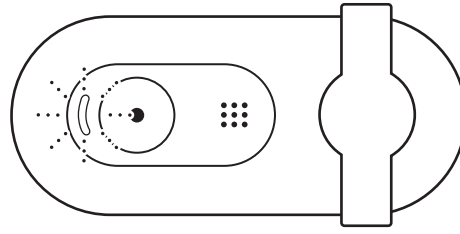

פתח את תריס הפרטיות על ידי החלקה עדינה שלו משמאל עד הסוף ימינה. וודא כי אינו מכסה את המיקרופון המובנה.

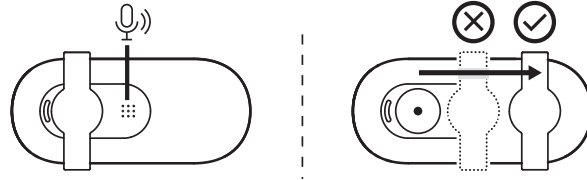

מידות

מצלמת אינטרנט:

גובה x רוחב x עומק:
31.91 מ"מ x 72.91 מ"מ x 66.64 מ"מ

משקל: 75 גר'

www.logitech.com/support/Brio100

瞭解您的產品

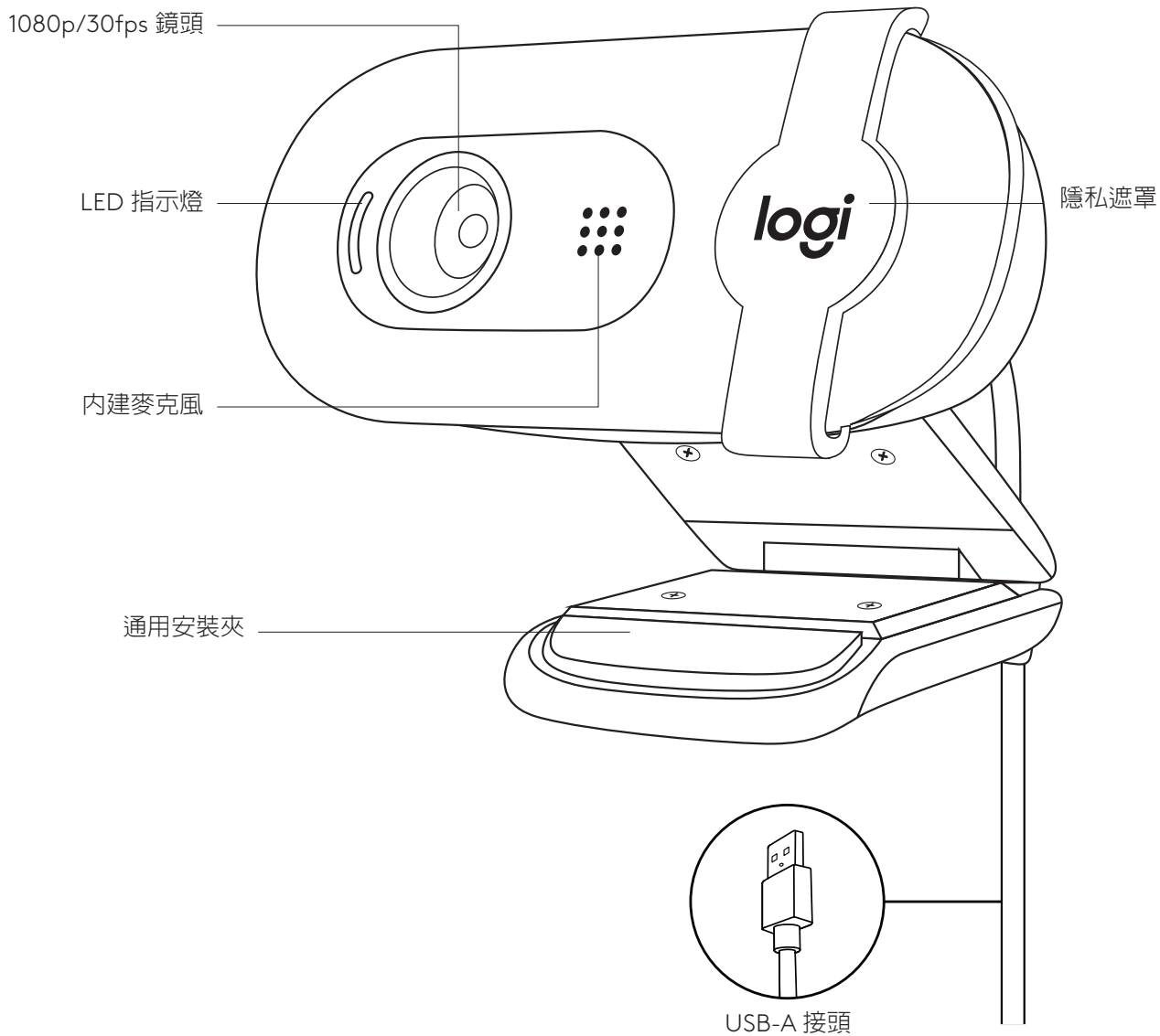

包裝內容

- 1 含 2 公尺 (7 英尺) USB-A 連接線的網路攝影機
- 2 使用者文件

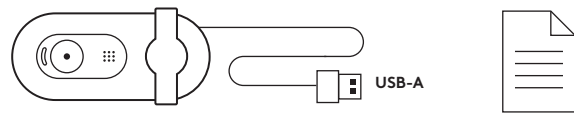

設定網路攝影機

放在螢幕上

- 1 將網路攝影機放到電腦、筆記型電腦或顯示器上您要的位置或角度。

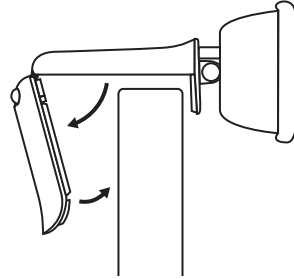

- 2 調整網路攝影機，確認通用安裝夾的末端與您的裝置背面齊平。

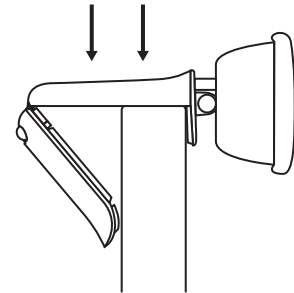

- 3 手動向上或向下傾斜網路攝影機，以在攝影機視野內取景您自己。

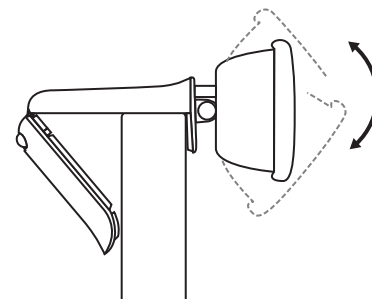

透過 USB-A 連接網路攝影機

將 USB-C 接頭插入到電腦上對應的連接埠。

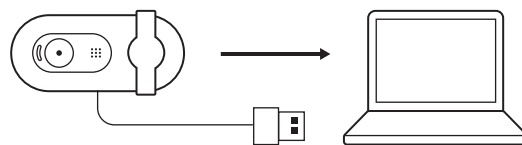

成功連接

LED 指示燈會表明網路攝影機已開啓電源，且正由應用程式使用。

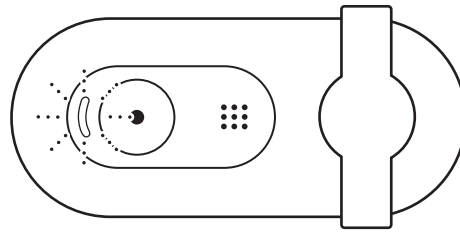

從左到右輕輕滑動隱私遮罩到底，將其打開。確認其沒有蓋住內建麥克風。

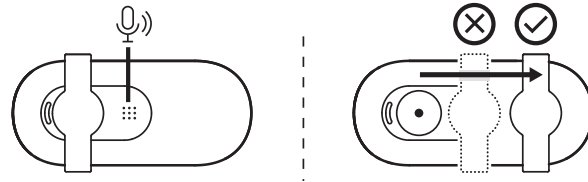

尺寸

網路攝影機：

高 x 寬 x 深：

31.91 公釐 (1.26 英吋) x 72.91 公釐 (2.87 英吋) x 66.64 公釐 (2.62 英吋)

重量：75 公克 (2.65 盎司)

www.logitech.com/support/Brio100

제품 설명

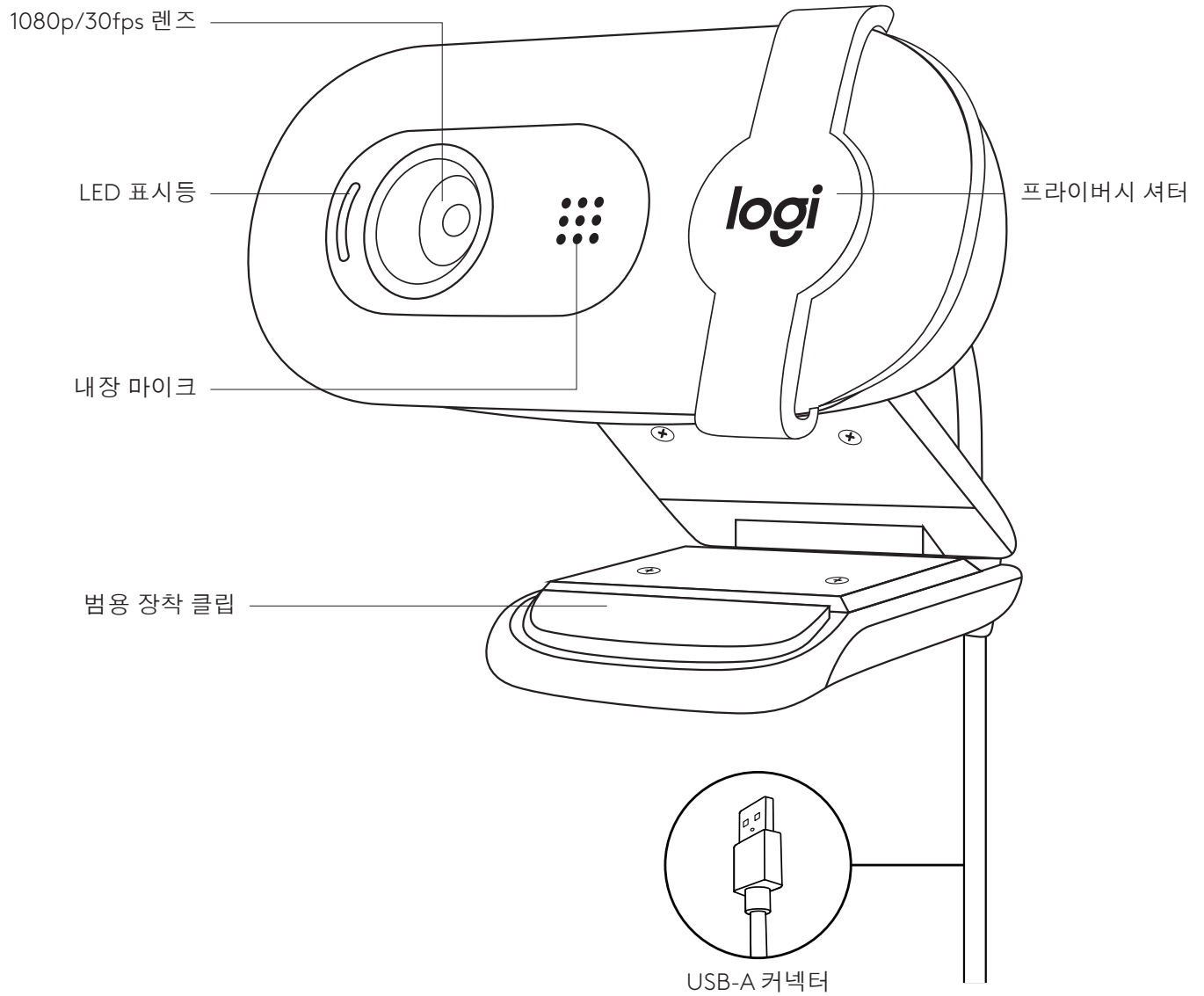

내용물

- 1 2m(7피트) USB-A 케이블이 부착된 웹캠
- 2 사용 설명서

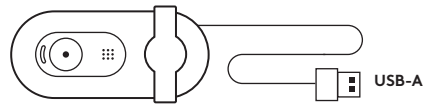

웹캠 설정

모니터에 배치할 경우

- 1 컴퓨터 위, 노트북, 모니터 등 원하는 위치 및 각도에 웹캠을 거치합니다.

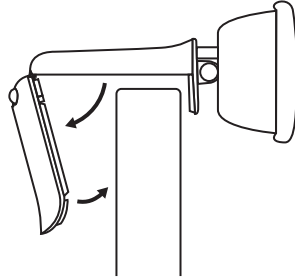

- 2 웹캠을 조절하여 거치할 장치의 후면과 범용 장착 클립의 끝이 평행을 이루게 합니다.

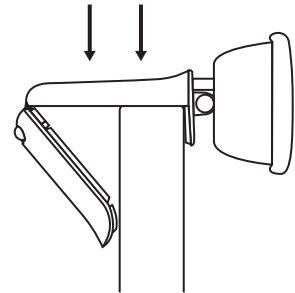

- 3 웹캠을 수동으로 위아래로 기울여 카메라 시야 내에서 자신의 구도를 잡습니다.

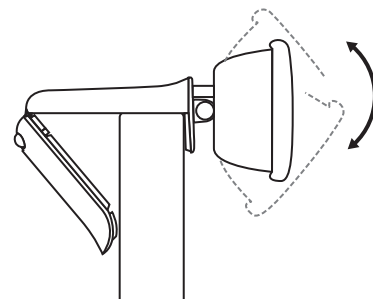

USB-A로 웹캠 연결

USB-A 커넥터를 컴퓨터의 해당 포트에 연결합니다.

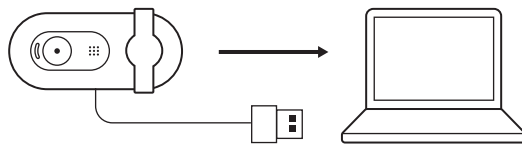

연결 성공

LED 표시등은 웹캠이 켜져 있고 응용 프로그램에서 사용 중임을 나타냅니다.

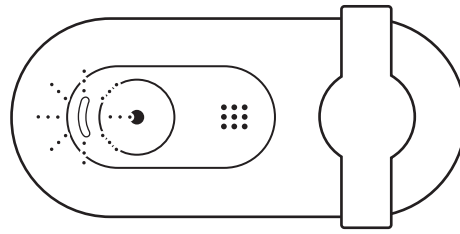

프라이버시 셔터를 왼쪽에서 오른쪽 끝까지 부드럽게 밀어 엽니다. 내장 마이크를 가리지 않도록 하십시오.

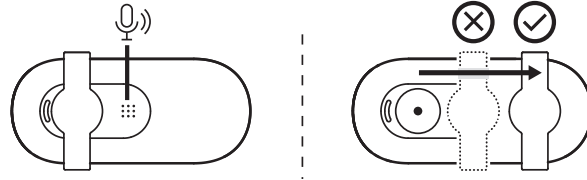

규격

웹캠:

높이 x 너비 x 깊이:
31.91mm(1.26인치) x 72.91mm(2.87인치) x 66.64mm(2.62인치)
무게: 75g(2.65oz)

www.logitech.com/support/Brio100

MENGENAL PRODUK

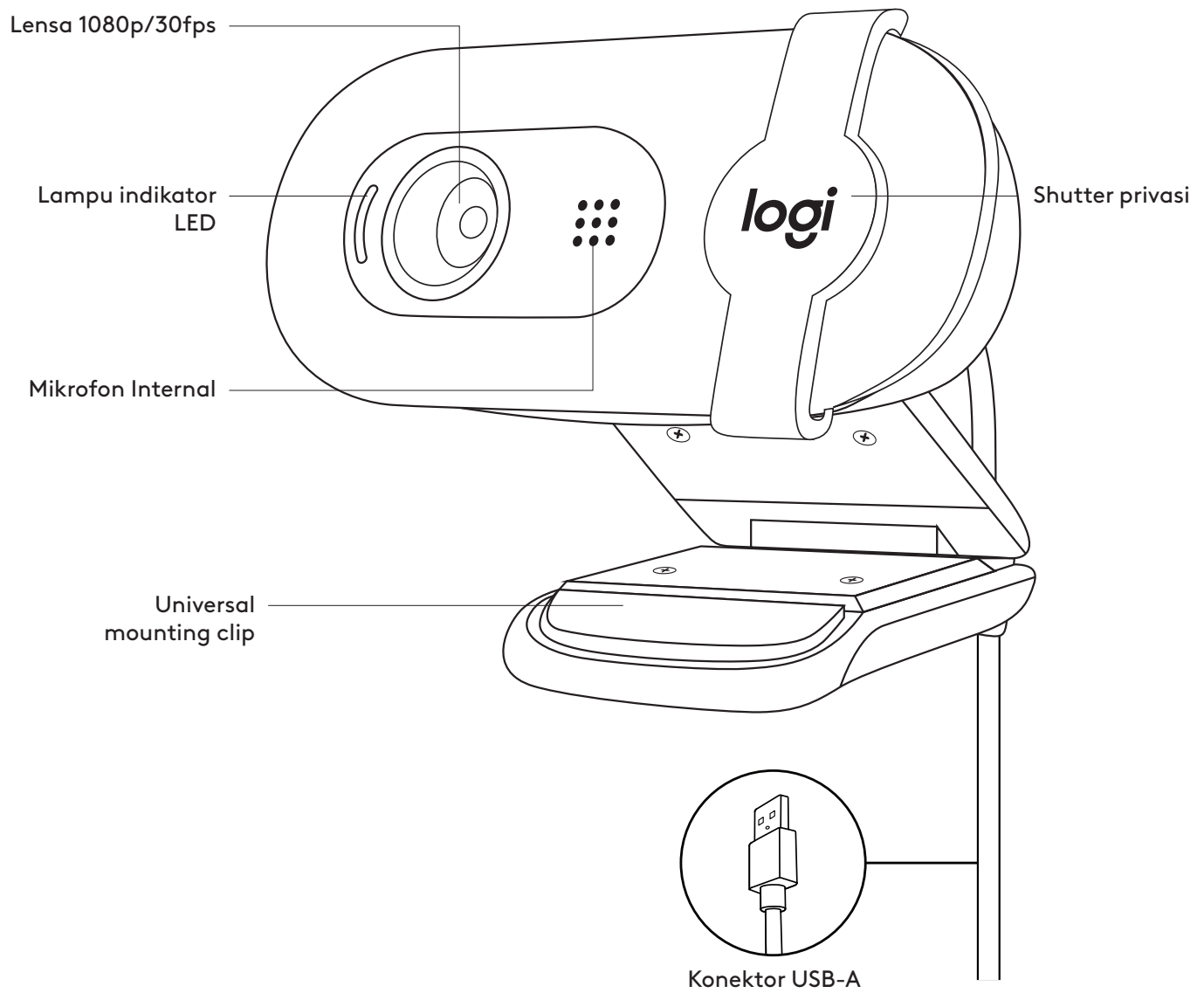

ISI KEMASAN

- 1 Webcam dengan kabel USB-A 7 kaki (2 m) terpasang
- 2 Dokumentasi pengguna

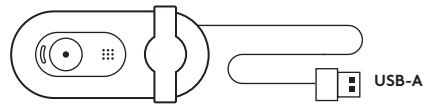

MEMASANG WEBCAM

Untuk penempatan di atas layar

- 1 Letakkan webcam Anda di komputer, laptop, atau layar pada posisi atau sudut yang Anda inginkan.

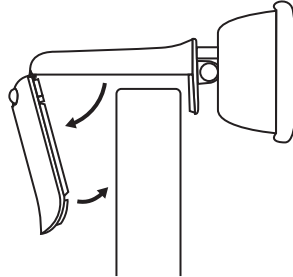

- 2 Sesuaikan webcam untuk memastikan ujung universal mounting clip terpasang erat dengan bagian belakang perangkat Anda.

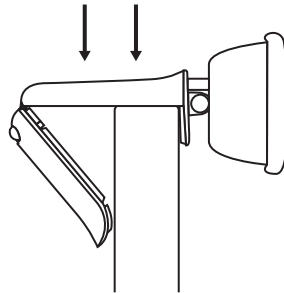

- 3 Miringkan webcam secara manual ke atas atau ke bawah untuk menempatkan diri Anda dalam bidang pandang kamera.

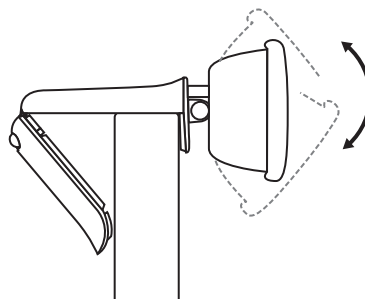

MENGHUBUNGKAN WEBCAM VIA USB-A

Colokkan konektor USB-A ke port yang sesuai di komputer Anda.

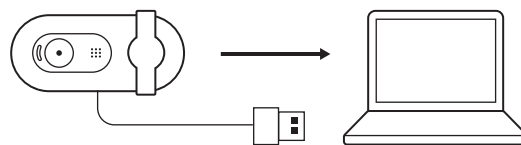

KONEKSI BERHASIL

Lampu LED menunjukkan kapan webcam sedang aktif dan digunakan oleh sebuah aplikasi.

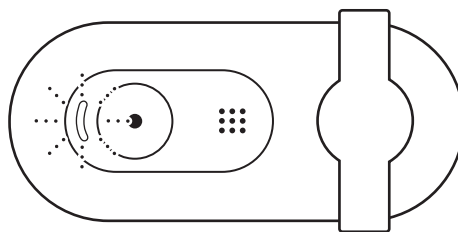

Buka shutter privasi dengan menggesernya perlahan dari kiri ke kanan. Pastikan shutter tidak menutupi mikrofon internal.

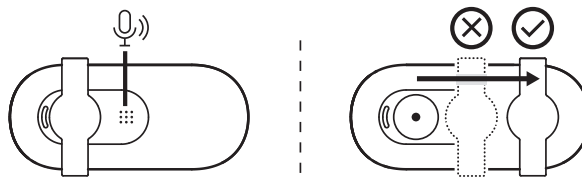

DIMENSI

WEBCAM:

Tinggi x Lebar x Tebal:

1,26 inci (31,91 mm) x 2,87 inci (72,91 mm) x 2,62 inci (66,64 mm)

Berat: 2,65 oz (75 g)

www.logitech.com/support/Brio100