



# Setup Manual

## DuraVision® FDF2711W-IP

Color LCD Monitor

Software Version 5.2

### Important







Please read this “Setup Manual”, “Installation Manual”, and “Instruction Manual” carefully to familiarize yourself with safe and effective usage.

Please retain this manual for future reference.

- 
- For the latest product information including the “Setup Manual”, refer to our web site :  
[www.eizoglobal.com](http://www.eizoglobal.com)
-

## SAFETY SYMBOLS

This manual and this product use the safety symbols below. They denote critical information. Please read them carefully.

<p><b>WARNING</b></p>  Failure to abide by the information in a WARNING may result in serious injury and can be life threatening.	<p><b>CAUTION</b></p>  Failure to abide by the information in a CAUTION may result in moderate injury and/or property or product damage.
	Indicates a warning or caution. For example,  indicates an “electrical shock” hazard.
	Indicates a prohibited action. For example,  means “Do not disassemble”.

## Related Manuals

<b>Setup Manual (this manual)</b>	Describes precautions and procedures for connecting network cameras and for displaying camera images on the monitor. (Installation and initialization guidance)
<b>Installation Manual*1</b>	Describes network camera registration, function settings, and system settings. (Detail settings guidance)
<b>Instruction Manual*1</b>	Describes operation of live image screen menus. (Operation guidance)

\*1 The Instruction Manual and Installation Manual for the latest software version used can be obtained from our web site. Select “Manuals” from “Support”, enter “FDF2711W-IP” in the “Enter model name” box, and click “Search”.

[www.eizo.com](http://www.eizo.com)

Installation of Adobe® Acrobat® Reader® is required.

This product has been adjusted specifically for use in the region to which it was originally shipped. If operated outside this region, the product may not perform as stated in the specifications.

No part of this manual may be reproduced, stored in a retrieval system, or transmitted, in any form or by any means, electronic, mechanical, or otherwise, without the prior written permission of EIZO Corporation. EIZO Corporation is under no obligation to hold any submitted material or information confidential unless prior arrangements are made pursuant to EIZO Corporation’s receipt of said information. Although every effort has been made to ensure that this manual provides up-to-date information, please note that EIZO monitor specifications are subject to change without notice.

# PRECAUTIONS

## IMPORTANT

To ensure personal safety and proper maintenance, please read carefully this section and the caution statements on the monitor.

### Location of the Caution Statements

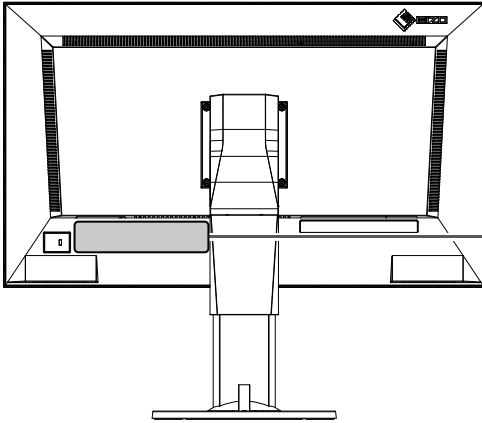

  
**WARNING**  
 RISK OF ELECTRIC SHOCK. DO NOT OPEN.

**AVERTISSEMENT**  
 RISQUE DE CHOC ELECTRIQUE. NE PAS OUVRIR.

**WARNUNG**  
 GEFAHR DES ELEKTRISCHEN SCHLAGES. RÜCKWAND NICHT ENTFERNEN.

**警告**  
 触电危険、請勿打开后盖。

**警告**  
 感電の恐れあり、カバーをあけないでください。

The equipment must be connected to a grounded main outlet.  
 L'appareil doit être relié à une prise avec terre.  
 Jordet stikkontakt skal benyttes når apparatet tilkobles datanett.  
 Apparaten skall anslutas till jordat nätuttag.  
 设备必须连接到接地地的电源插座。  
 電源コードのアースは必ず接地してください。

## **WARNING**

---

**If the unit begins to emit smoke, smells like something is burning, or makes strange noises, disconnect all power connections immediately and contact your local EIZO representative for advice.**

Attempting to use a malfunctioning unit may result in fire, electric shock, or equipment damage.

---

**Do not open the cabinet or modify the unit.**

Opening the cabinet or modifying the unit may result in fire, electric shock, or burn.



---

**Refer all servicing to qualified service personnel.**

Do not attempt to service this product yourself as opening or removing covers may result in fire, electric shock, or equipment damage.

---

**Keep small objects or liquids away from the unit.**

Small objects accidentally falling through the ventilation slots into the cabinet or spillage into the cabinet may result in fire, electric shock, or equipment damage. If an object or liquid falls/spills into the cabinet, unplug the unit immediately. Have the unit checked by a qualified service engineer before using it again.



---

**Place the unit at the strong and stable place.**

A unit placed on an inadequate surface may fall and result in injury or equipment damage. If the unit falls, disconnect the power immediately and ask your local EIZO representative for advice. Do not continue using a damaged unit. Using a damaged unit may result in fire or electric shock.

---

**Use the unit in an appropriate location.**

Not doing so may result in fire, electric shock, or equipment damage.

- Do not place outdoors.
- Do not place in a transportation system (ship, aircraft, train, automobile, etc.) where it may be affected by strong vibration or shock.
- Do not place in a dusty or humid environment.
- Do not place in environments with corrosive gases (such as sulfur dioxide, hydrogen sulfide, nitrogen dioxide, chlorine, ammonia, and ozone).
- Do not place in environments with dust, components that accelerate corrosion in the atmosphere (such as sodium chloride and sulfur), conductive metals, and so on.
- Do not place in a location where water is splashed on the screen (bathroom, kitchen, etc.).
- Do not place in a location where the steam comes directly on the screen.
- Do not place near heat generating devices or a humidifier.
- Do not place in a location where the product is subject to direct sunlight.
- Do not place in an inflammable gas environment.



---

**To avoid danger of suffocation, keep the plastic packing bags away from babies and children.**

---

**Check that the power cord you are using satisfies the following requirements**

This product does not include a power cord.

\* Please prepare a cord that conforms to the technical regulations of the country and region where the product is to be used.

- For Europe: Rating AC250V 10A, Cord type H05VV-F, GTCE-3, 0.75 mm<sup>2</sup>
- United States: Rating AC125V 10A, Cord type SVT, 3/18AWG (0.75 mm<sup>2</sup>)
- Japan: Rating AC125V 7A, Cord type VCTF, 0.75 mm<sup>2</sup>

**⚠ WARNING**

**To disconnect the power cord, grasp the plug firmly and pull.**

Tugging on the cord may damage and result in fire or electric shock.

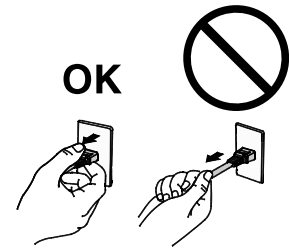

**The equipment must be connected to a grounded main outlet.**

Failure to do so may result in fire or electric shock.



**Use the correct voltage.**

- The unit is designed for use with a specific voltage only. Connection to another voltage than specified in this User's Manual may cause fire, electric shock, or equipment damage.
- Do not overload your power circuit, as this may result in fire or electric shock.

**Handle the power cord with care.**

- Do not place the cord underneath the unit or other heavy objects.
- Do not pull on or tie the cord.

If the power cord becomes damaged, stop using it. Use of a damaged cord may result in fire or electric shock.



**Never touch the plug and power cord if it begins to thunder.**

Touching them may result in electric shock.



**When attaching an arm stand, please refer to the user's manual of the arm stand and install the unit securely.**

Otherwise, the unit may become detached, resulting in injury and/or equipment damage. If the unit falls, please ask your local EIZO representative for advice. Do not continue using a damaged unit. Using a damaged unit may result in fire or electric shock. When reattaching the tilt stand, please use the same screws and tighten them securely.

**Do not touch a damaged LCD panel directly with bare hands.**

The liquid crystal that may leak from the panel is poisonous if it enters the eyes or mouth.

If any part of the skin or body comes in direct contact with the panel, please wash thoroughly.

If some physical symptoms result, please consult your doctor.



## CAUTION

---

### **Handle with care when carrying the unit.**

Disconnect the power cord and cables when moving the unit. Moving the unit with the cord attached is dangerous. It may result in injury.

---

### **When carrying the unit, grasp and hold it firmly by the bottom as shown in the illustration on the right.**

Dropping the unit may result in injury or equipment damage.



### **Do not block the ventilation slots on the cabinet.**

- Do not place any objects on the ventilation slots.
- Do not install the unit in a place with poor ventilation or inadequate space.
- Do not use the unit laid down or upside down.

Blocking the ventilation slots prevents proper airflow and may result in fire, electric shock, or equipment damage.



### **Do not touch the plug with wet hands.**

Doing so may result in electrical shock.

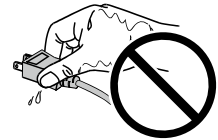

### **Use an easily accessible power outlet.**

This will ensure that you can disconnect the power quickly in case of a problem.

---

### **Periodically clean the area around the plug.**

Dust, water, or oil on the plug may result in fire.

---

### **Unplug the unit before cleaning it.**

Cleaning the unit while it is plugged into a power outlet may result in electric shock.

---

**If you plan to leave the unit unused for an extended period, disconnect the power cord from the wall socket after turning off the power for safety and power conservation.**

---

---

# Notice for this monitor

## About the Usage of This Product

This product is suited for displaying surveillance camera images.

When using the product in an application where extremely high reliability and safety are required as mentioned below, take measures to secure safety before using it.

- Transportation equipment (vessels, aircraft, trains, automobiles, etc.)
- Various safety devices such as disaster prevention devices and crime prevention devices
- Equipment and instruments that are directly associated with human life (medical instruments such as life support systems or the equipment used in the operating room)
- Nuclear control devices (nuclear control systems, safety protection systems used at nuclear power facilities, etc.)
- Main communication equipment (operation control systems for transportation systems, air traffic control systems, etc.)

This product may not be covered by warranty for uses other than those described in this manual.

The specifications noted in this manual are only applicable when using a power cord and signal cables which are specified by us.

Only use optional products manufactured or specified by us with this product.

## About the LCD Panel

The LCD panel is manufactured using high-precision technology. Although, missing pixels or lit pixels may appear on the LCD panel, this is not a malfunction. Percentage of effective dots: 99.9994 % or higher.

It takes about 30 minutes (under our measurement conditions) for the monitor display to stabilize. Please wait 30 minutes or more after the monitor power has been turned on, and then adjust the monitor.

Monitors should be set to a lower brightness to reduce changes in luminosity caused by long-term use and maintain a stable display.

When the screen image is changed after displaying the same image for extended periods of time, an afterimage may appear. Depending on the image, an afterimage may appear even if it was displayed for a short period of time. To remove such a phenomenon, change the image or keep the power turned off for several hours.

The backlight of the LCD panel has a fixed lifetime. When the screen becomes dark or begins to flicker, please contact your local EIZO representative.

Do not press on the LCD panel or edge of the frame strongly, as this may result in display malfunctions, such as interference patterns, etc. If pressure is continuously applied to the LCD panel surface, the liquid crystal may deteriorate or the LCD panel may be damaged. (If the pressure marks remain on the panel, leave the monitor with a black or white screen. The symptom may disappear.)

Do not scratch or press on the LCD panel with any sharp objects, at this may result in damage to the LCD panel. Do not attempt to brush with tissues as this may scratch the panel.

## About the Installation

When installing the monitor in a rack, ensure that there is adequate space around the sides, back and top of the monitor.

When the monitor is cold and brought into a room or the room temperature goes up quickly, dew condensation may occur on the interior and exterior surfaces of the monitor. In that case, do not turn the monitor on. Instead wait until the dew condensation disappears, otherwise it may cause some damage to the monitor.

If this product is placed on a lacquer-finished desk, the color may adhere to the bottom of the product due to the composition of the rubber.

## Cleaning

Periodic cleaning is recommended to keep the monitor looking new and to prolong its operation lifetime (For details, refer to the Instruction Manual.).

## Disclaimer

Our company shall bear no responsibility for any damage (including lost profits, etc.) incurred directly or indirectly by using this product or by malfunctions, etc. (including, but not limited to, those caused by the following).

1. Misuse or carelessness by the customer
2. Disassembly, repair, or modification by the customer
3. Inability to display images due to some reason or cause including malfunction or failure of this product
4. Use of the product in combination with a third-party device
5. Occurrence of an event such as infringement of privacy due to some cause with respect to the images monitored by the customer
6. Loss of registered or recorded information due to some cause

While this product displays camera surveillance images, the use of this product alone does not directly prevent crime.

## Network Security Request

Because this product is used by connecting to networks, the following risks apply

1. Leakage of information through this product.
2. Unauthorized operation of this product by a malicious third party.
3. Interference or suspension of the use of this product by a malicious third party.

In order to prevent the above described damage, it is the user's responsibility to implement adequate network security measures including the measures described below.

- Use this product with a safety-ensured network by using a firewall or other network security systems.
- Change the administrator password periodically.



# CONTENTS

<b>PRECAUTIONS</b> .....	<b>3</b>
<b>IMPORTANT</b> .....	<b>3</b>
<b>Notice for this monitor</b> .....	<b>7</b>
<b>About the Usage of This Product</b> .....	<b>7</b>
<b>About the LCD Panel</b> .....	<b>7</b>
<b>About the Installation</b> .....	<b>8</b>
<b>Cleaning</b> .....	<b>8</b>
<b>Disclaimer</b> .....	<b>8</b>
<b>Network Security Request</b> .....	<b>8</b>
<b>CONTENTS</b> .....	<b>9</b>
<b>Package Contents</b> .....	<b>10</b>
<b>Controls and Functions</b> .....	<b>10</b>
<b>Setup</b> .....	<b>12</b>
<b>Connecting the Network Cameras</b> .....	<b>13</b>
<b>Connecting Operating Devices</b> .....	<b>14</b>
● <b>Connecting a USB Mouse or Keyboard</b> .....	<b>14</b>
<b>Turning On the Power</b> .....	<b>14</b>
● <b>Live Image Screen</b> .....	<b>15</b>
<b>Perform Initialization</b> .....	<b>16</b>
● <b>Log In</b> .....	<b>16</b>
● <b>Setting the Date and Time</b> .....	<b>17</b>
● <b>Performing Network Settings</b> .....	<b>18</b>
● <b>Registering Cameras</b> .....	<b>20</b>
● <b>Setting the Language</b> .....	<b>23</b>
<b>Reference</b> .....	<b>24</b>
<b>Confirming the Software Version</b> .....	<b>24</b>
<b>Installation of Optional Arm</b> .....	<b>24</b>
● <b>Installation</b> .....	<b>25</b>
<b>Connecting HDMI Devices</b> .....	<b>25</b>
<b>Specifications</b> .....	<b>26</b>
<b>Troubleshooting</b> .....	<b>28</b>
<b>The screen is not displayed</b> .....	<b>28</b>
<b>Imaging Problems</b> .....	<b>29</b>
<b>Setting Problems</b> .....	<b>30</b>
<b>Other Problems</b> .....	<b>31</b>
<b>Appendix</b> .....	<b>32</b>
<b>License</b> .....	<b>32</b>
<b>Warning for Radio interference</b> .....	<b>33</b>
<b>LIMITED WARRANTY</b> .....	<b>34</b>
<b>Recycling Information/Informationen zum Thema Recycling/Informations sur le recyclage/Сведения по утилизации</b> .....	<b>i</b>

# Package Contents

Check that all of the following parts are included. If any of these are missing or damaged, contact your dealer or local EIZO representative.

- Monitor Unit
- Contact Addresses
- Setup Manual (this manual)

## Attention

- No power cord is supplied with this product. Use a power cord that complies with the rating and standards of the country or region where this product is used.

## Note

- It is recommended that the packing box and materials be kept for future usage such as for moving or transporting the product.

# Controls and Functions

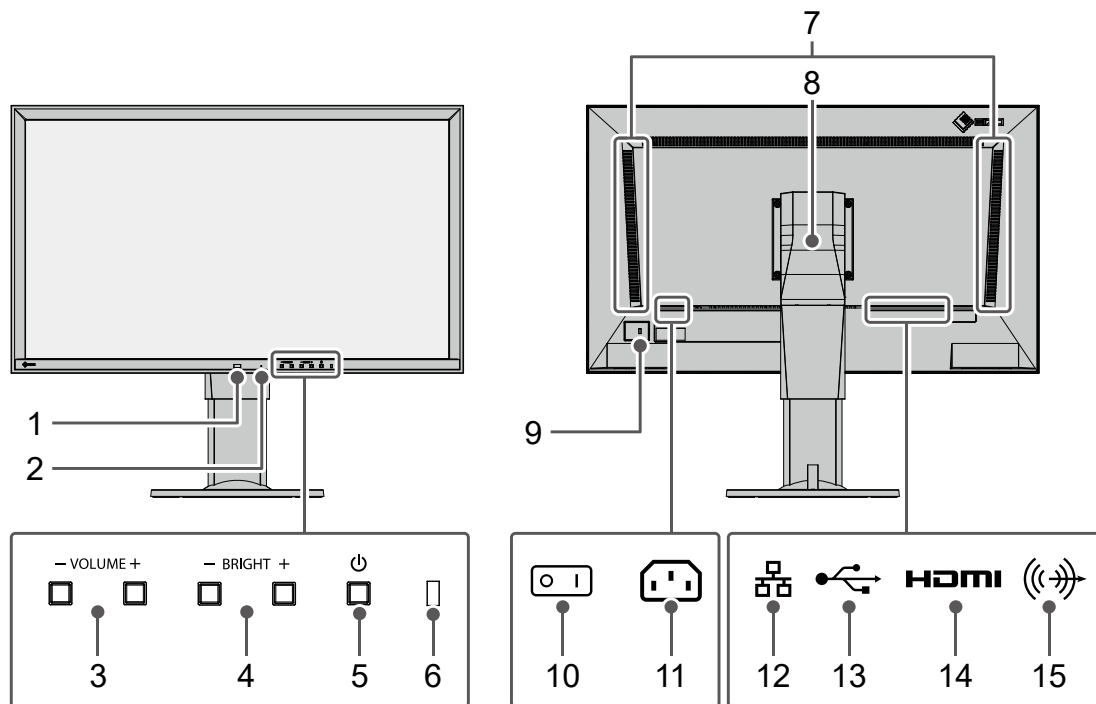

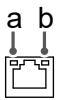
Names	Details			
1. Remote control light reception section	Receives signals from the remote control. (A function for use with models equipped with a remote control)			
2. Reset button	Pressing and holding this button for 10 seconds will initialize the following information: <ul style="list-style-type: none"> <li>• Camera information</li> <li>• USB lock</li> <li>• User account setting</li> </ul>			
3. VOLUME- / VOLUME+ buttons	Cannot be used.*1			
4. BRIGHT- / BRIGHT+ buttons	Adjusts the brightness of the monitor screen. By pressing and holding the button, you can quickly change the brightness.			
5. ⏻ button	Turns the power on or off.			
6. Power indicator	Displays the operating status of the monitor.			
	Blue	The screen is displayed.		
	Flashing blue	The system is starting up.		
	Red	Power off		
OFF	Main power off			
7. Speakers	Cannot be used.*1			
8. Stand*2	Adjusts the viewing angle. <b>Note</b> <ul style="list-style-type: none"> <li>• While the monitor can be rotated vertically, the live image screen menu will not be rotated.</li> </ul>			
9. Security lock slot	Supports Kensington MicroSaver security system.			
10. Main power switch	Turns the main power on or off.  : On ○: Off			
11. Power connector	Connects the power cord.			
12. LAN port	Connects the network cable.			
		a) Status LED	OFF	Not used
		b) Link LED	Flashing green	Transmitting data
			OFF	No data transmission
13. USB downstream port	Connects a USB mouse or USB keyboard.*3			
14. HDMI connector (output)	Connects to an additional monitor that supports HDMI.			
15. Stereo mini jack	Cannot be used.*1			

\*1 Will be supported with updated software.

\*2 The stand of this product can be replaced by an optional arm (or optional stand). For details on how to replace the stand, refer to "Installation of Optional Arm" (page 24).

\*3 Other USB devices cannot be connected.

# Setup

Set up the system until network camera images are displayed on the monitor.  
This product is operated or set using a USB mouse or USB keyboard.

## Setup Flow

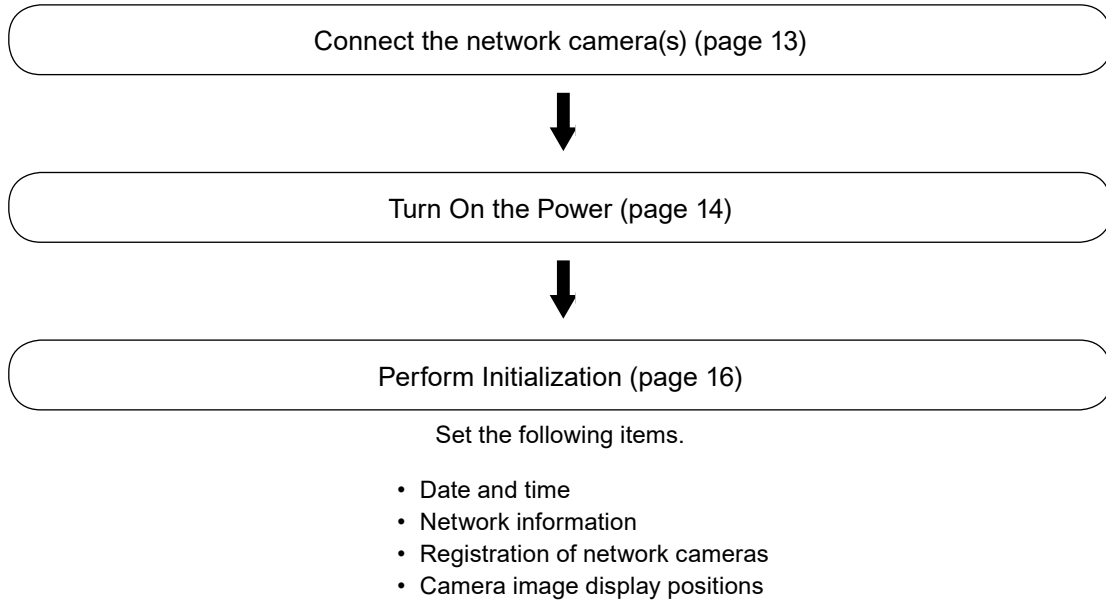

This completes the setup procedure.

---

**Attention**

- The language used in menus and messages displayed when the monitor is started differs according to the sales region.

---

**Note**

- Initial settings can be made from the Web browser of a computer connected to the same network. For details on setting from a Web browser, refer to the "Installation Manual".
-

# Connecting the Network Cameras

Connect the network camera and the monitor according to the following procedure.

## 1. Connect the network camera to the monitor via the network hub.

1. Connect the network cable (straight cable, Cat 5e or higher) to the monitor and the LAN port of the network hub.

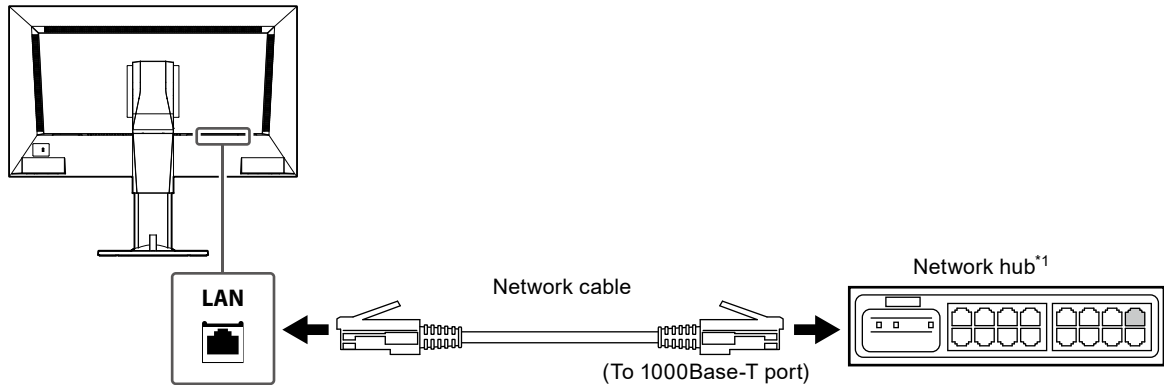

\*1 Use a hub compatible with 1000Base-T. For some network cameras, the hub must be compatible with the PoE function. Check the network camera's manual for information on the appropriate hub to use.

2. Connect the network cameras to the network hub.

For connecting the network cameras and the network hub, refer to the network camera User's Manual.

### Connection example

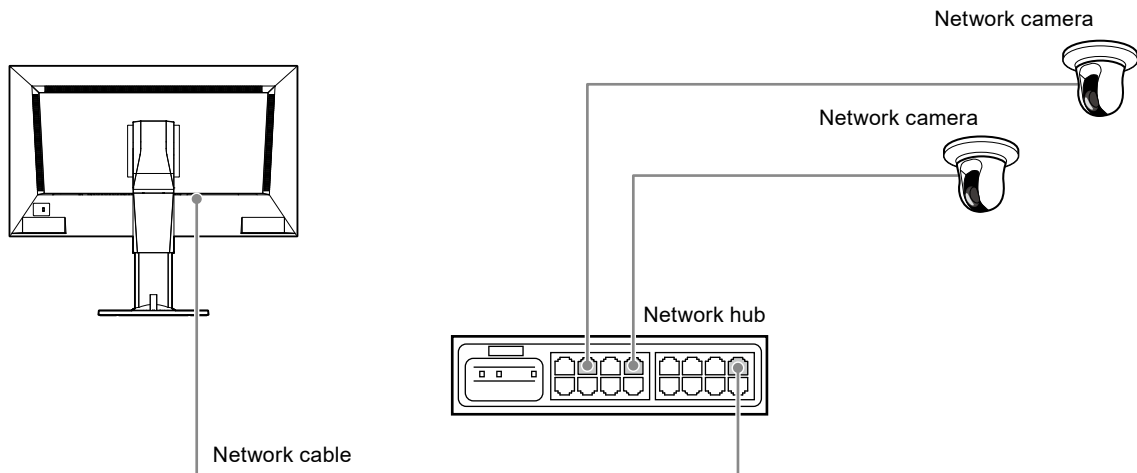

#### Note

- A maximum of 48 network cameras can be registered.

## 2. Connect the power cord to the power connector of the monitor and plug in the cord to the wall socket.

Insert the power cord all the way into the monitor.

#### Attention

- Do not bundle cables when wiring.

# Connecting Operating Devices

## ● Connecting a USB Mouse or Keyboard

Connect the mouse or keyboard to the USB downstream port at the back of the monitor.

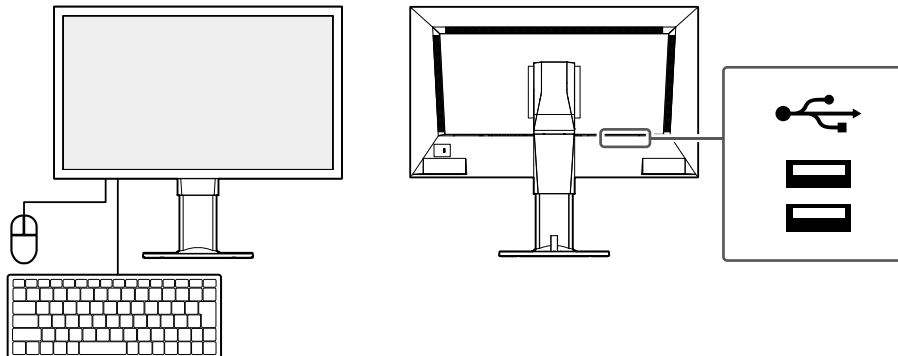

### Note

- Both the USB mouse and USB keyboard can be used.

# Turning On the Power

## 1. Turn on the main power switch on the back of the monitor.

The main power switch is turned on by factory settings.

## 2. Press on the front of the monitor.

The power indicator lights up blue and the live image screen is displayed.

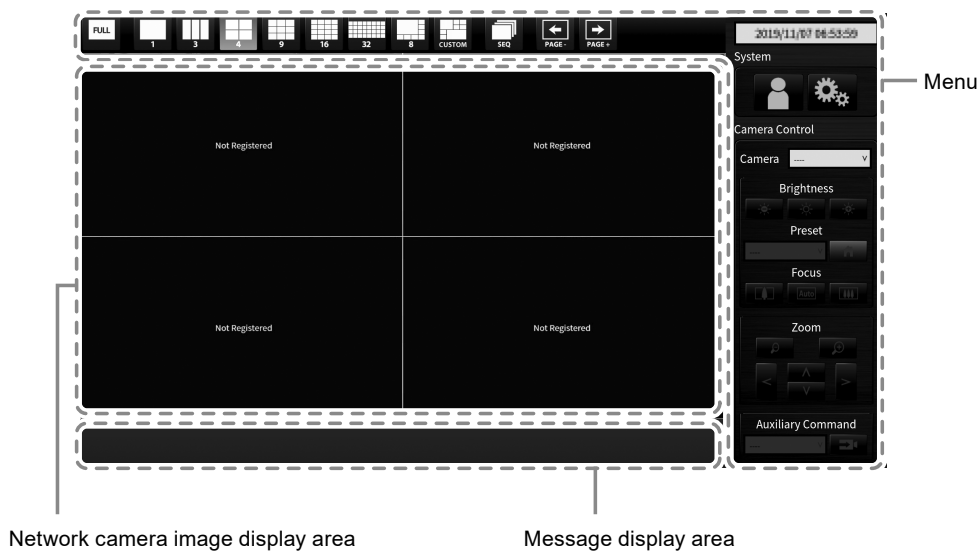

### Attention

- It takes approximately one minute for the live image screen to be displayed after the main power is turned on. (A rotating bar indicating startup is displayed.) Do not turn off the monitor during startup.
- When no network camera is registered, a "Not Registered" message is displayed in the network camera image display area.

### Note

- To turn off the power, press  on the front of the monitor.

## ● Live Image Screen

Describes basic operation of live image screen. For details, refer to the “Instruction Manual”.





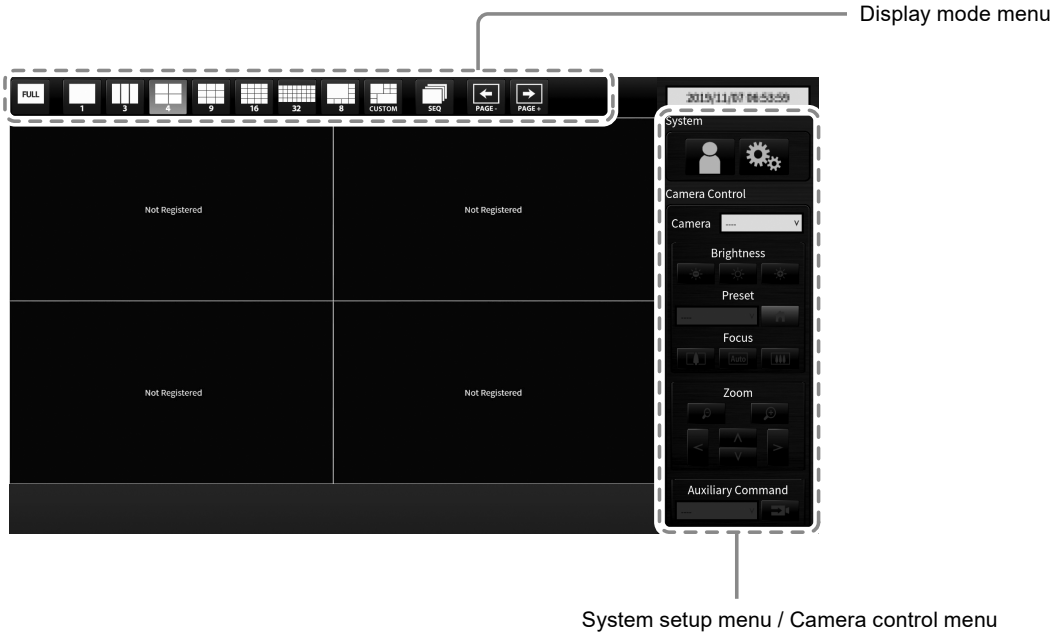







### Menu Operations

The various menus can be operated using a USB mouse or USB keyboard.  
If a menu is not displayed, click the screen with the USB mouse to display a menu.



### Display mode menu

Camera images displayed on the live screen can be operated.

Display mode menu	Shortcut key	Details
	F	Displays or hides the menu of the live image screen.
       	L	Changes the layout of the monitor screen. Each time the button is pressed, the layout changes in the following order: 1 Screen → 3 Screens → 4 Screens → 9 Screens → 16 Screens → 32 Screens → 8 Screens → Custom Screen → 1 Screen.
	S	Turns the sequence of the camera image (mode that switches the display page at regular intervals) on or off.
 	PageDown / PageUp	Changes the camera image page to display on the live image screen.

# Perform Initialization

This section describes settings to display network camera images on the monitor.

## Note

- Initial settings can be made from the Web browser of a computer connected to the same network.  
For details on setting from a Web browser, refer to the "Installation Manual".

## ● Log In

### 1. Select (Login).

The login screen is displayed.



### 2. Enter "Username" and "Password".

1. Enter the user name and password shown below and then press ENTER.

Username: "admin"

Password: "admin"

## Note

- The above user name and password are the default settings.

## Entering characters

- When entering using a USB mouse  
Clicking an item that requires characters to be input, such as a text box, will display a software keyboard.  
When the focus is moved out of the software keyboard, the software keyboard is hidden.



- When entering using a USB keyboard  
Entered characters are displayed in the text box.



### 3. Select “Login”.

The display returns to the live image screen where you can select  (Settings).



## ● Setting the Date and Time

### Attention

- Set the correct dates. Incorrect dates may result in failure of secure communication during certificate validation. If you use SSL for communication with the camera or LDAP setting, avoid the state of power turned off for a long time of period or make sure correct time is set using NTP.
- If secure LDAP communication is not established, you can not login. Reset the account setting using the Reset button.

### 1. Select (Settings).

The setting screen is displayed.

### 2. Select “Date and Time” under “System”.

The “Date and Time” screen is displayed.

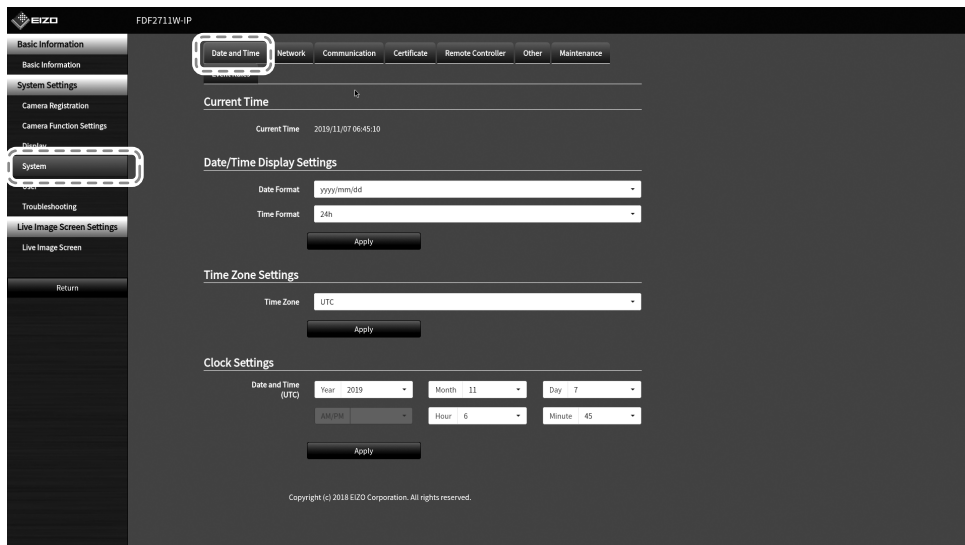

### 3. Set the current date and time.

#### Date/Time Display Settings

Item	Detail	Setting range
Date Format	Set the date format and time format.	yyyy/mm/dd, Mmm/dd/yyyy, dd/Mmm/yyyy, mm/dd/yyyy, dd/mm/yyyy
Time Format		

#### Time Zone Settings

Item	Detail	Setting range
Time Zone	Set the time zone.	Region / city

#### Clock Settings

Item	Detail	Setting range
Procedure <sup>*1</sup>	Select the time setting procedure.	Manual / Synchronize with PC
Date and Time	Set the current time.	2018/1/1 0:00 to 2035/12/31 23:59

\*1 This can be set only when displayed on the web browser.

### 4. Select “Apply”.

The Setting Complete screen will be displayed, so select “OK”.

#### Note

- When “Synchronize with PC” is selected for “Procedure”, the current date and time information of the computer is transmitted to this product.
- If the system is not connected to the power supply for one week or longer, the date and time displayed on the monitor will become incorrect. If such a situation occurs, reset the date and time.

## ● Performing Network Settings

### 1. Select (Settings).

The setting screen is displayed.

### 2. Select “Network” under “System”.

The “Network” screen is displayed.

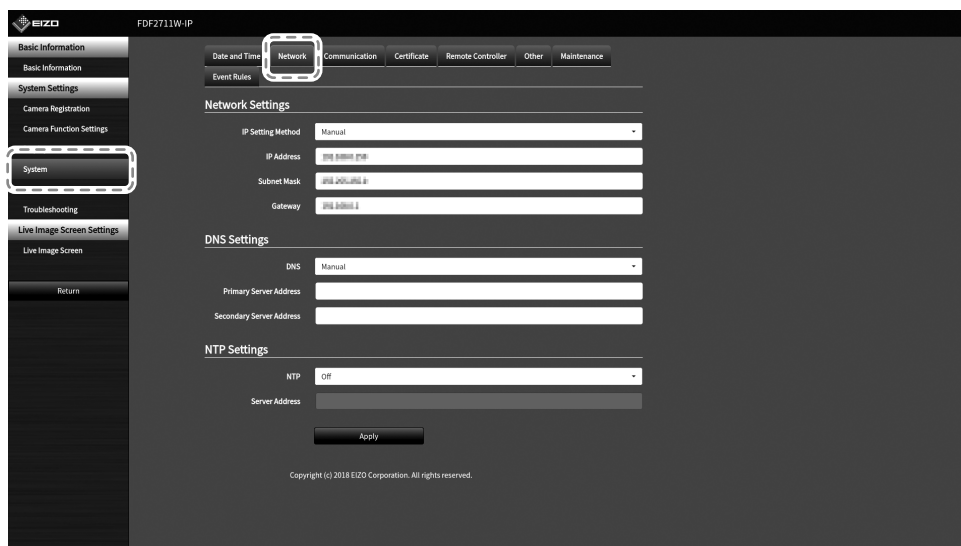

### 3. Set the following items.

#### Network Settings

Item	Detail	Setting range
IP Setting Method	Select an IP Setting Method.	DHCP / Manual
IP Address <sup>*1</sup>	When "Manual" is selected under "IP Setting Method", "IP Address", "Subnet Mask", and "Gateway" can be set.  <b>Attention</b> <ul style="list-style-type: none"> <li>• Avoid duplicate IP addresses for devices on the same network.</li> <li>• If multiple units of this product are connected on the same network, their IP addresses should be changed.</li> </ul>	0.0.0.0 to 255.255.255.255
Subnet Mask		
Gateway <sup>*2</sup>		

\*1 The initial address is "192.168.0.150".

\*2 If the environment does not include a gateway, it is not necessary to set "Gateway". Either leave it as default setting or set "0.0.0.0".

#### DNS Settings

Item	Detail	Setting range
DNS	(Only when "Manual" is selected under "IP Setting Method" of "Network Settings") Set "DNS".	Auto / Manual
Primary Server Address	When "Manual" is selected under "DNS", set "Primary Server Address" and "Secondary Server Address".	0.0.0.0 to 255.255.255.255
Secondary Server Address		

#### NTP Settings

Item	Detail	Setting range
NTP	Set whether to use the NTP server or not.	On / Off
Server Address	When "On" is selected, set the NTP server address.	Alphanumerics and symbols

For entering methods, refer to "Entering characters" (page 16).

### 4. Select "Apply".

The setting complete screen is displayed.

### 5. Select "OK".

## ● Registering Cameras

### 1. Start network cameras.

For setting the network cameras, refer to the network camera User's Manual.

### 2. Select (Settings).

The setting screen is displayed.

### 3. Select “Camera Registration”.

A screen is displayed to show a list of camera registration information.

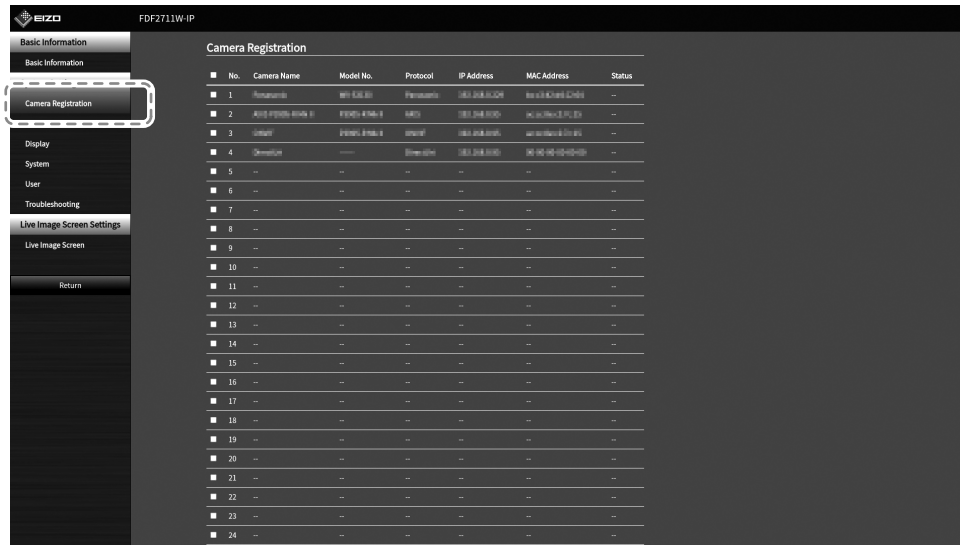

### 4. Select a position where the camera is to be registered.

Place a check mark on the check box of the position number where the camera is to be registered.

### 5. Select “Manual Registration”.

The “Camera Information Settings” dialog box is displayed.

#### Note

- Network cameras installed on the same network as the monitor can be automatically detected. For details, refer to the “Installation Manual”.

## 6. Set each item and select “OK”.

Item	Detail	Setting range
Camera Name <sup>*1</sup>	Enter the camera name. If "Obtain Camera Name" is selected, the camera name is automatically obtained from the network camera. <sup>*2</sup> <ul style="list-style-type: none"> <li>If "Protocol" is "DirectUri," "Obtain Camera Name" cannot be used.</li> </ul>	Alphanumeric, kana <sup>*3</sup> , kanji <sup>*3</sup> (Up to 24 characters)
IP Address	Enter the IP address of the network camera.	0.0.0.0 to 255.255.255.255
"Ping" button	Executes a connection test with the camera (i.e. ping command).	
Port	Enter the port number of the network camera.	1 to 65535 <sup>*4</sup>
SSL <sup>*5</sup>	Provides secure communication.	
Certificate Validation	Select certificate validation during SSL communication. <b>Attention</b> <ul style="list-style-type: none"> <li>If "Certificate Validation" is "On," the Root Certificate of the network camera must be registered in "Root Certificate" of "Certificate".</li> </ul>	On / Off
Protocol	Select the protocol to control cameras.	Panasonic / AXIS / ONVIF / DirectUri
Username <sup>*6</sup>	Enter the user name to be used to access the network camera.	Alphanumerics and symbols (Up to 32 characters)
Password <sup>*6</sup>	Enter the password to be used to access the network camera.	Alphanumerics and symbols (Up to 32 characters)
Media Profile <sup>*7</sup>	Select the media profile of the network camera. If "Obtain Profile" is selected, the profile is automatically obtained from the network camera.	EIZO_Profile / Profile of each camera
Transmission Mode <sup>*7</sup>	Select the mode for transmitting camera images.	Unicast / Multicast
URI <sup>*8</sup>	Set the URI that starts with rtsp:// or rtp://.	Alphanumerics (Up to 1023 characters)
Comm. Method	Select the communication method for camera video images.	RTP over UDP <sup>*9</sup> / RTP over RTSP
Stream <sup>*10</sup>	Select a stream format.	1 / 2 / 3 / 4
Channel <sup>*10</sup>	Select a stream channel.	1 / 2 / 3 / 4
RS485PTZ Control <sup>*10</sup>	Select whether or not PTZ operation is enabled for the camera that supports RS 485 communication.	On / Off
Video Stream <sup>*11</sup>	Select a video stream format.	Depends on the camera
Stream Profile <sup>*11</sup>	Select a stream profile.	Depends on the camera

- 
- \*1 Can only be acquired when "IP Address," "Port," "Username," and "Password" are entered.
  - \*2 If "Protocol" is "DirectUri," the "Obtain Camera Name" button is not displayed.
  - \*3 This can be used only when displayed on the Web browser.
  - \*4 When "Protocol" is set to "DirectUri" and "URI" starts with rtp://, the setting range will be 1024 to 65534.
  - \*5 Can only be set if "Protocol" is "Panasonic" or "AXIS".
  - \*6 Enter the username and password of the user who has the administrator's rights. For details, refer to the network camera User's Manual.
  - \*7 Can only be set if "Protocol" is "ONVIF".
  - \*8 Can only be set if "Protocol" is "DirectUri".
  - \*9 Only "RTP over UDP" can be set in the following situations.
    - When "Protocol" is "ONVIF," and "Transmission Mode" is "Multicast"
    - When "Protocol" is "DirectUri," and "URI" starts from rtp://
  - \*10 This can be set only when "Protocol" is set to "Panasonic".
  - \*11 Can only be set if "Protocol" is "AXIS".

Returns to the screen that shows a list of camera registration information in the step 3 above.

## 7. Select "Apply".

A confirmation message is displayed.

## 8. Select "OK".

---

### Note

- If there is a failure in obtaining "Obtain Camera Name" or "Obtain Profile" information, the following message is displayed. Check the settings again.

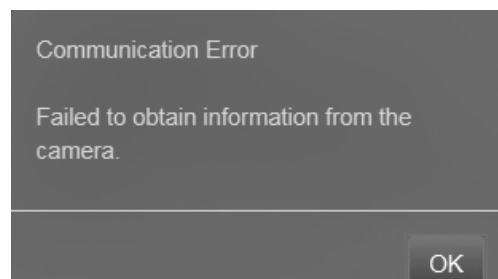

## ● Setting the Language

### 1. Select (Settings).

The setting screen is displayed.

### 2. Select “Other” under “System”.

The “Other” screen is displayed.

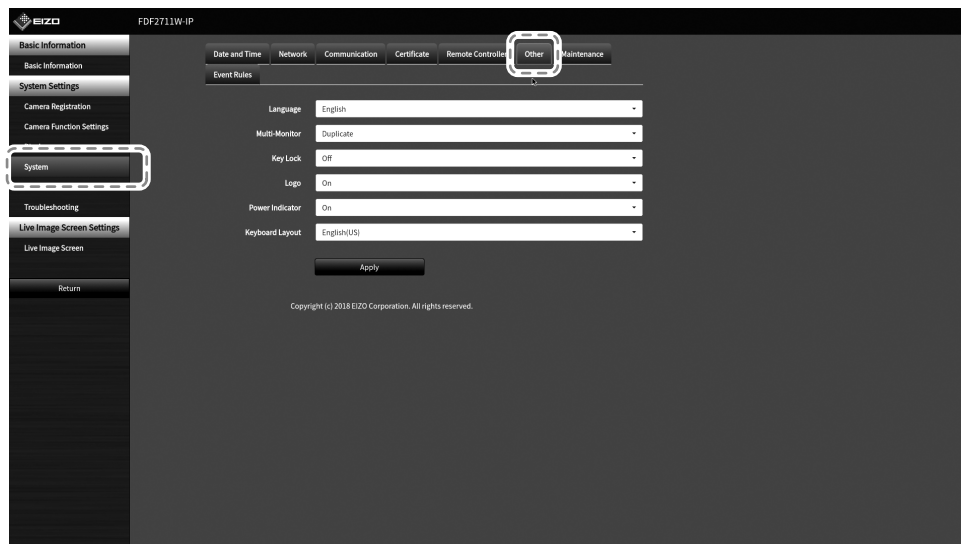

### 3. Select a language from the "Language" list box.

### 4. Select “Apply”.

The setting complete screen is displayed.

### 5. Select “OK”.

# Reference

## Confirming the Software Version

### 1. Select (Settings).

The setting screen is displayed.

### 2. Select “Basic Information”.

The current software version is displayed in the system information.

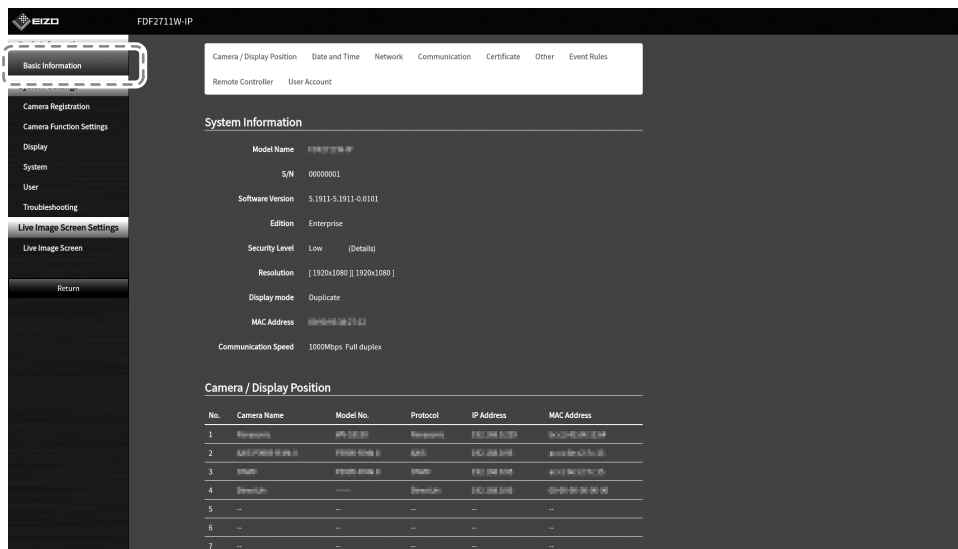

## Installation of Optional Arm

The stand of this product can be replaced by an optional arm (or optional stand). For details of supported optional arms (or optional stands), refer to our web site ([www.eizoglobal.com](http://www.eizoglobal.com)).

### Attention

- For installation, follow the User's Manual of the arm or stand.
- When using another manufacturer's arm or stand, be sure to check the following points with the manufacturer and select an arm or stand conforming to the VESA standard. For installation, use the screws that secure the stand on the main unit.
  - Intervals for screws holes on the mount: 100 mm x 100 mm
  - Thickness of the plate: 2.6 mm
  - Maximum permissible weight: strong enough to support the total weight of the monitor (without stand) and attachments such as cables.
- Use the arm or stand within the following range (of tilt angle).
  - 45° Up, 45° Down
- Connect the cables after attaching the arm or stand.
- The monitor, arm and stand are weighty. Dropping the product may result in injury or product damage.
- Regularly check the tightness of the screws. If the screws are loose, the monitor may come off, which may result in injury or equipment damage.



## ● Installation

**1. To avoid damaging the LCD panel, spread out a soft cloth on a stable surface and place the LCD panel facing down on the cloth.**

**2. Remove the stand.**

Prepare a screwdriver separately. Use the screwdriver to remove four screws that secure the stand on the main unit.

**3. Attach the monitor to the arm (or stand).**

Use the screws that you have removed in the step 2.

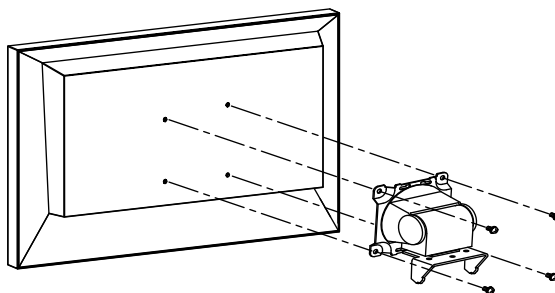

## Connecting HDMI Devices

Connecting a monitor that supports HDMI to this product allows you to output (duplicate or extend) video images as a sub monitor.

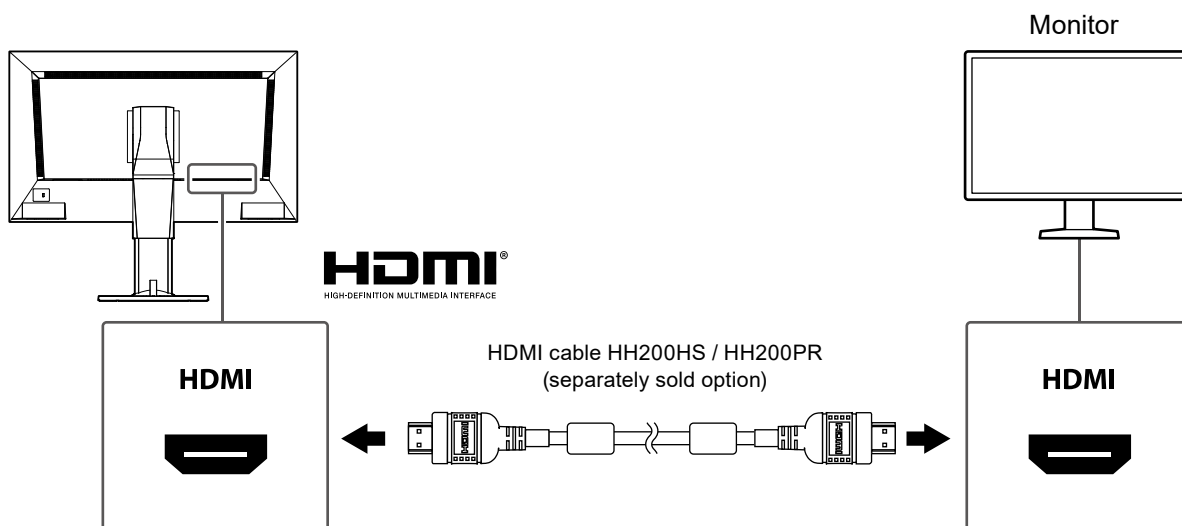

# Specifications

LCD panel	Type	VA		
	Backlight	LED		
	Size	69 cm (27.0 inch) (Diagonal Viewable Size: 68.6 cm)		
	Resolution	1920 dots × 1080 lines		
	Viewable image size (W x H)	597.6 mm × 336.15 mm		
	Pixel pitch	0.311 mm		
	Display colors	8 bit color	16.77 million	
	Viewing angles (H / V, typical)	89° / 89°		
	Contrast ratio (typical)	3000 : 1		
	Response time (typical)	Black to White: 7 ms White to Black: 5 ms		
LAN	Standard	IEEE802.3ab (1000 BASE-T), IEEE802.3u (100 BASE-TX)		
	Communication Speed	1000 Mbps, 100 Mbps		
Video Signals (Network)	Terminal	RJ-45		
	Video compression format	H.264 / H.265, MJPEG		
	Maximum resolution	H.264 / H.265	3840 × 2160* <sup>1</sup>	
		MJPEG	640 × 480	
	Maximum frame rate	60 fps* <sup>2</sup>		
	Maximum bit rate	8192 kbps		
Number of displayed network cameras	Max. 32 units			
Video signals (HDMI)	Output terminal	HDMI		
	Color bit depth	8 bit		
	Dot clock	Max. 148.5 MHz		
	Digital scan frequency (H / V)	28.125 kHz to 67.5 kHz / 25 Hz to 60 Hz		
	Color format	RGB		
USB	Port	Downstream port x 2		
	Standard	Compliant with USB Specification Revision 2.0		
	Communication speed	480 Mbps (high speed), 12 Mbps (full speed), 1.5 Mbps (low speed)		
	Power supply	Max. 500 mA / 1 port		
Power supply	Power supply input	100 to 240 V, 50/60 Hz, 0.60 A to 0.30 A		
	Maximum power consumption	59 W or less		
	Maximum power consumption in standby mode	16 W or less		
Physical specifications	Outside dimensions	640 mm × 404.5 to 554.5 mm × 245 mm (W × H × D) (tilt angle: 0°)		
	Outside dimensions (monitor)	640 mm × 379 mm × 65 mm (W × H × D)		
	Net weight	Approx. 9.9 kg or less		
	Weight (monitor)	Approx. 7.1 kg or less		
	Tilt	35° Up, -5° Down		
Operating environmental specifications	Temperature	0 °C to 40 °C		
	Humidity	20 % to 80 % R.H. (no condensation)		
	Air pressure	540 hPa to 1060 hPa		
Transportation / storage environmental specifications	Temperature	-20 °C to 60 °C		
	Humidity	10 % to 90 % R.H. (no condensation)		
	Air pressure	200 hPa to 1060 hPa		

- \*1 Images are not displayed when the maximum resolution is exceeded. Reduce the resolution and the bit rate for the network camera.
- \*2 The maximum frame rate differs depending on the resolution. (Refer to “Display capability” (page 27) )

## Display capability

Display capability of this product is as follows:

### H.264 / H.265 (when “Bit rate” is set to “4096 kbps”)

At 1-screen display	3840 × 2160 / 30 fps, 1920 × 1080 / 60 fps, 1280 × 720 / 60 fps
At 4-screen display	3840 × 2160 / 20 fps, 1920 × 1080 / 60 fps, 1280 × 720 / 60 fps
At 9-screen display	1920 × 1080 / 30 fps, 1280 × 720 / 50 fps, 640 × 480 / 60 fps
At 12-screen display	1920 × 1080 / 20 fps, 1280 × 720 / 40 fps, 640 × 480 / 60 fps
At 16-screen display	1920 × 1080 / 20 fps, 1280 × 720 / 30 fps, 640 × 480 / 50 fps
At 32-screen display	1280 × 720 / 15 fps, 640 × 480 / 30 fps

### MJPEG

640 × 480 / 30 fps

#### Attention

- The values above are provided for reference purposes. Images are not displayed properly when display capability is exceeded because of network camera settings, network installation environment or other reasons. When images are not displayed properly, reduce the network camera resolution and bit rate. Set the network cameras according to the User's Manual of the camera used.

## Outline Dimensions

Unit: mm

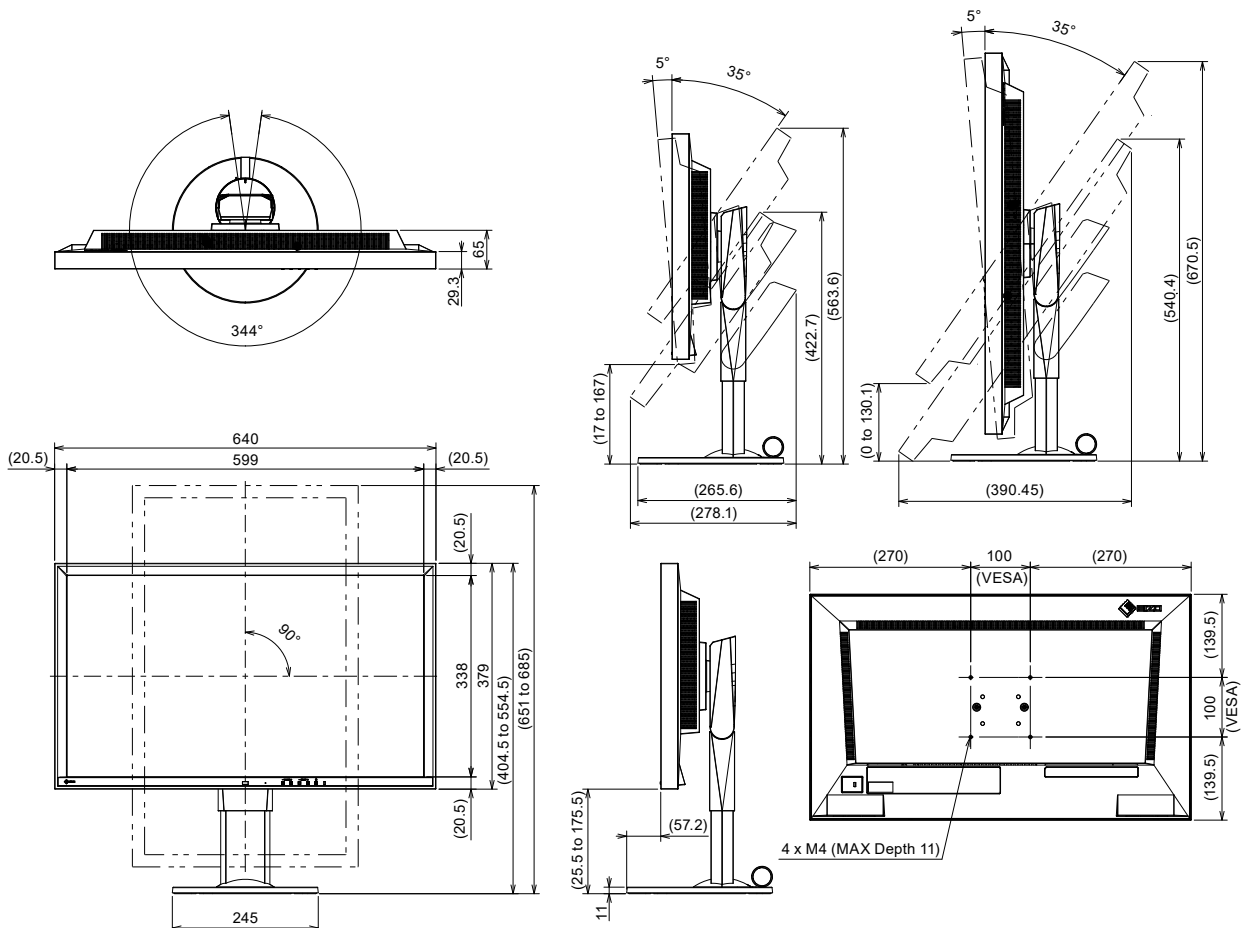

# Troubleshooting

## The screen is not displayed

Problem	Possible cause and remedy
<b>1. The screen is not displayed</b> <ul style="list-style-type: none"><li>• Power indicator is not turned on</li></ul>	<ul style="list-style-type: none"><li>• Is the main power turned on?</li><li>• Is the power correctly connected? Connect the power cord.</li></ul>
<ul style="list-style-type: none"><li>• Power indicator is on: red</li></ul>	<ul style="list-style-type: none"><li>• Press  on the front of the product.</li></ul>

# Imaging Problems

Problem	Possible cause and remedy
<p>1. The display images are not smooth / camera images are not displayed (when camera images are being displayed)</p>	<ul style="list-style-type: none"> <li>• Reduce the resolution and/or bit rate set for the network camera. (For details, refer to the "Installation Manual".)</li> <li>• Check whether the used hubs and network cables are appropriate for handling the amount of information transmitted.</li> <li>• Move to the setting screen and return to the live image screen.</li> </ul>
<p>2. The camera images are not displayed properly on the live image screen about 30 seconds after turning the power off by pushing  on the main unit of the product.</p>	<ul style="list-style-type: none"> <li>• If the main power supply is turned on right after it is turned off, images may not be displayed properly for the first several minutes. After several minutes, the screen returns to a normal display.</li> </ul>
<p>3. The time of the network camera and the time of the system do not match (when a camera images are being displayed)</p>	<ul style="list-style-type: none"> <li>• On the setting screen, adjust the time of the network camera to match the time of this product. (For details, refer to the "Installation Manual".)</li> </ul>
<p>4. An error message "E**-**" is displayed in the camera image display area</p>	<ul style="list-style-type: none"> <li>• When Communication failed ("E01-**") <ul style="list-style-type: none"> <li>- A number of devices exceeding the allowable number of devices for simultaneous connection may be connected to the network camera.</li> <li>Disconnect other network devices accessing the camera or reduce the resolution of the camera. (For details, refer to the "Installation Manual".)</li> </ul> </li> <li>• When Communication failed ("E02-**") <ul style="list-style-type: none"> <li>- Check whether a network cable is connected properly.</li> <li>- Check whether the network camera is turned on.</li> <li>- Check whether the username and password for the camera are set correctly in the system.</li> <li>- Isn't there an IP address conflict among the monitor and network cameras?</li> <li>- If "Certificate Validation" is enabled, is the certificate expiration date correct? (For details, refer to the "Installation Manual".)</li> </ul> </li> <li>• When Communication failed ("E03-**") <ul style="list-style-type: none"> <li>- Network bandwidth may be overwhelmed or the display capability of this product may have been exceeded.</li> <li>Reduce the resolution and/or bit rate set for the network camera. (For details, refer to the "Installation Manual".)</li> </ul> </li> <li>• When in Incompatible resolution ("E04-**") <ul style="list-style-type: none"> <li>- A resolution which is incompatible with this product may be set.</li> <li>Try changing the resolution of the network camera.</li> </ul> </li> <li>• When Compression format is mismatched ("E05-**") <ul style="list-style-type: none"> <li>- The streaming format from the network camera may be different from that of this product.</li> <li>Check the settings of the camera and this product and then restart this product.</li> </ul> </li> <li>• When Unapproved parameters ("E06-**") <ul style="list-style-type: none"> <li>- The Multicast setting value may not be set correctly. Check the settings of the camera.</li> </ul> </li> <li>• If it is a network connection error (E07-**): <ul style="list-style-type: none"> <li>- This product may not be connected to the network, possibly LAN cable is not connected. Check the network connection.</li> </ul> </li> </ul>

# Setting Problems

Problem	Possible cause and remedy
1. Cannot log in	<ul style="list-style-type: none"> <li>• Enter the user name and password again.</li> <li>• Reset the account information using the Reset button and log in as the default setting account. (For details, refer to “Controls and Functions” (page 10))</li> </ul>
2. Only one camera is recognized when using a video encoder that supports multiple channels	<ul style="list-style-type: none"> <li>• Manually register the number of channels that will be used. (For details, refer to the “Installation Manual”.)</li> </ul>
3. A communication error message is displayed when “Apply” is selected for network camera manual registration	<ul style="list-style-type: none"> <li>• There may be a problem with network camera communication.</li> <li>• Check the network connection status and camera registration details.</li> </ul>
4. Cannot register a new user	<ul style="list-style-type: none"> <li>• Duplicate user names cannot be registered.</li> <li>• Only up to 10 users can be registered. Check whether 10 users have already been registered. (For details, refer to the “Installation Manual”.)</li> <li>• Check that you have entered correct user name and password for the security camera.</li> </ul>
5. Cannot delete a user	<ul style="list-style-type: none"> <li>• If only one user is registered as the "ADMIN" user level, it cannot be deleted. At least one user is required as the "ADMIN" user. Check the registered user information. (For details, refer to the “Installation Manual”.)</li> </ul>
6. Cannot communicate with the camera	<ul style="list-style-type: none"> <li>• Check the settings of the network camera and the system. For details, contact the system administrator.</li> </ul>
7. The set date and time are not displayed correctly	<ul style="list-style-type: none"> <li>• If the system is not connected to the power supply for one week or longer, the date and time will not be displayed correctly. In such a case, set the date and time again. (For details, refer to the “Installation Manual”.)</li> </ul>
8. Web browser screen cannot be displayed	<ul style="list-style-type: none"> <li>• Check if there is no conflict of IP addresses for devices on the same network. Connecting multiple units of this product to the same network without changing their default values will result in an IP address conflict. For information on network settings, refer to “Performing Network Settings” (page 18).</li> </ul>

## Other Problems

Problem	Possible cause and remedy
1. The mouse / keyboard does not work	<ul style="list-style-type: none"> <li>• Check whether the USB cable is connected properly.</li> <li>• Pull out the USB cable and connect it again.</li> <li>• Isn't the USB lock function enabled? (For details, refer to the "Installation Manual".)</li> </ul>
2. The mouse / keyboard responses lag	<ul style="list-style-type: none"> <li>• Reduce the resolution and/or bit rate set for the network camera (for details, refer to your User's Manual of the network camera or "Installation Manual" of this product).</li> </ul>
3. The network camera display position cannot be changed	<ul style="list-style-type: none"> <li>• The user level authorized to operate the camera is "CAMERA CONTROL" or "ADMIN". (For details, refer to the "Installation Manual".)</li> <li>• Display position of the network camera cannot be changed during sequential display. (For details, refer to the "Installation Manual".)</li> </ul>
4. Restarts all of a sudden	<ul style="list-style-type: none"> <li>• When the temperature inside the product rises high, this product may restart repeatedly. Check the temperature around this product. The internal temperature may rise high when the product is used in a narrow or poorly ventilated place or when the product is used with an object placed on top of it.</li> </ul>
5. Cannot change brightness	<ul style="list-style-type: none"> <li>• Press and hold BRIGHT- or BRIGHT+.</li> </ul>
6. VOLUME or MUTE button does not respond.	<ul style="list-style-type: none"> <li>• These buttons cannot be used at the moment. They will be supported by a future update of the software.</li> </ul>

# Appendix

## License

---

This product includes open source software.

If the open source software contains a product for which usage is granted under a GPL (GNU GENERAL PUBLIC LICENSE) license, EIZO Corporation will, in line with the GPL usage license conditions, provide the source code for corresponding GPL software via a medium, such as CD-ROM, at a cost to individuals and organizations who make contact via the following contact information for a minimum period of three years after purchase of the product.

We will also provide the source code for corresponding LGPL (GNU LESSER GENERAL PUBLIC LICENSE) software of products that include LGPL software licensed under the LGPL in the same manner as stated above.

### **Contact information**

[www.eizoglobal.com/contact/index.html](http://www.eizoglobal.com/contact/index.html)

\*Contact your local EIZO representative.

Except for open source software licensed under GPL, LPGL or other licenses, any transferring, copying, reverse assembly, reverse compiling or reverse engineering of any software included with this product is strictly prohibited. Further, exporting of any software included with this product in violation of applicable export laws is strictly prohibited.

This product is covered by one or more claims of the patents listed at [patentlist.hevcadvance.com](http://patentlist.hevcadvance.com).



## Warning for Radio interference

For U.S.A., Canada Only

### FCC Supplier's Declaration of Conformity

We, the Responsible Party

EIZO Inc.

5710 Warland Drive, Cypress, CA 90630

Phone: (562) 431-5011

declare that the product

Trade name: EIZO

Model: DuraVision FDF2711W-IP

is in conformity with Part 15 of the FCC Rules. Operation of this product is subject to the following two conditions: (1) this device may not cause harmful interference, and (2) this device must accept any interference received, including interference that may cause undesired operation.

### WARNING!

This equipment has been tested and found to comply with the limits for a Class A digital device, pursuant to Part 15 of the FCC Rules. These limits are designed to provide reasonable protection against harmful interference when the equipment is operated in a commercial environment. This equipment generates, uses, and can radiate radio frequency energy and if not installed and used in accordance with the instruction manual, may cause harmful interference to radio communications. Operation of this equipment in a residential area is likely to cause harmful interference in which case the user will be required to correct the interference at his own expense.

Changes or modifications not expressly approved by the party responsible for compliance could void the user's authority to operate the equipment.

#### Note

Use the attached specified cable below or EIZO signal cable with this monitor so as to keep interference within the limits of a Class A digital device.

- AC Cord
- Shielded Signal Cable (enclosed)

### Canadian Notice

This Class A information technology equipment complies with Canadian ICES-003.

Cet équipement informatique de classe A est conforme à la norme NMB-003 du Canada.

### For Europe, Australia, New Zealand, etc Only

#### Warning

Operation of this equipment in a residential environment could cause radio interference.

#### Warnung

Der Betrieb dieses Geräts in einer Wohnumgebung konnte Funkstörungen verursachen.

#### Avertissement

L'utilisation de cet équipement dans une zone résidentielle pourrait provoquer des interférences radio.

# LIMITED WARRANTY

---

EIZO Corporation (hereinafter referred to as “EIZO”) and distributors authorized by EIZO (hereinafter referred to as the “Distributors”) warrant, subject to and in accordance with the terms of this limited warranty (hereinafter referred to as the “Warranty”), to the original purchaser (hereinafter referred to as the “Original Purchaser”) who purchased the product specified in this document (hereinafter referred to as the “Product”) from EIZO or Distributors, that EIZO and Distributors shall, at their sole discretion, either repair or replace the Product at no charge if the Original Purchaser becomes aware within the Warranty Period (defined below) that the Product malfunctions or is damaged in the course of normal use of the Product in accordance with the description in the instruction manual of the Product (hereinafter referred to as the “User’s Manual”).

The period of this Warranty is two (2) years from the date of purchase of the Product (hereinafter referred to as the “Warranty Period”). EIZO and Distributors shall bear no liability or obligation with regard to the Product in relation to the Original Purchaser or any third parties other than as provided under this Warranty.

EIZO and Distributors will cease to hold or store any parts (excluding design parts) of the Product upon expiration of seven (7) years after the production of the Product is discontinued. In repairing the monitor, EIZO and Distributors will use renewal parts which comply with our QC standards. If the unit cannot be repaired due to its condition or the stockout of a relevant part, EIZO and Distributors may offer the replacement by a product with equivalent performance instead of repairing it.

The Warranty is valid only in the countries or territories where the Distributors are located. The Warranty does not restrict any legal rights of the Original Purchaser.

Notwithstanding any other provision of this Warranty, EIZO and Distributors shall have no obligation under this Warranty whatsoever in any of the cases as set forth below:

- (a) Any defect of the Product caused by freight damage, modification, alteration, abuse, misuse, accident, incorrect installation, disaster, adherent dust, faulty maintenance and/or improper repair by third party other than EIZO and Distributors;
- (b) Any incompatibility of the Product due to possible technical innovations and/or regulations;
- (c) Any deterioration of the sensor, including measurement value of the sensor;
- (d) Any defect of the Product caused by external equipments;
- (e) Any defect of the Product caused by the use under environmental conditions other than EIZO and Distributors’ estimation;
- (f) Any deterioration of the attachments of the Product (e.g. cables, User’s Manual, CD-ROM, etc.);
- (g) Any deterioration of the consumables, and/or accessories of the Product (e.g. batteries, remote controller, touch pen, etc.);
- (h) Any deformation, discoloration, and/or warp of the exterior of the Product including that of the surface of the LCD panel;
- (i) Any defect of the Product caused by placement in a location where it may be affected by strong vibration or shocks;
- (j) Any defect of the Product caused by liquid leaking from battery;
- (k) Any deterioration of display performance caused by the deterioration of expendable parts such as the LCD panel and/or backlight, etc. (e.g. changes in brightness, changes in brightness uniformity, changes in color, changes in color uniformity, defects in pixels including burnt pixels, etc.);
- (l) Any deterioration or malfunction of the cooling fan caused by adherent dust.

To obtain service under the Warranty, the Original Purchaser must deliver the Product, freight prepaid, in its original package or other adequate package affording an equal degree of protection, assuming the risk of damage and/or loss in transit, to the local Distributor. The Original Purchaser must present proof of purchase of the Product and the date of such purchase when requesting services under the Warranty.

The Warranty Period for any replaced and/or repaired product under this Warranty shall expire at the end of the original Warranty Period.

EIZO OR DISTRIBUTORS ARE NOT RESPONSIBLE FOR ANY DAMAGE TO, OR LOSS OF, DATA OR OTHER INFORMATION STORED IN ANY MEDIA OR ANY PART OF ANY PRODUCT RETURNED TO EIZO OR DISTRIBUTORS FOR REPAIR.

EIZO AND DISTRIBUTORS MAKE NO FURTHER WARRANTIES, EXPRESSED OR IMPLIED, WITH RESPECT TO THE PRODUCT AND ITS QUALITY, PERFORMANCE, MERCHANTABILITY OR FITNESS FOR ANY PARTICULAR USE. IN NO EVENT SHALL EIZO OR DISTRIBUTORS BE LIABLE FOR ANY INCIDENTAL, INDIRECT, SPECIAL, CONSEQUENTIAL OR OTHER DAMAGE WHATSOEVER (INCLUDING, WITHOUT LIMITATION, DAMAGES FOR LOSS OF PROFIT, BUSINESS INTERRUPTION, LOSS OF BUSINESS INFORMATION, OR ANY OTHER PECUNIARY LOSS) ARISING OUT OF THE USE OR INABILITY TO USE THE PRODUCT OR IN ANY CONNECTION WITH THE PRODUCT, WHETHER BASED ON CONTRACT, TORT, NEGLIGENCE, STRICT LIABILITY OR OTHERWISE, EVEN IF EIZO OR DISTRIBUTORS HAVE BEEN ADVISED OF THE POSSIBILITY OF SUCH DAMAGES. THIS EXCLUSION ALSO INCLUDES ANY LIABILITY WHICH MAY ARISE OUT OF THIRD PARTY CLAIMS AGAINST THE ORIGINAL PURCHASER. THE ESSENCE OF THIS PROVISION IS TO LIMIT THE POTENTIAL LIABILITY OF EIZO AND DISTRIBUTORS ARISING OUT OF THIS LIMITED WARRANTY AND/OR SALES.

# Recycling Information/Informationen zum Thema Recycling/ Informations sur le recyclage/Сведения по утилизации

English

Deutsch

Français

Русский

## Recycling Information

This product, when disposed of, is supposed to be collected and recycled according to your country's legislation to reduce environmental burden. When you dispose of this product, please contact a distributor or an affiliate in your country.

The contact addressees are listed on the EIZO website below.

[www.eizoglobal.com](http://www.eizoglobal.com)

For recycling information for customers in Switzerland, please refer to the following website.

[www.swico.ch](http://www.swico.ch)

## Informationen zum Thema Recycling

Dieses Produkt muss gemäß den Vorschriften Ihres Landes zur Entlastung der Umwelt recyclet werden. Wenden Sie sich bei der Entsorgung dieses Produkts an einen Verteiler oder eine Tochtergesellschaft in Ihrem Land.

Die Adressen zur Kontaktaufnahme sind auf der unten angegebenen Website von EIZO aufgeführt.

[www.eizoglobal.com](http://www.eizoglobal.com)

Kunden in der Schweiz entnehmen Informationen zum Recycling der folgenden Website:

[www.swico.ch](http://www.swico.ch)

## Informations sur le recyclage

Ce produit doit être jeté aux points de collecte prévus à cet effet et recyclé conformément à la législation de votre pays, afin de réduire l'impact sur l'environnement. Lorsque vous jetez ce produit, veuillez contacter un distributeur ou une société affiliée de votre pays.

Les adresses des distributeurs sont répertoriées sur le site Web EIZO ci-dessous.

[www.eizoglobal.com](http://www.eizoglobal.com)

Pour les clients en Suisse, veuillez consulter le site Web suivant afin d'obtenir des informations sur le recyclage.

[www.swico.ch](http://www.swico.ch)

## Información sobre reciclaje

Este producto debe desecharse y reciclarse según la legislación del país para reducir el impacto medioambiental.

Cuando desee deshacerse de este producto, póngase en contacto con un distribuidor o una filial de su país.

Encontrará las direcciones de contacto en el sitio web de EIZO que se indica a continuación.

[www.eizoglobal.com](http://www.eizoglobal.com)

## Informazioni sul riciclaggio

Per lo smaltimento e il riciclaggio del presente prodotto, attenersi alle normative vigenti nel proprio paese per ridurre l'impatto ambientale.

Per lo smaltimento, rivolgersi ad un distributore o un affiliato presenti nel proprio paese.

Gli indirizzi sono elencati nel sito Web EIZO riportato di seguito.

[www.eizoglobal.com](http://www.eizoglobal.com)

Per informazioni sul riciclaggio per i clienti in Svizzera, consultare il sito Web riportato di seguito.

[www.swico.ch](http://www.swico.ch)

## Återvinningsinformation

När denna produkt kasseras ska den hanteras och återvinnas enligt landets föreskrifter för att reducera miljöpåverkan.

När du kasserar produkten ska du kontakta en distributör eller representant i ditt land.

Kontaktadresserna listas på EIZO-webbplatsen nedan.

[www.eizoglobal.com](http://www.eizoglobal.com)

## Πληροφορίες ανακύκλωσης

Το προϊόν αυτό, όταν απορρίπτεται, πρέπει να συλλέγεται και να ανακυκλώνεται σύμφωνα με τη νομοθεσία της χώρας σας έτσι ώστε να μην επιβαρύνει το περιβάλλον. Για να απορρίψετε το προϊόν, επικοινωνήστε με έναν αντιπρόσωπο ή μια θυγατρική εταιρεία στη χώρα σας.

Οι διευθύνσεις επικοινωνίας αναγράφονται στην τοποθεσία web της EIZO παρακάτω.

[www.eizoglobal.com](http://www.eizoglobal.com)

## Сведения по утилизации

По истечении срока службы данного продукта его следует принести на сборный пункт и утилизировать в соответствии с действующими предписаниями в вашей стране, чтобы уменьшить вредное воздействие на окружающую среду. Прежде чем выбросить данный продукт, обратитесь к дистрибьютору или в местное представительство компании в вашей стране.

Контактные адреса можно найти на веб-узле EIZO.

[www.eizoglobal.com](http://www.eizoglobal.com)

## Informatie over recycling

Wanneer u dit product wilt weggoien, moet het uit milieu-overwegingen worden verzameld en gerecycled volgens de betreffende wetgeving van uw land. Wanneer u dit product wilt weggoien, moet u contact opnemen met een distributeur of een partner in uw land.

De contactadressen worden vermeld op de volgende EIZO-website.

[www.eizoglobal.com](http://www.eizoglobal.com)

## Informação sobre reciclagem

Este produto, quando o deitar fora, deve ser recolhido e reciclado de acordo com a legislação do seu país para reduzir a poluição. Quando deitar fora este produto, contacte um distribuidor ou uma filial no seu país.

Os endereços de contacto estão listados no website do EIZO, abaixo.

[www.eizoglobal.com](http://www.eizoglobal.com)

## Oplysninger om genbrug

Dette produkt forventes ved bortskaffelse at blive indsamlet og genbrugt i overensstemmelse med lovgivningen i dit land for at reducere belastningen af miljøet. Når du bortskaffer denne produkt, skal du kontakte en distributør eller et tilknyttet selskab i dit land.

Adresserne på kontaktpersonerne er angivet på EIZO's websted nedenfor.

[www.eizoglobal.com](http://www.eizoglobal.com)

## Kierrätystä koskevia tietoja

Tuote tulee hävittää kierrättämällä maan lainsäädännön mukaisesti ympäristön kuormittumisen vähentämiseksi. Kun hävität tuotteen, ota yhteyttä jälleenmyyjään tai tytäryhtiöön maassasi.

Yhteystiedot löytyvät EIZOn Internet-sivustolta.

[www.eizoglobal.com](http://www.eizoglobal.com)

## Wykorzystanie surowców wtórnych

Ten produkt po zużyciu powinien być zbierany i przetwarzany zgodnie z krajowymi przepisami dotyczącymi ochrony środowiska. Wyrzucając ten produkt, należy skontaktować się z lokalnym dystrybutorem lub partnerem. Adresy kontaktowe można znaleźć we wskazanej poniżej witrynie internetowej firmy EIZO.

[www.eizoglobal.com](http://www.eizoglobal.com)

## Informace o recyklaci

Při likvidaci produktu musí být produkt vyzvednut a recyklován podle zákonů příslušné země, aby nedocházelo k zatěžování životního prostředí. Zbavujete-li se produktu, kontaktujte distributora nebo pobočku ve své zemi. Kontaktní adresy jsou uvedeny na následující webové stránce společnosti EIZO.

[www.eizoglobal.com](http://www.eizoglobal.com)

## Ringlussevõtu alane teave

Keskkonnakoormuse vähendamiseks tuleks kasutatud tooted kokku koguda ja võtta ringlusse vastavalt teie riigi seadustele. Kui kõrvaldate käesoleva toote, võtke palun ühendust turustaja või filiaaliga oma riigis.

Kontaktisikud on toodud EIZO veebilehel järgmisel aadressil:

[www.eizoglobal.com](http://www.eizoglobal.com)

## Újrahasznosítási információ

Jelen terméket, amikor eldobjuk, az illető ország törvényei alapján kell összegyűjteni és újrahasznosítani, hogy csökkentjük a környezet terhelését. Amikor ezt a terméket eldobja, kérjük lépjen kapcsolatba egy országon belüli forgalmazóval vagy társvállalkozással.

A kapcsolat címei az EIZO alábbi weboldalán található felsorolva:

[www.eizoglobal.com](http://www.eizoglobal.com)

## Podatki o recikliranju

Ob koncu uporabe odslužen izdelek izročite na zbirno mesto za recikliranje v skladu z okoljevarstveno zakonodajo vaše države. Prosimo, da se pri odstranjevanju izdelka obrnete na lokalnega distributerja ali podružnico.

Kontaktni naslovi so objavljeni na spodaj navedenih spletnih straneh EIZO:

[www.eizoglobal.com](http://www.eizoglobal.com)

## Informácie o recyklácii

Pri likvidácii musí byť tento výrobok recyklovaný v súlade s legislatívou vašej krajiny, aby sa znížilo zaťaženie životného prostredia. Keď sa chcete zbaviť tohto výrobku, kontaktujte prosím distribútora alebo pobočku vo vašej krajine.

Zoznam kontaktných adries je uvedený na nasledovnej webovej stránke firmy EIZO:

[www.eizoglobal.com](http://www.eizoglobal.com)

## Pārstrādes informācija

Utilizējot šo produktu, tā savākšana un pārstrāde veicama atbilstoši jūsu valsts likumdošanas prasībām attiecībā uz slodzes uz vidi samazināšanu. Lai veiktu šī produkta utilizāciju, sazinieties ar izplatītāju vai pārstāvniecību jūsu valstī. Kontaktadresses ir norādītas zemāk minētajā EIZO tīmekļa vietnē.

[www.eizoglobal.com](http://www.eizoglobal.com)

## Informacija apie gražinamąjį perdirbimą

Šalinant (išmetant) šiuos gaminius juos reikia surinkti ir perdirbti gražinamuoju būdu pagal jūsų šalies teisės aktus, siekiant sumažinti aplinkos teršimą. Kai reikia išmesti šį gaminį, kreipkitės į jūsų šalyje veikiančią gaminių pardavimo atstovybę arba jos filialą.

Kontaktiniai adresatai nurodyti EIZO interneto svetainėje.

[www.eizoglobal.com](http://www.eizoglobal.com)

## Информация относительно рециклиране

При изхвърлянето на този продукт се предлага събирането и рециклирането му съобразно законите на вашата страна за да се намали замърсяването на околната среда. Когато искате да се освободите от този продукт, моля свържете се с търговския му представител или със съответните органи отговарящи за това във вашата страна.

Данните за връзка с нас са описани на следния Интернет сайт на EIZO:

[www.eizoglobal.com](http://www.eizoglobal.com)

## Informație referitoare la reciclare

Acest produs, când debarasat, trebuie colectat și reciclat conform legislației țării respective ca să reducem sarcina mediului. Când se debarasează de acest produs, vă rugăm să contactați un distribuitor sau un afiliat al țării respective.

Adresele de contact le găsiți pe pagina de web al EIZO:

[www.eizoglobal.com](http://www.eizoglobal.com)

## معلومات عن اعادة التدوير

عند التخلص من هذا المنتج، من الضروري تجميعه واعادة تدويره وفقاً للقوانين المتبعة في بلدك لتقليل العبء المسلط على البيئة. عندما تتخلص من هذا المنتج، يرجى الاتصال بموزع أو طرف منتسب إليه في بلدك. عناوين الاتصال مدرجة في موقع ايزو EIZO ادناه على شبكة الانترنت.

[www.eizoglobal.com](http://www.eizoglobal.com)

### Gerü Dönüşüm Bilgisi

Bu ürünün, atılacağı zaman, ülkenizin çevre kirliliğinin azaltılması konusundaki mevzuatına göre toplanması ve yeniden değerlendirilmesi gerekmektedir. Ürünü atacağınız zaman lütfen ülkenizdeki bir distribütör veya ilgili kuruluşla temasa geçiniz.

İrtibat adresleri aşağıdaki EIZO web sitesinde verilmiştir.

[www.eizoglobal.com](http://www.eizoglobal.com)



## **EIZO Corporation**

153 Shimokashiwano, Hakusan, Ishikawa 924-8566 Japan

## **EIZO Europe GmbH**



Helmut-Grashoff-Strasse 18, 41179 Mönchengladbach, Germany

## **艺卓显像技术(苏州)有限公司**

中国苏州市苏州工业园区展业路 8 号中新科技工业坊 5B

[www.eizoglobal.com](http://www.eizoglobal.com)

Copyright © 2019 EIZO Corporation. All rights reserved.

00N0N180A1   
SUM-FDF2711W-IP-4 

1st Edition-December, 2019 Printed in Japan.