

Dimensions

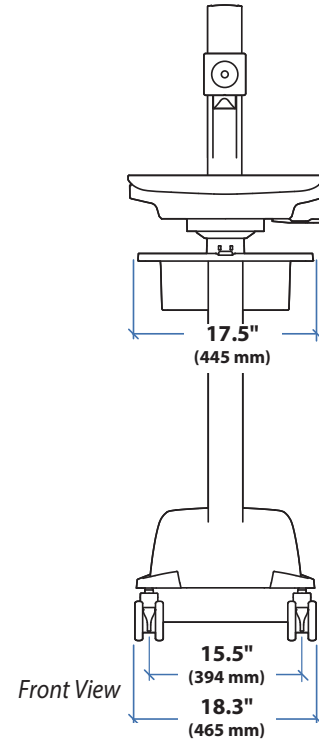

CPU Compartment

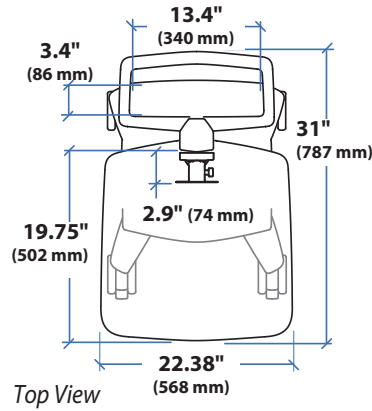
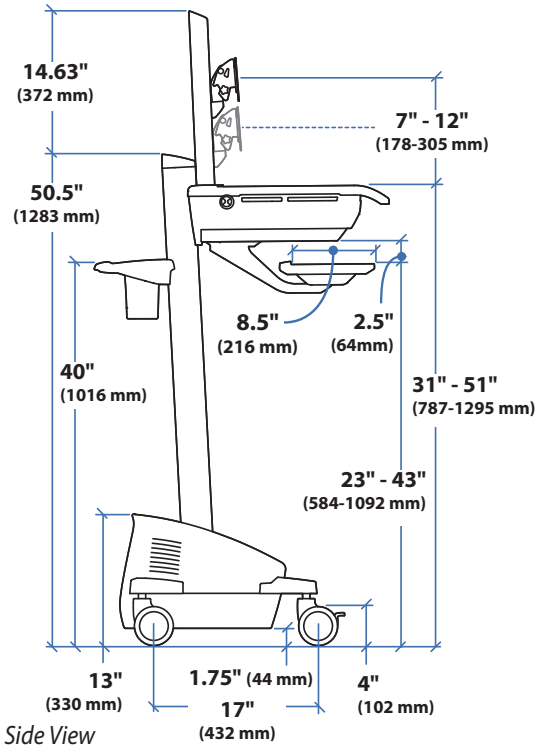
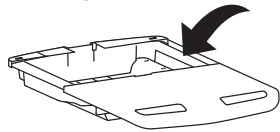

When figuring dimensions, include mounted accessories, protruding cables and port replicators or docking stations.

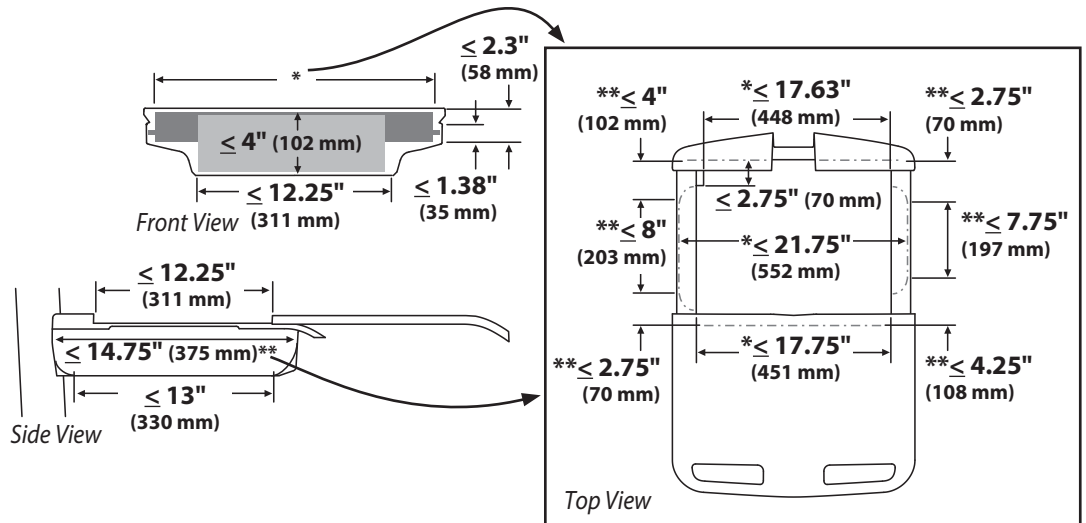

Weight Capacity

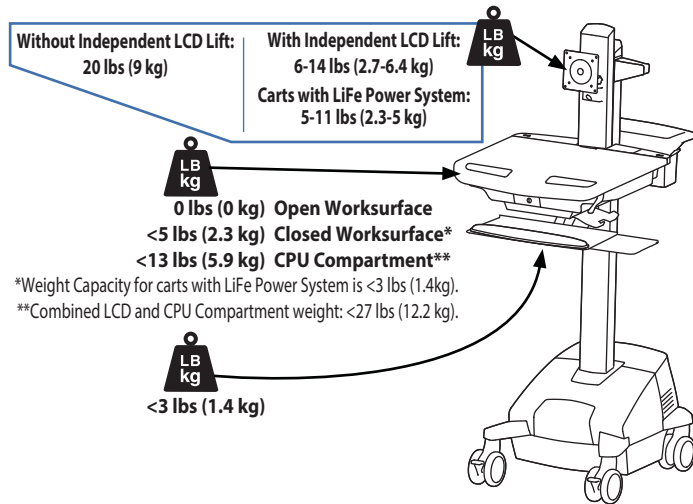

Range of Motion

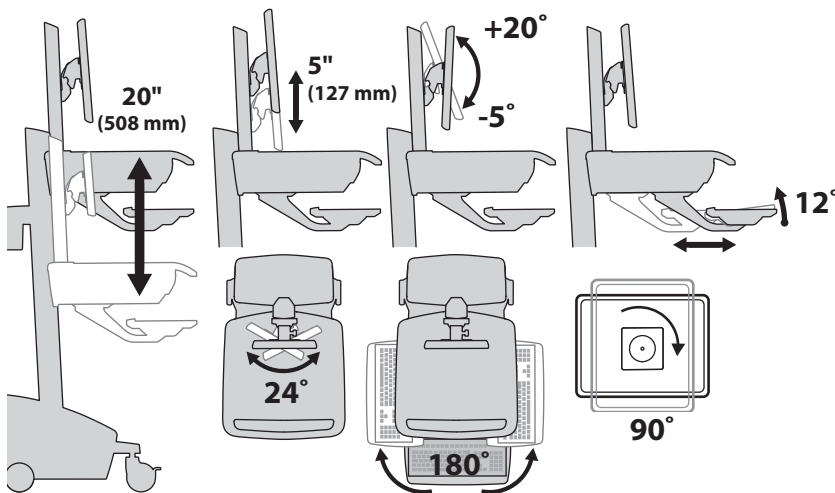

© 2014 Ergotron, Inc. rev. 03/28/2022 DIM-SV42Pivot Content is subject to change without notification

Americas Sales and Corporate Headquarter

St. Paul, MN USA
 (800) 888-8458
 +1-651-681-7600
 www.ergotron.com
 insidesales@ergotron.com

EMEA Sales

Amersfoort, The Netherlands
 +31 33 45 45 600
 www.ergotron.com
 info.eu@ergotron.com

APAC Sales

Sydney, Australia
 www.ergotron.com
 apacustomerservice@ergotron.com

Worldwide OEM Sales

www.ergotron.com
 info.oem@ergotron.com