

Lenovo

ThinkVision

T75 Smart Large Format Display

User Guide

Product model: 62F4

Think

Product Number

62F4-KATC-WW

Type/Model

K21750UT0



First Edition (March 2021)

© Copyright Lenovo 2021 All rights reserved.

LENOVO products, data, computer software, and services have been developed exclusively at private expense and are sold to governmental entities as commercial items as defined by 47 C.F.R. 2.101 with limited and restricted rights to use, reproduction and disclosure.

LIMITED AND RESTRICTED RIGHTS NOTICE: IF products, data, computer software, or services are delivered pursuant a General Services Administration "GSA" contract, use, reproduction, or disclosure is subject to restrictions set forth in Contract No. GS-35F-05925.

Catalogue

Chapter 1. Get Started With Your Smart Large Format Display (LFD).....1-1

In The Box.....	1-1
Wall Mounting.....	1-2
Heat Dissipation.....	1-3
Built-in PC Installation.....	1-3
Appearance Is Introduced.....	1-4
The I/O Panel.....	1-5
The Front Button.....	1-7
Features And Specifications.....	1-8
A serial Port Control.....	1-9
The Remote Control.....	1-11

Chapter 2. Explore Your Smart Large Format Display.....2-1

Teams The meeting.....	2-1
Quick Access Controls.....	2-1
The Whiteboard.....	2-2
Notation.....	2-3
All Files.....	2-4
All Application.....	2-5
System Settings.....	2-7
External Signal Source.....	2-10
Built-In Computer.....	2-11
Interest Rates Screen.....	2-12
Lock Screen.....	2-12
Resolution.....	2-13

Chapter 3. Troubleshooting2-1

Appendix A. Important Safety Information.....4-1

Safety Information.....	3-1
Maintenance.....	3-1

Catalogue

Appendix B. Usage Precautions	B-1
Appendix C. Service And Support	C-1
Online Technical Support	C-1
Telephone Technical Support	C-1
Worldwide Telephone List	C-1
Service Information	C-2
Appendix D. Compliance Information	D-1
Recycling Information	D-1
Collecting And Recycling A Disused Lenovo Computer Or Monitor	D-1
Disposing Of Lenovo Computer Components	D-1
Trademarks	D-2

Chapter 1. Get started with your Smart Large Format Display (LFD)

This User Guide contains detailed information about ThinkVision®
TC-CB TC-WW Intelligent Interactive Large screen.

In The Box

The product package should include the following items:

- Smart Large Format Display
- Wall hanger -2 vertical beams
- Wall hanger -1 beam
- Information Flyer
- Power Cord
- HDMI Cable(3m)
- Remote control
- Touch Pen(2)
- AAA Battery(2)
- USB Type B to USB Type A Cable

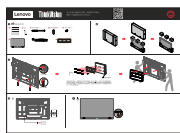
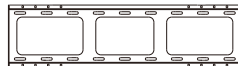
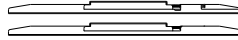
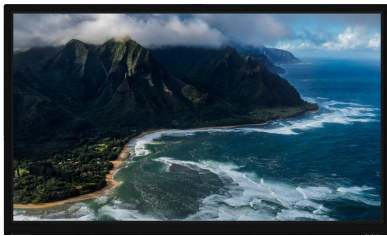

USB A-B



HDMI

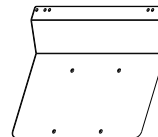
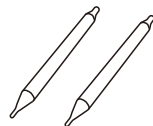

*: Depending on a variety of factors, such as peripheral processing power, file properties, and other factors related to system configuration and operating environment, having different USB connectors on this device can result in different actual transfer rates, often lower than the data transfer rates defined by the respective USB specifications:
-USB 3.2 Gen 1 Used for 5 Gbit/s; USB 3.2 Gen 2 for 10 Gbit/s x USB 3.2 for 2 Gbit/s.

Wall Mounting

1. Installation notes

- When installing wall hanging, at least two or more professionals are required to carry out all the installation work of the machine at the same time. Users should not install themselves without authorization, so as to avoid harm caused by improper operation.
- Please install it in a position designated by professionals so that its strength can support the total weight of the machine and wall hanger for a long time, and take measures to ensure that it has enough strength to withstand external forces. The hanging point should be pressed directly against the wall, do not be installed on the wallpaper board with insufficient strength.
- The machine should be installed on a vertical plane, do not install it on an inclined plane or upward, otherwise, the machine may fall and personal injury may occur.
- In order to prevent accidental damage to the machine and personal accidents, please try to avoid children easily accessible places to install the hanger.
- During installation, please make sure that the screws and fasteners are tightly connected to avoid personal injury caused by falling down of the machine caused by loose screws.
- Installation as shown below, leave ventilation space around the unit:

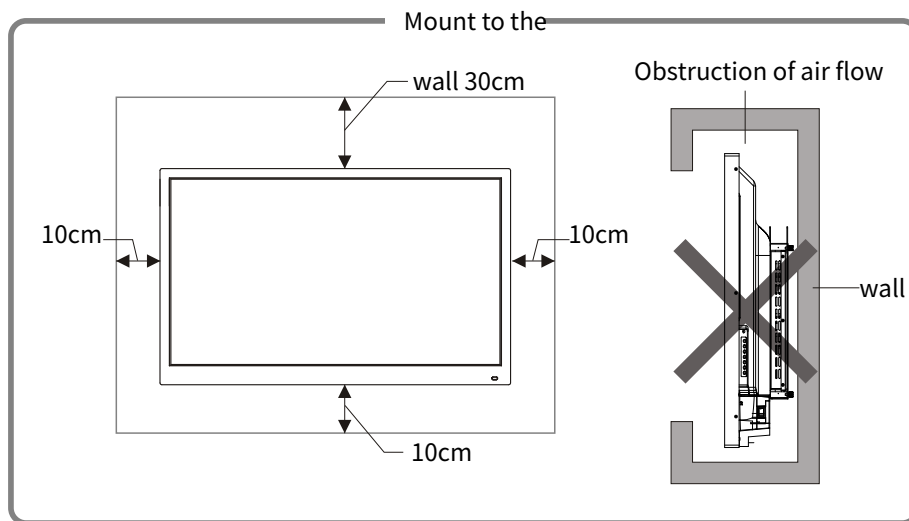

2. For detailed installation steps, see the wall mounting instructions

Heat Dissipation

Distance from mounting surface (mm)			
Left and right side	At the top of the	At the bottom of the	The back of the
100	300	100	100



PAY ATTENTION TO

- In addition to meeting the above requirements, the area of ventilation holes on the bottom, side and top should not be less than 50% of the sealing area to maintain air circulation.
 - When installing the wall mounting, the installation depth of the wall mounting bolts should be greater than 10mm.
-

*Refer to CAS 132-2006 standard.

Built-in PC Installation



WARNING

Do not do the following operations on the built-in computer, otherwise the product may be damaged or unusable!

- Do not plug or unplug the built-in computer when the power is on. Please make sure that the power is disconnected before inserting or unplugging the built-in computer.
 - Do not use the built-in computer without fixing screws or screws missing.
-

This product does not provide built-in computer, if install please follow the following steps:

Step 1: Remove the baffle from the slot of the built-in computer interface card.

INSTRUCTIONS

This step is optional and applies to models with baffles.

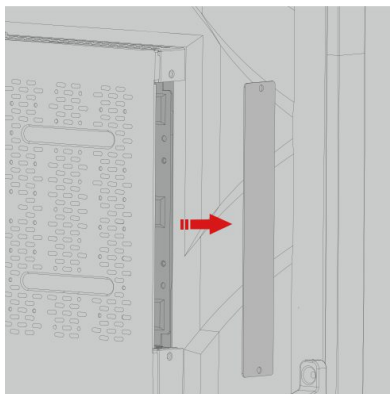

1. Horizontally push the built-in computer into the interface card slot of the built-in computer.

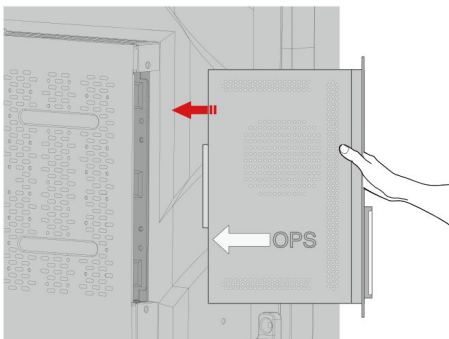

Step 2: Insert the fixing screws through the upper and lower mounting ears and tighten them.

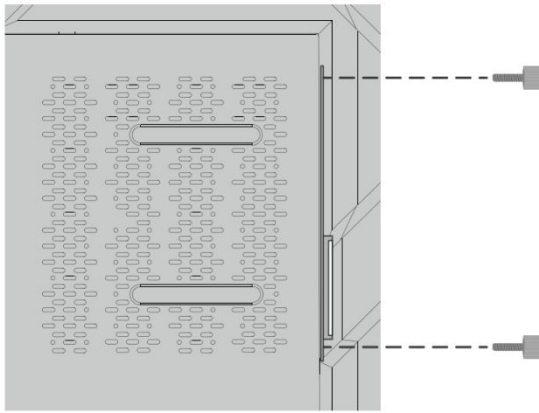

INSTRUCTIONS

- Start the computer and enter the built-in computer signal channel. If the screen is broken, the screen is blinking, or there is no signal, the built-in computer is not installed properly. Please check and reinstall the built-in computer.

Appearance

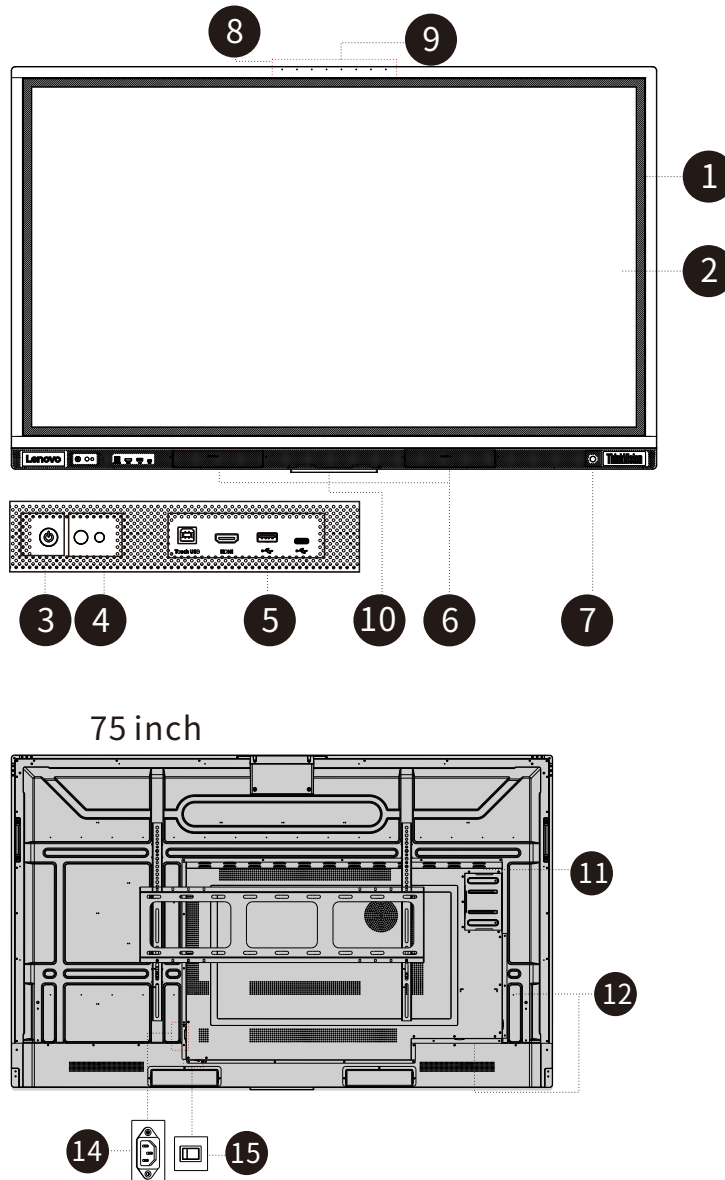

1	Infrared touch screen	8	The microphone
2	Full physical toughened protective glass	9	Usb-a external camera port
3	Power key	10	WIFI module
4	Remote receiving device /light sensing device	11	Built-in computer interface
5	The front interface	12	Rear connection panel
6	The speaker	13	The network interface
7	Infrared body sensor	14	A power outlet
		15	The power switch

The I/O Panel

Front I/O panel

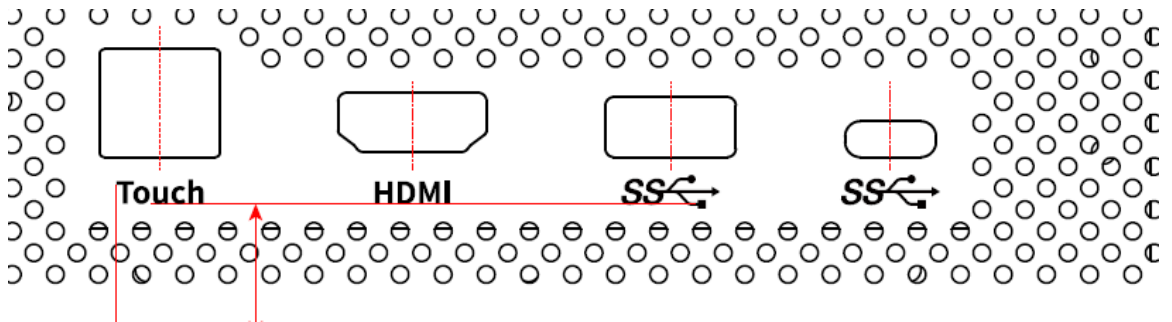

name	
USB	Connect the USB device. Such as mobile hard disk, U disk, USB keyboard and mouse. Support system following, type-c support signal input
Touch USB	Connect to the touch port of the PC.
HDMI IN	Hd signal input port. Combined with "TOUCH USB", the PC can be operated in TOUCH mode.

Rear I/O panel

75 inch

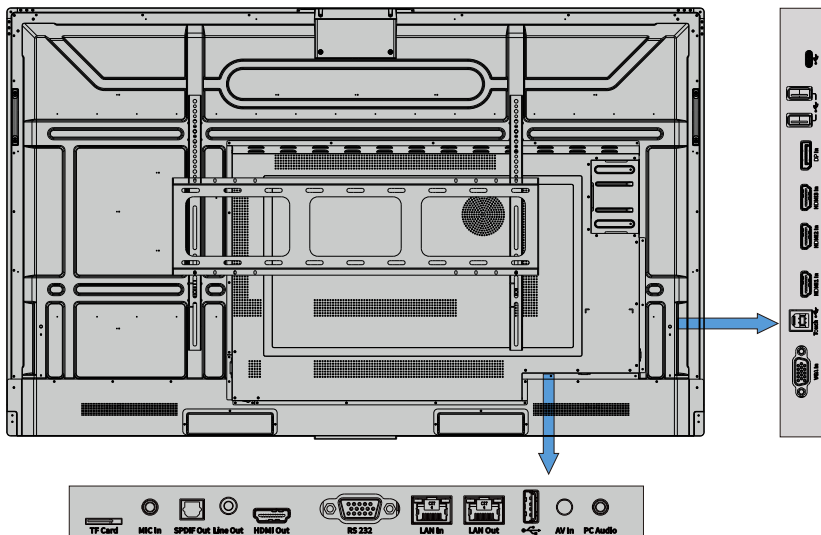

name	Functional description
The microphone	Microphone input port
VGA audio input	Audio input port, used with VGA input.
VGA input	VGA signal input port. Combined with "Touch USB", the PC can be operated in Touch mode.
HDMI 1, 2, 3 inputs	Hd signal input port 1. Combined with "Touch USB", the PC can be operated in Touch mode.
Dp input	DP Digital signal input port. Combined with "Touch USB", the PC can be operated in Touch mode.
USB - 2.0 B touch	Connect to the touch port of the PC.
USB 3.0 android	Local playback, system upgrade.
USB 2.0 android Windows	Connect the USB device. Such as mobile hard disk, U disk, USB keyboard and mouse. Located on the side, support system follow.
RJ45 IN	Network interface, connect to RJ45 terminal, wired network connection.
RJ45 OUT	Network interface, connect RJ45 terminal, wired network output.
RS232	Serial port signal input interface, through the specific serial port control equipment input serial port protocol to achieve the purpose of controlling intelligent large screen.
HDMI OUT	Connect electronic video devices with HDMI input.
Headphone output	Audio output interface, connected to audio input devices, such as headphones, speakers and other devices.
SPDIF	Optical fiber output interface. Connect audio equipment with fiber optic input, such as power amplifier, stereo, speaker box.
Tf card slot port	External expansion storage.
AV IN	Connect to a DVD or set-top box.

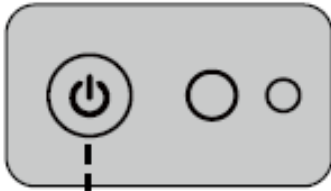

The Front Button





POWER KEY

BOOT

Step 1: After inserting the power cord, turn on the ship AC power switch (at the back of the screen, next to the power socket) to enter the standby state, and the power indicator is red.

Step 2: Press  on the smart screen. Press  on the smart screen to start the smart screen (the indicator is green).

TO TURN IT OFF

Step 1: Press the " " key on the remote control or long press the " " key on the front button to enter the shutdown state, and the indicator light is red.

Step 2: If you want to completely turn off the smart large screen, please turn off the boat switch under the smart large screen (next to the power socket) and pull out the power plug.



PAY ATTENTION TO

- When the intelligent large screen enters the hibernation or shutdown state, the system checks whether the built-in computer is shut down first. If the built-in computer is not shut down, the system shuts down the built-in computer first and then enters the hibernation or shutdown state.
 - The intelligent large screen needs to enter the shutdown state first and then disconnect the power supply, otherwise it may damage the machine; An unexpected power outage may damage the machine. Do not turn the power on/off repeatedly within a short period of time, as this may lead to failure.
-

Features And Specifications

Parameter	75"
Backlight Type	LED
Aspect Ratio	16:9
Viewing Angle	178°
Resolution	3840 × 2160 Pixel
Working Voltage	100 - 240V, 50/60Hz
Stand-by Power Consumption	< 0.5W
Rated Power(No OPS plug in)	≤ 309W
Max Power(OPS operating)	≤ 670W
Rated Current	Max 5.0A
Speaker	15W×2
Cover Glass	Tempered glass
Touch Sensing Technology	Infrared
Touch Points	20 points
Viewable image size	1649.66mm × 927.94mm
The whole machine size	1982.0 x1209.2 x92mm
Packing size	1982.0 x1209.2 x92mm
Storage Temperature/Humidity	-10°C~60°C/10%~80%RH
Operating Temperature/Humidity	0°C~40°C/20%RH~80%RH
Installation Method	Wall hanging or floor stand support
Net Weight	53kg
Gross Weight 86kg	67kg

A Serial Port Control

Rs232 communication cable (please use cross data cable)

PIN	This machine	The computer
1	NC	NC
2	RXD0	TXD0
3	TXD0	RXD0
4	NC	NC
5	GND	GND
6	NC	NC
7	NC	NC
8	NC	NC
9	NC	NC
The shell	GND	GND

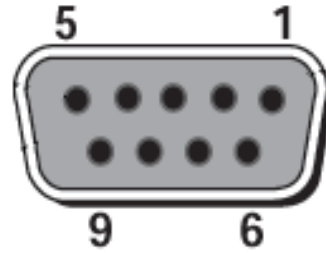

Intelligent large SCREEN RS232 port

Connect the RS-232 interface to the computer or central control device. After opening the RS-232 serial port connection, set the parameters as follows.

Port number: COM1 (set according to the computer or central control device port number)			
Bit rate	115200	parity	no
Data bits	8	Stop bit	1

Key control codes are assigned as follows: (No return parameter TV After receiving the serial port command, the return code is written into the serial port and returned to the upper computer)

function	Control code	Return code	note
turn on	7F 08 99 A2 B3 C4 02 FF 01 00 CF	7F 09 99 A2 B3 C4 02 FF 01 00 01 CF 00	
turn off	7F 08 99 A2 B3 C4 02 FF 01 01 CF	7F 09 99 A2 B3 C4 02 FF 01 01 01 CF	

function	Control code	Return code	note
Mute	7F 08 99 A2 B3 C4 02 FF 01 02 CF	7F 09 99 A2 B3 C4 02 FF 01 01	
HD1(HDMI1) (HDMI Rear)	7F 08 99 A2 B3 C4 02 FF 01 0A CF	7F 09 99 A2 B3 C4 02 FF 01 0A 01 CF	
HD2(HDMI2) (HDMI Rear)	7F 08 99 A2 B3 C4 02 FF 01 0B CF	7F 09 99 A2 B3 C4 02 FF 01 0B 01 CF	
OPS(HDMI3)	7F 08 99 A2 B3 C4 02 FF 01 0C CF	7F 09 99 A2 B3 C4 02 FF 01 0C 01 CF	
Computer VGA	7F 08 99 A2 B3 C4 02 FF 01 0D CF	7F 09 99 A2 B3 C4 02 FF 01 0D 01 CF	
Alone to listen	7F 08 99 A2 B3 C4 02 FF 01 15 CF	7F 09 99 A2 B3 C4 02 FF 01 15 01 CF	
Return (exit)	7F 08 99 A2 B3 C4 02 FF 01 1D CF	7F 09 99 A2 B3 C4 02 FF 01 1D 01 CF	
The home page	7F 08 99 A2 B3 C4 02 FF 01 1C CF	7F 09 99 A2 B3 C4 02 FF 01 1C 01 CF	
voice —	7F 08 99 A2 B3 C4 02 FF 01 17 CF	7F 09 99 A2 B3 C4 02 FF 01 17 01 CF	
voice +	7F 08 99 A2 B3 C4 02 FF 01 18 CF	7F 08 99 A2 B3 C4 02 FF 01 18 CF	
Switch the locking status of child lock	7F 08 99 A2 B3 C4 02 FF 01 57 CF	7F 09 99 A2 B3 C4 02 FF 01 57 01 CF	

The Remote Control

Remote control buttons



Key	Function
	Functional specifications
SOURCE	Turn on/off the source list
NUMERIC KEYS	Up/down/Left/right select key
OK	Confirm the current operation
MENU KEYS	The main menu is displayed or hidden
HOME PAGE	Return to the Android launcher
RETURN	Return to the previous menu
OPS	No function
WHITEBOARD	Enter annotation mode
	Enter/exit the screen rest mode
VOL-	Reduce the volume
	Mute/unmute
VOL +	Turn up the volume

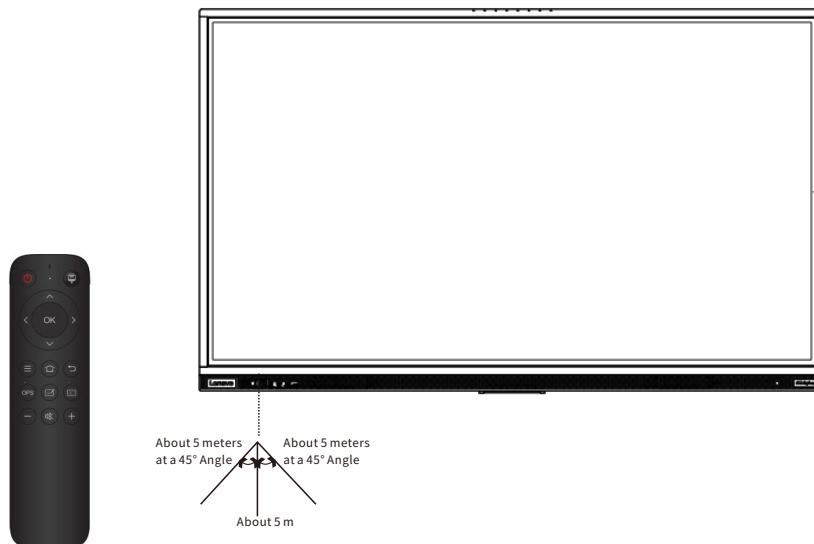

Instructions for remote Control



PAY ATTENTION TO

To avoid possible failures, read the following instructions and operate the remote control correctly.

- Do not drop or tap the remote control.
- Do not spill water or other liquids on the remote control.
- Do not place the remote control on damp objects.
- Do not spill water or other liquids on the remote control. Do not let the remote control directly exposed to the sun or near the heat source of overheating.

Use the remote control in the range of about 5 meters in front of the remote control reception of this product and about 30° Angle on both sides.

Chapter 2 Explore your smart large format display

This section describes the basic operation functions of the display.

Teams The Meeting

You can create a conference or join a conference. Users can create a conference or join a conference through the conference invitation code to achieve remote video, conversation, annotation and other operations, and achieve trans-regional and trans-network remote business communication, so that the team communication regardless of time and space, efficient video communication anytime and anywhere.





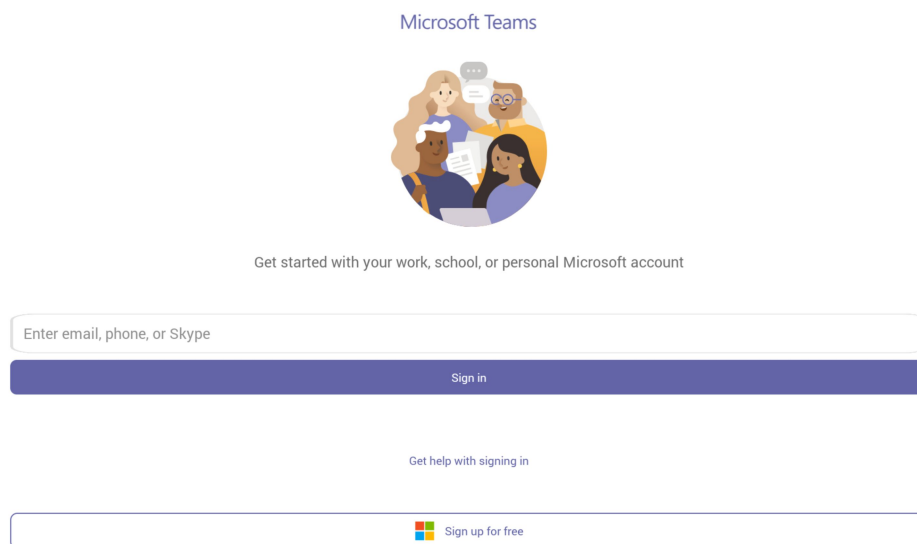

You can access the meeting page in either of the following ways:

- Click the "Meeting" icon on the home page;
- Click on the "More Apps" section and click on the "Teams" icon.



Quick Access Controls

On the home screen, click the icon  to expand all the ICONS in the floating bar.

	Expand/hide the floating bar
	Return to the Android launcher
	Return to the previous menu
	Enter annotation mode
	Source selection
	Bring up the task management sidebar

The Whiteboard

The whiteboard is designed to quickly and conveniently display the written content of a meeting to participants. Users can annotate, draw, insert flow charts and pictures on the whiteboard page.

Users can access the writing pad in the following two ways:

- On the home screen, click Whiteboard on the toolbar to go to the writing pad.
- Click Whiteboard on the More page to go to the writing pad page.

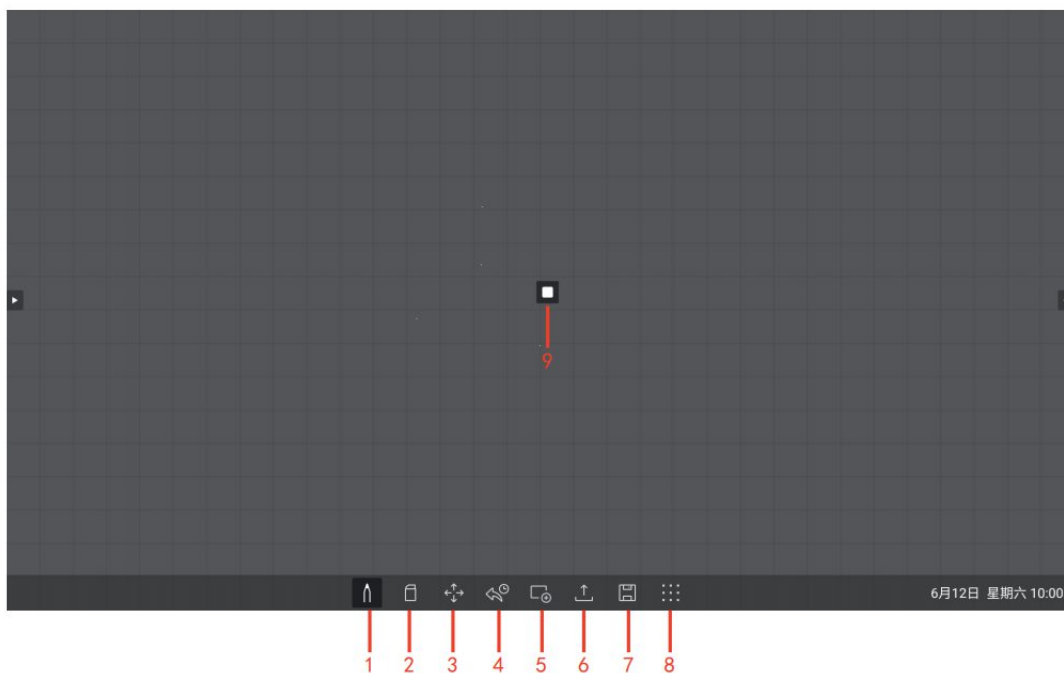

NO	Name	Functions
1	Pen	Supports preset 6 colors + universal color palette, and adjustable brightness supports whiteboard pen +Mark pen to choose two pen types: fine, medium and thick.
2	Eraser	Support small, medium and thick eraser options for partial erasing Support one-click screen clearing to clear all content gesture: support for erasing the back of the hand.
3	Thumbnail navigation	Support thumbnail display, navigation to find the desired content, support displayHeart, actual size, display all three display modes.
4	Time to go back	Unlimited step rollback is supported. All meeting contents are recorded, and single-step undo and recovery is supported.
5	Page management	Implement canvas paging 1-6 pages, can add or delete the pages.
6	A key to share	Support meeting minutes, writing notes and other content, one key scan code to view the share save, and support sharing the current window.
7	Save the source file	Supports saving whiteboard source files, you can open next time to continue editing. Support default name + manual name.

8	More	<p>Image insertion: PNG and JPG images can be inserted, the image can be adsorbed at 45 degrees, the image can be erased by eraser, and up to 4 images can be added.</p> <p>Insert documents: open third-party documents, which can be used together with large-screen comments;</p> <p>Web page insertion: support window insertion of web pages, can switch between writing mode and operation mode, and full-screen, screenshot, support insertion of a maximum of one web page;</p> <p>Open whiteboard: Open whiteboard source files for re-editing and operation.</p> <p>Whiteboard setting: set toolbar following, suspension menu, simulated brush stroke, background setting, network setting;</p> <p>About whiteboard: display the current version of whiteboard, software license agreement, open source component license, privacy statement, and support software check and update;</p> <p>Exit: Allows you to exit a meeting without trace. After a meeting, you can delete whiteboard files, system screenshots, and screen recordings with one click.</p>
9	Hover toolbar	<p>Hold the finger on the screen for more than 2 seconds and release it to call out the floating toolbar, which is convenient for users to use the whiteboard quickly. Common tools: If no operation is performed for more than 2 seconds, the floating toolbar will be automatically hidden</p>

Notation

Users can use the annotation function to annotate or modify pictures or documents on the smart large screen. In annotation mode, the system generates a transparent layer at the top of the screen. Users can add annotations to the transparent layer, save the screenshot of annotations after annotation, and repeat the operation until the annotation mode exits.

Users can enter the annotation mode in either of the following ways:

1. Click the floating bar "📏" icon;
2. In the "File Management" interface, click the "📏" icon in the lower right corner of the interface;

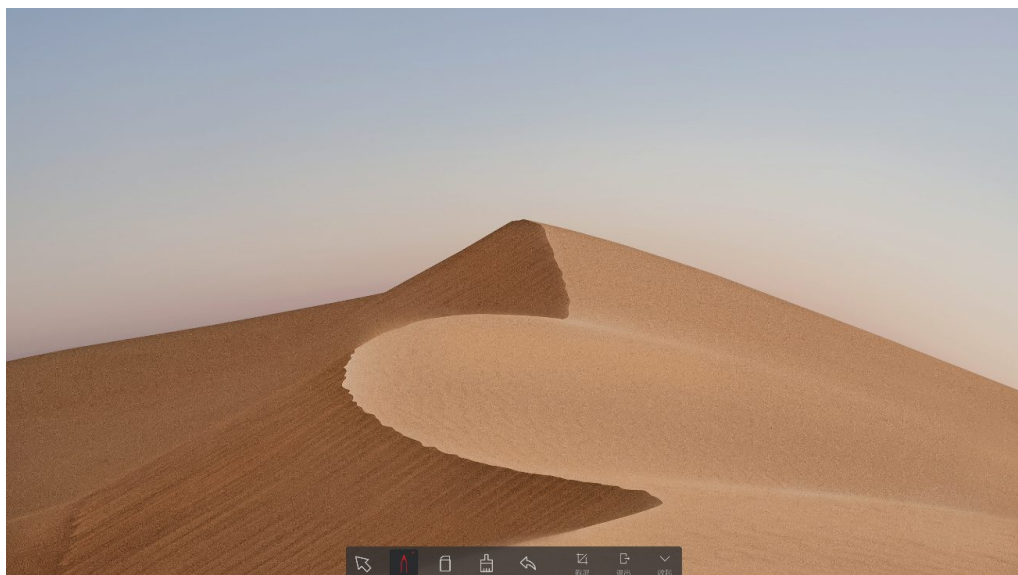

1	Choose	Click this icon to return to the current interface operation state from annotation mode.
2	The brush	Click the icon to enter the writing state. Click again to set the brush color and thickness.
3	The eraser	Click the icon to enter the eraser function, click the icon again to set the eraser diameter.
4	Clear the screen	Clear all content of the current page.
5	Undo	Return to the previous step.
6	Screenshots	Capture the current comment page, images can be selected to import whiteboard and file sharing.
7	Exit	Click the icon to exit annotation mode.
8	Pack up	Click the icon to hide the toolbar, click the hide arrow again to show the toolbar.

All Files

The file management page displays local files in the current system. If an external storage device (such as a USB storage device or a removable hard disk) is connected, the file content of the storage device is also displayed. Users can preview, filter, search, comment, and share files on the file management page. You can access the file management page in any of the following ways:

- On the home screen, click the file icon "📁".
- On the More screen, click the File "📁" icon.
- In the Task Management sidebar, click the Image Management icon;

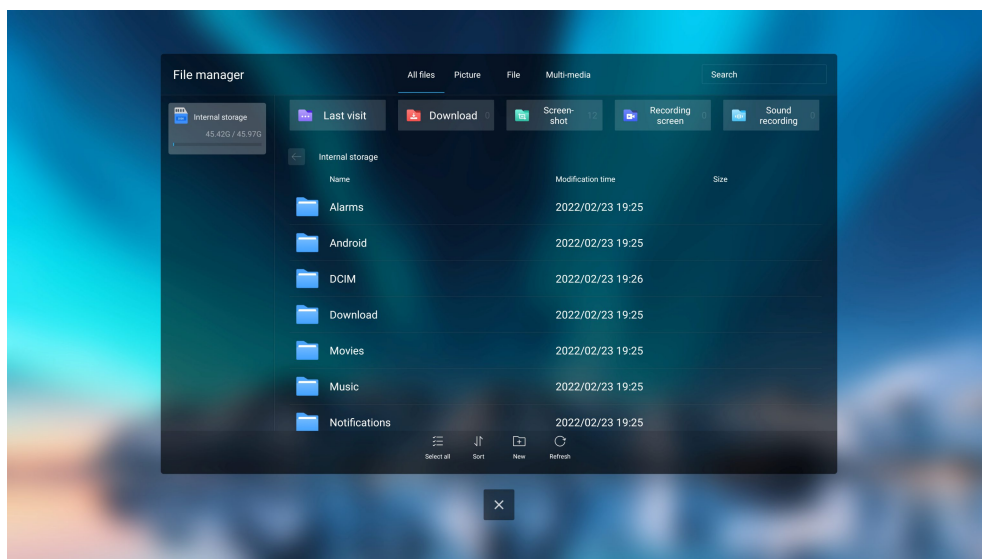

All Application

The Calculator

Click the calculator APP to enter,you can realize the following functions of add, subtract,multiply and divide as shown in the picture below.



Screenshots

You can access the screen capture screen in any of the following ways:

- Click the "Screenshot" icon of the "More" interface;
- Click the "Screenshot" icon in the task Management sidebar;
- Press the "Take a Screenshot" button on your remote control.

After entering the screenshot mode, the capture box can change the capture position by dragging the gesture, and the capture box will follow the gesture to the position where the screenshot is needed. Hold your finger on the right Angle of the capture frame and slide to narrow or enlarge the screen shot.

On the screen capture screen, click the icon "➡" to insert the current screenshot into the whiteboard, "☐" to select full screen, "✕" to exit the screenshot, and "✓" to confirm capturing the current screen.

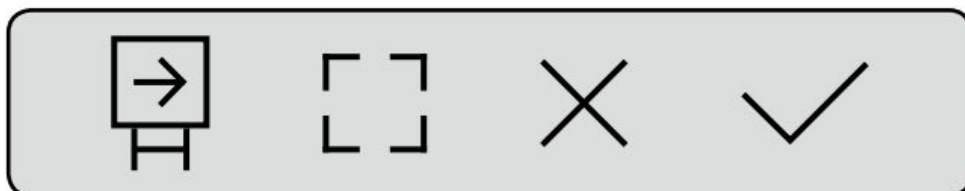

The Calendar

Click the "Calendar" icon to enter the calendar setting interface, as shown below:

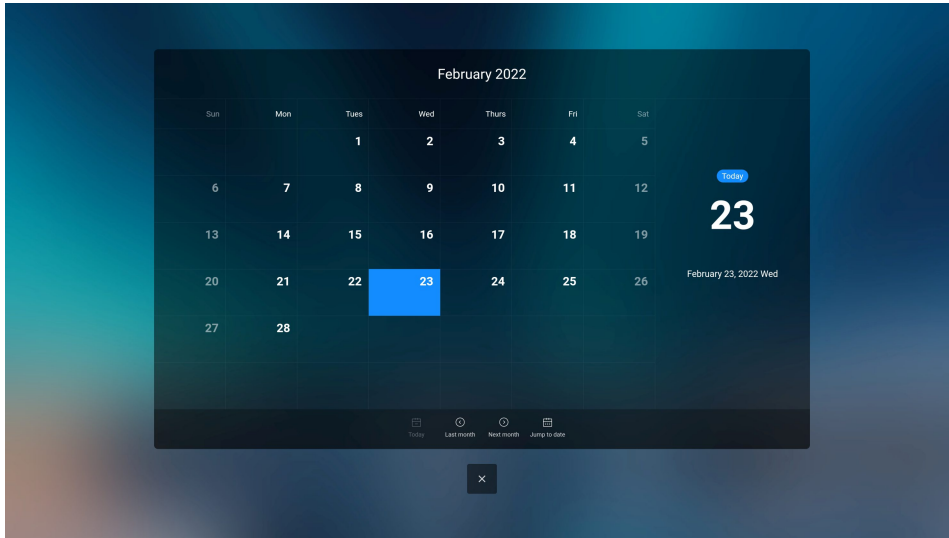

The Clock

Click the clock APP to enter, you can realize the following functions: "clock", "alarm clock", "timer" and countdown.

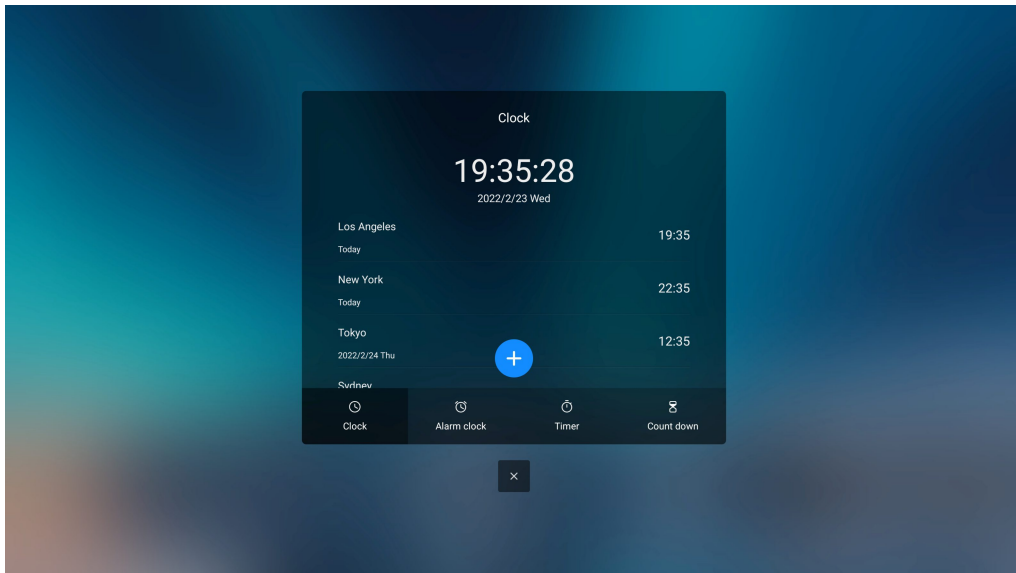

Lenovo Projection

Click the "Lenovo Projection" icon to enter the screen projector pairing display interface. Users can use the screen projector to display according to the instructions, as shown below:

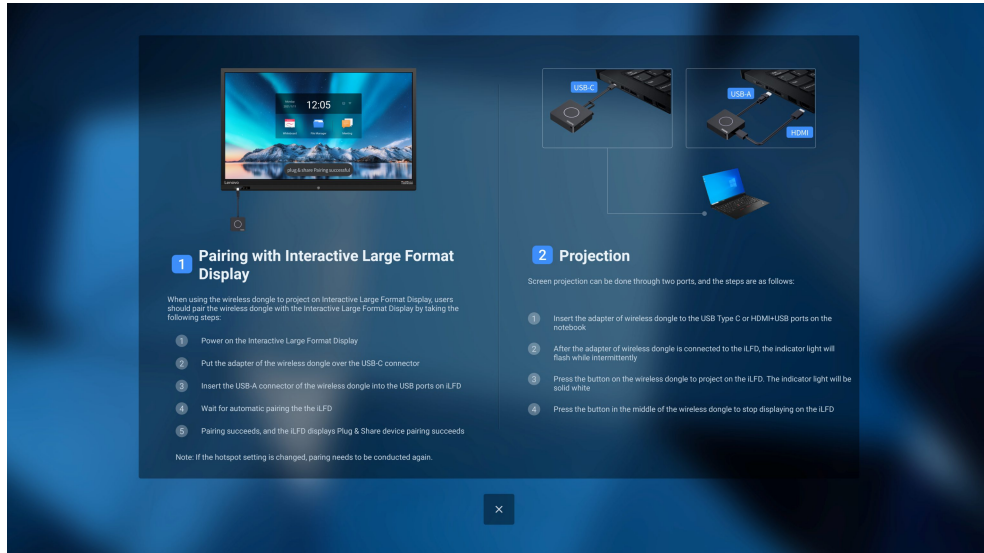

System Settings

Click the "⚙️" icon in the "More" interface to enter the setting interface, including common functions, network Settings, time and language, advanced Settings, about devices and other information.

Commonly Used Functions

Enter the "Common Functions" sub-menu, you can set wallpaper, auto brightness, brightness volume, speaker, microphone, camera functions.

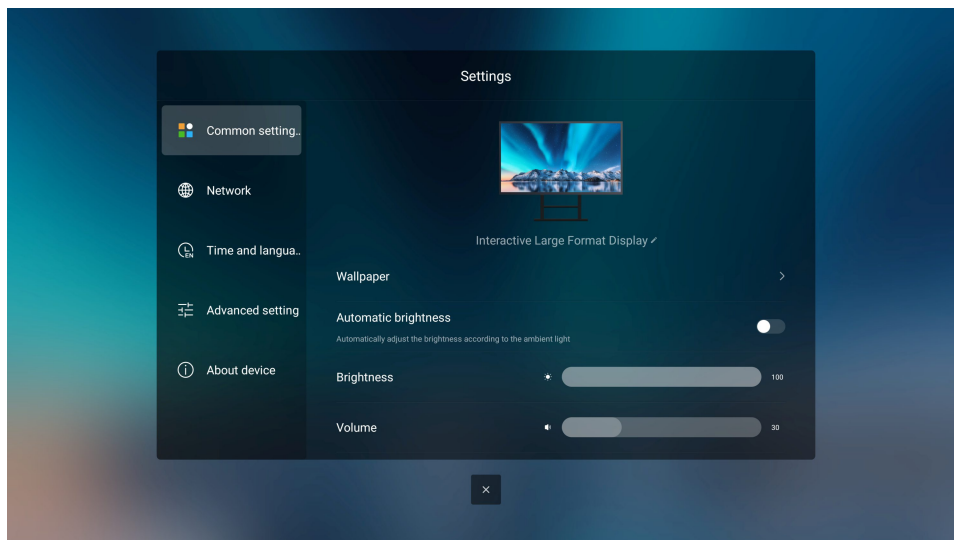

Network

The Network sub-menu is displayed, allowing you to set the wireless network, wired network, hotspot information, and Bluetooth functions.

- **Wireless network:** View the MAC address of the device and enable or disable Wi-Fi.
- **On wired networks:** View the MAC address, IP address, gateway, subnet mask, and DNS information. It can automatically obtain LAN IP or LAN IP as required.
- **Hotspot:** You can set items related to portable Wi-Fi hotspots.
- **If you use a wireless projector,** you need to turn on the wireless hotspot prompt.
- **Bluetooth:** Can be connected to enable bluetooth function.

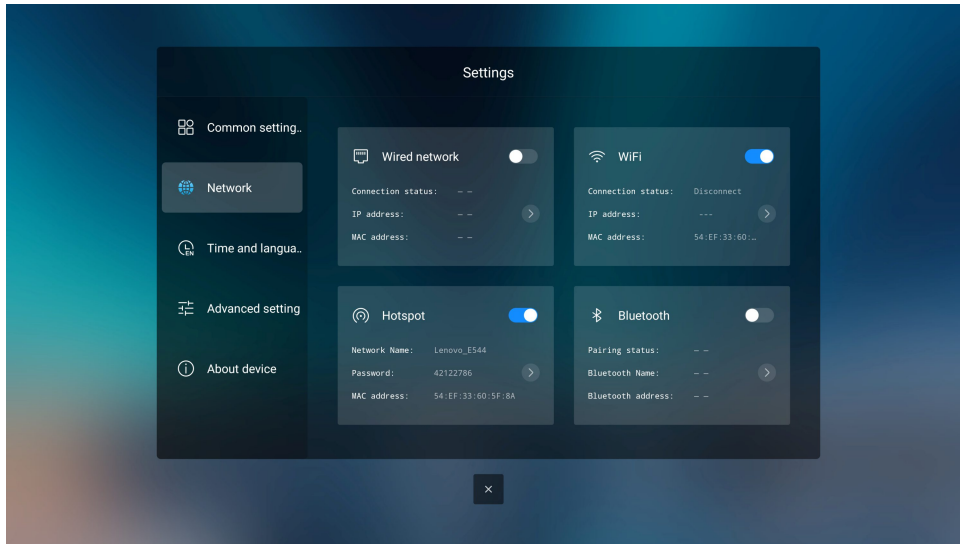

Time Language

Select "Time language" sub-menu, you can enter "Date and time, time zone", language input method

- **Period and time, time zone:** you can set the date, time, time, and time zone
- **Language and input method:** You can select a language and set different input methods

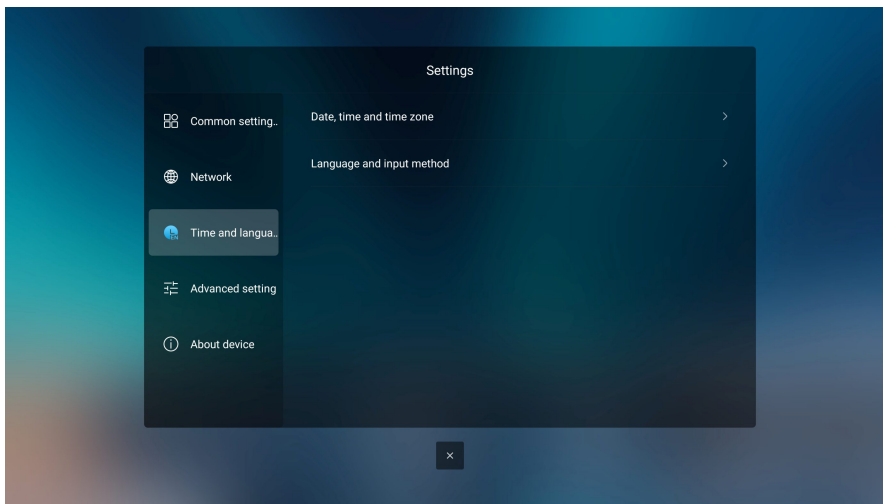

Advanced Settings

Enter the "Advanced Settings" sub-menu, you can choose "Hover menu Settings", "Sound Source Tracking", "Application Information", "Auto On/off", "Auto Sleep and Wake up Settings", "Standby", "Low Blue light mode", "Startup channel", "OPS startup", "Lock screen".

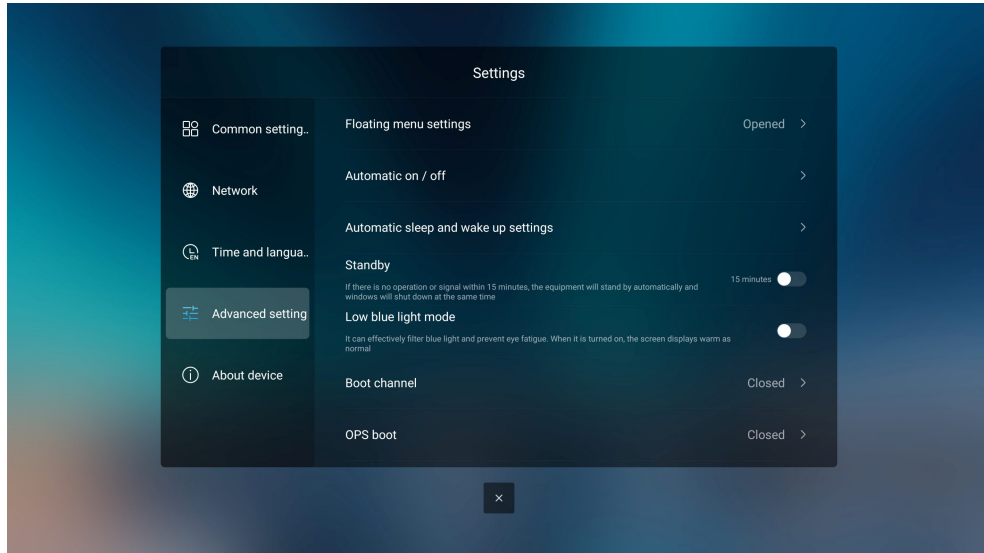

Low Blue Light

Enter the low Blue light mode: Click the "Settings" button in the sidebar and select "Advanced Settings" to enter the page. Then select the "Low Blue Light Mode" button and click to enter the low blue light mode.

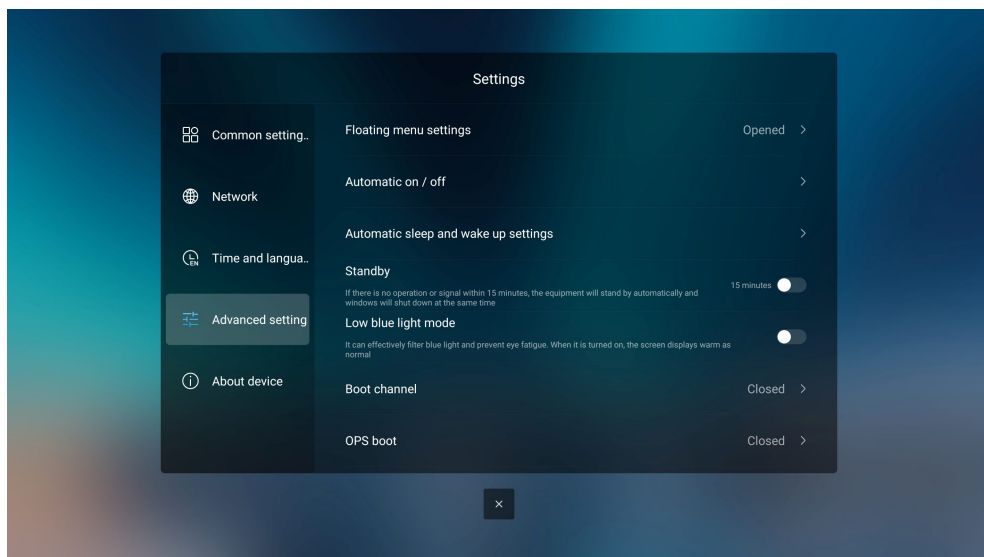

The product's "Low Blue light mode" is certified by TUV RHINeland for low blue light. The incidence of blue light problems affecting eye health has increased in recent years. Low blue light technology can reduce blue light levels. It is recommended to use low blue light mode to protect your eyes.

No Stroboscopic:



The device has no visible or invisible flicker in the range of 0-3000Hz.

About The Equipment

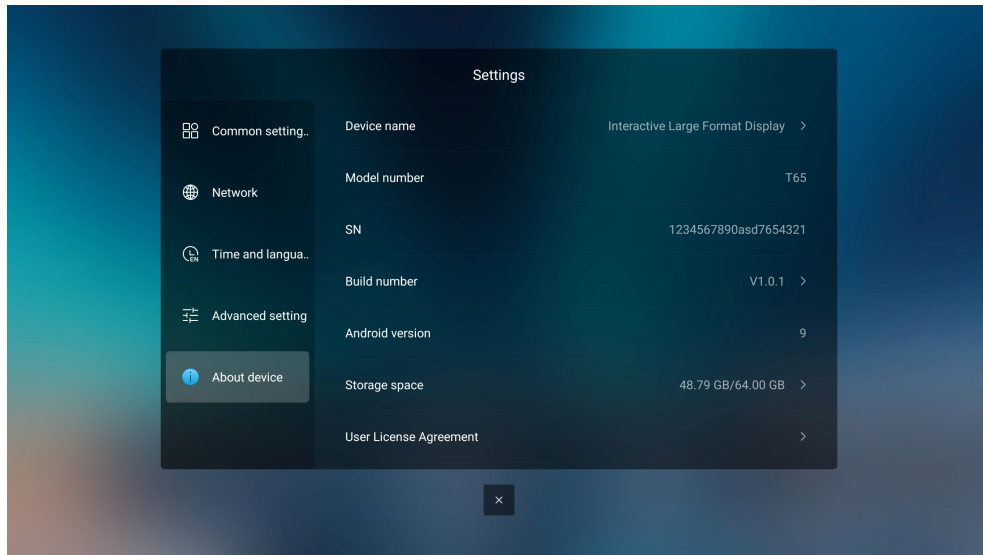
The About Device submenu is displayed. You can select system Upgrade, Android Version, Storage Space, User License Agreement, Privacy Policy, Legal Notice, factory Default



External Signal Source

Click the signal source icon "  " in the floating bar of the home page, and the system pops up the external signal port tool window (display Built-in COMPUTER、Front HDMI、front Type-C、Type-C、HDMI 1、HDMI 2、HDMI 3、DP、VGA、AV). Click the "  " icon again to close the port window. As shown below:

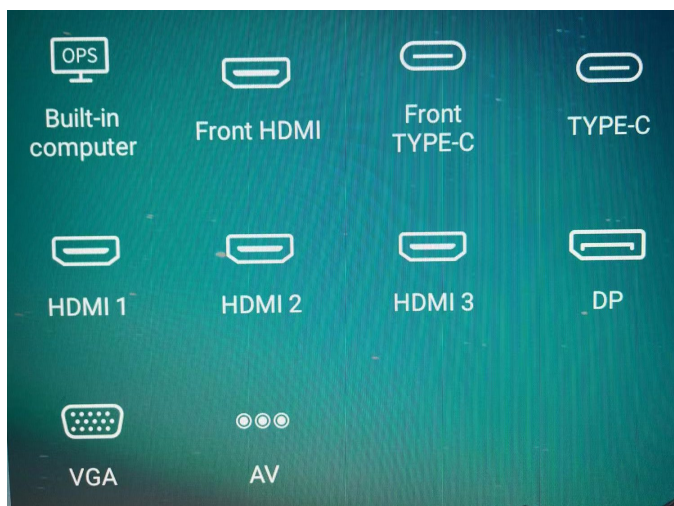

Wired signal sources include Front HDMI 、front Type-C 、Type-C 、HDMI 1 、HDMI 2 、HDMI 3 、DP 、VGA 、AV. Click the icon of signal source port, and the intelligent large screen will display the signal source screen in full screen.

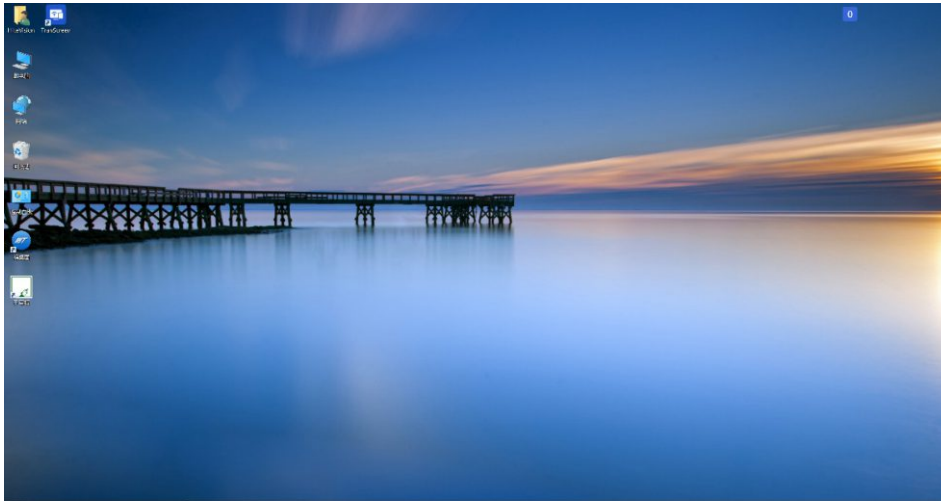

Built-In Computer

After the built-in computer is successfully installed, tap the "  " icon on the floating toolbar, and then tap the " Built-in Computer " icon to enter the built-in computer interface.

As shown below:

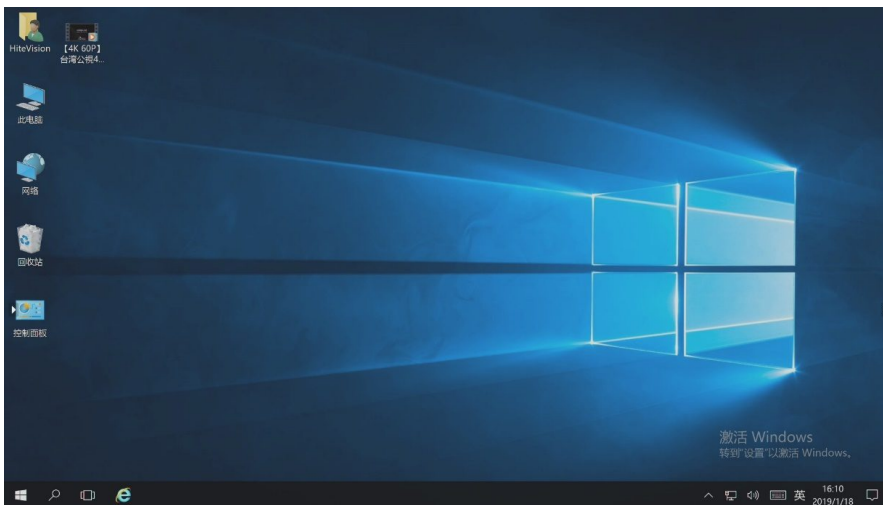

Interest Rates Screen

In response to the policy of energy conservation and environmental protection, the screen function is specially added in the design of intelligent large screen. You can set the screen rest state when you only answer the voice without viewing the screen. In this case, audio or video plays normally, the screen is off, and the power indicator is steady green.

Users can access the screen in the following two ways:

- Press the "rest screen" button of the remote control.
- Under the startup state, long press the screen with 3 fingers for more than 3 seconds.



To return to the status before the screen break, users can exit the screen break in the following three ways:

- Short press the power button;
- Press any key of remote control;
- Tap the screen to return to the previous state.

Lock Screen

In startup state, tap the "lock screen" button of the remote control to enter the lock screen state, and the lock screen icon appears on the interface, locking the screen touch function.

As shown below:

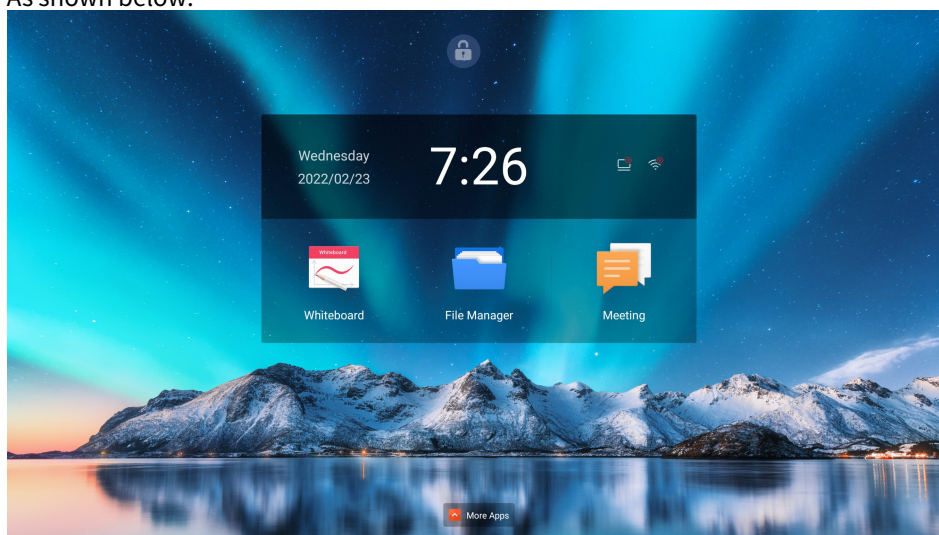

You can exit the screen-locked state in the following ways:

- Press the "lock screen" button of the remote control;
- Short press the front power button;
- Tap the screen 3 times in quick succession with your finger to restore touch control.

Resolution

VGA Display Mode

No.	Resolution	Refresh Rate
1	640X480	60Hz
2	800 x 600	60Hz
3	1024X768	60Hz
4	1360X768	60Hz
5	1920X1080	60Hz

HDMI Display Mode

No.	Resolution	Refresh Rate
1	720X480	60Hz
2	1280X720	60Hz
3	1920X1080	50Hz
4	1920X1080	60Hz
5	3840X2160	30Hz
6	3840X2160	60Hz

HDMI Out Video Output Mode

No.	Resolution	Refresh Rate
1	1920X1080	60Hz
2	3840X2160	30Hz
3	3840X2160	60Hz

Indicator	Status
Off	Shut down or power disconnected
Red	Shutdown
Red on, green flashes once every 3 seconds	Sleep mode
Green	Screen off/normal working state
Green on, red flashes once every 3 seconds	Locked screen

Chapter 3. Troubleshooting

If you have a problem setting up or using your LFD, you might be able to solve it yourself. Before calling your dealer or Lenovo, try the suggested actions that are appropriate to your problem.

Issue	Possible Factor	Solution
There's nothing on the screen, no sound, no light	The power plug is loose and the power supply is not connected	Check whether the power cable is properly connected.
Computer display image offset, unsatisfactory screen, over screen, fuzzy display	Signal interference, such as cars, neon lights, hair dryers, etc.	Find interfering electrical equipment nearby and move it away from the machine; or insert the power plug into the other socket.
Computer display image offset, unsatisfactory screen, over screen, fuzzy display	1. Improper adjustment 2. Wrong display mode	1. Use the automatic adjustment function. 2. Enter "PC Screen Adjustment" to adjust the horizontal or vertical position. 3. Use recommendation mode.
system halted, unable to operate the machine	1. Running too many programs 2. The normal operation of the machine is disturbed by the external environment (such as lightning, static electricity, etc.)	Disconnect the power supply of the machine, wait 1 to 2 minutes and then switch on the power again.
Touch is slow and malfunctioning	The machine runs too many programs	runs too many programs Clearing accounts for a larger operation of the program or restart the machine.
OPS cannot be started normally, and there is no display , no touch	OPS is not fixed	Reinstall the OPS computer.
Touch offset	Caused by computer system coordinates, corrective treatment is required.	Enter the control panel and select the correction process.
External computer touch is invalid	1. The ports of the signal source and the touch USB cable are inconsistent. 2. Touch USB cable is too long or poor quality.	1. Check and replace the interface corresponding to the touch USB cable. 2. Replace a shorter or better quality touch USB cable.

Appendix A. Important Safety Information

Safety Information

General Safety guidelines

For tips to help you use your computer safely,

go to: <http://www.lenovo.com/safety>

Before installing this product, read the Safety Information.

This equipment is not suitable for use in locations where children are likely to be present, avoid hurting your child when machine falling down.

مع، يجب قراءة دات السلامة

Antes de instalar este produto, leia as Informações de Segurança.

在安装本产品之前，请仔细阅读 **Safety Information** (安全信息)。

Prije instalacije ovog produkta obavezno pročitajte Sigurnosne Upute.

Před instalací tohoto produktu si přečtěte příručku bezpečnostních instrukcí.

Læs sikkerhedsforskrifterne, før du installerer dette produkt.

Ennen kuin asennat tämän tuotteen, lue turvaohjeet kohdasta Safety Information

Avant d'installer ce produit, lisez les consignes de sécurité.

Vor der Installation dieses Produkts die Sicherheitshinweise lesen.

Πριν εγκαταστήσετε το προϊόν αυτό, διαβάστε τις πληροφορίες ασφαλείας (safety information).

לפני שתתקין מוצר זה, קראו את הוראות הביטחון.

A termék telepítése előtt olvassa el a Biztonsági előírásokat!

Prima di installare questo prodotto, leggere le Informazioni sulla Sicurezza

製品の設置の前に、安全情報をお読みください。

본 제품을 설치하기 전에 안전 정보를 읽으십시오.

Пред да се инсталира овој продукт, прочитајте информацијата за безбедност.

Lees voordat u dit product installeert eerst de veiligheidsvoorschriften.

Les sikkerhetsinformasjonen (Safety Information) før du installerer dette produktet.

Przed zainstalowaniem tego produktu, należy zapoznać się

z książką "Informacje dotyczące bezpieczeństwa" (Safety Information).

Antes de instalar este produto, leia as Informações de Segurança.

Перед установкой продукта прочтите инструкции по технике безопасности.

Pred inštaláciou tohto produktu si prečítajte bezpečnostné informácie.

Pred namestitvijo tega proizvoda preberite Varnostne informacije.

Antes de instalar este producto lea la información de seguridad.

Läs säkerhetsinformationen innan du installerar den här produkten.

សូមអានព័ត៌មានសុវត្ថិភាព មុនពេលចាប់ផ្តើមបញ្ចូលកម្មវិធី

安裝本產品之前，請先閱讀「安全諮詢」。

Maintenance

Important Safety Information

The power cable is dedicated to the smart screen. If you want to use a different power cable, only use the power cable that matches the smart screen.



To prevent the machine from being damaged, do not use any cables other than the one provided with the machine. Please do not overload the power sockets and make sure that the sockets you use are certified by the state for safety. The socket-outlet shall be installed near the equipment and shall be easily accessible.



The power cable in the attachment is a three-socket power cable (with grounding protection). Ensure that the ground terminal of the wall socket is properly grounded. When wiring power cables, avoid channels to avoid trampling. You should also avoid areas that are squeezed by other objects.



In case of a thunderstorm, pull out the power plug and cable plug and disconnect the device from the antenna to avoid damage to the device. The disconnection from line voltage is made by pulling the mains plug.



If the product is not used for a long time, please turn off the power and unplug the power plug. If there is any abnormal sound or smell, please immediately turn off the power and unplug the power plug. If it is confirmed as abnormal, do not continue to use it. Contact the product maintenance personnel for repair as soon as possible.



Do not place inflammable and explosive objects on the machine, such as candles, electric stoves and light bulbs should not be placed on or near the machine to avoid accidents.



Be careful of liquid and metal foreign matter falling into the machine. If any liquid or metal foreign matter falling into the machine, please do not turn on the machine and contact professional personnel to deal with it as soon as possible.



After the machine is moved from a low temperature environment to a warm area, dew may occur inside the machine. In order to make the dew fully distributed and dry, it should be placed for 24 hours before powering on and starting up.



When moving the machine, it should be completed by two or more people, and the impact should be avoided during the moving process, and the display screen should be specially protected.



In order to prevent accidental injury, the machine must be installed on a flat and stable ground according to the installation instructions; or according to the wall mounting bracket installation instructions to firmly fix the machine on the wall



Do not install the machine in an improper place, such as:

- Do not install or place the machine near a heat source, or place it in direct sunlight, in a dusty or humid environment.
 - Poor ventilation or closure.
 - Storage or use of flammable and explosive materials environment.
 - An environment with flammable or corrosive gases.
-



Do not expose the battery to excessive heat, such as sunlight or fire. Otherwise, it may explode.

Appendix B. Usage Precautions

- Please do not disassemble or assemble this product by yourself in any way. Opening or removing the cover without authorization may expose you to dangerous voltage or other hazards. If you have any maintenance matters, please contact professional maintenance personnel for handling.
- If the unit is dirty, please unplug the unit and wipe it with a soft semi-dry cloth dipped in a small amount of water, do not repeatedly wipe the display to avoid scratches. Do not use alcohol, gasoline, acid, alkali, detergent, volatile oil, thinner and other solvents to wipe the machine. These solvents may cause material deterioration or damage the paint surface.
- Under the environment of high humidity, there may be water mist inside the screen, which is normal. This is due to the reason of weather humidity and temperature caused by the difference in temperature between the outer glass and the inner glass surface to produce condensation in the glass inner surface of the small water droplets. It will disappear automatically after 24 hours of normal use. Please feel free to use it.
- Do not put any sharp objects or metal objects into the cooling hole or touch the signal connector to avoid damage or electric shock caused by short circuit.
- The main material of the LCD screen is glass, which is fragile. Do not apply pressure to the LCD screen to avoid damage.
- Do not place the machine on an unstable trolley, shelf or table, which may cause the machine to tip over. The machine should be moved with care when placed on a cart. A quick and sudden stop, too much force or uneven ground can cause carts and machines to tip over.
- The openings on the machine are designed for ventilation and heat dissipation to ensure the reliable operation of the components in the machine and prevent overheating. Ventilation should not be impeded by covering such items as newspapers, tablecloths and curtains.
- Do not let the machine for a long time to display the same picture or the active picture contains a long time fixed text, icons, etc., this will leave "residual shadow" on the screen, and does not disappear in a long period of time after shutdown the machine.

Appendix C. Service and support

The following information describes the technical support that is available for your product, during the warranty period or throughout the life of the product. Refer to your Lenovo Statement of Limited Warranty for a fully Lenovo warranty termsexplanation of

Online Technical Support

Online technical support is available during the life of your product through the Lenovo Support Web site at <http://www.lenovo.com/support>

Product replacement assistance or exchange of defective components also is available during the warranty period, assistance for replacement or exchange of defective components is available. In addition, if your option is installed in a Lenovo computer, you might be entitled to service at your location. Your technical support representative can help you determine the best alternative

Telephone Technical Support

Installation and configuration support through the Customer Support Center will be withdrawn or made available for a fee, at Lenovo's discretion, 90 days after the option has been withdrawn from marketing. Additional support offerings, including step-by-step installation assistance, are available for a nominal fee.

To assist the technical support representative, have available as much of the following information as possible:

- Option name
- Option number
- Proof of purchase
- Computer manufacturer, model, serial number, and manual
- Exact wording of the error message (if any)
- Description of the problem
- Hardware and software configuration information for your system

If possible, be at your computer. Your technical support representative might want to walk you through the problem during the call.

Worldwide Telephone List

For the current phone numbers,
Go to link <https://pcsupport.lenovo.com/sk/en/premiersupport>

Service Information

Customer responsibilities

The warranty does not apply to a product which has been damaged due to accident, misuse, abuse, improper installation, usage not in accordance with product specifications and instructions, natural or personal disaster, or unauthorized alterations, repairs or modifications.

The following are examples of misuse or abuse and not covered by warranty: Images burned on to the screen of a CRT monitor. Burned image is preventable by utilizing a moving screen saver or power management. Physical damage to covers, bezel, base and cables. Scratches or punctures on monitor screens.

Getting further help

If you still can't solve your problem, please contact the Customer Support Centre. For more information on contacting the Customer Support Centre, please see Appendix C, "Service and support" on page C-1.

Service parts

Refer to Lenovo service eSupport.

Appendix D. Compliance information

Recycling Information

Lenovo encourage owners of information technology (IT) equipment to responsibly recycle their equipment when it is no longer needed. Lenovo offers a variety of programs and services to assist equipment owners in recycling their IT products. For information on recycling Lenovo products, go to:

www.lenovo.com/recycling
環境配慮に関して

本機器またはモニターの回収リサイクルについて

企業のお客様が、本機器が使用済みとなり廃棄される場合は、資源有効利用促進法の規定により、産業廃棄物として、地域を管轄する県知事あるいは、政令市長の許可を持った産業廃棄物処理業者に適正処理を委託する必要があります。また、弊社では資源有効利用促進法に基づき使用済みパソコンの回収および再利用・再資源化を行う「PC回収リサイクル・サービス」を提供しています。詳細は、
https://www.lenovo.com/jp/ja/services_warranty/recycle/pcrecycle/をご参照ください。

また、同法により、家庭で使用済みとなったパソコンのメーカー等による回収再資源化が2003年10月1日よりスタートしました。詳細は、
https://www.lenovo.com/jp/ja/services_warranty/recycle/personal/をご参照ください。

重金属を含む内部部品の廃棄処理について

本機器のプリント基板等には微量の重金属（鉛など）が使用されています。使用後は適切な処理を行うため、上記「本機器またはモニターの回収リサイクルについて」に従って廃棄してください。

Collecting And Recycling A Disused Lenovo Computer Or Monitor

If you are a company employee and need to dispose of a Lenovo computer or monitor that is the property of the company, you must do so in accordance with the Law for Promotion of Effective Utilization of Resources. Computers and monitors are categorized as industrial waste and should be properly disposed of by an industrial waste disposal contractor certified by a local government. In accordance with the Law for Promotion of Effective Utilization of Resources, Lenovo Japan provides, through its PC Collecting and Recycling Services, for the collecting, reuse, and recycling of disused computers and monitors. For details, visit the Lenovo Web site at

https://www.lenovo.com/jp/ja/services_warranty/recycle/pcrecycle/. Pursuant to the Law for Promotion of Effective Utilization of Resources, the collecting and recycling of home-used computers and monitors by the manufacturer was begun in October 1, 2003. This service is provided free of charge for home-used computers sold after October 1, 2003. For details, visit the Lenovo Web site at https://www.lenovo.com/jp/ja/services_warranty/recycle/personal/.

Disposing Of Lenovo Computer Components

Some Lenovo computer products sold in Japan may have components that contain heavy metals or other environmental sensitive substances. To properly dispose of disused components, such as a printed circuit board or drive, use the methods described above for collecting and recycling a disused computer or monitor. Lenovo may not offer the products, services, or features discussed in this document in all countries. Consult your local Lenovo representative for information on the products and services currently available in your area. Any reference to a Lenovo product, program, or service is not intended to state or imply that only that Lenovo product, program, or service may be used. Any functionally equivalent product, program, or service that does not infringe any Lenovo intellectual property right may be used instead. However, it is the user's responsibility to evaluate and verify the operation of any other product, program, or service.

Lenovo may have patents or pending patent applications covering subject matter described in this document. The furnishing of this document does not give you any license to these patents. You can send license inquiries, in writing to: Lenovo (United States),inc. 1009 Think Place – Building One Morrisville, NC 27560

U.S.A.

Attention: Lenovo Director of Licensing

LENOVO PROVIDES THIS PUBLICATION “AS IS” WITHOUT WARRANTY OF ANY KIND, EITHER EXPRESS OR IMPLIED, INCLUDING, BUT NOT LIMITED TO THE IMPLIED WARRANTIES OF NON-INFRINGEMENT, MERCHANTABILITY OR FITNESS FOR A PARTICULAR PURPOSE.

Some jurisdictions do not allow disclaimer of express or implied warranties in certain transactions, therefore, this statement may not apply to you.

This information could include technical inaccuracies or typographical errors. Changes are periodically made to the information herein; these changes will be incorporated in new editions of the publication. Lenovo may make improvements and/or changes in the product(s) and/or the program(s) described in this publication at any time without notice.

The products described in this document are not intended for use in implantation or other life support applications where malfunction may result in injury or death to persons. The information contained in this document does not affect or change Lenovo product specifications or warranties. Nothing in this document shall operate as an express or implied license or indemnity under the intellectual property rights of Lenovo or third parties. All information contained in this document was obtained from specific environments and presented as an illustration. The result obtained in other operating environments may vary.

Lenovo may use or distribute any of the information you supply in any way it believe appropriate without incurring any obligation to you.

Any references in this publication to non-Lenovo Web sites are provided for convenience only and do not in any manner serve as an endorsement of those Web sites. The materials at those Web sites are not part of the materials for this Lenovo product, and use of those Web sites is at your own risk.

Any performance data contained herein was determined in a controlled environment. Therefore, the result obtained in other operating environments may vary significantly. Some measurements may have been made on development-level systems and there is no guarantee that these measurements will be the same on generally available systems. Furthermore, some measurements may have been estimated through extrapolation. Actual results may vary. Users of this document should verify the applicable data for their specific environment.

Trademarks

The following terms are trademarks of Lenovo in the United States, other countries, or both:

Lenovo

ThinkVision

Microsoft, Windows, and Windows NT are trademarks of the Microsoft group of companies. Other company, product, or service names may be trademarks or service marks of others.