

Lenovo Y27q-30 User Guide

Product numbers

F22270QY0

66F7-GAC3-WW



First Edition (June 2022)

© Copyright Lenovo 2022.

LENOVO products, data, computer software, and services have been developed exclusively at private expense and are sold to governmental entities as commercial items as defined by 48 C.F.R. 2.101 with limited and restricted rights to use, reproduction and disclosure.

LIMITED AND RESTRICTED RIGHTS NOTICE: If products, data, computer software, or services are delivered pursuant a General Services Administration “GSA” contract, the use, reproduction, or disclosure is subject to restrictions set forth in Contract No. GS-35F-05925.

Contents

Product numbers	i
Safety information	iii
General Safety guidelines	iii
Chapter 1. Getting Started	1-1
Shipping contents	1-1
Notice for use	1-2
Product overview	1-2
Adjustment type	1-2
Tilt	1-2
Swivel	1-3
Height Adjustment	1-3
Monitor Pivot	1-3
Monitor controls.....	1-4
Cable lock slot.....	1-4
Setting up your monitor	1-5
Connecting and turning on your monitor.....	1-5
Registering your option.....	1-9
Chapter 2. Adjusting and Using the Monitor	2-1
Comfort and accessibility	2-1
Arranging your work area	2-1
Positioning your monitor	2-1
Quick tips for healthy work habits.....	2-2
Accessibility information.....	2-2
Adjusting your monitor image	2-3
Using direct access controls.....	2-3
Using On-Screen Display (OSD) controls.....	2-4
Selecting a supported display mode.....	2-7
Understanding power management.....	2-8
Power Management Modes.....	2-8
Caring for your monitor	2-9
Detaching the monitor base and stand	2-9
Wall Mounting (Optional).....	2-9
Chapter 3. Reference Information	3-1
Monitor specifications	3-1
Troubleshooting	3-3
Manually installing the monitor driver	3-5
Installing the monitor driver in Windows 7	3-5
Installing the monitor driver in Windows 10	3-6
Installing the monitor driver in Windows 11	3-7
Getting further help.....	3-7
Service information.....	3-8
Customer responsibilities.....	3-8
Appendix A. Service and Support	A-1
Registering your option.....	A-1
Online technical support	A-1
Telephone technical support.....	A-1
Appendix B. Notices	B-1
Recycling information	B-2
Trademarks.....	B-2
Power cords and power adapters.....	B-3

Safety information

General Safety guidelines

For tips to help you use your computer safely, go to:
<http://www.lenovo.com/safety>

Before installing this product, read the Safety Information.



DANGER

To avoid shock hazard:

- Do not remove the covers.
- Do not operate this product unless the stand is attached.
- Do not connect or disconnect this product during an electrical storm.
- The power cord plug must be connected to a properly wired and grounded power outlet.
- Any equipment to which this product will be attached must also be connected to properly wired and grounded power outlets.
- To isolate the monitor from the electrical supply, you must remove the plug from the power outlet. The power outlet should be easily accessible.

To take special precautions to avoid the introduction of hazards when operating, installing, servicing, transporting or storing equipment, the necessary instructions shall be made available. To reduce the risk of electric shock, do not perform any servicing other than that contained in the operating instructions unless you are qualified to do so.

Handling:

- If your monitor weighs more than 18 kg (39.68 lb), it is recommended that it be moved or lifted by two people.

Chapter 1. Getting Started

This User's Guide provides detailed operation instructions for the user. For quick instruction overview, please see the Setup Poster for brief information.

Lenovo Y27q-30 supports Lenovo Display Control Center - Artery.

Shipping contents

The product package should include the following items:

- Information Flyer
- Lenovo Limited Warranty Booklet
- Flat Panel Monitor
- Power Cord
- DP Cable
- USB 3.0 Cable
- Base
- Stand

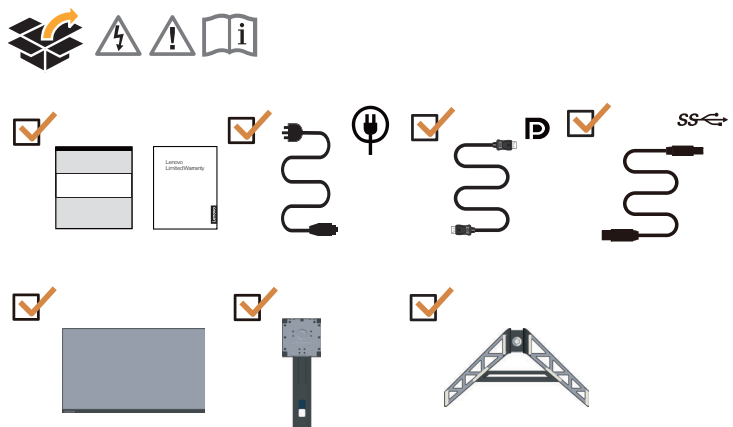

*: Depending on many factors such as the processing capability of peripheral devices, file attributes, and other factors related to system configuration and operating environments, the actual transfer rate using the various USB connectors on this device will vary and is typically slower than the data rates as defined by the respective USB specifications: - 5 Gbit/s for USB 3.2 Gen 1; 10 Gbit/s for USB 3.2 Gen 2 x 2 Gbit/s for USB 3.2.

Notice for use

To set up your monitor, please see the illustrations below.

Note: Do not touch the screen of the monitor. The screen is made of glass and can be damaged by rough handling or excessive pressure.

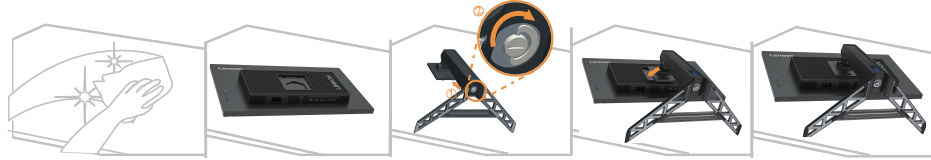

1. Place your monitor with the screen face down on a soft flat surface.
2. Insert the base towards the stand until it locks in place.
3. Align the stand assembly bracket to the monitor.

Note: To connect VESA mounting accessories, refer to “Wall Mounting (Optional)” on page 2-9.

Product overview

In this section, we will describe how to adjust the position of the monitor; how to set user controls; how to use the cable lock slot.

Adjustment type

Tilt

Please see the illustration below for an example of the tilt range.

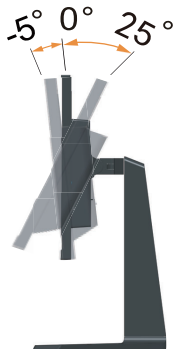

Swivel

With the built-in pedestal, you can tilt and swivel the monitor for the most comfortable viewing angle.



Height Adjustment

For height adjustment, user needs to press down or lift up the monitor.

135mm



Monitor Pivot

- Adjust the screen position before rotating the monitor screen. (Make sure that the monitor screen ascent to its highest point, and it inclines backward at 25°.)
- then rotate clockwise /counterclockwise until the monitor stops at 90°

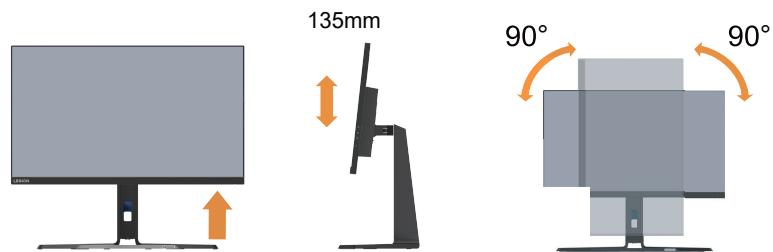

Monitor controls

The keypad controls on the panel frame are accesses to various functions.

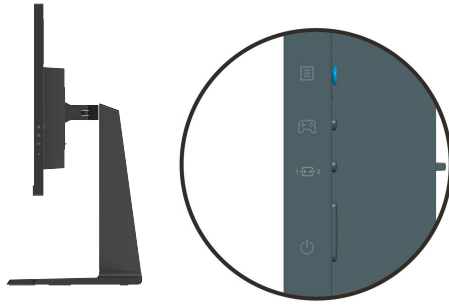

For information on how to utilize these keypad controls, please see “Adjusting your monitor image” on page 2-3.

Cable lock slot

Your monitor is equipped with a cable lock slot located on the rear of your monitor (in the lower position).



Setting up your monitor

This section provides information on how to set up your monitor.

Connecting and turning on your monitor

Note: Before performing this procedure, be sure to read “Safety information” on page iii.

1. Power off your computer and all attached devices, then unplug the computer power cord.



2. Connect the cables according to below icon indication.

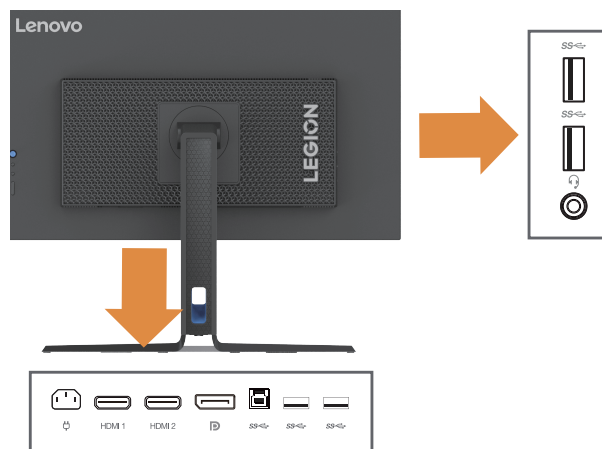

3. Connect one end of the HDMI cable to the monitor HDMI connector and the other end to the computer.

HDMI



Note: Lenovo recommends that customers who require to use the HDMI input on their monitors purchase the “Lenovo HDMI to HDMI Cable OB47070” website: www.lenovo.com/support/monitoraccessories.

4. Connect one end of the DP cable to the DP input port of the monitor and the other end of the DP cable to the computer.

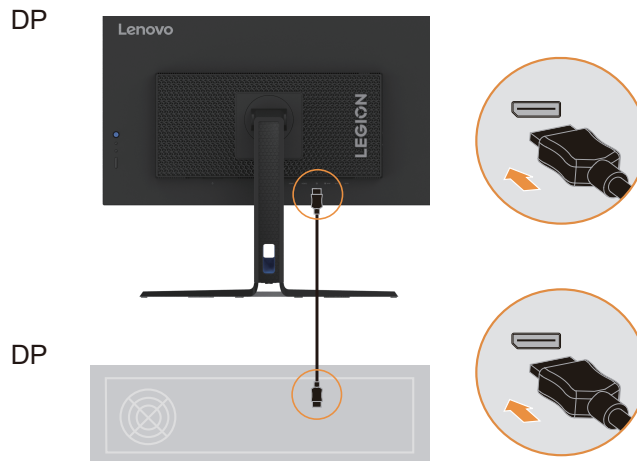

Note: Lenovo recommends users who need to use the DP cable on their monitors to purchase the “Lenovo DisplayPort to DisplayPort cable 0A36537” website: www.lenovo.com/support/monitoraccessories.

5. Connect the audio cable of the sound box and the audio jack of the monitor to transmit audio sources from DP and HDMI.

Note: The audio outputs in DP, HDMI modes.

Please be aware that excessive and/or extreme volume might damage your hearing ability.

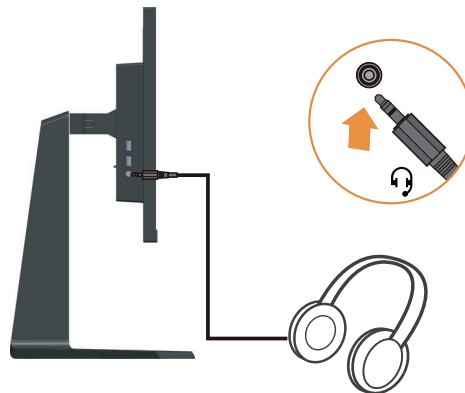

6. Connect one end of the USB cable to the USB upstream terminal on the back of the monitor, and connect the other end of the USB cable to an appropriate USB port on your computer.

SS<->* *



7. Connect one end of the USB cable to the USB downstream terminal on the side of the monitor, and connect the other end of the USB cable to an appropriate USB port on your device.

Note:

1. The USB downstream port does not provide power while the monitor is switched off.
2. Power output for USB-A: 5V/0.9A.

SS<->* *

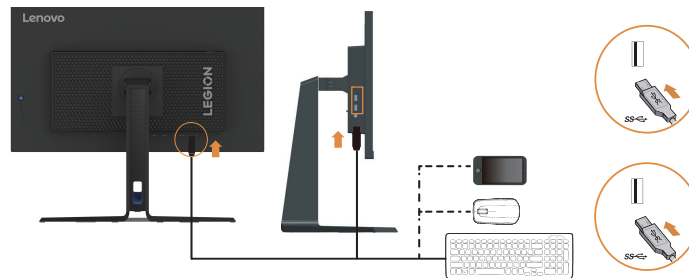

8. Plug the power cord into the monitor, and then plug the monitor power cord and computer cord into a grounded power outlet.

Note:

A certified power supply cord has to be used with this equipment. The relevant national (regional) installation and/or equipment regulations shall be considered. The certified power cord used should not be lighter than the ordinary PVC flexible cord specified by IEC 60227 (marking H05VV-F 3G 0.75mm² or H05VVH2-F2 3G 0.75mm²). According to IEC 60245 (marking H05RR-F 3G 0.75mm²), synthetic rubber cord should be used.

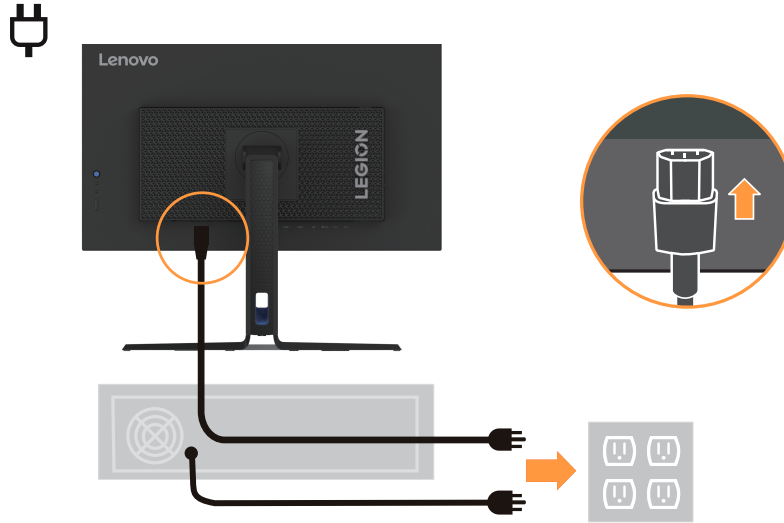

9. Connect the cables with cable clip.



10. Power on the monitor and the computer.

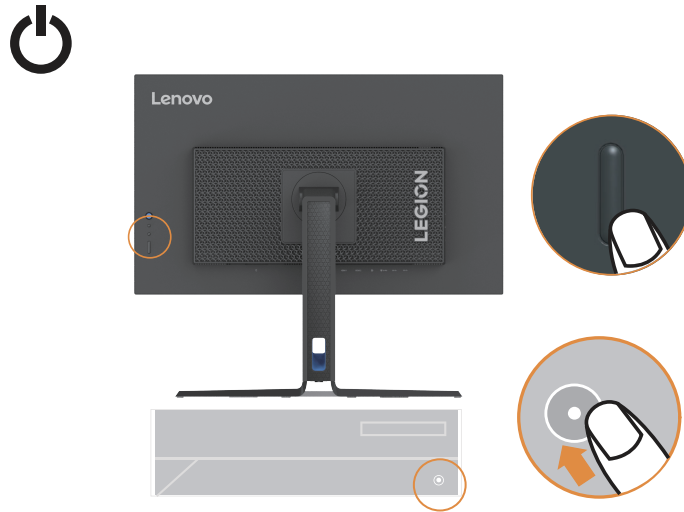

11. When you install the monitor driver, download the driver that corresponds to your monitor model from the Lenovo website https://pcsupport.lenovo.com/solutions/y27q_30. Refer to the “Manually installing the monitor driver” on page 3-5 section to install the driver.



Registering your option

Thank you for purchasing this Lenovo™ product. Please take a few moments to register your Product and provide us with information that will help Lenovo to better serve you in the future. Your feedback is valuable to us in developing products and services, as well as in developing better ways to communicate with you. Register your option on the following Website:

<http://www.lenovo.com/register>.

Lenovo will send you information and updates on your registered product unless you indicate on the Web site questionnaire that you do not want to receive further information.

Chapter 2. Adjusting and Using the Monitor

This section will give you information on adjusting and using your monitor.

Comfort and accessibility

Good ergonomic design is important to get the most from your personal computer and to avoid discomfort. Arrange your workplace and the equipment you use to suit your individual needs and the kind of work that you perform. In addition, use healthy work habits to maximize your performance and comfort while using your computer. For more detailed information on any of these topics, visit the Healthy Computing Website at: <http://www.lenovo.com/healthycomputing/>.

Arranging your work area

Use a work surface of appropriate height and sufficient working area to allow you to work in comfort. Organize your work area to match the way you use materials and equipment. Keep your work area clean and clear for the materials that you typically use and place the items that you use most frequently, such as the computer mouse or telephone, within the easiest reach.

Equipment layout and setup play a large role in your working posture. The following topics describe how to optimize equipment setup to achieve and maintain good working posture.

Positioning your monitor

Position and adjust your computer monitor for comfortable viewing by considering the following items:

- **Viewing distance:** Recommended viewing distance between the eye and the monitor screen is 1.5 x the diagonal of the screen. Solutions in meeting this required distance in cramped office situations include pulling the desk away from the wall or divider to make room for the monitor, using flat panel or compact displays to place the monitor in the desk corner, or placing the keyboard in an adjustable drawer to create a deeper working surface.

1.5 times of screen diagonal



- **Monitor height:** Position the monitor so your head and neck are in a comfortable and neutral (vertical, or upright) position. If your monitor does not have height adjustments, you might have to place books or other sturdy objects under the base of the monitor to achieve the desired height. A general guideline is to position the monitor such that the top of the screen is at or slightly below your eye-height when you are comfortably seated. However, be sure to optimize your monitor height so the line of site between your eyes and the center the monitor suits your preferences for visual distance and comfortable viewing when your eye muscles are in a relaxed state.
- **Tilt:** Adjust the tilt of your monitor to optimize the appearance of the screen content and to accommodate your preferred head and neck posture.
- **General location:** Position your monitor to avoid glare or reflections on the screen from overhead lighting or nearby windows.

The following are some other tips for comfortable viewing of your monitor:

- Use adequate lighting for the type of work you are performing.
- Use the monitor brightness, contrast controls (if equipped) to optimize the image on your screen to meet your visual preferences.
- Keep your monitor screen clean so you can focus on the screen's contents.

Any concentrated and sustained visual activity can be tiring for your eyes. Be sure to periodically look away from your monitor screen and focus on a far object to allow your eye muscles to relax. If you have questions on eye fatigue or visual discomfort, consult a vision care specialist for advice.

Quick tips for healthy work habits

The following information is a summary of some important factors to consider to help you remain comfortable and productive while you use your computer.

- **Good posture starts with equipment setup:** The layout of your work area and the setup of your computer equipment have a large effect on your posture while using your computer. Be sure to optimize the position and orientation of your equipment by following the tips outlined in “Arranging your work area” on page 2-1 so you can maintain a comfortable and productive posture. Also, be sure to use the adjustment capabilities of your computer components and office furniture to best suit your preferences now and as your preferences change over time.
- **Minor changes in posture can help avoid discomfort:** The longer you sit and work with your computer, the more important it is to observe your working posture. Avoid assuming any one posture for an extended period of time. Periodically make minor modifications in your posture to help deter any discomforts that might arise. Make use of any adjustments that your office furniture or equipment provide to accommodate changes in posture.
- **Regular short breaks help ensure healthy computing:** Because computing work is mainly static activity, short breaks during work are especially important. Periodically, stand up from your work area, stretch, walk around or have a drink etc., to take a short break from using your computer. A short break from work gives your body a welcome change in posture and helps to ensure you remain comfortable and productive while working.

Accessibility information

Lenovo is committed to providing greater access to information and technology to people with disabilities. With assistive technologies, users can access information in the way most appropriate to their disability. Some of these technologies are already provided in your operating system; others can be purchased through vendors or accessed at:











https://lenovo.ssbartgroup.com/lenovo/request_vpat.php

Adjusting your monitor image

This section describes the control features to adjust your monitor images.

Using direct access controls

Direct access controls can be used when the On-Screen Display (OSD) is not displayed.

	Icon	Control	Description
1		Power (Under any situation)	DC Off / On
2		Menu (No menu on the screen)	Opens the main menu
		Enter (Main menu)	Enters the next menu OK
		Increase (Main menu)	1. Press to Increase current value on adjustment bar 2. Press and hold for 3 seconds, and then the adjustment bar will increase by 10 units. Press and hold for 5 seconds, and then the number of the adjustment bar will hit the maximum.
		Volume (No menu on the screen)	Quickly enters the Volume adjustment page
		Decrease (Main menu)	1. Press to decrease current value on adjustment bar. 2. Press and hold for 3 seconds, and then the adjustment bar will increase by 10 units. Press and hold for 5 seconds, and then the number of the adjustment bar will hit the minimum.
		Volume (No menu on the screen)	Quickly enters the Volume adjustment page
		Back Exit(Main menu)	Returns to the previous menu Exits the menu
		Up (Main menu)	Moves the cursor up
		Brightness (No menu on the screen)	Quickly enters the Brightness adjustment page
		Down (Main menu)	Moves the cursor down
		Brightness (No menu on the screen)	Quickly enters the Brightness adjustment page
	3		Game Mode (No menu on the screen)
4		Input Source (No menu on the screen)	Quickly enters the Input Source adjustment page
		OSD locked/un-locked	Press and hold for 10 seconds ,then Main menu will be Locked/un-Locked.

Using On-Screen Display (OSD) controls

To adjust the settings, the user controls can be viewed through the OSD.

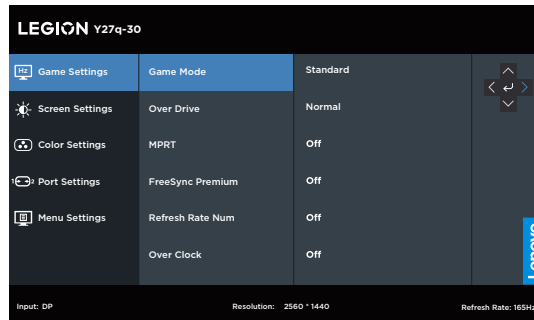

To use the controls:













1. Press  to open the main OSD menu.
2. Use  or  to move among the icons. Select an icon and press  to access the selected function. If there is a sub-menu, you can move between options using  or , then press  to select that function. Use  or  to make adjustments then press  to save.
3. Press  to move backwards through the sub-menus and exit from the OSD.
4. Press and hold  for 10 seconds to lock the OSD. This will prevent accidental adjustments to the OSD. Press and hold  for 10 seconds to unlock the OSD and allow adjustments to the OSD.

Table 2-1. OSD functions





OSD Icon on Main Menu	Sub menu	Description	Controls and Adjustments	
 Game Settings	Game Mode	[Standard]	All input ports	
		Standard		
		FPS1: First person shooter 1 mode.		
		FPS2: First person shooter 2 mode.		
		Racing: Racing mode		
		RTS: Real-Time-Strategy mode.		
		Game1: [Brightness/Over Driver/Contrast/Relative Gamma]		
	Game2: [Brightness/Over Driver/Contrast/Relative Gamma]			
	Over Drive	Respond time enhancement	Only DP port	
		[Level 2] Off / Level 1 / Level 2 / Level 3 / Level 4		
MPRT	[Off] Off/On			
FreeSync Premium	[Auto] Off/Auto			
Refresh Rate Num	Display the panel's current refresh rate on the screen. [Off] Off/Left Top/Right Top/Left Bottom/Right Bottom			
Over Clock	[Off]Off / On (Support 180Hz)			
 Scree Settings	Brightness	Adjusts overall screen brightness. [75]0~100	All input ports	
	Contrast	Adjusts difference between light and dark areas. [75]0~100		
	DCR	[Off]Off/ On		
	HDR	[Auto]Auto / HDR Photo / HDR Movie / HDR Game / HDR 400 / HDR Off		
	Dark Boost	[Level 4]Level 1/Level 2/Level 3/Level 4		
	Scaling Mode	[Full Screen]		
		Full Screen Original AR		
	Sharpness	[50]0~100		
Relative Gamma	[Default]-0.4/-0.2/Default/+0.2/+0.4/Off			
 Color Settings	Color Temp.	[Warm]	All input ports	
		Warm		
		Neutral		
		Cool		
		User(Select this option to enter the next page)		
	6-axis Color	6-axis Hue (Red Color/Green Color/Blue Color/Cyan Color/Yellow Color/ Magenta Color/Reset)		
		6-axis Saturate (Red Color/Green Color/Blue Color/Cyan Color/Yellow Color/ Magenta Color/Reset)		
sRGB	[Off]Off/ On			

Table 2-2. OSD functions

OSD Icon on Main Menu	Submenu	Description	Controls and Adjustments
 Port Settings	Input Signal	Auto Switch Input The input will automatically switch to the next available input when: There is no input signal present. The time out period has expired. [Enable] Check box	All input ports
		DP	
		HDMI1	
		HDMI2	
	USB Charging	[Off]Off/ On	
	DP	[DP1.4]DP1.2 / DP1.4	Only DP port
 Menu Settings	Information	Model:Lenovo Legion Y27q -30	All input ports
		Firmware:Ex.L1.0	
		SN:Ex.V0000001	
		HDR:Ex.Auto	
		Mode:Ex.FPS1	
		Format:Ex.8bpc RGB444	
	Language	Changes languages of menu. Note: The selected language only affects the language of the OSD. It has no effect on any software running on the computer.	
	Volume	[50]0~100	
	Button Repeat Rate	[Default]Default/Slow/Off	
	LED Indicator	[On]Off/ On	
	OSD Timeout	Set the duration of time that the OSD will remain active when no operation is performed. [10]5~60(1 seconds per unit)	
	Menu Position	[0]0~100	
	Transparency	[0]0/20/40/60/80/100	
DDC/CI	[On]Off/ On		
Reset All Settings	Reset monitor to the original settings.		
*The use of Level 4 (Over Driver) may result in reduced display quality when fast moving video graphics are displayed. Users should check Level 4 (Over Driver) to verify if it is compatible with any applications they would like to use it with. *Overclocking time out in 30min to avoid unstable. The refresh rate will revert to the normal value. Lenovo recommends a direct connection for this function. Please do not use an adapter cable or adapter.			

Selecting a supported display mode

The display mode of the monitor uses is controlled by the computer. Therefore, refer to your computer documentation on how to change display modes.

The image size, position and shape might be changed when the display mode changes. This is normal and the image can be re-adjusted using automatic image setup and the image controls.

Unlike CRT monitors, which require a high refresh rate to minimize flicker, LCD or Flat Panel technology is inherently flicker-free.

Note: If your system has previously been used with a CRT monitor and is currently configured to a display mode outside the range of this monitor, you may need to reattach the CRT monitor temporarily until you have re-configured the system; preferably to 2560 x 1440 at 165 Hz, which is a common display mode.

The display modes shown below have been optimized at the factory.

Table 2-2. Factory set display modes

Address ability	Refresh rate
720 x 400	70 Hz
640 x 480	60 Hz, 72 Hz, 75 Hz
800 x 600	60 Hz, 72 Hz, 75 Hz
1024 x 768	60 Hz, 70 Hz, 75 Hz
1280 x 1024	60 Hz, 70 Hz, 75 Hz
1440 x 900	60 Hz
1600 x 900	60 Hz, 75 Hz
1680 x 1050	60 Hz
2560 x 1440	120Hz,144Hz,165Hz,180Hz(Over Clock)
480p	60 Hz
576p	50 Hz
720p	50 Hz, 60 Hz
1080p	50 Hz, 60 Hz,120Hz
1080i	50 Hz, 60 Hz

Understanding power management

Power management is invoked when the computer recognizes that you have not used your mouse or keyboard for a user-definable period. There are several states as described in the table below.

For optimal performance, switch off your monitor at the end of each working day, or whenever you expect to leave it unused for long periods during the day.

Table 2-3. Power indicator

State	Power Indicator	Screen	Restoring Operation
On	White	Normal	
Standby/Suspend	Orange	Blank	Press a key or move the mouse There may be a slight delay before the image reappears. Note: Standby also occurs if there is no image output to the monitor.
Off	Off	Blank	Press the power button There may be a slight delay before the image reappears.

Power Management Modes

VESA Modes	Horizontal Sync	Vertical Sync	Video	Power Indicator	Power Consumption
Normal operation	Active	Active	Active	White	85 W (maximum)* 54 W (typical)
Active-off mode	Inactive	Inactive	Off	Amber	Less than 0.5 W
Switch off	-	-	-	Off	Less than 0.3 W

*** Maximum power consumption with max luminance.**

This document is informational only and reflects laboratory performance. Your product may perform differently, depending on the software, components and peripherals you ordered and shall have no obligation to update such information. Accordingly, the customer should not rely upon this information in making decisions about electrical tolerances or otherwise. No warranty as to accuracy or completeness is expressed or implied.

Caring for your monitor

Be sure to turn off the power before you perform any maintenance on the monitor.

Do not:

- Apply water or liquid directly to your monitor.
- Use solvents or abrasives.
- Use flammable cleaning materials to clean your monitor or any other electrical equipment.
- Touch the screen area of your monitor with sharp or abrasive items. This type of contact may cause permanent damage to your screen.
- Use any cleaner which contains an anti-static solution or similar additives. This may harm the coating of the screen area.

Do:

- Lightly dampen a soft cloth with water and use this to gently wipe the covers and the screen.
- Remove grease or finger marks with a damp cloth and a little mild detergent.

Detaching the monitor base and stand

Step 1: Place the monitor on a soft and flat surface.

Step 2: Remove the screws from base before detaching base and stand from the monitor.



Wall Mounting (Optional)

Refer to the instructions that come with the base mounting kit. To convert your LCD display from a desk-mounted to a wall-mounted display, do the following:

Step 1: Verify that the Power button is turned Off, then disconnect the power cord.

Step 2: Lay the LCD display face down on a towel or blanket.

Step 3: Remove the base from the monitor, refer to “Detaching the monitor base and stand”.

Step 4: Attach the mounting bracket from the VESA compatible wall mounting kit (100 mm x 100 mm distance), VESA Mounting Screw M4 x 10 mm.

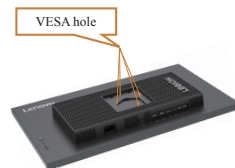

Step 5: Attach the LCD display to the wall, following the instructions in the wall-mounting kit.

For use only with UL Listed Wall Mount Bracket with minimum weight/load: 8kg

Note:

When you use a flexible arm, do not tilt the monitor downward by more than 5 degrees.

Chapter 3. Reference Information

This section contains monitor specifications, instructions to manually install the monitor driver, troubleshooting information.

Monitor specifications

Table 3-1. Monitor specifications for type-model F22270QY0

Dimensions	Depth	258.8 mm (10.19 inches)
	Height	536.5 mm (21.12 inches)
	Width	613.7 mm (24.16 inches)
Stand	Tilt	Range: -5°~25°
VESA mount	Supported	100 mm (3.94 in.)
Image	Viewable image size	685.7mm (27 inches)
	Maximum height	597.7mm (23.52 inches)
	Maximum width	335.7 mm (13.21 inches)
	Pixel pitch	0.2331 mm × 0.2331 mm (0.009 inches)
Power input	Rating	100-240 VAC 50~60 Hz 1.5 A
Power consumption Note: Power consumption figures are for the monitor and the power supply combined	Normal operation	<85 W (max) <54 W (Typical)
	Standby/Suspend	<0.5 W
	Off	<0.3 W
Video input (HDMI)	Input signal	HDMI
	Horizontal addressability	2560 pixels (maximum)
	Vertical addressability	1440 lines (maximum)
	Clock frequency	600 MHz
Video input (DP)	Input signal	DP
	Horizontal addressability	2560 pixels (maximum)
	Vertical addressability	1440 lines (maximum)
	Clock frequency	670 MHz

Table 3-1. Monitor specifications for type-mode F22270QY0

Communications	VESA DDC	CI
Supported Display Modes	Horizontal frequency	15-215(HDMI),15~256(DP) KHz
	Vertical frequency	48-144(HDMI),48~165(DP)Hz
	Native Resolution	2560 × 1440 @ 165 Hz(DP) 2560 × 1440 @ 165 Hz(HDMI)
Temperature	Operating	0° to 40°C (32° to 104°F)
	Storage	-20° to 60°C (-4° to 140°F)
	Shipping	-20° to 60°C (-4° to 140°F)
Humidity	Operating	8% to 80% non-condensing
	Storage	5% to 95% non-condensing
	Shipping	5% to 95% non-condensing

Troubleshooting

If you have a problem setting up or using your monitor, you might be able to solve it yourself. Before calling your dealer or Lenovo, try the suggested actions that are appropriate to your problem.

Table 3-2. Troubleshooting

Problem	Possible cause	Suggested action	Reference
The words “Out of Range” are shown on the screen, and the power indicator is flashing white.	The system is set to a display mode which is not supported by the monitor.	If you are replacing an old monitor, reconnect it and adjust the display mode to within the specified range for your new monitor. If using a Windows system, restart the system in safe mode, then select a supported display mode for your computer. If these options do not work, contact the Support Center.	“Selecting a supported display mode” on page 2-7
The image quality is unacceptable.	The video signal cable is not connected with the monitor or system completely.	Be sure the signal cable is firmly plugged into the system and monitor.	“Connecting and turning on your monitor” on page 1-5
	The color settings may be incorrect.	Select another color setting from the OSD menu.	“Adjusting your monitor image” on page 2-3
	The automatic image setup function was not performed.	Perform automatic image setup.	“Adjusting your monitor image” on page 2-3
The power indicator is not lit and there is no image.	<ul style="list-style-type: none"> • The monitor’s power switch is not switched on. • The power cord is loose or disconnected. • There is no power at the outlet. 	<ul style="list-style-type: none"> • Be sure the power cord is connected properly. • Be sure the outlet has power. • Power on the monitor. • Try using another power cord. • Try using another electrical outlet. 	“Connecting and turning on your monitor” on page 1-5
Screen is blank and power indicator is amber.	The monitor is in Standby/Suspend mode.	<ul style="list-style-type: none"> • Press any key on the keyboard or move the mouse to restore operation. • Check the Power Options settings on your computer. 	“Understanding power management” on page 2-8

Table 3-2. Troubleshooting

Problem	Possible cause	Suggested action	Reference
The power indicator is amber, but there is no image.	The video signal cable is loose or disconnected from the system or monitor.	Be sure the video cable is connected with the system properly.	“Connecting and turning on your monitor” on page 1-5
	The monitor brightness and contrast are at the lowest setting.	Adjust the brightness and contrast setting on the OSD menu.	“Adjusting your monitor image” on page 2-3
One or more of the pixels appear discolored.	This is a characteristic of the LCD technology and is not an LCD defect.	If there are more than five pixels missing, contact the Support Center.	“Appendix A. Service and Support” on page A-1
<ul style="list-style-type: none"> • Lines or images are blurred in the text. • There are horizontal or vertical lines in images. 	<ul style="list-style-type: none"> • Image setup has not been optimized. • The “Display Properties” settings of your system have not been optimized. 	According to the resolution of the monitor itself, adjust the resolution setting of the system: 2560 × 1440 @ 165 Hz(DP) 2560 × 1440 @ 144 Hz(HDMI).	“Adjusting your monitor image” on page 2-3
		Perform automatic image setup. If automatic image setup does not help, perform manual image setup.	“Selecting a supported display mode” on page 2-7
		When working in the native resolution, you may find additional improvements by adjusting the Dots Per Inch (DPI) setting on your system.	See the Advanced section of your system’s display properties.

Manually installing the monitor driver

Below are steps for manually installing the monitor driver in Microsoft Windows 7, Microsoft Windows 10, Microsoft Windows 11.

Installing the monitor driver in Windows 7

To use the Plug and Play feature in Microsoft Windows 7, do the following:

1. Turn off the computer and all attached devices.
2. Ensure that the monitor is connected correctly.
3. Turn on the monitor and then the system unit. Allow your computer to start the Windows 7 operating system.
4. From the Lenovo website https://pcsupport.lenovo.com/solutions/y27q_30, find the corresponding monitor driver and download it to a PC to which this monitor is connected (such as a desktop).
5. Open the Display Properties window by clicking Start, Control Panel and Hardware and Sound icon. and then clicking the Display icon.
6. Click the **Change the display settings** tab.
7. Click the **Advanced Settings** icon.
8. Click the **Monitor** tab.
9. Click the **Properties** button.
10. Click the **Driver** tab.
11. Click **Update Driver**, then click **Browse the computer to find the driver program**.
12. Select **Pick from the list of device driver program on the computer**.
13. Click the **Hard Disk** button. By clicking the **Browse** button and navigate to the directory that you put your download drivers in.
14. Select the “**Y27q-30.inf**” file and click the **Open** button. Click the **OK** button.
15. In the new window, select **Lenovo Y27q-30**, and click **Next**.
16. After the installation is completed, delete all downloaded files and close all windows.
17. Restart the system. The system will automatically select the maximum refresh rate and navigate to the following directory corresponding Color Matching Profiles.

Note: On LCD monitors, unlike CRTs, a faster refresh rate does not improve display quality. Lenovo recommends using either 2560 × 1440 at a refresh rate of 165 Hz, or 640 × 480 at a refresh rate of 60 Hz.

Installing the monitor driver in Windows 10

To use the Plug and Play feature in Microsoft Windows 10, do the following:

1. Turn off the computer and all attached devices.
2. Ensure that the monitor is connected correctly.
3. Turn on the monitor and then the system unit. Allow your computer to start the Windows 10 operating system.
4. From the Lenovo website https://pcsupport.lenovo.com/solutions/y27q_30, find the corresponding monitor driver and download it to a PC to which this monitor is connected (such as a desktop).
5. On the Desktop, move the mouse to the bottom-right corner of the screen, choose **Setting**, double click **Control Panel**, then double click the icon of **Hardware and Sound**, and then click **Device Manager**.
6. Click the **Monitor** tab.
7. Click the **Properties** button.
8. Click the **Driver** tab.
9. Click **Update Driver**, then click **Browse the computer to find the driver program**.
10. Select **Pick from the list of device driver program on the computer**.
11. Click the **Hard Disk** button. By clicking the **Browse** button and navigate to the directory that you put your download drivers in.
12. Select the “**Y27q-30.inf**” file and click the **Open** button. Click the **OK** button.
13. In the new window, select **Lenovo Y27q-30**, and click **Next**.
14. After the installation is completed, delete all downloaded files and close all windows.
15. Restart the system. The system will automatically select the maximum refresh rate and navigate to the following directory corresponding Color Matching Profiles.

Note: On LCD monitors, unlike CRTs, a faster refresh rate does not improve display quality. Lenovo recommends using either 2560 × 1440 at a refresh rate of 165 Hz, or 640 × 480 at a refresh rate of 60 Hz.

Installing the monitor driver in Windows 11

To use the Plug and Play feature in Microsoft Windows 11, do the following:

1. Turn off the computer and all attached devices.
2. Ensure that the monitor is connected correctly.
3. Turn on the monitor and then the system unit. Allow your computer to start the Windows 11 operating system.
4. From the Lenovo website https://pcsupport.lenovo.com/solutions/y27q_30, find the corresponding monitor driver and download it to a PC to which this monitor is connected (such as a desktop).
5. On the Desktop, move the mouse to the bottom-right corner of the screen, choose **Setting**, double click **Control Panel**, then double click the icon of **Hardware and Sound**, and then click **Device Manager**.
6. Click the **Monitor** tab.
7. Click the **Properties** button.
8. Click the **Driver** tab.
9. Click **Update Driver**, then click **Browse the computer to find the driver program**.
10. Select **Pick from the list of device driver program on the computer**.
11. Click the **Hard Disk** button. By clicking the **Browse** button and navigate to the directory that you put your download drivers in.
12. Select the “**Y27q-30.inf**” file and click the **Open** button. Click the **OK** button.
13. In the new window, select **Lenovo Y27q-30**, and click **Next**.
14. After the installation is completed, delete all downloaded files and close all windows.
15. Restart the system. The system will automatically select the maximum refresh rate and navigate to the following directory corresponding Color Matching Profiles.

Note: On LCD monitors, unlike CRTs, a faster refresh rate does not improve display quality. Lenovo recommends using either 2560 × 1440 at a refresh rate of 165 Hz, or 640 × 480 at a refresh rate of 60 Hz.

Getting further help

If you still can't solve your problem, please contact the Lenovo Support Center. For more information on contacting the Support Center, please see “Appendix A. Service and Support” on page A-1

Service information

Customer responsibilities

The warranty does not apply to a product which has been damaged due to accident, misuse, abuse, improper installation, usage not in accordance with product specifications and instructions, natural or personal disaster, or unauthorized alterations, repairs or modifications.

The following are examples of misuse or abuse and not covered by warranty:

- Images burned onto the screen of a CRT monitor. Burned image is preventable by utilizing a moving screen saver or power management.
- Physical damage to covers, bezel, base and cables.
- Scratches or punctures on monitor screens.

Appendix A. Service and Support

The following information describes the technical support that is available for your product, during the warranty period or throughout the life of your product. Refer to the Lenovo Limited Warranty for a full explanation of Lenovo warranty terms.

Registering your option

Register to receive product service and support updates, as well as free and discounted computer accessories and content. Go to:
<http://www.lenovo.com/register>

Online technical support

Online technical support is available during the lifetime of a product at:
<http://www.lenovo.com/support>

Product replacement assistance or exchange of defective components also is available during the warranty period. In addition, if your option is installed in a Lenovo computer, you might be entitled to service at your location. A Lenovo technical support representative can help you determine the best alternative.

Telephone technical support

Installation and configuration support through the Customer Support Center will be available until 90 days after the option has been withdrawn from marketing. After that time, the support is cancelled, or made available for a fee, at Lenovo's discretion. Additional support is also available for a nominal fee.

Before contacting a Lenovo technical support representative, please have the following information available: option name and number, proof of purchase, computer manufacturer, model, serial number and manual, the exact wording of any error message, description of the problem, and the hardware and software configuration information for your system.

Your technical support representative might want to walk you through the problem while you are at your computer during the call.

Telephone numbers are subject to change without notice. The most up-to-date telephone list for Lenovo Support is always available at: <http://www.lenovo.com/support/phone>

Country or Region	Telephone Number
China	400-990-8888
South Africa	800982393
Argentina	0800-444-24.522(Spanish)
Australia	1300-557-073
Austria	800295730(German)
Belgium	80076524(French, Dutch)
Bolivia	800-100-764(Spanish)

Appendix B. Notices

Lenovo may not offer the products, services, or features discussed in this document in all countries. Consult your local Lenovo representative for information on the products and services currently available in your area. Any reference to a Lenovo product, program, or service is not intended to state or imply that only that Lenovo product, program, or service may be used. Any functionally equivalent product, program, or service that does not infringe any Lenovo intellectual property right may be used instead.

However, it is the user's responsibility to evaluate and verify the operation of any other product, program, or service.

Lenovo may have patents or pending patent applications covering subject matter described in this document. The furnishing of this document does not give you any license to these patents. You can send license inquiries, in writing, to:

*Lenovo (United States), Inc.
1009 Think Place - Building One
Morrisville, NC 27560
U.S.A.
Attention: Lenovo Director of Licensing*

LENOVO PROVIDES THIS PUBLICATION "AS IS" WITHOUT WARRANTY OF ANY KIND, EITHER EXPRESS OR IMPLIED, INCLUDING, BUT NOT LIMITED TO, THE IMPLIED WARRANTIES OF NON-INFRINGEMENT, MERCHANTABILITY OR FITNESS FOR A PARTICULAR PURPOSE. Some jurisdictions do not allow disclaimer of express or implied warranties in certain transactions, therefore, this statement may not apply to you.

This information could include technical inaccuracies or typographical errors. Changes are periodically made to the information herein; these changes will be incorporated in new editions of the publication. Lenovo may make improvements and/or changes in the product(s) and/or the program(s) described in this publication at any time without notice.

The products described in this document are not intended for use in implantation or other life support applications where malfunction may result in injury or death to persons. The information contained in this document does not affect or change Lenovo product specifications or warranties. Nothing in this document shall operate as an express or implied license or indemnity under the intellectual property rights of Lenovo or third parties. All information contained in this document was obtained in specific environments and is presented as an illustration. The result obtained in other operating environments may vary.

Lenovo may use or distribute any of the information you supply in any way it believes appropriate without incurring any obligation to you.

Any references in this publication to non-Lenovo Web sites are provided for convenience only and do not in any manner serve as an endorsement of those Web sites. The materials at those Web sites are not part of the materials for this Lenovo product, and use of those Web sites is at your own risk.

Any performance data contained herein was determined in a controlled environment. Therefore, the result obtained in other operating environments may vary significantly. Some measurements may have been made on development-level systems and there is no guarantee that these measurements will be the same on generally available systems. Furthermore, some measurements may have been estimated through extrapolation. Actual results may vary. Users of this document should verify the applicable data for their specific environment.

Recycling information

Lenovo encourages owners of information technology (IT) equipment to responsibly recycle their equipment when it is no longer needed. Lenovo offers a variety of programs and services to assist equipment owners in recycling their IT products. For information on recycling Lenovo products, go to:

<http://www.lenovo.com/lenovo/recycling>

環境配慮に関して

本機器またはモニターの回収リサイクルについて

企業のお客様が、本機器が使用済みとなり廃棄される場合は、資源有効利用促進法の規定により、産業廃棄物として、地域を管轄する県知事あるいは、政令市長の許可を持った産業廃棄物処理業者に適正処理を委託する必要があります。また、弊社では資源有効利用促進法に基づき使用済みパソコンの回収および再利用・再資源化を行う「PC回収リサイクル・サービス」を提供しています。詳細は、https://www.lenovo.com/jp/ja/services_warranty/recycle/personal/をご参照ください。

また、同法により、家庭で使用済みとなったパソコンのメーカー等による回収再資源化が2003年10月1日よりスタートしました。詳細は、https://www.lenovo.com/jp/ja/services_warranty/recycle/personal/をご参照ください。

重金属を含む内部部品の廃棄処理について

本機器のプリント基板等には微量の重金属（鉛など）が使用されています。使用後は適切な処理を行うため、上記「本機器またはモニターの回収リサイクルについて」に従って廃棄してください。

Collecting and recycling a disused Lenovo computer or monitor

If you are a company employee and need to dispose of a Lenovo computer or monitor that is the property of the company, you must do so in accordance with the Law for Promotion of Effective Utilization of Resources. Computers and monitors are categorized as industrial waste and should be properly disposed of by an industrial waste disposal contractor certified by a local government. In accordance with the Law for Promotion of Effective Utilization of Resources, Lenovo Japan provides, through its PC Collecting and Recycling Services, for the collecting, reuse, and recycling of disused computers and monitors. For details, visit the Lenovo Web site at https://www.lenovo.com/jp/ja/services_warranty/recycle/personal/. Pursuant to the Law for Promotion of Effective Utilization of Resources, the collecting and recycling of home-used computers and monitors by the manufacturer was begun on October 1, 2003. This service is provided free of charge for home-used computers sold after October 1, 2003. For details, visit the Lenovo Web site at https://www.lenovo.com/jp/ja/services_warranty/recycle/personal/

Disposing of Lenovo computer components

Some Lenovo computer products sold in Japan may have components that contain heavy metals or other environmental sensitive substances. To properly dispose of disused components, such as a printed circuit board or drive, use the methods described above for collecting and recycling a disused computer or monitor.

Trademarks

The following terms are trademarks of Lenovo in the United States, other countries, or both:

Lenovo
The Lenovo logo
ThinkCenter
ThinkPad
ThinkVision

Microsoft, Windows, and Windows NT are trademarks of the Microsoft group of companies. Other company, product, or service names may be trademarks or service marks of others.

Power cords and power adapters

Use only the power cords and power adapters supplied by the product manufacturer.
Do not use the ac power cord for other devices.