



**LBP246dw / LBP243dw**

# **User's Guide**

# Contents

<b>About the Machine</b> .....	2
<b>Supported Functions and Options</b> .....	3
Cassette Feeding Module-AH .....	5
<b>System Manager ID and PIN</b> .....	6
<b>Measures to Prevent Unauthorized Access</b> .....	7
<b>Names of Parts and Their Functions</b> .....	9
Front Side .....	10
Rear Side .....	12
Interior .....	13
Control Panel .....	14
Multi-purpose Tray .....	16
Paper Drawer .....	17
<b>Usable Paper</b> .....	18
Precautions When Handling Paper .....	22
<b>Specifications</b> .....	23
Basic Specifications .....	24
Print Specifications .....	26
Network Specifications .....	28
Security and Management Function Specifications .....	29
Supported Environment .....	34
<b>Recommended Functions</b> .....	35
Cost Savings .....	36
Making Operations More Efficient .....	37
<b>Setting Up</b> .....	39
<b>Configuring the Default Settings (Setup Guide)</b> .....	40
<b>Setting Up the Network</b> .....	43
Selecting Wired or Wireless LAN .....	45
Connecting to a Wired LAN .....	46
Connecting to a Wireless LAN .....	47
Connecting to a Wireless LAN by Using the Router Button (Push Button Mode) .....	50
Connecting to a Wireless LAN by Entering a PIN Code (WPS PIN Code Mode) .....	51
Connecting to a Wireless LAN by Searching for a Router (Access Point Setup Method) .....	53
Connecting to a Wireless LAN by Setting the Details (Manual Setup Method) .....	55
Setting IPv4 Addresses .....	58
Setting IPv6 Addresses .....	60
Configuring Your Machine for Your Network Environment .....	62
Manually Configuring the Ethernet Settings .....	63
Configuring DNS .....	64
Configuring SMB .....	67
Configuring WINS .....	68
Configuring SNMP .....	69

Configuring SNTP .....	72
Configuring SLP Communication .....	74
Checking the Network Status and Settings .....	76
<b>Installing Software and Drivers to the Computer .....</b>	<b>79</b>

## **Basic Operations ..... 81**

<b>Turning ON and OFF the Machine .....</b>	<b>82</b>
Turning ON the Machine .....	83
Turning OFF the Machine .....	84
Restarting the Machine .....	87
<b>Reducing Power Consumption (Sleep Mode) .....</b>	<b>89</b>
<b>Using the Control Panel .....</b>	<b>91</b>
Screens Displayed on the Control Panel .....	92
[Home] Screen .....	94
[Status Monitor] Screen .....	95
How to Operate the Control Panel .....	97
Entering Characters .....	99
Customizing the [Home] Screen .....	102
<b>Logging In to the Machine .....</b>	<b>103</b>
<b>Loading Paper .....</b>	<b>104</b>
Loading Paper in the Paper Drawer .....	105
Loading Paper in the Multi-purpose Tray .....	110
Preparations and Orientation for Loading Envelopes .....	113
Orientation for Loading Paper with a Logo .....	115
Specifying the Paper Size and Type .....	119
Setting the Paper Size and Type for the Paper Drawer .....	120
Setting the Paper Size and Type for the Multi-purpose Tray .....	122
Registering a Frequently Used Paper Size and Type for the Multi-purpose Tray .....	124
Registering Non-standard Size Paper (Custom Paper) .....	126
Hiding Unused Paper Sizes .....	127
Using the Appropriate Paper Source for Each Function .....	128
<b>Inserting and Removing a USB Memory Device .....</b>	<b>129</b>
<b>Adjusting the Sound Volume .....</b>	<b>131</b>
Adjusting the Volume .....	132
[Volume Settings] Screen .....	133

## **Printing ..... 135**

<b>Printing Preparations .....</b>	<b>137</b>
Preparing to Print from a Computer .....	138
Configuring a Printer Port (Windows) .....	141
Setting Up a Print Server .....	144
Preparations for Using Universal Print .....	147
Registering the Machine to Cloud Service .....	148
Registering the Machine to the Computer .....	151
Preparing to Receive and Print I-Faxes .....	152

<b>Printing from a Computer</b> .....	154
Registering Non-standard Size Paper to the Computer (Custom Size) .....	157
Printing a Document Secured with a PIN (Secure Print) .....	159
Changing the Time Period That Print Data with a PIN (Secure Data) Is Saved .....	162
Enabling Secure Print in a Printer Driver (macOS) .....	163
Printing with Universal Print .....	164
<b>Receiving and Printing I-Faxes</b> .....	165
Changing the Print Settings of the Received I-Fax .....	166
<b>Canceling Printing</b> .....	167
<b>Viewing the Print Job Status and Log</b> .....	169

## Linking with Mobile Devices ..... 171

<b>Preparations for Linking with Mobile Devices</b> .....	172
Preparations for Direct Connection .....	173
Preparations for Using AirPrint .....	175
<b>Connecting a Mobile Device to the Machine</b> .....	178
Connecting a Mobile Device via Wireless LAN Router (LAN Connection) .....	179
Connecting a Mobile Device Directly to the Machine (Direct Connection) .....	180
<b>Using a Dedicated Application to Print (Canon PRINT Business)</b> .....	182
<b>Using AirPrint Application to Print Data</b> .....	183
<b>Printing from an Android Device</b> .....	186
<b>Printing from Chromebook or Other Device with Chrome OS</b> .....	188

## Security ..... 190

<b>Setting the Department ID and PIN for the Administrator</b> .....	191
<b>Authenticating Users and Managing Groups</b> .....	193
Authenticating Users and Managing Groups with Department ID (Department ID Management) .....	194
Registering a Department ID and PIN .....	196
Enabling Department ID Management .....	198
Setting the Department ID and PIN on a Computer .....	199
Confirming Usage by Department ID .....	201
<b>Protecting the Network</b> .....	202
Setting the Firewall .....	203
Changing the Port Number .....	206
Using a Proxy .....	207
Using TLS .....	209
Using IPsec .....	211
Using IEEE 802.1X .....	215
Managing and Verifying a Key and Certificate .....	217
Generating a Key and Certificate .....	218
Generating a Key and Certificate Signing Request (CSR) and Obtaining and Registering a Certificate .....	220
Generating a Key and Obtaining and Registering a Certificate from an SCEP Server .....	223
If an Error Is Displayed in the Certificate Issuance Request Status .....	228
Registering a Key and Certificate or CA Certificate Obtained from an Issuing Authority .....	230
Verifying a Received Certificate with OCSP .....	232

<b>Preventing Leaking Information</b> .....	233
Restricting Use of Memory Media .....	234
Restricting Use from a Mobile Device .....	235
Restricting Printing .....	236
Restricting Printing from a Computer to Secure Print .....	237
<b>Preventing Unauthorized Use</b> .....	238
Restricting Use of Remote UI .....	239
Preventing Connection to Computer via USB Port .....	241
Configuring LPD, RAW, or WSD .....	242
Disabling HTTP Communication .....	244
Restricting Use of the Control Panel .....	245
<b>Applying a Security Policy</b> .....	246
Security Policy Items .....	248

## **Managing the Machine** ..... 253

<b>Setting the Date and Time</b> .....	254
<b>Managing the Machine from a Computer (Remote UI)</b> .....	255
Starting Remote UI .....	256
Portal Page of Remote UI .....	259
Checking Usage and Logs with Remote UI .....	261
<b>Monitoring the Usage</b> .....	263
Checking the Number of Printed Pages (Check Counter) .....	264
Printing and Viewing Reports and Lists .....	265
Changing the Report and List Print Settings .....	267
<b>Importing and Exporting the Settings</b> .....	268
<b>Updating the Firmware</b> .....	270
<b>Initializing the Settings and Data</b> .....	273

## **Settings Menu Items** ..... 277

<b>[Preferences]</b> .....	278
[Display Settings] .....	280
[Timer/Energy Settings] .....	284
[Network] .....	288
[Wireless LAN Settings] .....	293
[TCP/IP Settings] .....	295
[External Interface] .....	302
[Accessibility] .....	303
[Volume Settings] .....	305
<b>[Adjustment/Maintenance]</b> .....	307
[Adjust Image Quality] .....	308
[Special Processing] .....	310
[Maintenance] .....	315
<b>[Function Settings]</b> .....	316
[Common] .....	318

[Paper Feed Settings] .....	319
[Print Settings] .....	321
[Printer] .....	322
[Printer Settings] .....	323
[PDL Selection (Plug and Play)] .....	339
[Receive] .....	340
[Common Settings] .....	341
[E-Mail Settings] .....	342
<b>[Management Settings]</b> .....	343
[User Management] .....	345
[Device Management] .....	346
[Remote UI Settings/Update Firmware] .....	349
[Remote UI Settings] .....	350
[Data Management] .....	351
[Security Settings] .....	353
[Authentication/Password Settings] .....	354
<b>Settings that Can Be Imported and Exported</b> .....	355
[Preferences] .....	356
[Adjustment/Maintenance] .....	360
[Function Settings] .....	361
[Management Settings] .....	363

## **Maintenance** ..... 366

<b>Cleaning the Machine</b> .....	368
Cleaning the Surface of the Machine .....	369
Cleaning the Fixing Assembly .....	370
<b>Replacing Consumables</b> .....	371
Replacing the Toner Cartridge .....	372
Checking the Remaining Amount of Consumables .....	377
List of Consumables .....	378
<b>Adjusting the Print Quality and Position</b> .....	380
Adjusting the Print Density .....	381
Adjusting the Print Position .....	382
<b>Moving the Machine</b> .....	384

## **Troubleshooting** ..... 388

<b>Paper Jams</b> .....	389
Paper Jams Inside the Machine .....	390
Paper Jams in a Paper Source .....	395
Paper Jams That Occur Repeatedly .....	397
<b>Problems with Printing Results</b> .....	399
Toner Smudges and Splatters Appear .....	401
Streaks Appear .....	402
Printing Is Uneven .....	404
Printed Paper Is Blank .....	405

Smudge Marks Appear on the Edge of Printouts .....	406
Text or Images Are Blurry .....	407
Printouts Have Ghost Images .....	408
Printouts Are Faded .....	409
The Edge of the Page Is Not Printed .....	411
The Background Is Generally Dark .....	412
White Spots Appear .....	413
Smudge Marks Appear on the Back Side of Printouts .....	415
Printouts Are Skewed .....	416
The Printed Barcode Cannot be Scanned .....	417
<b>Paper and Paper Feeding Problems</b> .....	418
Paper Creases .....	419
Paper Curls .....	420
Paper Is Not Fed or Two or More Sheets Are Fed Together .....	421
<b>Setting Up</b> .....	422
The Machine Connected via WSD Port Is Not Displayed During Driver Installation .....	423
Cannot Connect to Wireless LAN .....	424
<b>Network</b> .....	425
Cannot Switch to Wireless LAN .....	426
Cannot Find the Print Server to Connect to .....	427
Cannot Connect to a Shared Printer .....	428
Cannot Find the IP Address of the Machine .....	429
AirPrint Does Not Work .....	430
<b>Printing</b> .....	431
Cannot Print .....	432
Cannot Print (Wireless LAN) .....	433
Cannot Print (Wired LAN) .....	435
Cannot Print (USB Connection) .....	436
Cannot Print (via Print Server) .....	437
Printing Is Slow .....	438
<b>Management Functions and Environment Settings</b> .....	439
Cannot Access Remote UI .....	440
Changing the Volume of the Confirmation Sound and Warning Tone .....	441
Changing the Time Until Sleep Mode .....	442
Lost Department ID or PIN for the Administrator .....	443
Checking the Items That Can Be Configured on the Machine and Their Settings .....	444
<b>A Message Appears</b> .....	445
<b>An Error Code Is Displayed</b> .....	458
<b>If the Problem Persists</b> .....	463

<b>Appendix</b> .....	465
<b>Manuals of the Machine</b> .....	466
<b>Using the User's Guide</b> .....	467
<b>Manual Display Settings</b> .....	469

<b>Operation Examples When Using a Computer .....</b>	<b>470</b>
<b>Environmental Information, Regulations, and Standards .....</b>	<b>480</b>
<b>Notice .....</b>	<b>482</b>
<b>Trademarks and Copyrights .....</b>	<b>483</b>
<b>Third-party Software .....</b>	<b>485</b>



# About the Machine

- About the Machine** ..... 2
- Supported Functions and Options** ..... 3
  - Cassette Feeding Module-AH ..... 5
- System Manager ID and PIN** ..... 6
- Measures to Prevent Unauthorized Access** ..... 7
- Names of Parts and Their Functions** ..... 9
  - Front Side ..... 10
  - Rear Side ..... 12
  - Interior ..... 13
  - Control Panel ..... 14
  - Multi-purpose Tray ..... 16
  - Paper Drawer ..... 17
- Usable Paper** ..... 18
  - Precautions When Handling Paper ..... 22
- Specifications** ..... 23
  - Basic Specifications ..... 24
  - Print Specifications ..... 26
  - Network Specifications ..... 28
  - Security and Management Function Specifications ..... 29
  - Supported Environment ..... 34
- Recommended Functions** ..... 35
  - Cost Savings ..... 36
  - Making Operations More Efficient ..... 37

# About the Machine

---

9664-000

Before using the machine, check the basic information of the machine such as the supported functions and options, names of each part, and specifications of the functions. Also consider the management system of the machine and measures against security risks.

## Basic Information

The supported functions and options vary depending on the model. Check the list for details. You can also check the specifications of the options.

### ▶Supported Functions and Options(P. 3)

Check the names of parts, usable paper, and specifications of functions, as needed.

### ▶Names of Parts and Their Functions(P. 9)

### ▶Usable Paper(P. 18)

### ▶Specifications(P. 23)

## Information Required for Management Functions

When using the management functions, use the System Manager ID and PIN to log in.

### ▶System Manager ID and PIN(P. 6)

When using the machine in a network environment, check the examples of measures to prevent unauthorized access, and consider implementing these.

### ▶Measures to Prevent Unauthorized Access(P. 7)

## Useful Tips

Introduces recommended functions useful for digitizing documents, reducing costs, and making operations more efficient.

### ▶Recommended Functions(P. 35)

## Supported Functions and Options

9664-001

User's Guide (this manual) describes all functions of the model series including the machine.

Some of the functions listed in User's Guide may not be available depending on your model. Use the table below to see which functions and options are supported by your model.

🔴 **Supported Functions**(P. 3)

🔴 **Supported Options**(P. 4)

### Supported Functions

✓ : Supported    — : Not supported

Function	LBP246dw	LBP243dw
Print	✓	✓
2-sided Printing	✓	✓
Secure Print	✓	—
Wired LAN connection	✓	✓
Wireless LAN connection	✓	✓
USB connection	✓	✓
Remote UI	✓	✓
Keys and certificates	✓	✓
Linking with mobile devices	✓	✓
Display	Black and white LCD	Black and white LCD
Default System Manager ID	Not specified	Not specified
Default System Manager PIN	Not specified	Not specified
Department ID Management	✓	✓

### NOTE

- For details about the types of available drivers, see the Canon website for your country or region, or see the supplied User Software CD-ROM/DVD-ROM.

<https://global.canon/en/support/>

## Supported Options

You can use the option to suit your purpose.

- Adding a paper drawer ▶ **Cassette Feeding Module-AH(P. 5)**

✓ : Supported    — : Not supported

Option	LBP246dw	LBP243dw
Cassette Feeding Module-AH	✓	✓

## Cassette Feeding Module-AH

9664-002

When frequently using paper of varying sizes or types or when loading large quantities of paper at a time, install the optional Cassette Feeding Module-AH. This option reduces the work of loading paper. For how to install Cassette Feeding Module-AH, see "Setup Guide." [▶ Manuals of the Machine\(P. 466\)](#)

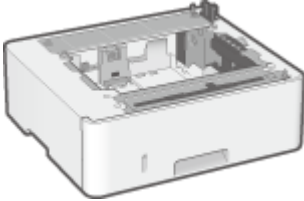

### ■ Specifications

<b>Paper size</b>	Maximum: 216.0 mm x 355.6 mm Minimum: 105.0 mm x 148.0 mm
<b>Paper basis weight</b>	60 g/m <sup>2</sup> to 120 g/m <sup>2</sup>
<b>Number of paper sources and paper capacity</b> *1	Paper drawer x 1 550 sheets (80 g/m <sup>2</sup> ), 640 sheets (64 g/m <sup>2</sup> )
<b>Dimensions</b> (W x D x H)	399 mm x 356 mm x 131 mm
<b>Weight</b>	Approx. 3.8 kg

\*1 Varies depending on the installation environment and paper to be used.

## System Manager ID and PIN

---

9664-003

The machine has a System Manager Mode for viewing and changing important settings. When System Manager ID and System Manager PIN are set, only those users who know this information are able to log into System Manager Mode.

The System Manager ID and System Manager PIN are not set. System Manager Mode is disabled, allowing anyone to see and change important settings. Set the System Manager ID and System Manager PIN to protect the information, and allow only certain administrators of this information.

For details about how to change and set the System Manager ID and System Manager PIN, see the following:

➤ **Setting the Department ID and PIN for the Administrator(P. 191)**

# Measures to Prevent Unauthorized Access

9664-004

Be sure to read this section before using the machine in a network environment.

Printers and multifunction machines can provide various useful functions when connected to a network. However, because this also creates risks of unauthorized access and eavesdropping over the network, measures against security risks are essential.

This section provides examples of measures against unauthorized access that you can implement during setup when using the machine in a network environment.

- ▶ **Using a Private IP Address(P. 7)**
- ▶ **Using a PIN to Protect Information(P. 7)**
- ▶ **Precautions When Using Remote UI(P. 8)**

## NOTE

- There are additional measures against security risks you can implement on the machine, such as restricting communication with a firewall and using TLS encrypted communication to prevent eavesdropping and tampering. Take the necessary measures according to your usage environment. ▶ **Security(P. 190)**

## Using a Private IP Address

There are two types of IP addresses: a global IP address, which is used for connecting to the Internet, and a private IP address, which is used in a local area network such as a company LAN.

If a global IP address is assigned to the machine, the machine can be accessed by users on the Internet. Thus, the risk of information leakage due to unauthorized access from external network increases.

On the other hand, if a private IP address is assigned to the machine, access to the machine is restricted to only users on your local area network. Therefore, it reduces the risk of unauthorized access compared to an assigned global IP address.

Basically, assign a private IP address to the machine.

A private IP address is used in one of the following ranges.

### Ranges for Private IP Addresses

- From 10.0.0.0 to 10.255.255.255
- From 172.16.0.0 to 172.31.255.255
- From 192.168.0.0 to 192.168.255.255

For details about how to assign and confirm the IP address, see the following:

- ▶ **Setting IPv4 Addresses(P. 58)**
- ▶ **Setting IPv6 Addresses(P. 60)**

If you want to assign a global IP address to the machine, you can create an environment to prevent outside access, such as by using a firewall, to reduce the risk of unauthorized access. Contact your network administrator about how to implement network security.

## Using a PIN to Protect Information

By setting up a PIN to protect the information stored in the machine, you can reduce the risk of information leakage or unauthorized use if a malicious third party attempts to gain unauthorized access.

You can set a PIN to the functions indicated below. Only users who know the PIN can use these functions and access the information on the machine.

### Remote UI

You can require the user to enter the Remote UI Access PIN when using Remote UI.

▶ **Setting the PIN to Use for Remote UI(P. 239)**

### **System Manager ID**

You can require the user to enter the System Manager ID and System Manager PIN, when changing any important settings.

▶ **Setting the Department ID and PIN for the Administrator(P. 191)**

## Precautions When Using Remote UI

- Do not access other websites when using Remote UI.
- After using Remote UI, be sure to log out and close your browser.



## Names of Parts and Their Functions

---

9664-005

### Front Side

Check these parts on the front when operating the machine.

#### ▶ Front Side(P. 10)

- Use the control panel to operate the machine and configure the settings.

#### ▶ Control Panel(P. 14)

- Load printing paper into the following paper sources:

#### ▶ Multi-purpose Tray(P. 16)

#### ▶ Paper Drawer(P. 17)

### Rear Side

Check the rear parts when installing and connecting the machine and when clearing paper jams.

#### ▶ Rear Side(P. 12)

### Interior

Check the interior of the machine when clearing paper jams.

#### ▶ Interior(P. 13)

## Front Side

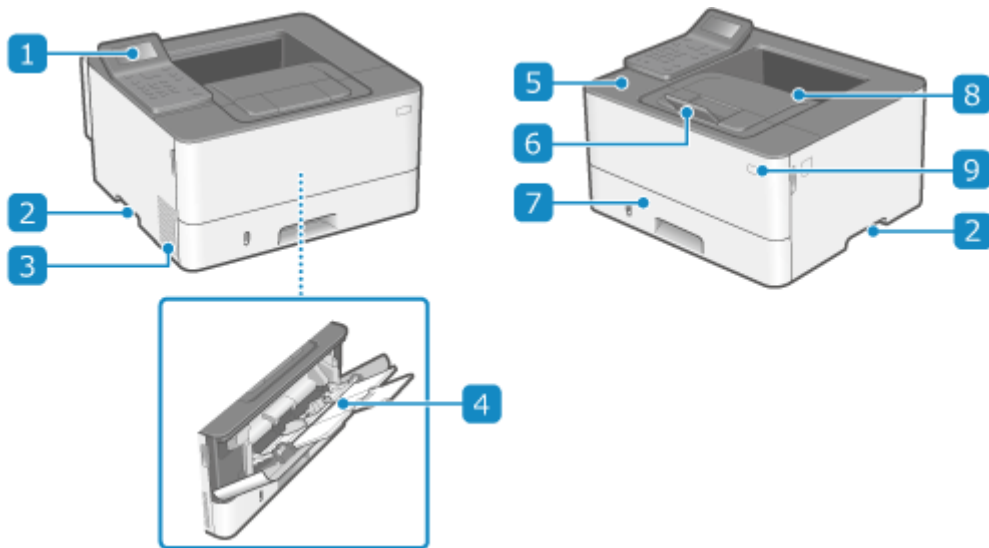

### 1 Control panel

Use the display and keys to operate the machine and confirm the operations and status. ▶ **Control Panel(P. 14)**

### 2 Lift handles

Hold the lift handles when moving the machine.

### 3 Ventilation slots

Air inside the machine is released through the ventilation slots to cool down the inside of the machine. Do not place objects next to the ventilation slots, as this can prevent ventilation.

### 4 Multi-purpose tray

To temporarily use paper not loaded in the paper drawer, load it in the multi-purpose tray. ▶ **Multi-purpose Tray(P. 16)**

### 5 Front cover

Open when replacing toner cartridge or when a paper jam occurs inside the machine.

### 6 Paper stopper

Open the paper stopper to prevent paper from falling out of the output tray.

### 7 Paper drawer

Load paper you usually use into the paper drawer. ▶ **Paper Drawer(P. 17)**

### 8 Output tray

Printed paper is ejected to the output tray.

## **9 Power switch**

Turns the power of the machine ON and OFF. ▶ **Turning ON and OFF the Machine(P. 82)**

### **NOTE**

- To ensure efficient use of the machine, regularly clean the surface.  
▶ **Cleaning the Surface of the Machine(P. 369)**

## Rear Side

9664-007

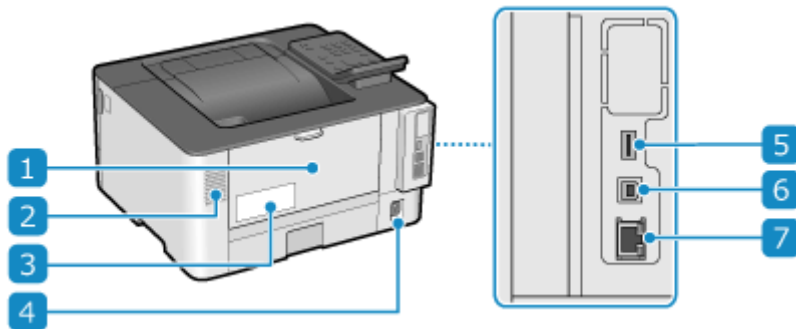

### 1 Rear cover

Open the rear cover when a paper jam occurs inside the machine.

### 2 Ventilation slots

Air inside the machine is released through the ventilation slots to cool down the inside of the machine. Do not place objects next to the ventilation slots, as this can prevent ventilation.

### 3 Rating label

This label shows the serial number, which is needed when making inquiries about the machine.

### 4 Power socket

Connect the power cord to the power socket.

### 5 USB port (for USB devices)

You can connect a commercial USB memory device or USB keyboard.

### 6 USB port (for computer connection)

You can connect a computer to the USB port using a commercial USB cable.

### 7 LAN port

You can connect the machine to a wired LAN using a commercial Ethernet cable connected to the LAN port.

## Interior

9664-008

Check the interior of the machine when clearing paper jams. ▶ **Paper Jams(P. 389)**

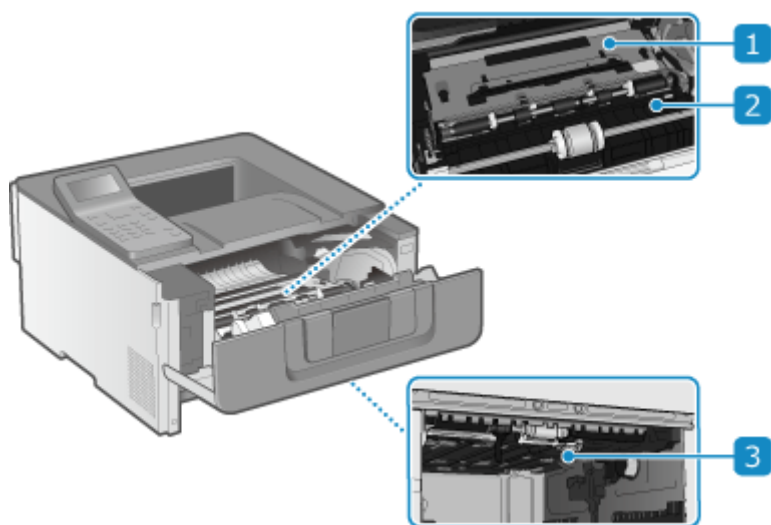

### 1 Transport guide (rear)

If a paper jam occurs inside the machine, lift the front of the transport guide and remove the paper.

### 2 Transport guide (front)

If a paper jam occurs inside the machine, lift the rear of the transport guide and remove the paper.

### 3 2-sided transport guide

If a paper jam occurs during 2-sided printing, push this guide down and remove the paper.

# Control Panel

Use the control panel to operate the machine and configure the settings.

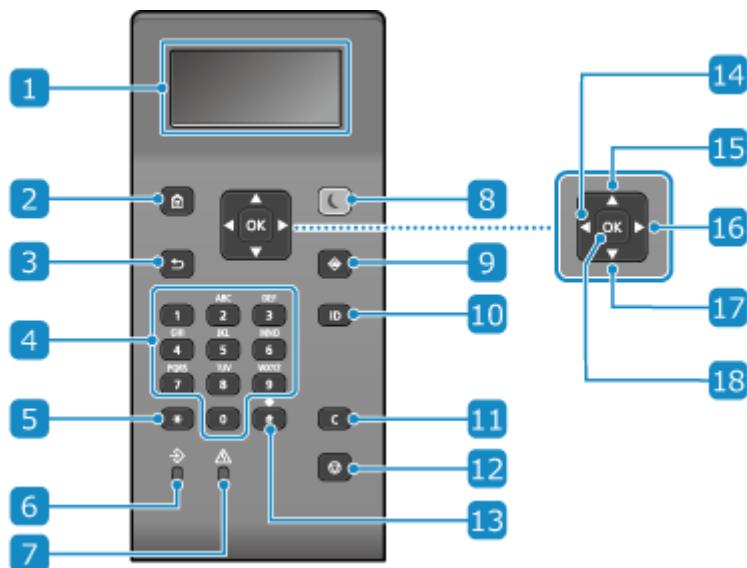

## 1 Display

Displays the screens for operating the functions, usage, messages, and other information. **▶Using the Control Panel(P. 91)**

## 2 Home key ( )

Displays the [Home] screen. **▶[Home] Screen(P. 94)**

## 3 Back key ( )

Returns you to the previous screen.

## 4 Numeric keys ( to )

Enter numbers or characters. **▶Entering Characters(P. 99)**

## 5 Uppercase/lowercase/numeric key ( )

Changes the character type.

## 6 Data indicator

Blinks when an operation is being performed, such as during printing, and lights up when data is waiting to be processed.

## 7 Error indicator

Blinks or lights up when a paper jam or other error occurs.

**8 Energy Saver key (  )**

Puts the machine into sleep mode to reduce power consumption. In sleep mode,  lights up yellow-green.

▶ **Reducing Power Consumption (Sleep Mode)(P. 89)**

**9 Status Monitor key (  )**

Check the information of the machine, usage and logs, network settings, and error information. ▶ **[Status Monitor] Screen(P. 95)**

**10 ID key (  )**

Press after entering the ID and PIN to log in when Department ID Management and the System Manager ID is enabled. After you finish using the machine, press this key again to log out. ▶ **Logging In to the Machine(P. 103)**

**11 Clear key (  )**

Deletes the entered numbers and text.

**12 Stop key (  )**

Cancels printing and other operations.

**13 Symbol key (  )**

Enter symbols. ▶ **Entering Characters(P. 99)**

**14 Left key (  )**

Returns to the previous screen. Press when entering text to move the cursor to the left.

**15 Up key (  )**

Selects the item above and increases the value on a slider.

**16 Right key (  )**

Moves to the next screen. Press when entering text to move the cursor to the right.

**17 Down key (  )**

Selects the item below and decreases the value on a slider.

**18 OK key (  )**

Confirms the settings and selected details.

## Multi-purpose Tray

9664-00A

Load paper that you will temporarily use in the multi-purpose tray. **▶Loading Paper in the Multi-purpose Tray(P. 110)**

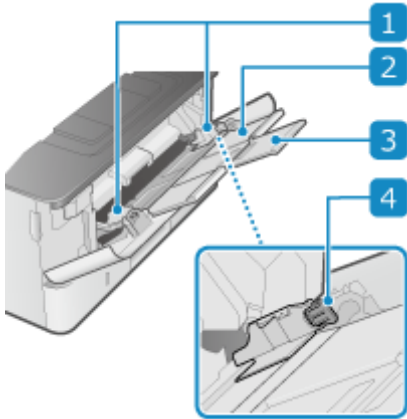

### 1 Paper guides

Align the paper guides against the edges of the paper to properly place the paper.

### 2 Paper tray

Pull out the paper tray when loading paper.

### 3 Extension tray

Open and use this tray when loading large paper sizes.

### 4 Lock release lever

Move the paper guides while pressing the lock release lever.



# Paper Drawer

Load paper that you usually use into the paper drawer. ▶ **Loading Paper in the Paper Drawer(P. 105)**

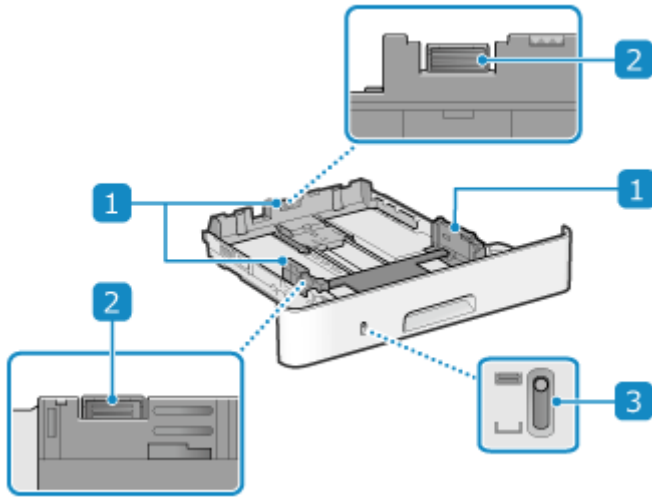

## 1 Paper guides

Align the paper guides against the edges of the paper to properly place the paper.

## 2 Lock release lever

Move the paper guides while pressing the lock release lever.

## 3 Remaining paper display

Shows the amount of paper remaining. The indicator moves down as the amount of paper decreases.

# Usable Paper

The sizes and types of paper that can be used on the machine are shown below.

- ▶ Usable Paper Sizes(P. 18)
- ▶ Usable Paper Types(P. 19)
- ▶ Unusable Paper(P. 21)

## NOTE

- Precautions must be taken when handling and storing paper. ▶ Precautions When Handling Paper(P. 22)

## Usable Paper Sizes

✓ : Usable    ✕ : Not usable

Paper Size	Paper Drawer 1	Paper Drawer 2 <sup>*1</sup>	Multi-purpose Tray	Automatic 2-sided Printing <sup>*2</sup>
A4 <sup>*3*4</sup>	✓	✓	✓	✓
B5	✓	✓	✓	✕
A5 <sup>*5</sup>	✓	✓	✓	✕
A6	✓	✓	✓	✕
Legal (LGL) <sup>*3</sup>	✓	✓	✓	✓
Letter (LTR) <sup>*3*4</sup>	✓	✓	✓	✓
Statement (STMT)	✓	✓	✓	✕
Executive (EXEC)	✓	✓	✓	✕
Oficio <sup>*3</sup>	✓	✓	✓	✓
Oficio (Brazil) <sup>*3</sup>	✓	✓	✓	✓
Oficio (Mexico) <sup>*3</sup>	✓	✓	✓	✓
Letter (Government) <sup>*3</sup>	✓	✓	✓	✕
Legal (Government) <sup>*3</sup>	✓	✓	✓	✕

Paper Size	Paper Drawer 1	Paper Drawer 2 <sup>*1</sup>	Multi-purpose Tray	Automatic 2-sided Printing <sup>*2</sup>
Foolscap/Folio <sup>*3</sup>	✓	✓	✓	✓
Foolscap (Australia) <sup>*3</sup>	✓	✓	✓	×
Legal (India) <sup>*3</sup>	✓	✓	✓	✓
3x5inch	×	×	✓	×
Envelope No.10 (COM10)	×	×	✓	×
Envelope Monarch	×	×	✓	×
Envelope C5	×	×	✓	×
Envelope DL	×	×	✓	×
Custom Paper Size	✓ <sup>*6</sup>	✓ <sup>*6</sup>	✓ <sup>*7</sup>	✓ <sup>*8</sup>

<sup>\*1</sup> The optional Cassette Feeding Module-AH

<sup>\*2</sup> Automatically prints on both sides without having to reload the paper.

<sup>\*3</sup> Enables printing of received I-Faxes.

<sup>\*4</sup> Enables printing of reports and lists.

<sup>\*5</sup> Enables loading of paper in the portrait or landscape orientation.

<sup>\*6</sup> You can use a custom size from 105.0 mm x 148.0 mm to 216.0 mm x 355.6 mm.

<sup>\*7</sup> You can use a custom size from 76.2 mm x 127.0 mm to 216.0 mm x 355.6 mm.

<sup>\*8</sup> You can use a custom size from 210.0 mm x 279.4 mm to 216.0 mm x 355.6 mm.

## Usable Paper Types

You can use non-chlorine paper.

✓ : Usable    × : Not usable

Paper Type	Paper Weight	Paper Drawer 1	Paper Drawer 2 <sup>*1</sup>	Multi-purpose Tray	Automatic 2-sided Printing <sup>*2</sup>
Thin 1 <sup>*3</sup>	60 g/m <sup>2</sup>	✓	✓	✓	✓
Plain 1 <sup>*3*4</sup>	61 g/m <sup>2</sup> to 74 g/m <sup>2</sup>	✓	✓	✓	✓
Plain 2 <sup>*3*4</sup>	75 g/m <sup>2</sup> to 89 g/m <sup>2</sup>	✓	✓	✓	✓
Plain 3 <sup>*4</sup>	90 g/m <sup>2</sup> to 105 g/m <sup>2</sup>	✓	✓	✓	✓

About the Machine

Paper Type	Paper Weight	Paper Drawer 1	Paper Drawer 2 *1	Multi-purpose Tray	Automatic 2-sided Printing *2
Heavy 1	106 g/m <sup>2</sup> to 120 g/m <sup>2</sup>	✓	✓	✓	✓
Heavy 2	121 g/m <sup>2</sup> to 149 g/m <sup>2</sup>	×	×	✓	×
Heavy 3	150 g/m <sup>2</sup> to 199 g/m <sup>2</sup>	×	×	✓	×
Recycled 1 *3*4	61 g/m <sup>2</sup> to 74 g/m <sup>2</sup>	✓	✓	✓	✓
Recycled 2 *3*4	75 g/m <sup>2</sup> to 89 g/m <sup>2</sup>	✓	✓	✓	✓
Labels	—	×	×	✓	×
Color *3*4	61 g/m <sup>2</sup> to 74 g/m <sup>2</sup>	✓	✓	✓	✓
Letterhead 1	61 g/m <sup>2</sup> to 74 g/m <sup>2</sup>	✓	✓	✓	✓
Letterhead 2	75 g/m <sup>2</sup> to 89 g/m <sup>2</sup>	✓	✓	✓	✓
Letterhead 3	90 g/m <sup>2</sup> to 105 g/m <sup>2</sup>	✓	✓	✓	✓
Letterhead 4	106 g/m <sup>2</sup> to 120 g/m <sup>2</sup>	✓	✓	✓	✓
Letterhead 5	121 g/m <sup>2</sup> to 149 g/m <sup>2</sup>	×	×	✓	×
Letterhead 6	150 g/m <sup>2</sup> to 199 g/m <sup>2</sup>	×	×	✓	×
Bond 1	60 g/m <sup>2</sup> to 74 g/m <sup>2</sup>	✓	✓	✓	✓
Bond 2	75 g/m <sup>2</sup> to 104 g/m <sup>2</sup>	✓	✓	✓	✓
Bond 3	105 g/m <sup>2</sup> to 120 g/m <sup>2</sup>	✓	✓	✓	✓
Envelope *5	—	×	×	✓	×

\*1 The optional Cassette Feeding Module-AH

\*2 Automatically prints on both sides without having to reload the paper.

\*3 Enables printing of received I-Faxes.

\*4 Enables printing of reports and lists.

\*5 When you specify a custom size, [Envelope 1] and [Envelope 2] are displayed for the paper type. If you cannot print properly with [Envelope 1], such as due to the toner coming off, try using [Envelope 2].

## Unusable Paper

Before printing, check whether the paper to use is suitable. Do not use the following types of paper, as they can cause paper jams or printing errors:

- Wrinkled, creased, curled, torn, or damp paper<sup>\*1</sup>
- Thin straw paper, very thin paper, coarse paper, glossy paper
- Paper with glue or other adhesive sticking out or label paper whose back side can be easily peeled off
- Paper printed by a thermal transfer printer, back side of paper printed by a thermal transfer printer

<sup>\*1</sup> Printing on damp paper may cause steam to be emitted from the output area or water droplets to adhere to the output part, but this does not indicate a malfunction. This is because the water contained in the paper evaporates due to the heat generated when the toner fixes to the paper. This is more likely to occur when the room temperature is low.

# Precautions When Handling Paper

---

9664-00F

To prevent paper jams and other errors and ensure beautiful printing, you must take precautions when handling and storing paper.

To maintain the quality of printed paper, pay attention when storing and gluing paper.

## ■ Handling and Storing Paper

### **Acclimating the Paper to the Usage Environment**

Before using the paper in the machine, be sure to fully acclimate the paper to the environment where the machine is located. Immediately using paper stored in a location with a different temperature or humidity can cause paper jams or printing errors.

### **Storing Paper Before Use**

- It is recommended that you use paper as soon as possible after opening the package. Any remaining paper should be wrapped in the original package and stored on a flat surface.
- To protect the paper from moisture or dryness, keep the paper wrapped in its package until use.
- Do not store the paper so that it curls or folds.
- Do not store the paper vertically, and do not stack too much paper.
- Do not store the paper in direct sunlight, or in a place with high humidity, dryness, or a drastically different temperature or humidity compared to the usage environment.

## ■ Storing and Gluing Printed Paper

### **Storing Paper**

- Store the paper on a flat surface.
- Do not store the paper together with items made of polyvinyl chloride (PVC) such as a clear folder. The toner may melt, causing the paper to stick to the PVC material.
- Do not store the paper folded or creased. Toner may peel off.
- Do not store the paper in a place with high temperature.
- When storing the paper for a long period of time (two years or longer), store in a binder or similar item.
- Storing the paper for a long period of time can cause a discoloration of the paper, resulting in a discoloration of printed images.

### **Precautions When Gluing Printed Paper**

- Always use insoluble adhesives.
- Before applying adhesive, perform a test using an unneeded printout.
- Allow glued paper to fully dry before stacking.

# Specifications

---

9664-00H

Specifications are subject to change for product improvement, and the contents may be updated depending on products released in the future. For details about product information, see the Canon website.  
<https://global.canon/>

## **Specifications of Main Unit**

- ▶ **Basic Specifications(P. 24)**

## **Specifications of Functions**

- ▶ **Print Specifications(P. 26)**
- ▶ **Network Specifications(P. 28)**
- ▶ **Security and Management Function Specifications(P. 29)**

## **Operating Environment and Supported Software and Servers**

- ▶ **Supported Environment(P. 34)**

## ■ See Also

### **Specifications of Options**

You can check the compatibility of options and their specifications.

- ▶ **Supported Options(P. 4)**

## Basic Specifications

9664-00J

Type	Desktop
Color Supported	Black and White
Print Resolution	600 dpi x 600 dpi
Number of Tones	256
Paper Size	Maximum: 216.0 mm x 355.6 mm Minimum (paper drawer): 105.0 mm x 148.0 mm Minimum (multi-purpose tray): 76.2 mm x 127.0 mm
Paper Type and Weight	▶ Usable Paper(P. 18)
Warm-up time *1	<b>After powering ON</b> 14.0 seconds or less <b>After recovering from sleep mode</b> 4.0 seconds or less
First Print Time (A4)	Approx. 5.0 seconds
Continuous Print Speed *2 (A4)	<b>LBP246dw</b> 40.0 sheets/minute <b>LBP243dw</b> 36.0 sheets/minute
Paper Feeding System and Paper Capacity *3	<b>Paper Drawer x 1</b> 250 sheets (64 g/m <sup>2</sup> , 80 g/m <sup>2</sup> ) <b>Multi-purpose Tray</b> 100 sheets (64 g/m <sup>2</sup> , 80 g/m <sup>2</sup> )
Output System and Output Capacity *3	<b>Output Tray</b> 150 sheets (68 g/m <sup>2</sup> )
Power supply	AC 220 V - 240 V, 3.1 A, 50 Hz/60 Hz
Power Consumption *1	<b>Maximum Power Consumption</b> 1,250 W or less



## About the Machine

	<p><b>During Sleep Mode</b></p> <p>Approx. 0.9 W (USB, wired LAN, or wireless LAN connection)</p> <p><b>With Power Turned OFF</b></p> <p>0.1 W or less</p>
<b>Dimensions</b> (W x D x H)	399 mm x 373 mm x 249 mm
<b>Weight</b> (Not including toner cartridges)	Approx. 8.7 kg
<b>Maximum Occupancy Space</b>	<p>399 mm x 881 mm x 378 mm</p> <p>* Provide a space of at least 100 mm around the machine.</p>
<b>Memory Capacity</b>	RAM: 1 GB
<b>Usage Environment</b>	<p>Temperature: 10 °C to 30 °C</p> <p>Humidity: 20% to 80% RH (no condensation)</p>

\*1 May vary depending the usage environment and usage conditions.

\*2 Print speed is measured based on internal testing using A4 size paper printed with 100% print ratio to original on one-sided paper. Internal testing involved continuously printing the same one page of content on plain paper. Print speed may vary depending on paper type, paper size or paper feeding direction. The device may automatically pause or slow down in order to adjust printer condition such as controlling temperature of a certain unit or limiting impact to image quality during continuous printing.

\*3 May vary depending on the installation environment and paper to be used.

# Print Specifications

9664-00K

- ▶ **UFR II Printer Function(P. 26)**
- ▶ **PS Printer Function(P. 26)**
- ▶ **PCL Printer Function(P. 27)**

## UFR II Printer Function

<b>Type</b>	Internal
<b>Print Size</b>	▶ <b>Usable Paper(P. 18)</b>
<b>Continuous Print Speed</b>	Same as "Continuous Print Speed" for main unit ▶ <b>Basic Specifications(P. 24)</b>
<b>Resolution</b>	<b>Data Processing</b> 1,200 dpi x 1,200 dpi, 600 dpi x 600 dpi
<b>Page Description Language (PDL)</b>	UFR II
<b>Protocol Supported</b>	TCP/IP: LPD, Port9100, IPP, IPPS, FTP, WSD
<b>Resident Fonts</b>	None
<b>Interface</b>	<b>USB</b> USB 2.0 Hi-Speed <b>Wired LAN</b> 10Base-T, 100Base-TX, 1000Base-T (IEEE 802.3 compliant) <b>Wireless LAN</b> IEEE 802.11b, IEEE 802.11g, IEEE 802.11n

## PS Printer Function

<b>Model Type</b>	Internal
<b>Print Size</b>	▶ <b>Usable Paper(P. 18)</b>
<b>Continuous Print Speed</b>	Same as "Continuous Print Speed" for main unit ▶ <b>Basic Specifications(P. 24)</b>
<b>Resolution</b>	<b>Data Processing</b> 1,200 dpi x 1,200 dpi, 600 dpi x 600 dpi

<b>Page Description Language (PDL)</b>	Adobe®PostScript®3™
<b>Protocol Supported</b>	TCP/IP: LPD, Port9100, IPP, IPPS, FTP, WSD
<b>Resident Fonts</b>	136 Roman
<b>Interface</b>	<p><b>USB</b></p> <p>USB 2.0 Hi-Speed</p> <p><b>Wired LAN</b></p> <p>10Base-T, 100Base-TX, 1000Base-T (IEEE 802.3 compliant)</p> <p><b>Wireless LAN</b></p> <p>IEEE 802.11b, IEEE 802.11g, IEEE 802.11n</p>

## PCL Printer Function

<b>Type</b>	Internal
<b>Print Size</b>	▶ <b>Usable Paper(P. 18)</b>
<b>Continuous Print Speed</b>	<p>Same as "Continuous Print Speed" for main unit</p> <p>▶ <b>Basic Specifications(P. 24)</b></p>
<b>Resolution</b>	<p><b>Data Processing</b></p> <p>1,200 dpi x 1,200 dpi, 600 dpi x 600 dpi</p>
<b>Page Description Language (PDL)</b>	PCL6, PCL5
<b>Protocol Supported</b>	TCP/IP: LPD, Port9100, IPP, IPPS, FTP, WSD
<b>Resident Fonts</b>	45 Roman, 10 Bitmap fonts
<b>Interface</b>	<p><b>USB</b></p> <p>USB 2.0 Hi-Speed</p> <p><b>Wired LAN</b></p> <p>10Base-T, 100Base-TX, 1000Base-T (IEEE 802.3 compliant)</p> <p><b>Wireless LAN</b></p> <p>IEEE 802.11b, IEEE 802.11g, IEEE 802.11n</p>

# Network Specifications

9664-00L

## ■ Common

<b>Protocol Supported</b>	TCP/IP  Frame type: Ethernet II Print applications: LPD, Raw, IPP, IPPS, FTP, WSD, Mopria, AirPrint, Windows10 Mobile Print, Windows11 Mobile Print
---------------------------	--

## ■ Wired LAN

<b>Interface</b>	10BASE-T, 100BASE-TX, 1000BASE-T (RJ-45)
------------------	--

## ■ Wireless LAN

<b>Standard</b>	IEEE 802.11b, IEEE 802.11g, IEEE 802.11n
<b>Transmission Method</b>	IEEE 802.11b (Modulation system: DS-SS) IEEE 802.11g (Modulation system: OFDM method) IEEE 802.11n (Modulation system: OFDM method)
<b>Communication Mode</b>	Infrastructure Mode Access Point Mode
<b>Security</b> (Encryption Method)	<b>Infrastructure Mode</b> 128 (104) / 64 (40) bit WEP WPA-PSK (TKIP / AES-CCMP) WPA2-PSK (TKIP / AES-CCMP) WPA-EAP (AES-CCMP) WPA2-EAP (AES-CCMP) <b>Access Point Mode</b> WPA2-PSK (AES-CCMP)
<b>Setup Method</b>	WPS (Wi-Fi Protected Setup), Manual setup

# Security and Management Function Specifications

9664-00R

- ▶ Firewall(P. 29)
- ▶ IPSec(P. 29)
- ▶ Keys and Certificates(P. 30)
- ▶ Definition of "Weak Encryption"(P. 31)
- ▶ TLS(P. 32)

## Firewall

- Up to 16 IP addresses (or ranges of IP addresses) can be specified for both IPv4 and IPv6.
- Up to 32 MAC addresses can be specified.

## IPSec

IPSec of the machine conforms to RFC2401, RFC2402, RFC2406, and RFC4305.

<b>Operating system of connected device</b>	Windows 8.1 Windows 10 Windows 11
<b>Connection mode</b>	Transport mode
<b>Key exchange protocol</b>	IKEv1 (main mode)
	<b>Authentication method</b> Pre-shared key Digital signature
	<b>Hash algorithm (and key length)</b> HMAC-SHA1-96 HMAC-SHA2 (256 bits or 384 bits)
	<b>Encryption algorithm (and key length)</b> 3DES-CBC AES-CBC (128 bits, 192 bits, 256 bits)
	<b>Key exchange algorithm/group (and key length)</b> Diffie-Hellman (DH)  Group 14 (2048 bits) ECDH-P256 (256 bits) ECDH-P384 (384 bits)

ESP	<b>Hash algorithm</b> HMAC-SHA1-96
	<b>Encryption algorithm (and key length)</b> 3DES-CBC AES-CBC (128 bits, 192 bits, 256 bits)
	<b>Hash/encryption algorithm (and key length)</b> AES-GCM (128 bits, 192 bits, 256 bits)
AH	<b>Hash algorithm</b> HMAC-SHA1-96

## NOTE

- IPSec supports communication to a unicast address (single device).

## Keys and Certificates

The following keys and certificates are supported:

### ■ Self-generated Key and Self-signed Certificate or CSR

<b>Public key algorithm (and key length)</b>	RSA (512 bits, 1024 bits, 2048 bits, 4096 bits) DSA (1024Bits, 2048Bits, 3072Bits) ECDSA (P256, P384, P521)
<b>Certificate signature algorithm</b>	RSA: SHA-1* <sup>1</sup> , SHA-256, SHA-384* <sup>2</sup> , SHA-512* <sup>2</sup> DSA: SHA-1* <sup>1</sup> ECDSA: SHA-1* <sup>1</sup> , SHA-256, SHA-384, SHA-512
<b>Certificate thumbprint algorithm</b>	SHA1

\*<sup>1</sup> Available only when installed by using the Remote UI.

\*<sup>2</sup> SHA384-RSA and SHA512-RSA are available only when the RSA key length is 1024 bits or more.

### ■ Key and Certificate or CA Certificate for Installation

<b>Format</b>	<b>Key</b> PKCS#12* <sup>1</sup> <b>CA certificate</b>
---------------	--

	X.509 DER format/PEM format
<b>File extension</b>	<b>Key</b> ".p12" or ".pfx" <b>CA certificate</b> ".cer" or ".pem"
<b>Public key algorithm (and key length)</b>	RSA (512 bits, 1024 bits, 2048 bits, 4096 bits) DSA (1024 bits, 2048 bits, 3072 bits) ECDSA (P256, P384, P521)
<b>Certificate signature algorithm</b>	RSA: SHA-1* <sup>2</sup> , SHA-256, SHA-384* <sup>3</sup> , SHA-512* <sup>3</sup> DSA: SHA-1* <sup>2</sup> ECDSA: SHA-1* <sup>2</sup> , SHA-256, SHA-384, SHA-512
<b>Certificate thumbprint algorithm</b>	SHA1

\*1 Requirements for the certificate contained in a key are pursuant to CA certificates.

\*2 Available only when installed by using the Remote UI.

\*3 SHA384-RSA and SHA512-RSA are available only when the RSA key length is 1024 bits or more.

## NOTE

- The machine does not support use of a certificate revocation list (CRL).

## Definition of "Weak Encryption"

When [Prohibit Use of Weak Encryption] in [Encryption Settings] is set to [On], the use of the following algorithms is prohibited. [▶\[Encryption Settings\]\(P. 353\)](#)

<b>Hash</b>	MD4, MD5, SHA-1
<b>HMAC</b>	HMAC-MD5
<b>Common key encryption</b>	RC2, RC4, DES
<b>Public key encryption</b>	RSA encryption (512 bits/1024 bits) RSA signature (512 bits/1024 bits) DSA (512 bits/1024 bits) DH (512 bits/1024 bits)

## NOTE

- Even when [Prohibit Key/Cert. with Weak Encryption] in [Encryption Settings] is set to [On], the hash algorithm SHA-1, which is used for signing a root certificate, can be used.

## TLS

The following combinations of the TLS version and algorithm are usable:

✓ : Usable    — : Not usable

Algorithm	TLS Version			
	TLS 1.3	TLS 1.2	TLS 1.1	TLS 1.0
<b>Encryption Algorithm</b>				
AES-CBC (256bit)	—	✓	✓	✓
AES-CBC (128bit)	—	✓	✓	✓
AES-GCM (256bit)	✓	✓	—	—
AES-GCM (128bit)	✓	✓	—	—
3DES-CBC	—	✓	✓	✓
CHACHA20-POLY1305	✓	—	—	—
<b>Key Exchange Algorithm</b>				
RSA	—	✓	✓	✓
ECDHE	✓	✓	✓	✓
X25519	✓	—	—	—
<b>Signature Algorithm</b>				
RSA	✓	✓	✓	✓
ECDSA	✓	✓	✓	✓
<b>HMAC Algorithm</b>				
SHA1	—	✓	✓	✓
SHA256	✓	✓	—	—



Algorithm	TLS Version			
	TLS 1.3	TLS 1.2	TLS 1.1	TLS 1.0
SHA384	✓	✓	—	—

# Supported Environment

9664-00S

- ▶ Operating Environment(P. 34)
- ▶ Supported Software and Servers(P. 34)

## Operating Environment

<b>AirPrint Operating Environment</b>	▶ Using AirPrint Application to Print Data(P. 183)
<b>Remote UI Operating Environment</b> *1	<p><b>Windows</b></p> <p>Microsoft Edge</p> <p>Google Chrome</p> <p><b>macOS</b></p> <p>Safari 11</p> <p>Google Chrome</p> <p><b>Android</b></p> <p>Google Chrome</p> <p>UC Browser</p> <p><b>iOS</b></p> <p>Safari 11</p> <p>UC Browser</p>

\*1 You must set your Web browser to enable cookies and use JavaScript.

## Supported Software and Servers

<b>I-Fax Receiving Server Software</b>	<p>Microsoft Exchange Server 2013</p> <p>Microsoft Exchange Server 2016</p> <p>Microsoft Exchange Server 2019</p> <p>Lotus Domino R7.0</p> <p>Qpopper 4.1.0</p>
--	---

## Recommended Functions

---

9664-00U

This section introduces recommended functions that can be useful for your purpose and help you solve problems, such as to save paper and power, and improve operations.

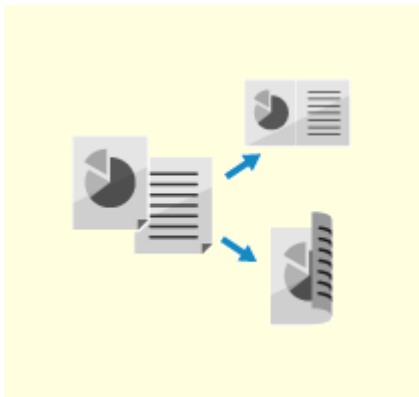

▶ **Cost Savings(P. 36)**



▶ **Making Operations More Efficient(P. 37)**

# Cost Savings

---

9664-0C8

This machine can help you save costs on paper and power.

## Saving Paper

---

### Saving Paper When Printing

You can print on both sides of the paper, and print multiple pages on one sheet of paper.

- ▶ **Printing from a Computer(P. 154)**
- ▶ **Changing the Print Settings of the Received I-Fax(P. 166)**

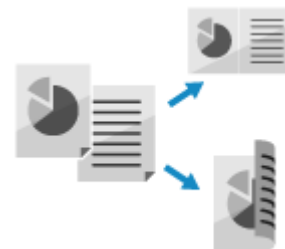

## Restricting and Managing the Number of Sheets of Paper

---

You can allocate a Department ID to each user or group to manage the number of pages printed per Department ID.

- ▶ **Authenticating Users and Managing Groups with Department ID (Department ID Management)(P. 194)**

## Saving Energy

---

You can configure the machine to enter sleep mode when not in use to save energy. The power of the machine does not turn OFF, so it can quickly resume operations.

- ▶ **Reducing Power Consumption (Sleep Mode)(P. 89)**

# Making Operations More Efficient

---

9664-00X

You can print data even in an environment where a computer cannot be used.

## Printing Data Without Using a Computer

---

### Printing Data from a Smartphone or Tablet

You can print data from a mobile device connected to the machine while using an application. The machine supports direct connection for easy connection setup without having to use a wireless LAN router.

▶ **Linking with Mobile Devices(P. 171)**



## Customizing Control Panel for Ease of Use

---

You can rearrange the order of the items on the [Home] screen for greater usability.

▶ **Customizing the [Home] Screen(P. 102)**

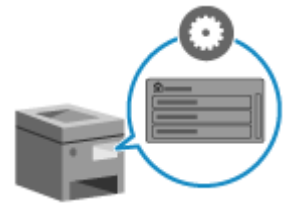

# Setting Up

<b>Setting Up</b> .....	39
<b>Configuring the Default Settings (Setup Guide)</b> .....	40
<b>Setting Up the Network</b> .....	43
Selecting Wired or Wireless LAN .....	45
Connecting to a Wired LAN .....	46
Connecting to a Wireless LAN .....	47
Connecting to a Wireless LAN by Using the Router Button (Push Button Mode) .....	50
Connecting to a Wireless LAN by Entering a PIN Code (WPS PIN Code Mode) .....	51
Connecting to a Wireless LAN by Searching for a Router (Access Point Setup Method) .....	53
Connecting to a Wireless LAN by Setting the Details (Manual Setup Method) .....	55
Setting IPv4 Addresses .....	58
Setting IPv6 Addresses .....	60
Configuring Your Machine for Your Network Environment .....	62
Manually Configuring the Ethernet Settings .....	63
Configuring DNS .....	64
Configuring SMB .....	67
Configuring WINS .....	68
Configuring SNMP .....	69
Configuring SNTP .....	72
Configuring SLP Communication .....	74
Checking the Network Status and Settings .....	76
<b>Installing Software and Drivers to the Computer</b> .....	79

# Setting Up

9664-00Y

After installing the machine, configure the required settings to enable use of the functions by performing the following steps.

Steps 1 and 2 are the machine settings.

Step 3 is the setting for using the machine from a computer. Configure this setting for each computer using the machine.

## Step 1

When you turn ON the machine for the first time, the screen (Setup Guide) for setting the items required for using the machine is displayed. Configure the settings by following the instructions on the screen.

▶ **Configuring the Default Settings (Setup Guide)(P. 40)**



## Step 2

Configure the network settings not included in the Setup Guide. If you did not connect to the network using the Setup Guide, do that during this step.

▶ **Setting Up the Network(P. 43)**



## Step 3

Install the software required to use the machine and printer driver on your computer.

▶ **Installing Software and Drivers to the Computer(P. 79)**

## ■ See Also

### Implementing Measures to Prevent Unauthorized Access

It is important to provide measures against security risks when using the machine in a network environment. Check examples of measures that you can take with the machine.

▶ **Measures to Prevent Unauthorized Access(P. 7)**

### Checking Available Functions

The functions available on the machine vary depending on the model. Check the functions that are available on your model.

▶ **Supported Functions and Options(P. 3)**

### Configuring the Settings Required to Use the Functions of the Machine

Additional settings may be required depending on your model. For details about the settings required for each function, see the following:

▶ **Printing Preparations(P. 137)**

▶ **Preparations for Linking with Mobile Devices(P. 172)**

### Importing Settings Data from Another Machine

You can share settings data with other machines to save time on configuring the settings. You can export data from another machine of the same model to a computer and import that data to the machine so as to share the settings.

▶ **Importing and Exporting the Settings(P. 268)**

# Configuring the Default Settings (Setup Guide)

9664-010

When you turn ON the machine for the first time, the screen (Setup Guide) for setting the items required for using the machine is displayed. Configure the settings using the procedure below by following the instructions on the screen.

- ▶ **Step 1: Setting the Display Language and Country or Region(P. 40)**
- ▶ **Step 2: Setting the Date and Time(P. 40)**
- ▶ **Step 3: Setting Remote UI(P. 41)**
- ▶ **Step 4: Connecting to a Wireless LAN(P. 41)**

## NOTE

- These settings can only be configured one time using the Setup Guide when starting the machine for the first time. To change the settings configured with the Setup Guide at a later time, set the items in Steps 1 to 4 individually. For the details of each setting, see the following.
  - ▶ **Setting the Date and Time(P. 254)**
  - ▶ **Setting the PIN to Use for Remote UI(P. 239)**
  - ▶ **Connecting to a Wireless LAN(P. 47)**

## Step 1: Setting the Display Language and Country or Region

Set the language displayed on the control panel screen and reports to be printed. Next, set the country or region where the machine is used.

**1 On the [Language] screen, select the display language and press **OK**.**

**2 Select [Yes], and then press **OK**.**

- ⇒ The display language is set, and the [Select Country/Region] screen is displayed. Depending on the country or region, the [Select Country/Region] screen is not displayed and the [Time Zone] screen is displayed. When the [Time Zone] screen is displayed, proceed to "Step 2: Setting the Date and Time." ▶ **Step 2: Setting the Date and Time(P. 40)**

**3 On the [Select Country/Region] screen, select the country or region, and press **OK**.**

- ⇒ The country or region is set, and the [Time Zone] screen is displayed.

## Step 2: Setting the Date and Time

The date and time are used as the reference for the functions using date and time information, and therefore, they need to be set accurately.

**1 On the [Time Zone] screen, select your time zone and press **OK**.**

- Set the time zone (UTC<sup>\*1</sup>) and Daylight Saving Time according to the region where this machine is installed. <sup>\*1</sup> The UTC (Coordinated Universal Time) is a coordinated universal time that is standard for all parts of the world. Internet-based communication relies on the UTC being set correctly.



## 2 On the [Current Time Set.] screen, enter the date and time, and press **OK**.

⇒ The time and date are set, and the Remote UI confirmation screen is displayed.

### Step 3: Setting Remote UI

With Remote UI, you can use a Web browser on a computer to check the operation status of the machine, change the settings, and perform other operations.

Set the Remote UI Access PIN for using Remote UI to prevent unauthorized access to the machine.

#### 1 On the Remote UI confirmation screen, select [<Yes>] and press **OK**.

To set the Remote UI Access PIN at a later time, select [No] ► press **OK** proceed to "Step 4: Connecting to a Wireless LAN." ► **Step 4: Connecting to a Wireless LAN(P. 41)**

#### 2 Confirm the message ► press **OK** ► confirm the message ► select [Yes] ► press **OK**.

⇒ The [Remote UI Access PIN] screen is displayed.

Restrict the use of Remote UI to only those users who know the Remote UI Access PIN.

#### 3 Enter the Remote UI Access PIN, and press **OK**.

Specify any number. You cannot set a PIN consisting of all zeros, such as "00" or "0000000."

#### 4 Enter the PIN again, and press **OK**.

⇒ After the message [Settings applied.] appears, the screen for confirming the wireless LAN connection is displayed.

### Step 4: Connecting to a Wireless LAN

Connect to the network using wireless local area network (LAN).

#### 1 On the screen for confirming the wireless LAN connection, select [Yes] and press **OK**.

- If the machine is not connected to a wireless LAN, select [No] and press **OK**. The settings configured in the Setup Guide are applied.
- When connecting to a wired LAN, configure the wired LAN connection settings after exiting the Setup Guide. ► **Selecting Wired or Wireless LAN(P. 45)**

#### 2 Select the Wireless LAN connection type, and connect to the Wireless LAN.

⇒ When the connection to the wireless LAN is completed, the settings configured in the Setup Guide are applied.

When you exit the Setup Guide, the [Home] screen is displayed. ► **[Home] Screen(P. 94)**

Depending on your wireless LAN router, the connection type and security standards may vary. Check for a connection type and security standard that are supported by both the wireless LAN router and the machine,

and then establish a connection according to the connection type. For the standards and procedure, see the following:

▶ **Connecting to a Wireless LAN(P. 47)**

# Setting Up the Network

9664-011

To operate the machine from a computer or to connect to a server, you must connect the machine to a network. Use the procedure below to connect the machine to a network and configure the settings of the machine according to the network environment.

Administrator privileges are required to set up the network.

Set the System Manager ID and System Manager PIN. [▶System Manager ID and PIN\(P. 6\)](#)

## IMPORTANT

- Connecting the machine to a network without proper security measures may leak information from the machine to third parties. [▶Protecting the Network\(P. 202\)](#)

### ■ Preparing to Set Up the Network

- Provide an Ethernet cable and router according to the usage environment of the machine.
- Check the information of the network environment used by the machine and the required network settings. For details, contact the network administrator.
- Check that the computer and router to be used in the network are properly connected, and complete the network settings. For details on the connection method, see the manuals of the devices or contact the manufacturer.

### ■ Network Settings Procedure

#### Step 1

Select whether to use wired or wireless LAN and connect to the network.

##### To connect to a Wired LAN

- [▶Selecting Wired or Wireless LAN\(P. 45\)](#)
- [▶Connecting to a Wired LAN\(P. 46\)](#)

##### To connect to a Wireless LAN

- [▶Selecting Wired or Wireless LAN\(P. 45\)](#)
- [▶Connecting to a Wireless LAN\(P. 47\)](#)



#### Step 2

Set the IP address.

- By default, when the machine connects to a wired or wireless LAN, an IP address is obtained automatically and set to the machine.
- To use a specific IP address, set this manually.
  - [▶Setting IPv4 Addresses\(P. 58\)](#)
  - [▶Setting IPv6 Addresses\(P. 60\)](#)

\* When setting an IP address manually, you cannot use the control panel to configure some IPv6 address settings. It is recommended to use the control panel to set the IPv4 address, and then use Remote UI to set the IPv6 address.



#### Step 3

Configure the settings of the machine according to the network environment, as needed.

▶ **Configuring Your Machine for Your Network Environment(P. 62)**

\* You cannot use the control panel to configure some of the settings. It is recommended that you configure the settings using Remote UI in Step 3

■ **Checks after Configuring the Network Settings**

Check that the machine is properly connected to the network.

Check the IP address and MAC address of the machine and other information, as needed.

▶ **Checking the Network Status and Settings(P. 76)**

## Selecting Wired or Wireless LAN

9664-012

Set whether to connect the machine to the network using a wired or wireless LAN.

If you want to switch from wired LAN to wireless LAN, you can make the setting during the procedure for connecting to wireless LAN. **▶Connecting to a Wireless LAN(P. 47)**

\* You cannot connect to a wired LAN and wireless LAN at the same time.

Use the control panel to configure the settings. You cannot configure the settings using Remote UI from a computer. Administrator privileges are required.

**1** On the control panel, select [Menu] in the [Home] screen and press **OK**. **▶[Home] Screen(P. 94)**

**2** Press [Preferences] **▶ OK ▶ [Network] ▶ OK ▶ [Select Wired/Wireless LAN] ▶ OK**.

If the login screen appears, enter the System Manager ID and PIN, and then press **ID**. **▶System Manager ID and PIN(P. 6)**

**3** Select [Wired LAN] or [Wireless LAN] and press **OK**.

⇒ The message [Settings applied.] appears.  
Next, connect to the wired or wireless LAN.

**▶Connecting to a Wired LAN(P. 46)**

**▶Connecting to a Wireless LAN(P. 47)**

### IMPORTANT

#### When Switching between Wired and Wireless LAN

- Any installed drivers must be uninstalled and then reinstalled.  
For details about uninstalling and installing drivers, see the driver manual at the online manual site.  
<https://oip.manual.canon/>

## Connecting to a Wired LAN

---

9664-013

Connect a computer to the machine via a router. Use an Ethernet cable to connect the machine to the router.

### 1 Connect an Ethernet cable to the machine and router.

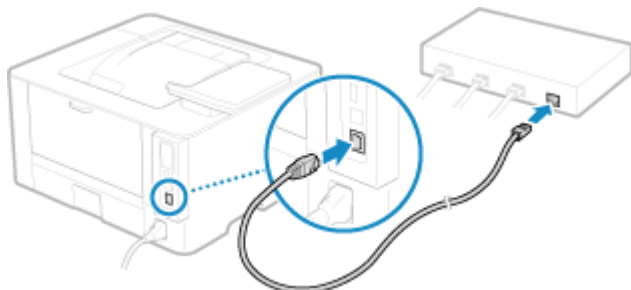

Insert the connector all the way into the port until it clicks in place.

### 2 Wait a few minutes.

▣ By default, the IP address is set automatically.  
To use a specific IP address, set this manually.

▶ **Setting IPv4 Addresses(P. 58)**

▶ **Setting IPv6 Addresses(P. 60)**

## Connecting to a Wireless LAN

9664-014

Connect a computer to the machine via a wireless LAN router (access point).

Depending on your wireless LAN router, the connection type and security standards may vary. Check for a connection type and security standard that are supported by both the wireless LAN router and the machine, and then establish a connection according to the connection type.

Depending on the connection type, you must enter the security information of the wireless LAN router.

▶ **Checking the Connection Types and Security Standards Supported by the Machine**(P. 47)

▶ **Wireless LAN Router Information Required for Connection**(P. 48)

### IMPORTANT

#### Connect with a Secure Network Environment

- The radio waves used for wireless communication can reach beyond walls and other obstructions within a certain range. Therefore, connecting the machine to a network without proper security measures may leak personal data and other information to third parties. Connect the machine to a wireless LAN at your own discretion and responsibility. ▶ **Protecting the Network**(P. 202)

### NOTE

#### Reducing Power Consumption

- When Power Save Mode is enabled, the machine regularly enters the power save state according to the signal transmitted by the wireless LAN router. ▶ **[Power Save Mode]**(P. 294)

## Checking the Connection Types and Security Standards Supported by the Machine

### ■ Connection Type

Connect using a type that is supported by your wireless LAN router. To specify the authentication, encryption, or other security method in detail, use the manual setup method to connect.

The following connection types are supported by the machine:

#### Push Button Mode (WPS)



If the wireless LAN router has the above symbol on the package or the button of the device, you can easily connect by pressing the button.

▶ **Connecting to a Wireless LAN by Using the Router Button (Push Button Mode)**(P. 50)

#### WPS PIN Code Mode

If you are using a WPS router that does not support the push button mode, enter the PIN code to connect.

▶ **Connecting to a Wireless LAN by Entering a PIN Code (WPS PIN Code Mode)**(P. 51)

\* If the wireless LAN router is set up to use WEP authentication, you may not be able to connect with WPS. In this case, use the manual setup method to connect.

## Access Point Setup Method

Search for the wireless LAN router from the machine, and enter the network key manually to connect.

### 🔍 Connecting to a Wireless LAN by Searching for a Router (Access Point Setup Method)(P. 53)

When you connect with the access point setup method, the following authentication and encryption methods are set:

- WEP authentication method: Open System
- Encryption for WPA/WPA2: AES-CCMP or TKIP is set automatically according to the selected wireless LAN router.

To specify a different authentication or encryption method, use the manual setup method to connect.

## Manual Setup Method

In addition to the SSID and network key, manually enter all the wireless LAN settings such as the authentication and encryption methods to connect.

### 🔍 Connecting to a Wireless LAN by Setting the Details (Manual Setup Method)(P. 55)

## ■ Security Standards

The wireless LAN of the machine supports the security standards below. For details on whether your wireless LAN router supports these standards, see the manual of the wireless LAN router or contact the manufacturer.

- WEP
- WPA-PSK
- WPA2-PSK
- WPA-EAP
- WPA2-EAP

## Wireless LAN Router Information Required for Connection

When connecting with the access point setup method or the manual setup method, you must set the information below.

This information is listed on the main unit of the wireless LAN router. For details, see the manual of the wireless LAN router or contact the manufacturer.

### SSID

This is the name used to identify the wireless LAN router. This may be listed as the access point name or network name.

### Network Key

This is the keyword used for data encryption or the password used for network authentication. This may be listed as the encryption key, WEP key, WPA/WPA2 passphrase, or pre-shared key (PSK).

### Security Standards

These are required when connecting with the manual setup method. Check the following information:

#### Security Standards

- WEP
- WPA-PSK
- WPA2-PSK
- WPA-EAP
- WPA2-EAP

#### WEP Authentication Method

- Open System



- Shared Key

**Encryption for WPA/WPA2**

- TKIP
- AES-CCMP
- IEEE 802.1X Authentication

# Connecting to a Wireless LAN by Using the Router Button (Push Button Mode)

If your wireless LAN router supports WPS push button mode, you can easily set up a connection simply by using the control panel of the machine and the button on the wireless LAN router.

Administrator privileges are required to connect to a wireless LAN.

## 1 On the control panel, select [Wireless LAN Set.] in the [Home] screen and press **OK**. ▶ [Home] Screen(P. 94)

⇒ The [Select Network] screen is displayed.

- If the login screen appears, enter the System Manager ID and PIN, and then press **ID**. ▶ **System Manager ID and PIN(P. 6)**
- If the message [Enable the wireless LAN?] appears, select [Yes] and press **OK**.
- If the message [Cannot find the access point.] appears, press **OK**.

## 2 Select [Other Connections] and press **OK**.

## 3 Select [WPS Push Button Mode] and press **OK**.

⇒ The machine starts searching for an access point.

## 4 After the search for an access point starts, press the button on the wireless LAN router within two minutes.

Press the button within two minutes. (Depending on the wireless LAN router, you may have to press and hold the button.)

\* For details on how to operate the button, see the manual of your wireless LAN router.

## 5 When [Connected.] appears on the control panel, press **OK**.

⇒ When the machine is connected to the wireless LAN, [ (ip) ] appears on the [Home] screen.

## 6 Wait a few minutes.

- ⇒ By default, an IP address is set automatically.  
To use a specific IP address, set this manually.
  - ▶ **Setting IPv4 Addresses(P. 58)**
  - ▶ **Setting IPv6 Addresses(P. 60)**

## NOTE

### If an Error Message Appears during Operation and a Connection Cannot Be Established

- Press **OK**, and repeat the procedure starting from Step 2.

# Connecting to a Wireless LAN by Entering a PIN Code (WPS PIN Code Mode)

9664-016

When the wireless LAN router supports WPS PIN code mode, you can establish a connection by registering a PIN code generated on the machine to the wireless LAN router. Use a computer to register the PIN code.

Administrator privileges are required to connect to a wireless LAN.

## Required Preparations

- Access the wireless LAN router from a computer, and enable registration of a WPS PIN code.
  - \* For details on how to register a WPS PIN code, see the manual of your wireless LAN router.

### 1 On the control panel, select [Wireless LAN Set.] in the [Home] screen and press **OK**.

#### [Home] Screen(P. 94)

⇒ The [Select Network] screen is displayed.

- If the login screen appears, enter the System Manager ID and PIN, and then press **ID**.  **System Manager ID and PIN(P. 6)**
- If the message [Enable the wireless LAN?] appears, select [Yes] and press **OK**.
- If the message [Cannot find the access point.] appears, press **OK**.

### 2 Select [Other Connections] and press **OK**.

### 3 Select [WPS PIN Code Mode] and press **OK**.

⇒ A PIN code is generated.

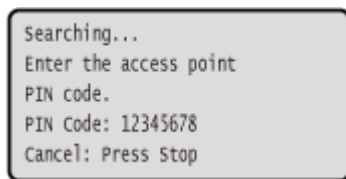

Once this screen is displayed, you must register the WPS PIN code to the wireless LAN router within 10 minutes.

### 4 Access the wireless LAN router from a computer, and register the WPS PIN code to the router.

### 5 When [Connected.] appears on the control panel, press **OK**.

⇒ When the machine is connected to the wireless LAN, [  ] appears on the [Home] screen.

### 6 Wait a few minutes.

- ▣ Wait a few minutes. By default, an IP address is set automatically.  
To use a specific IP address, set this manually.

- ▶ **Setting IPv4 Addresses(P. 58)**

- ▶ **Setting IPv6 Addresses(P. 60)**

## NOTE

### If an Error Message Appears during Operation and a Connection Cannot Be Established

- Press **OK**, and repeat the procedure starting from Step 2.

## Connecting to a Wireless LAN by Searching for a Router (Access Point Setup Method)

Search for a wireless LAN router (access point) to which to connect, and enter the network key.

When you connect with the access point setup method, the following authentication and encryption methods are set:

- WEP authentication method: Open System
- Encryption for WPA/WPA2: AES-CCMP or TKIP is set automatically according to the selected wireless LAN router.

To specify a different authentication or encryption method, use the manual setup method to connect. ▶

**Connecting to a Wireless LAN by Setting the Details (Manual Setup Method)(P. 55)**

Administrator privileges are required to connect to a wireless LAN.

### Required Preparations

- Prepare the information of the wireless LAN router (SSID or network key) to which you want to connect, and keep it close by. ▶ **Wireless LAN Router Information Required for Connection(P. 48)**
- When connecting to a wireless LAN router supporting WPA-EAP or WPA2-EAP for the security standard, set IEEE 802.1X. ▶ **Using IEEE 802.1X(P. 215)**

### 1 On the control panel, select [Wireless LAN Set.] in the [Home] screen and press **OK**. ▶ **[Home] Screen(P. 94)**

⇒ The [Select Network] screen is displayed.

- If the login screen appears, enter the System Manager ID and PIN, and then press **ID**. ▶ **System Manager ID and PIN(P. 6)**
- If the message [Enable the wireless LAN?] appears, select [Yes] and press **OK**.
- If the message [Cannot find the access point.] appears, check that the router is discoverable. ▶ **Cannot Connect to Wireless LAN(P. 424)**

### 2 Select the SSID of the wireless LAN to which you want to connect, and press **OK**.

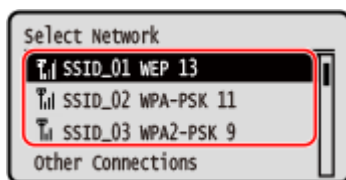

⇒ The Network Key input screen is displayed.

When selecting the SSID of the wireless LAN router supporting WPA-EAP or WPA2-EAP for the security standard, the message [IEEE 802.1X Settings values will be applied to connect.] appears. Press **OK**, and proceed to Step 4.

If you cannot find the wireless LAN router to which you want to connect, check that the router is discoverable. ▶ **Cannot Connect to Wireless LAN(P. 424)**

### 3 Enter the network key, and press [**<Apply>**] ▶ **OK**.

**4** Press [Yes] ► **OK**.

**5** When [Connected.] is displayed on the control panel, press **OK**.

⇒ When the machine is connected to the wireless LAN, [  ] appears on the [Home] screen.

**6** Wait a few minutes.

⇒ By default, an IP address is set automatically.  
To use a specific IP address, set this manually.

▶ **Setting IPv4 Addresses(P. 58)**

▶ **Setting IPv6 Addresses(P. 60)**

## NOTE

### If an Error Message Appears during Operation and a Connection Cannot Be Established

- Press **OK**, check the information (SSID or network key) of the wireless LAN router to which you want to connect, and repeat the procedure starting from Step 2.

# Connecting to a Wireless LAN by Setting the Details (Manual Setup Method)

You can connect to a wireless LAN router by manually entering all information of the router such as the SSID, network key, and security settings.

Administrator privileges are required to connect to a wireless LAN.

## Required Preparations

- Prepare the information of the wireless LAN router to which you want to connect, and keep it close by. [▶ Wireless LAN Router Information Required for Connection\(P. 48\)](#)
- When connecting to a wireless LAN router supporting WPA-EAP or WPA2-EAP for the security standard, set IEEE 802.1X. [▶Using IEEE 802.1X\(P. 215\)](#)

### 1 On the control panel, select [Wireless LAN Set.] in the [Home] screen and press **OK**. [▶ \[Home\] Screen\(P. 94\)](#)

⇒ The [Select Network] screen is displayed.

- If the login screen appears, enter the System Manager ID and PIN, and then press **ID**. [▶System Manager ID and PIN\(P. 6\)](#)
- If the message [Enable the wireless LAN?] appears, select [Yes] and press **OK**.
- If the message [Cannot find the access point.] appears, select [Close] and press **OK**.

### 2 Select [Other Connections] and press **OK**.

### 3 Select [Manually Enter Network Name] and press **OK**.

⇒ The SSID input screen is displayed.

### 4 Enter the SSID, select [<Apply>], and press **OK**.

⇒ The [Security Settings] screen is displayed.

### 5 Select the security standard, and set the authentication and encryption.

#### ■ When using WEP

#### 1 Select [WEP] and press **OK**.

⇒ The [802.11 Authentication] screen is displayed.

#### 2 Select the authentication method.

**[Open System]**

Uses open authentication.

\* When you select this authentication method, an authentication error occurs when connected to a wireless LAN router that uses a shared key. The machine setting changes to [Shared Key] at this time, and an attempt to reconnect to the router is made.

### [Shared Key]

Uses an encryption key for the password.

- 3 Select [Edit Encryption Key] and press **OK**.
- 4 Select an encryption key that is not registered, and press **OK**.

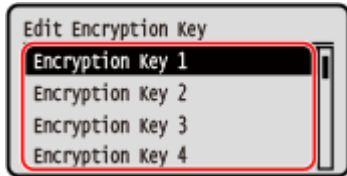

⇒ The encryption key input screen is displayed.

- 5 Enter the network key, select [<Apply>], and press **OK**.
 

⇒ The encryption key is registered to the [Encryption Key] screen.
- 6 Select [Select Encryption Key] and press **OK**.
- 7 Select a registered encryption key, and press **OK**.

## ■ When Using WPA-PSK or WPA2-PSK

- 1 Select [WPA/WPA2-PSK] and press **OK**.
 

⇒ The [WPA/WPA2 Encryption] screen is displayed.
- 2 Select the encryption method and press **OK**.
 

⇒ The encryption key input screen is displayed.

When you select [Auto], AES-CCMP or TKIP is set automatically according to the wireless LAN router to which you want to connect.

- 3 Enter the network key, select [<Apply>], and press **OK**.

## ■ When Using WPA-EAP or WPA2-EAP

Select [WPA/WPA2-EAP] and press **OK**.

## ■ When Not Using a Security Standard

Select [None] and press **OK**.

- 6 Select [Yes] and press **OK**.

- 7 When [Connected.] is displayed on the control panel, press **OK**.

⇒ When the machine is connected to the wireless LAN, [ ( ) ] appears on the [Home] screen.

- 8 Wait a few minutes.



- ➡ By default, an IP address is set automatically.  
To use a specific IP address, set this manually.

▶ **Setting IPv4 Addresses(P. 58)**

▶ **Setting IPv6 Addresses(P. 60)**

## NOTE

### If an Error Message Appears during Operation and a Connection Cannot Be Established

- Press **OK**, check the information of the wireless LAN router to which you want to connect, and repeat the procedure starting from Step 2.

# Setting IPv4 Addresses

The machine's IPv4 address can either be assigned automatically using DHCP or entered manually. By default, the IPv4 address is set automatically when connected to a wired or wireless LAN, but you can set it or change it manually according to your usage environment and purpose.

This section describes how to configure the settings using the control panel.

You can also set the IPv4 address using Remote UI from a computer after it has been set on the machine. [▶Managing the Machine from a Computer \(Remote UI\)\(P. 255\)](#)

Administrator privileges are required. The machine must be restarted to apply the settings.

**1** On the control panel, select [Menu] in the [Home] screen, and press **OK**. [▶\[Home\] Screen\(P. 94\)](#)

**2** Press [Preferences] ▶ **OK** ▶ [Network] ▶ **OK** ▶ [TCP/IP Settings] ▶ **OK** ▶ [IPv4 Settings] ▶ **OK** ▶ [IP Address Settings] ▶ **OK**.

If the login screen appears, enter the System Manager ID and PIN, and then press **ID**. [▶System Manager ID and PIN\(P. 6\)](#)

**3** Set the IP address.

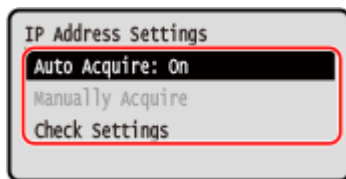

## ■ When Manually Setting the IP Address

**1** Select [Auto Acquire] and press **OK**.

⇒ The [Auto Acquire] screen is displayed.

**2** Press [Select Protocol] ▶ **OK** ▶ [Off] ▶ **OK**.

**3** Press [Auto IP] ▶ **OK** ▶ [Off] ▶ **OK**.

**4** Select [<Apply>] and press **OK**.

⇒ The [IP Address Settings] screen is displayed.

**5** Select [Manually Acquire] and press **OK**.

⇒ The IP address input screen is displayed.

**6** Enter the IP address and press **OK**.

**7** Enter the subnet mask and press **OK**.

**8** Enter the gateway address and press **OK**.

## ■ When Assigning an IP Address Automatically

**1** Select [Auto Acquire] and press **OK**.

⇒ The [Auto Acquire] screen is displayed.

## 2 Configure the Auto Acquire setting, as needed.

### [Select Protocol]

Normally, set to [DHCP]. However, when [DHCP] is set in an environment where DHCP cannot be used, the machine will continue to confirm Auto Acquire in the network, creating unnecessary communication. When not using DHCP, set this to [Off].

### [Auto IP]

Normally, set to [On]. Although priority is given to the IP address allocated with DHCP, if there is no response from DHCP, Auto IP will be used.

## 3 Select [<Apply>] and press **OK**.

## 4 Restart the machine. ▶ **Restarting the Machine(P. 87)**

⇒ The settings are applied.

Perform a connection test to check whether the IPv4 address is correctly configured. ▶ **Checking the Network Status and Settings(P. 76)**

## NOTE

### Checking the Currently Set IP Address

- On the screen in Step 3, select [Check Settings] and press **OK** to check the current IP address setting. If the IP address is displayed as "0.0.0.0," it is not correctly configured.

### If the IP Address Is Changed after Installing the Printer Driver

- In Windows, you must add a new port. ▶ **Configuring a Printer Port (Windows)(P. 141)**  
If you do not know which port is being used, see the following:  
▶ **Viewing the Printer Port(P. 477)**
- In macOS, you must re-register the machine on the Mac. For details about registering the machine, see the manual of the driver at the online manual site.  
**<https://oip.manual.canon/>**

\* If you are using DHCP to automatically obtain the IP address of the machine, the IP address may be changed automatically.

# Setting IPv6 Addresses

9664-01A

In an IPv6 environment, you can set the following IPv6 addresses and use them at the same time.

- **Link-Local Address**

An address that can only be used within the same link. It cannot be used to communicate with devices beyond a router.

A link-local address is automatically set when usage of IPv6 addresses is enabled.

- **Stateless Address**

An address that is generated automatically using the network prefix provided by the router and the MAC address of the machine.

This address is discarded when the machine is restarted or turned ON.

- **Manual Address**

An address that is entered manually by specifying the IP address, prefix length, and default router address.

- **Stateful Address**

An address obtained from a DHCP server using DHCPv6.

This section describes how to configure the settings using Remote UI from a computer.

On the control panel, select [Menu] in the [Home] screen, and then select [Preferences] to configure the settings. You cannot use the control panel to configure some of the settings. [▶\[IPv6 Settings\]\(P. 297\)](#)

Administrator privileges are required. The machine must be restarted to apply the settings.

## Required Preparations

- Set an IPv4 address to the machine. [▶Setting IPv4 Addresses\(P. 58\)](#)

**1 Log in to Remote UI in System Manager Mode.** [▶Starting Remote UI\(P. 256\)](#)

**2 On the Portal page of Remote UI, click [Settings/Registration].** [▶Portal Page of Remote UI\(P. 259\)](#)

**3 Click [Network Settings] ▶ [IPv6 Settings] ▶ [Edit].**

⇒ The [Edit IPv6 Settings] screen is displayed.

**4 In [IP Address Settings], select the [Use IPv6] checkbox.**

**5 Set the IPv6 address to use.**

■ **When Using a Stateless Address**

Select the [Use Stateless Address] checkbox.

■ **When Using a Manual Address**

Select the [Use Manual Address] checkbox, and enter the IP address, prefix length, and default router address.

\* You cannot enter a multicast address (address starting with "ff").

■ **When Using a Stateful Address**

Select the [Use DHCPv6] checkbox.

**6** Click [OK].

**7** Restart the machine. ▶ **Restarting the Machine(P. 87)**

⇒ The settings are applied.

Perform a connection test to check whether the IPv6 address is correctly configured. ▶ **Checking the Network Status and Settings(P. 76)**

## NOTE

### If the IP Address Is Changed after Installing the Printer Driver

- You must add a new port. ▶ **Adding a Port(P. 141)**

# Configuring Your Machine for Your Network Environment

---

9664-01C

The size and configuration of a network vary depending on the purpose and usage. The machine is equipped with a variety of technologies to support many environments.

Configure the settings of the machine according to your network environment, as needed.

▶ **Manually Configuring the Ethernet Settings(P. 63)**

▶ **Configuring DNS(P. 64)**

▶ **Configuring SMB(P. 67)**

▶ **Configuring WINS(P. 68)**

▶ **Configuring SNMP(P. 69)**

▶ **Configuring SNTP(P. 72)**

▶ **Configuring SLP Communication(P. 74)**

## ■ See Also

To reduce the threat of unauthorized access and eavesdropping, it is recommended to configure the security settings according to your network environment.

▶ **Protecting the Network(P. 202)**

## NOTE

### Using the Machine in a Network with IEEE 802.1X Authentication

- When connecting the machine to a network that uses IEEE 802.1X authentication, you must configure the settings on the machine such as the authentication method managed by the authentication server. ▶ **Using IEEE 802.1X(P. 215)**

# Manually Configuring the Ethernet Settings

---

9664-01E

By default, when the machine connects to a wired LAN, the Ethernet communication mode and Ethernet type are detected automatically, and these can be used without changes. Depending on the usage environment, you may have to change the Ethernet settings to suit the settings of peripheral devices.

This section describes how to configure the settings using Remote UI from a computer.

On the control panel, select [Menu] in the [Home] screen, and then select [Preferences] to configure the settings. ▶  
**[Ethernet Driver Settings](P. 290)**

Administrator privileges are required. The machine must be restarted to apply the settings.

## 1 Log in to Remote UI in System Manager Mode. ▶Starting Remote UI(P. 256)

## 2 On the Portal page of Remote UI, click [Settings/Registration]. ▶Portal Page of Remote UI(P. 259)

## 3 Click [Network Settings] ▶ [Ethernet Driver Settings] ▶ [Edit].

⇒ The [Edit Ethernet Driver Settings] screen is displayed.

## 4 Clear the [Auto Detect] checkbox.

## 5 Select the communication mode.

Normally, select [Full Duplex]. When the network router is set to half duplex communication, select [Half Duplex].

## 6 Select the Ethernet type, and click [OK].

## 7 Restart the machine. ▶Restarting the Machine(P. 87)

⇒ The settings are applied.

# Configuring DNS

9664-01F

When using the machine in an environment with Domain Name System (DNS), configure the DNS server information and DHCP option settings.

In an environment without DNS, you can configure multicast DNS (mDNS) to use the DNS function. mDNS is used by Bonjour and other software.

This section describes how to configure the settings using Remote UI from a computer.

On the control panel, select [Menu] in the [Home] screen, and then select [Preferences] to configure the settings. You cannot use the control panel to configure some of the settings. [▶\[TCP/IP Settings\]\(P. 295\)](#)

Administrator privileges are required. Depending on the item to be configured, you may have to restart the machine.

## Required Preparations

- When configuring DNS for IPv6, configure the setting to use an IPv6 address. [▶Setting IPv6 Addresses\(P. 60\)](#)

**1 Log in to Remote UI in System Manager Mode.** [▶Starting Remote UI\(P. 256\)](#)

**2 On the Portal page of Remote UI, click [Settings/Registration].** [▶Portal Page of Remote UI\(P. 259\)](#)

**3 Click [Network Settings] ▶ [IPv4 Settings] or [IPv6 Settings] ▶ [Edit].**

⇒ The [Edit IPv4 Settings] screen or [Edit IPv6 Settings] screen is displayed.

**4 In [DHCP Option Settings], configure the DHCP option settings.**

If you are not configuring the DHCP option settings, proceed to Step 5.

Select the checkboxes of the items to enable.

### **[Acquire Host Name] (IPv4 only)**

Obtains a host name (Option 12) from the DHCP server.

### **[DNS Dynamic Update] (IPv4 only)**

The DHCP server automatically updates the information (Option 81) corresponding to the host name in place of the machine.

### **[Acquire DNS Server Address]**

Obtains a DNS server address (Option 6 for IPv4, Option 23 for IPv6) from the DHCP server.

### **[Acquire Domain Name]**

Obtains a domain name (Option 15 for IPv4, Option 24 for IPv6) from the DHCP server.

### **[Acquire WINS Server Address] (IPv4 only)**

Obtains a WINS server address (Option 44) from the DHCP server.

### **[Acquire POP Server Address] (IPv4 only)**

Obtains a POP3 server address (Option 70) from the DHCP server.



## 5 In [DNS Settings], set the DNS server information.

- For details about the setting information, contact your provider or network administrator. You can also refer to the computer settings. [▶ Viewing the Network Connection Information of the Computer \(P. 475\)](#)
- If you are not configuring the DNS server information, proceed to Step 6.

### [Primary DNS Server Address]

Enter the IP address of the DNS server.

\* For IPv6, you cannot enter a multicast address (address starting with "ff").

### [Secondary DNS Server Address]

When using a secondary DNS server, enter the IP address of that server.

\* For IPv6, you cannot enter a multicast address (address starting with "ff").

### [Use Same Host Name/Domain Name as IPv4] (IPv6 only)

Select the checkbox to use the same host and domain names as in IPv4.

To set the IPv6 host name and domain name individually, clear this checkbox, and enter [Host Name] and [Domain Name].

### [Host Name]

Enter the host name to register in the DNS server using single-byte alphanumeric characters.

### [Domain Name]

Enter the domain name to which the machine belongs using single-byte alphanumeric characters.

**Input example:**

example.com

### [DNS Dynamic Update]

Select the checkbox to automatically update the DNS records when the corresponding information of the host name and IP address is changed in a DHCP environment, for example.

#### To Specify the Type of Address to Register to the DNS Server (IPv6 only)

Depending on the type of address you want to register, select the [Register Manual Address], [Register Stateful Address], or [Register Stateless Address] checkbox.

#### To Specify the Interval between Updates

In [DNS Dynamic Update Interval], enter the interval at which to automatically update this information.

## 6 In [mDNS Settings], configure the mDNS settings.

If you are not configuring the mDNS settings, proceed to Step 7.

### For IPv4

To use mDNS, select the [Use mDNS] checkbox, and enter the mDNS name.

### For IPv6

To use mDNS, select the [Use mDNS] checkbox, and select whether to use the same mDNS name as IPv4.

- To use the mDNS name set with IPv4 also with IPv6, select the [Use Same mDNS Name as IPv4] checkbox.
- To configure the mDNS name of IPv6 individually, clear the [Use Same mDNS Name as IPv4] checkbox, and enter the mDNS name.

## 7 Click [OK].

**8 Restart the machine. ▶ Restarting the Machine(P. 87)**

⇒ The settings are applied.

# Configuring SMB

9664-01H

The Server Message Block (SMB) communication protocol is used to enable the machine as a shared printer on the network. Depending on the network environment, you may have to set the computer name and workgroup name of the machine

## Setting the Computer Name and Workgroup Name

Set the computer name used to identify the machine in a network and the workgroup name to identify the group that the machine belongs to.

Configure these settings using Remote UI from a computer. You cannot use the control panel to configure the settings.

Administrator privileges are required. The machine must be restarted to apply the settings.

- 1 Log in to Remote UI in System Manager Mode.** ▶ **Starting Remote UI(P. 256)**
- 2 On the Portal page of Remote UI, click [Settings/Registration].** ▶ **Portal Page of Remote UI(P. 259)**
- 3 Click [Network Settings] ▶ [Computer Name/Workgroup Name Settings] ▶ [Edit].**

⇒ The [Edit Computer Name/Workgroup Name Settings] screen is displayed.

- 4 Enter the computer name and workgroup name of the machine, and click [OK].**

Enter using single-byte alphanumeric characters.

### ■ In an Environment with WINS

- Select the [Use NetBIOS] checkbox.
- You cannot register names that start with an asterisk (\*) to the WINS server.

- 5 Restart the machine.** ▶ **Restarting the Machine(P. 87)**

⇒ The settings are applied.

# Configuring WINS

9664-01J

When using the machine in a network environment that uses both NetBIOS and TCP/IP, configure Windows Internet Name Service (WINS) to convert the NetBIOS name to an IP address.  
To enable WINS, specify the WINS server. WINS cannot be used in an IPv6 environment.

This section describes how to configure the settings using Remote UI from a computer.  
On the control panel, select [Menu] in the [Home] screen, and then select [Preferences] to configure the settings. ▶  
**[WINS Settings](P. 298)**  
Administrator privileges are required. The machine must be restarted to apply the settings.

## Required Preparations

- Set the computer name and workgroup name. ▶ **Setting the Computer Name and Workgroup Name(P. 67)**
- Prepare the IPv4 address of the WINS server and keep it close by.

**1 Log in to Remote UI in System Manager Mode.** ▶ **Starting Remote UI(P. 256)**

**2 On the Portal page of Remote UI, click [Settings/Registration].** ▶ **Portal Page of Remote UI(P. 259)**

**3 Click [Network Settings] ▶ [WINS Settings] ▶ [Edit].**

⇒ The [Edit WINS Settings] screen is displayed.

**4 Select the [WINS Resolution] checkbox.**

**5 Enter the IPv4 address of the WINS server, and click [OK].**

If the IP address of the WINS server is obtained from a DHCP server, the obtained IP address has priority. ▶ **Configuring DNS(P. 64)**

**6 Restart the machine.** ▶ **Restarting the Machine(P. 87)**

⇒ The settings are applied.

# Configuring SNMP

9664-01K

Simple Network Management Protocol (SNMP) is a protocol for monitoring and controlling communication devices in a network by accessing a Management Information Base (MIB). Configure these settings according to the purpose of use and environment of the machine.

The machine supports SNMPv1 and SNMPv3. You can also use both at the same time. Trap notification is not supported.

When SNMP management software is installed on the network, you can use the software to configure, monitor, and control the machine remotely from a computer. For more information, see the manual of the software you are using.

## SNMPv1

SNMPv1 defines the scope of communication using information called a "community name." As the community name is sent to the network in plain text, the security of the network is vulnerable. To ensure network security, disable SNMPv1 and use SNMPv3. When SNMPv1 is disabled, you will not be able to use some functions such as obtaining information from the machine using the printer driver.

## SNMPv3

SNMPv3 communicates using user information for SNMPv3. This protocol enables you to configure the authentication and encryption in the user information to monitor and control communication devices on the network with a solid security system.

This section describes how to configure the settings using Remote UI from a computer.

On the control panel, select [Menu] in the [Home] screen, and then select [Preferences] to configure the settings.

However, the control panel can only be used to enable or disable SNMPv1 and SnMPv3. [▶\[SNMP Settings\]\(P. 289\)](#) Administrator privileges are required. The machine must be restarted to apply the settings.

### Required Preparations

- To configure SNMPv3, you must enable TLS. [▶Using TLS\(P. 209\)](#)

**1 Log in to Remote UI in System Manager Mode.** [▶Starting Remote UI\(P. 256\)](#)

**2 On the Portal page of Remote UI, click [Settings/Registration].** [▶Portal Page of Remote UI\(P. 259\)](#)

**3 Click [Network Settings] ▶ [SNMP Settings] ▶ [Edit].**

⇒ The [Edit SNMP Settings] screen is displayed.

**4 In [SNMPv1 Settings], set SNMPv1.**

### ■To Enable SNMPv1

**1** Select the [Use SNMPv1] checkbox.

**2** Configure the community.

- You can set MIB Access Permission (permission to read/write to MIB objects) for each community.
- When using both SNMPv1 and SNMPv3, it is recommended to set MIB Access Permission to [Read Only]. When setting SNMPv1 to [Read/Write] (full-access permission), you can perform nearly all operations, and therefore, you are not able to use the solid security features of SNMPv3.

**To Configure the Community Name**

Select the [Use Community Name 1] or [Use Community Name 2] checkbox, and configure the community name and MIB Access Permission.

Enter the community name using single-byte alphanumeric characters.

**To Configure a Dedicated Community**

Dedicated Community is a preset community for Canon Device Management software.

To use Dedicated Community, select the [Use Dedicated Community] checkbox, and configure MIB Access Permission.

\* For details, see the manual of the software you are using.

**■ To Disable SNMPv1**

Clear the [Use SNMPv1] checkbox.

**5 In [SNMPv3 Settings], configure SNMPv3.****■ To Enable SNMPv3**

- 1** Select the [Use SNMPv3] checkbox.
- 2** In [User Settings 1], [User Settings 2], or [User Settings 3], select the [Enable User] checkbox.
- 3** Configure the user.

**[User Name]**

Enter the user name using single-byte alphanumeric characters.

**[MIB Access Permission]**

Set the read/write permission to MIB objects for each specified user.

To allow both read and write, select [Read/Write].

**[Security Settings]**

Select whether to enable or disable authentication and encryption.

**[Authentication Algorithm]**

When [Authentication On/Encryption On] or [Authentication On/Encryption Off] is selected in [Security Settings], select the authentication algorithm according to the usage environment.

To set a password, select the [Set/Change Password] checkbox, and enter the same password in both [Authentication Password] and [Confirm] using single-byte alphanumeric characters.

**[Encryption Algorithm]**

When [Authentication On/Encryption On] is selected in [Security Settings], select the encryption algorithm according to the usage environment.

To set a password, select the [Set/Change Password] checkbox, and enter the same password in both [Encryption Password] and [Confirm] using single-byte alphanumeric characters.

**■ To Disable SNMPv3**

Clear the [Use SNMPv3] checkbox.

**6 In [Printer Management Information Acquisition Settings], select whether to obtain the printer management information.**

To regularly obtain printer management information from the machine, such as protocols and ports, select the [Acquire Printer Management Information from Host] checkbox.

**7 Click [OK].**

**8 Restart the machine. ▶Restarting the Machine(P. 87)**

⇒ The settings are applied.

## NOTE

### Changing the Port Number

- To change the port number of the SNMP server, see the following:  
▶**Changing the Port Number(P. 206)**

## Configuring SNTP

9664-01L

To obtain time information from the time server on the network, configure Simple Network Time Protocol (SNTP). When SNTP is configured, the time server is checked at specified intervals to adjust the time and maintain the correct time on the machine.

The machine supports both an NTP server (NTPv3) and SNTP server (SNTPv3 and v4).

Configure these settings using Remote UI from a computer. You cannot use the control panel to configure the settings.

Administrator privileges are required. The machine must be restarted to apply the settings.

### Required Preparations

- The time is adjusted based on the UTC (Coordinated Universal Time), so specify the time zone setting. [▶ Setting the Date and Time\(P. 254\)](#)
- Prepare the IP address of the NTP or SNTP server and keep it close by.

**1 Log in to Remote UI in System Manager Mode.** [▶ Starting Remote UI\(P. 256\)](#)

**2 On the Portal page of Remote UI, click [Settings/Registration].** [▶ Portal Page of Remote UI\(P. 259\)](#)

**3 Click [Network Settings] ▶ [SNTP Settings] ▶ [Edit].**

⇒ The [Edit SNTP Settings] screen is displayed.

**4 Select the [Use SNTP] checkbox.**

**5 In [NTP Server Name], enter the IP address of the NTP/SNTP server.**

When using a DNS server, you can enter the host name or FQDN instead of the IP address.

**Input example:**  
ntp.example.com

**6 In [Polling Interval], enter the interval at which to check the server and adjust the time.**

**7 Click [OK].**

**8 Restart the machine.** [▶ Restarting the Machine\(P. 87\)](#)

⇒ The settings are applied.

## NOTE



## Testing Communication with the NTP or SNTP Server

- Test communication using the following procedure: If the machine is correctly communicating with the server, [OK] appears in [NTP Server Check Result].

Log in to Remote UI in System Manager Mode ▶ click [Settings/Registration] ▶ [Network Settings] ▶ [SNTP Settings] ▶ [Check NTP Server].

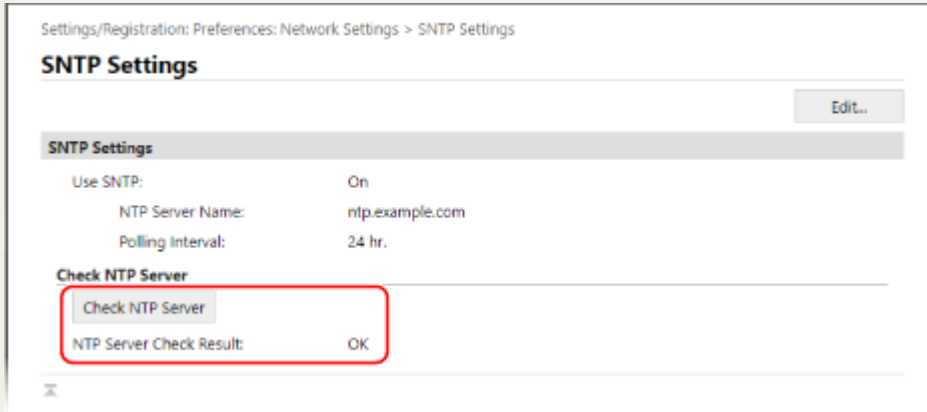

\* This tests the communication status and does not adjust the time.

# Configuring SLP Communication

When using the machine in an environment using a Service Location Protocol (SLP) with software installed to perform communication, configure the SLP communication settings, as needed.

\* See the manual of the software to determine the settings that need to be configured.

Configure these settings using Remote UI from a computer. You cannot use the control panel to configure the settings.

Administrator privileges are required. The machine must be restarted to apply the settings.

## Required Preparations

- Prepare the port number used for SLP communication with the software and keep it close by.
- Check the number of routers the SLP communication packets will traverse.

**1 Log in to Remote UI in System Manager Mode.** ▶ **Starting Remote UI(P. 256)**

**2 On the Portal page of Remote UI, click [Settings/Registration].** ▶ **Portal Page of Remote UI(P. 259)**

**3 Click [Network Settings] ▶ [Multicast Discovery Settings] ▶ [Edit].**

⇒ The [Edit Multicast Discovery Settings] screen is displayed.

**4 Select the [Respond to Discovery] checkbox, enter the scope name, and click [OK].**

For the scope name, enter the name of the scope to which the machine belongs using single-byte alphanumeric characters.

**5 Click [Network Settings] ▶ [Sleep Mode Notification Settings] ▶ [Edit].**

⇒ The [Edit Sleep Mode Notification Settings] screen is displayed.

**6 Select the [Notify] checkbox.**

A notification of the power status of the machine is sent to the software. This helps reduce unneeded communication during sleep mode and power consumption.

**7 Configuring Sleep Mode Notifications**

### [Port Number]

Enter the port number used for SLP communication with the software.

### [Number of Routers to Traverse]

Enter the maximum number of routers that SLP communication packets can traverse.

### [Notification Interval]

Enter the interval at which notifications are sent about the power status of the machine.

**8** Click [OK].

**9** Restart the machine. ▶ [Restarting the Machine\(P. 87\)](#)

▣▣▣ The settings are applied.

## Checking the Network Status and Settings

9664-01S

You can perform a connection test with devices in the network to check whether the machine is correctly connected to the network.

The IP address of the machine and the MAC address information are needed to use Remote UI and configure the firewall settings. Check these current settings.

- ▶ **Checking Whether the Machine Can Connect to Network Devices(P. 76)**
- ▶ **Viewing the IP address set to the machine(P. 77)**
- ▶ **Viewing the MAC Address of the Wired LAN(P. 77)**
- ▶ **Viewing the MAC Address and Connection Information of the Wireless LAN(P. 78)**

### NOTE

- If the IP address is displayed as "0.0.0.0," it is not correctly configured. Set the IP address again.
  - ▶ **Setting IPv4 Addresses(P. 58)**
  - ▶ **Setting IPv6 Addresses(P. 60)**
- Connecting the machine to a switching hub, for example, may prevent connection to the network even when the IP address is correctly configured. In this case, set a wait time until machine starts communicating and try connecting again. ▶ **[Waiting Time for Connection at Startup](P. 290)**
- You can print the System Manager Data List to view the network settings. ▶ **Printing and Viewing Reports and Lists(P. 265)**

### Checking Whether the Machine Can Connect to Network Devices

In the Web browser of the computer connected to the network, enter the IPv4 or IPv6 address of the machine. If the Remote UI login screen is displayed, the machine is properly connected to the network. ▶ **Starting Remote UI(P. 256)**

When using an IPv4 address, you can use the following procedure to send a ping command from the control panel to check whether the machine can connect to a network device.

#### Required Preparations

- Prepare the IPv4 address of a device in the network to which you want to connect and keep it close by.

**1** On the control panel, select [Menu] in the [Home] screen, and press **OK**. ▶ **[Home] Screen(P. 94)**

**2** Press [Preferences] ▶ **OK** ▶ [Network] ▶ **OK** ▶ [TCP/IP Settings] ▶ **OK** ▶ [IPv4 Settings] ▶ **OK** ▶ [PING Command] ▶ **OK**.

If the login screen appears, enter the System Manager ID and PIN, and then press **ID**. ▶ **System Manager ID and PIN(P. 6)**

**3** Enter the IPv4 address of a network device, and press **OK**.

⇒ If the machine is correctly connected to the network, [Received response from host.] appears.

## Viewing the IP address set to the machine

You can view the setting of IP address set to the machine such as the IPv4 address and the IPv6 address.

This section describes how to view the IP address using the control panel.

You can also check this information using Remote UI from a computer. [▶Managing the Machine from a Computer \(Remote UI\)\(P. 255\)](#)

### 1 Press on the control panel.

⇒ The [Status Monitor] screen is displayed.

### 2 Press [Network Information] ▶ ▶ [IPv4] or [IPv6] ▶ .

### 3 View the setting and press .

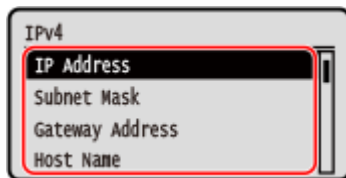

## Viewing the MAC Address of the Wired LAN

You can view the MAC address set to the machine when the machine is connected to the wired LAN.

This section describes how to view this information using the control panel.

You can also use Remote UI from a computer to view the MAC address. [▶Managing the Machine from a Computer \(Remote UI\)\(P. 255\)](#)

Administrator privileges are required.

### 1 On the control panel, select [Menu] in the [Home] screen, and press . ▶[Home] Screen(P. 94)

### 2 Press [Preferences] ▶ ▶ [Network] ▶ ▶ [Ethernet Driver Settings] ▶ .

If the login screen appears, enter the System Manager ID and PIN, and then press . ▶[System Manager ID and PIN\(P. 6\)](#)

### 3 View the MAC address.

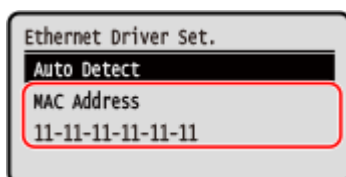

## Viewing the MAC Address and Connection Information of the Wireless LAN

In addition to the MAC address and connection information of the wireless LAN when the machine is connected to the wireless LAN, you can also view the security settings.

This section describes how to view this information using the control panel.

You can also check this information using Remote UI from a computer. ▶ **Managing the Machine from a Computer (Remote UI)(P. 255)**

Administrator privileges are required.

### 1 On the control panel, select [Wireless LAN Set.] in the [Home] screen and press **OK**. ▶ **[Home] Screen(P. 94)**

⇒ The [Select Network] screen is displayed.

If the login screen appears, enter the System Manager ID and PIN, and then press **ID**. ▶ **System Manager ID and PIN(P. 6)**

### 2 Press [Connection Settings] ▶ **OK** ▶ [Connection Information] ▶ **OK**.

### 3 View the MAC address and the settings.

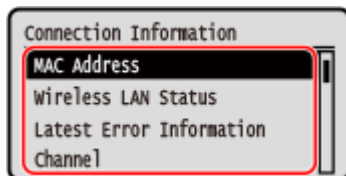

- Select [Latest Error Information] and press **OK** to display error information related to the wireless LAN connection.
- Select [Security Settings] and press **OK** to display the WEP or WPA/WPA2-PSK details.

## NOTE

### Viewing Information with the [Status Monitor] Screen

- You can also view the wireless LAN status and error information with the following procedure:

 on the control panel ▶ [Network Information] ▶ **OK** ▶ [Network Connection Method] ▶ **OK** ▶ [Connection Information] ▶ **OK**.

# Installing Software and Drivers to the Computer

9664-01U

Install the related software and drivers to the computer that will use the functions of the machine.  
Install any options to the machine before installing the software and drivers.

## Installation Procedure

Check the operating environment via the Canon website for your country/region, and download and install the latest software and drivers.

<https://global.canon/en/support/>

\* If the machine is supplied with a CD-ROM or DVD-ROM, you can also use this to install the software and drivers.

For details about the installation method, see the manual of the software or driver at the online manual site.

<https://oip.manual.canon/>

## Precautions and Limitations

### Operating Environment

- Depending on the operating system, your computer may not support some software or drivers. For the latest information on the supported operating systems, see the Canon website.

<https://global.canon/en/support/>

- Depending on the model and usage environment, some functions of the software or drivers may not be available.

### When the Firewall Settings of the Machine Are Configured

The computer that will be used with the machine must be allowed to communicate with the machine. If the computer is not allowed to communicate with the machine, you will not be able to install the software and drivers or use the functions of the machine. [▶Setting the Firewall\(P. 203\)](#)

### If the IP Address of the Machine Is Changed after Installing the Printer Driver

- In Windows, you must add a new port. [▶Configuring a Printer Port \(Windows\)\(P. 141\)](#)

If you do not know which port is being used, see the following:

#### ▶Viewing the Printer Port(P. 477)

- In macOS, you must re-register the machine on the Mac. For details about registering the machine, see the manual of the driver at the online manual site.

<https://oip.manual.canon/>

\* If you are using DHCP to automatically obtain the IP address of the machine, the IP address may be changed automatically.

## NOTE

### Using the Functions of the Machine without Installing Software or Drivers (macOS)

- You can use AirPrint standard equipped in macOS to print data from a computer without installing software or drivers. [▶Using AirPrint Application to Print Data\(P. 183\)](#)

# Basic Operations

<b>Basic Operations</b> .....	81
<b>Turning ON and OFF the Machine</b> .....	82
Turning ON the Machine .....	83
Turning OFF the Machine .....	84
Restarting the Machine .....	87
<b>Reducing Power Consumption (Sleep Mode)</b> .....	89
<b>Using the Control Panel</b> .....	91
Screens Displayed on the Control Panel .....	92
[Home] Screen .....	94
[Status Monitor] Screen .....	95
How to Operate the Control Panel .....	97
Entering Characters .....	99
Customizing the [Home] Screen .....	102
<b>Logging In to the Machine</b> .....	103
<b>Loading Paper</b> .....	104
Loading Paper in the Paper Drawer .....	105
Loading Paper in the Multi-purpose Tray .....	110
Preparations and Orientation for Loading Envelopes .....	113
Orientation for Loading Paper with a Logo .....	115
Specifying the Paper Size and Type .....	119
Setting the Paper Size and Type for the Paper Drawer .....	120
Setting the Paper Size and Type for the Multi-purpose Tray .....	122
Registering a Frequently Used Paper Size and Type for the Multi-purpose Tray .....	124
Registering Non-standard Size Paper (Custom Paper) .....	126
Hiding Unused Paper Sizes .....	127
Using the Appropriate Paper Source for Each Function .....	128
<b>Inserting and Removing a USB Memory Device</b> .....	129
<b>Adjusting the Sound Volume</b> .....	131
Adjusting the Volume .....	132
[Volume Settings] Screen .....	133



# Basic Operations

---

9664-01W

This chapter describes the basic operations common to all functions of the machine and how to understand the screen layout.

## Managing and Saving Power

You can turn OFF the power to conserve energy or when cleaning and restart the machine to apply the settings.

You can use sleep mode to reduce power consumption.

- ▶ **Turning ON and OFF the Machine(P. 82)**
- ▶ **Reducing Power Consumption (Sleep Mode)(P. 89)**

## Using the Operational Panel

Use the control panel to perform the functions such as Secure Print, and to configure the settings of the machine.

- ▶ **Using the Control Panel(P. 91)**

When the login screen is displayed, enter the required login information to continue operations.

- ▶ **Logging In to the Machine(P. 103)**

## Loading Paper

Load printing paper into the paper drawer or multi-purpose tray according to your usage.

- ▶ **Loading Paper(P. 104)**

## Using a USB Memory Device

When exchanging data between a USB memory device and the machine, handle the device properly to prevent damage to the device and errors.

- ▶ **Inserting and Removing a USB Memory Device(P. 129)**

## Adjusting the Sound Volume

You can set whether the machine emits sounds notifying you of operations and statuses.

- ▶ **Adjusting the Volume(P. 132)**

## Turning ON and OFF the Machine

---

9664-01X

Be sure to use the power switch to manually turn ON the power of the machine.

In addition to using the power switch, you can turn OFF the power and restart the machine using Remote UI from a computer.

You can also configure the machine to turn OFF automatically on days and times when not in use.

▶ **Turning ON the Machine(P. 83)**

▶ **Turning OFF the Machine(P. 84)**

▶ **Restarting the Machine(P. 87)**

## Turning ON the Machine

9664-01Y

To turn ON the machine, press the power switch on the front.

**1** Make sure that the power plug is inserted into a power outlet.

**2** Press the power switch.



⇒ The start screen is displayed on the control panel.

### NOTE

#### Changing the Screen that Appears at Startup

- After the power is turned ON and the start screen is displayed, the [Home] screen is displayed by default. You can configure the setting to display another function screen. **▶ [Default Screen after Startup/Restoration](P. 280)**

## Turning OFF the Machine

9664-020

In addition to using the power switch on the front of the machine, you can also turn OFF the power using Remote UI from a remote location. You can also configure the machine to turn OFF automatically on days and times when not in use.

Turning OFF the machine deletes any data waiting to be printed.

- ▶ **Turning OFF the Machine Using the Power Switch(P. 84)**
- ▶ **Turning OFF the Machine Using Remote UI(P. 84)**
- ▶ **Setting the Days of the Week and Time to Automatically Turn Off the Machine(P. 85)**

### NOTE

- The received data saved in the memory remains stored without being deleted even if the machine is turned OFF.

### Turning OFF the Machine Using the Power Switch

- 1 Press the power switch.**



- ▶ The control panel turns off, and the power turns OFF.  
It may take a few minutes until the power turns OFF. Do not unplug the power cord until the power turns OFF.

### NOTE

#### Turning ON the Machine Again

- Wait at least 10 seconds after turning OFF the power before turning ON the machine.

### Turning OFF the Machine Using Remote UI

Administrator privileges are required to turn OFF the machine using Remote UI.

- 1 Log in to Remote UI in System Manager Mode. ▶ Starting Remote UI(P. 256)**
- 2 On the Portal page of Remote UI, click [Settings/Registration]. ▶ Portal Page of Remote UI(P. 259)**
- 3 Click [Device Management] ▶ [Remote Shutdown].**

⇒ The [Remote Shutdown] screen is displayed.

#### 4 In [Device Status], check that there are no functions operating, and then click [Execute].

⇒ The shutdown confirmation message appears.

#### 5 Click [OK].

⇒ A screen indicating that the machine is being shut down is displayed, and then the power is turned OFF. When the power is turned OFF, Remote UI is disconnected.

## Setting the Days of the Week and Time to Automatically Turn Off the Machine

Configure these settings using Remote UI from a computer. You cannot use the control panel to configure the settings. Administrator privileges are required.

#### 1 Log in to Remote UI in System Manager Mode. ▶ Starting Remote UI(P. 256)

#### 2 On the Portal page of Remote UI, click [Settings/Registration]. ▶ Portal Page of Remote UI(P. 259)

#### 3 Click [Timer Settings] ▶ [Edit].

⇒ The [Edit Timer Settings] screen is displayed.

#### 4 Select the [Set Auto Shutdown Weekly Timer] checkbox.

#### 5 Enter a time for each day of the week you want to turn OFF the machine.

The screenshot shows the 'Set Time' configuration interface. At the top, there is a 'Set Time' label and a dropdown menu set to 'After 4 hours'. Below this, the 'Set Auto Shutdown Weekly Timer' checkbox is checked. The main area contains seven rows, one for each day of the week: Sunday, Monday, Tuesday, Wednesday, Thursday, Friday, and Saturday. Each row has two input fields for the time (hours and minutes) and a dropdown menu for the period (AM or PM). A red rectangular box highlights these input fields for all days. At the bottom of the form, there is an 'Auto Sleep Time' field with the value '1' and the unit 'min. (1-60)', and a checkbox labeled 'Use Auto Sleep Daily Timer' which is currently unchecked.

If you selected 12-hour format for the time display, select [AM] or [PM] after entering the time.

#### 6 Click [OK].

⇒ The settings are applied.

## 7 Log out from Remote UI.

### NOTE

#### Cases When the Power Will Not Turn OFF at a Specified Time

- In the following cases, the power of the machine will not turn OFF at the specified time:
  - When the data indicator on the control panel is lit or blinking **▶Control Panel(P. 14)**
  - When the [Menu] screen or Check Counter screen is displayed on the control panel
  - When importing or exporting data
  - When updating the firmware
- One minute after the specified time, the power will turn OFF or the operation will be retried. The machine will retry to power OFF up to 10 times at 1-minute intervals. If the machine does not power OFF, the power will remain ON for that day.

## Restarting the Machine

9664-021

When you make changes to the settings of the machine, you may have to restart the machine to apply the changes depending on the setting.

When you change the settings using either the control panel or Remote UI, you can restart the machine using the power switch or Remote UI.

Restarting the machine deletes any data waiting to be printed.

▶ **Restarting the Machine Using the Power Switch(P. 87)**

▶ **Restarting the Machine Using Remote UI(P. 87)**

### NOTE

- The received data saved in the memory remains stored without being deleted even if the machine is restarted.

### Restarting the Machine Using the Power Switch

#### 1 Press the power switch.

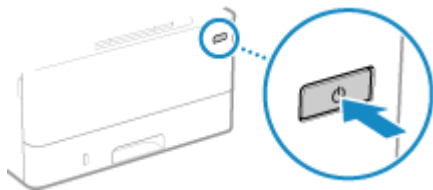

- ⇒ The control panel turns off, and the power turns OFF.  
It may take a few minutes until the power turns OFF.

#### 2 Wait at least 10 seconds after turning OFF the power before pressing the power switch.

- ⇒ The machine starts up.

### Restarting the Machine Using Remote UI

Administrator privileges are required to restart the machine using Remote UI.

#### 1 Log in to Remote UI in System Manager Mode. ▶ Starting Remote UI(P. 256)

#### 2 On the Portal page of Remote UI, click [Settings/Registration]. ▶ Portal Page of Remote UI(P. 259)

#### 3 Click [Restart Device].

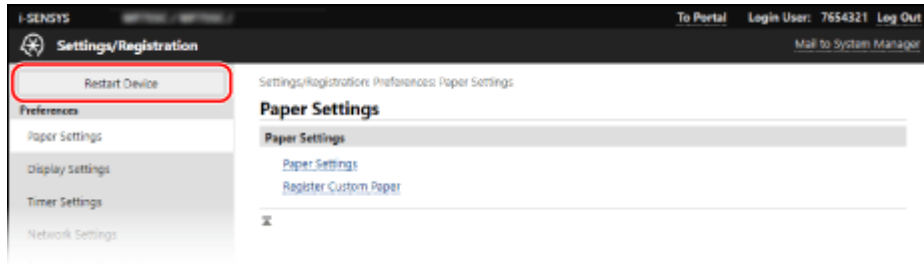

⇒ The [Restart Device] screen is displayed.

**4 In [Device Status], check that there are no functions operating, and then click [Execute].**

⇒ A restart confirmation message appears.

**5 Click [OK].**

⇒ A screen indicating that the machine is being restarted is displayed, and then the machine is restarted. When the machine is restarted, Remote UI is disconnected.



## Reducing Power Consumption (Sleep Mode)

9664-022

Sleep mode reduces power consumption by pausing certain operations inside the machine.

On the control panel, press [] to enter sleep mode. [▶Control Panel\(P. 14\)](#)

When the machine is in sleep mode,  lights yellow-green.

### ■ Exiting Sleep Mode

Perform any of the following operations:

- Press any key on the control panel.
- Tap the display.

### ■ Configuring Auto Sleep Time

Auto Sleep Time automatically places the machine into sleep mode if no operations are performed after a certain period of time or at a specified time. In addition to being able to set the time when the machine enters sleep mode, you can also configure the machine to exit sleep mode at a specified time.

This section describes how to configure the settings using Remote UI from a computer.

On the control panel, select [Menu] in the [Home] screen, and then select [Preferences] to configure the settings. [▶\[Timer/Energy Settings\]\(P. 284\)](#)

#### 1 Log in to Remote UI. [▶Starting Remote UI\(P. 256\)](#)

#### 2 On the Portal page of Remote UI, click [Settings/Registration]. [▶Portal Page of Remote UI\(P. 259\)](#)

#### 3 Click [Timer Settings] ▶ [Edit].

⇒ The [Edit Timer Settings] screen is displayed.

#### 4 Set Auto Sleep Time or the time to exit sleep mode.

##### ■ When Setting the Time until Sleep Mode

Enter the time in [Set Time].

\* It is recommended to use the default setting to efficiently save power. [▶\[Auto Sleep Time\]\(P. 286\)](#)

##### ■ When Entering Sleep Mode at a Specified Time

Select the [Use Auto Sleep Daily Timer] checkbox, and enter a time.

If you selected 12-hour format for the time display, select [AM] or [PM] after entering the time.

##### ■ When Exiting Sleep Mode at a Specified Time

Select the [Use Sleep Mode Exit Time Settings] checkbox, and enter a time.

If you selected 12-hour format for the time display, select [AM] or [PM] after entering the time.

#### 5 Click [OK].

⇒ The settings are applied.

## 6 Log out from Remote UI.

### NOTE

- The machine does not enter sleep mode in the following cases:
  - When the data indicator on the control panel is lit or blinking  **Control Panel(P. 14)**
  - When the [Menu] screen, a paper jam or other error message<sup>\*1</sup>, or Direct Connection SSID or network key display screen is displayed on the control panel
  - When the machine is performing an adjustment, cleaning, or other operation
  - When the machine is importing, exporting, or processing data via an external device, such as a USB memory device or computer

<sup>\*1</sup> The machine may enter sleep mode depending on the message.

# Using the Control Panel

---

9664-023

Use the control panel to change the settings of the machine and use the functions such as Secure Print.

## **Main Instructions**

Check how to use the buttons and items displayed on the control panel, how to enter text, and how to display the various screens.

▶ **Screens Displayed on the Control Panel(P. 92)**

▶ **How to Operate the Control Panel(P. 97)**

▶ **Entering Characters(P. 99)**

## **Making the [Home] Screen Easier to Use**

You can add shortcut buttons for frequently used functions and rearrange the buttons.

▶ **Customizing the [Home] Screen(P. 102)**

## Screens Displayed on the Control Panel

9664-024

The following are the main screens of the control panel.

### [Home] Screen

This screen is displayed when you press [] on the control panel. By default, the [Home] screen is displayed after the power is turned ON and immediately after the startup screen closes, and immediately after logging in.

▶ **[Home] Screen(P. 94)**

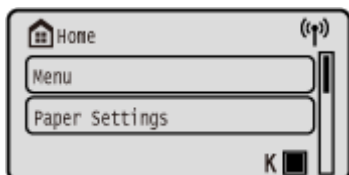

### [Status Monitor] Screen

This screen is displayed when you press [] on the control panel. Use this screen to check the information of the machine, usage and logs, network settings, and error information. ▶ **[Status Monitor] Screen(P. 95)**

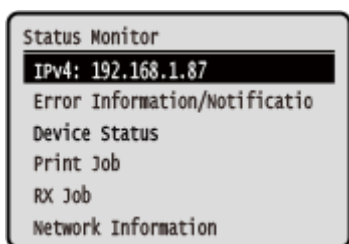

### [Menu] Screen

This screen is displayed when you press [Menu] on the [Home] screen. Use this screen to configure the various settings of the machine.

When the System Manager ID is set, the login screen may be displayed when certain items are selected. Only users who know the System Manager ID and PIN can log in and change the settings.

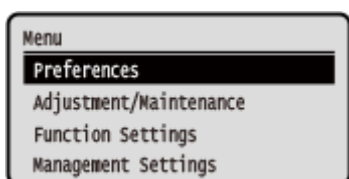

### Message Display

Messages are displayed on the screen when errors occur and the machine is out of paper or toner in the toner cartridge.

If a troubleshooting solution is displayed, follow the on-screen instructions to solve the problem.

If a troubleshooting solution is not displayed, check the cause and solution by referring to the message or error code.

▶ **A Message Appears(P. 445)**

▶ **An Error Code Is Displayed(P. 458)**

#### Display example:

- **When an Error Occurs**

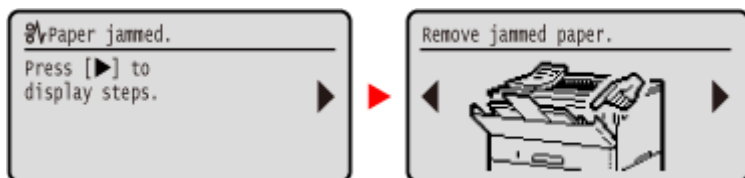

- **When a Message Appears on the Screen**

If the message is too long to display at once, it may be separated into smaller segments and displayed alternately.

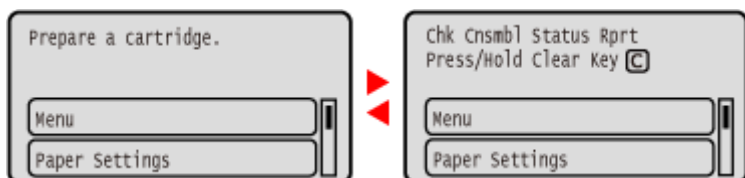

## NOTE

### Changing the Screen Display

- You can change the control panel display such as by changing the display language and units, and show or hide messages. ▶ **[Display Settings](P. 280)**
- You can invert screen colors and adjust the brightness to make the screen easier to view. ▶ **[Accessibility] (P. 303)**

### Clearing the Settings Automatically

- By default, if no operations are performed after a certain period of time, the settings being configured on the screen are cleared, and the [Home] screen is displayed. You can change the time until the settings are cleared and the screen that is displayed after.
  - ▶ **[Auto Reset Time](P. 285)**
  - ▶ **[Function After Auto Reset](P. 285)**

## [Home] Screen

9664-025

This screen is displayed when you press [] on the control panel.

The status of the machine is displayed at the top and bottom of the screen for quick viewing and operations, as needed.

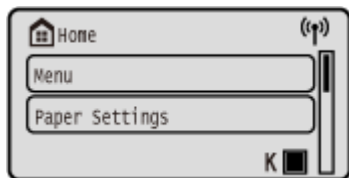

### ■ Status of the Machine

[]

When connected to a wireless LAN, [] is displayed.

[]

Displays the remaining amount of toner in the toner cartridge.

### ■ Function and Setting Buttons

**[Menu]**

Configure the various settings of the machine. [▶Settings Menu Items\(P. 277\)](#)

**[Paper Settings]**

Set the paper size and type to use, and register frequently used paper. [▶Specifying the Paper Size and Type\(P. 119\)](#)

**[Secure Print]**

Prints data temporarily saved in the memory of the machine. [▶Printing a Document Secured with a PIN \(Secure Print\)\(P. 159\)](#)

**[Mobile Portal]**

Connect mobile devices to the machine. [▶Connecting a Mobile Device to the Machine\(P. 178\)](#)

**[Display Order (Home)]**

You can change the display order of the items on the [Home] screen. [▶Customizing the \[Home\] Screen\(P. 102\)](#)

**[Wireless LAN Set.]**

Connects a computer to the machine via a wireless LAN router (access point). [▶Connecting to a Wireless LAN by Searching for a Router \(Access Point Setup Method\)\(P. 53\)](#)

**[Update Firmware]**

Updates the firmware via the Internet. [▶Updating the Firmware\(P. 270\)](#)

## [Status Monitor] Screen

9664-026

This screen is displayed when you press  on the control panel.

Use this screen to check the information of the machine, usage and logs, network settings, and error information. You can also use this screen to remove USB memory devices from the machine.

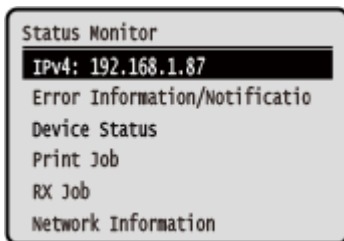

### [IPv4]

Displays the IPv4 address of the machine by default. You can also hide this. ▶[\[Display IP Address\]\(P. 283\)](#)

### [Error Information/Notification]

You can check the information of errors that occur on the machine. Take troubleshooting measures according to the error details.

▶[A Message Appears\(P. 445\)](#)

▶[An Error Code Is Displayed\(P. 458\)](#)

### [Device Status]

#### [Paper Information]

Check the remaining amount of paper for each paper source.

#### [Cartridge Level]

Check the remaining amount of toner in the toner cartridge.

Other internal parts may reach the end of their lifetime before the toner runs out.

#### [Check Toner Cartridge Name]

Check the toner cartridge name.

#### [Remove Memory Media]

Displayed when a USB memory device is connected. Press to remove the USB memory device. ▶[Removing the USB Memory Device\(P. 130\)](#)

#### [Check Counter]

Check the total number of printed pages. ▶[Checking the Number of Printed Pages \(Check Counter\)\(P. 264\)](#)

#### [Secure Print Memory Usage]

Check to see how much memory is used by the Secure Print data temporarily saved to the memory of the machine.

#### [Version Information]

Displays the firmware version information of the machine.

#### [Serial Number]

Displays the serial number of the machine.

### [Print Job]

Displays the print processing status and log. ▶[Viewing the Print Job Status and Log\(P. 169\)](#)

### [RX Job]

Displays the status and log of received I-Faxes.

**[Network Information]**

**[IPv4]**

Check the IPv4 address and other settings. ▶ **Setting IPv4 Addresses(P. 58)**

**[IPv6]**

Check the IPv6 address and other settings. ▶ **Setting IPv6 Addresses(P. 60)**

**[Network Connection Method]**

Check whether the machine has a wired or wireless connection.

Displays the connection status and error information when connected by wireless LAN.

**[Direct Connection Information]**

Displays the connection status when directly connected to a device.

**[IEEE 802.1X Error Information]**

Displays the details of errors that occur with IEEE 802.1X authentication.



# How to Operate the Control Panel

9664-027

Use the keys on the control panel to set the various functions and check the settings.

- ▶ **Scrolling the Screen(P. 97)**
- ▶ **Moving to the Next or Previous Screen(P. 97)**
- ▶ **Confirming a Selected Item(P. 97)**
- ▶ **Using the Slider to Set Values(P. 97)**

## Scrolling the Screen

When the scroll bar appears on the screen, it indicates that there are items or information that cannot be completely displayed on the screen. Use ▲ or ▼ to scroll the screen in the direction pressed. The currently selected item is inverted.

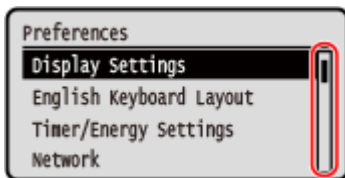

## Moving to the Next or Previous Screen

To move to the next screen, press **OK** or ▶. To return to the previous screen, press ◀ or **↶**.



## Confirming a Selected Item

To confirm a selected item, press **OK**.

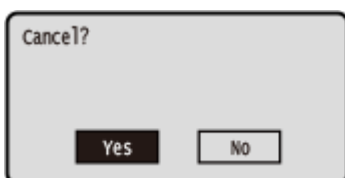

## Using the Slider to Set Values

To adjust the value, press ◀ or ▶.

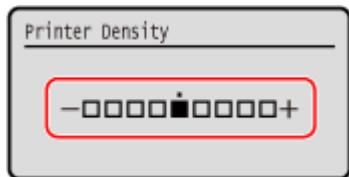

# Entering Characters

Enter alphanumeric characters using the numeric keys on the control panel.  
You can also enter characters using a commercial USB keyboard connected to the machine.

- ▶ **Entering Characters Using the Control Panel(P. 99)**
- ▶ **Entering Characters Using a USB Keyboard(P. 100)**

## Entering Characters Using the Control Panel

You can enter letters, numbers, and symbols using the control panel.  
The type of characters that you can enter may be limited depending on the item.  
If the value input range is limited, the value that you can enter is displayed in parentheses ( ) on the screen.

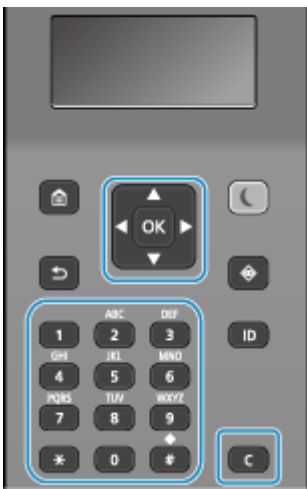

### Changing the Character Type

Press **\*** to change the character type in the order of uppercase letters (A), lowercase letters (a), and numbers (12).

You can also press [Entry Mode] ▶ **OK** to select the character type.

You cannot change the character type for items whose character type is limited.

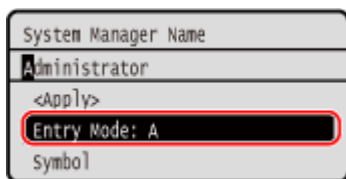

### Entering Characters, Spaces, and Symbols

Enter characters and symbols using the numeric keys. The following are the usable keys and characters that can be entered:

You can enter a space by moving the cursor to the end of the characters and pressing ▶.

When [Entry Mode] is set to [aA] and you press **#**, symbols are displayed.

Key	A	a	12
<b>1</b>	@ . - _ /		1
<b>2</b>	ABC	abc	2
<b>3</b>	DEF	def	3
<b>4</b>	GHI	ghi	4

Key	A	a	12
<b>5</b>	JKL	jkl	5
<b>6</b>	MNO	mno	6
<b>7</b>	PQRS	pqrs	7
<b>8</b>	TUV	tuv	8
<b>9</b>	WXYZ	wxyz	9
<b>0</b>	(Not available)		0
<b>#</b>	(space) -. * # ! " ; : ^ ` _ = /   ' ? \$ @ % & + \ ~ ( ) [ ] { } < >		(Not available)

**Deleting Characters**

Press **C** to delete one character.

Press and hold **C** to continuously delete characters.

**Moving the Cursor**

Press **◀** or **▶**.

**Entering Numbers**

Press **▲** or **▼**. You can also use the numeric keys to enter numbers when  is displayed on the screen.

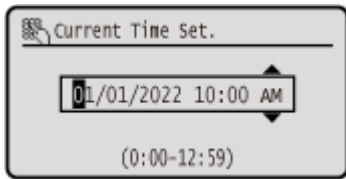

**NOTE**

- When the slider is displayed, press **◀** or **▶** to set the value. [▶ Using the Slider to Set Values\(P. 97\)](#)

**Entering Characters Using a USB Keyboard**

You can enter characters in the same way as a computer by connecting a commercial USB keyboard to the USB port on the back of the machine. [▶ Rear Side\(P. 12\)](#)

\* You can still enter characters using the control panel when a USB keyboard is connected to the machine.

The connected USB keyboard can be disconnected from the machine at anytime. You do not need to cancel the connection first.

**! IMPORTANT**

- [Backspace], [Home], [End], and other keys may not be usable. Pressing an unusable key does not enter a character.
- Depending on the display language, some characters may not be entered correctly.
- Depending on the type of USB keyboard, it may not operate properly.

**NOTE**

- You can specify the USB keyboard layout (US layout or UK layout). ▶[\[English Keyboard Layout\]\(P. 278\)](#)

## Customizing the [Home] Screen

9664-029

You can quickly select frequently used functions from the [Home] screen of the control panel.  
You can rearrange the items on the [Home] screen.

- 1 On the [Home] screen of the control panel, press [Display Order (Home)] ▶ **OK**. ▶  
[Home] Screen(P. 94)

- 2 Use ▲ or ▼ to select the item you want to move, and then press **OK**.

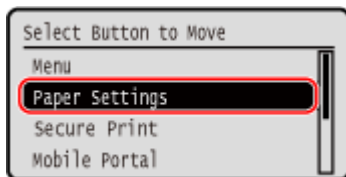

- 3 Use ▲ or ▼ to move the item, and then press **OK**.

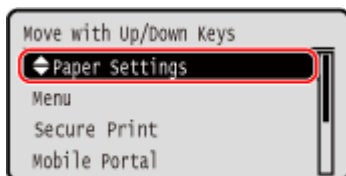

- 4 Press **OK**.

⇒ The display order of the items on the [Home] screen is changed.

## Logging In to the Machine

9664-02A

When the login screen is displayed on the control panel, enter the required login information to perform authentication. When authentication is successful, the screen changes, and you can continue operations.

When Department ID Management is set up, the following login screen is displayed. Enter the Department ID to log in. If a PIN is set, enter the PIN.

When the System Manager ID is set, the login screen is displayed for operations that require administrator privileges. Enter the System Manager ID and PIN to log in.

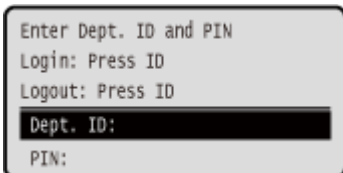

Enter Dept. ID and PIN  
 Login: Press ID  
 Logout: Press ID  
 Dept. ID:  
 PIN:

- 1** Select [Department ID], and press **OK**.
- 2** Enter the Department ID or System Manager ID and press **OK**.
- 3** Select [PIN], and press **OK**.
- 4** Enter the PIN, and press **OK**.
- 5** Press **ID**.

⇒ When authentication is successful, the [Home] screen or other screen is displayed.

- 6** When you have completed your operations, press **ID**.

# Loading Paper

---

9664-02C

To ensure print quality, confirm the usable paper and how to handle and store paper, and prepare the appropriate paper for use with the machine. [▶ Usable Paper\(P. 18\)](#) / [▶ Precautions When Handling Paper\(P. 22\)](#)

Load the prepared paper in the machine, and then configure the paper size and type settings.

## Loading Paper in the Machine

Load paper you usually use into the paper drawer, which can hold large amounts of paper.

To temporarily use paper not loaded in the paper drawer, load it in the multi-purpose tray.

[▶ Loading Paper in the Paper Drawer\(P. 105\)](#)

[▶ Loading Paper in the Multi-purpose Tray\(P. 110\)](#)

When using envelopes or paper with logos, be careful of the orientation of the loaded paper and which side is face up.

[▶ Preparations and Orientation for Loading Envelopes\(P. 113\)](#)

[▶ Orientation for Loading Paper with a Logo\(P. 115\)](#)

## Paper Settings

To ensure quality printing and prevent paper jams, the paper size and type must be set correctly according to the loaded paper.

[▶ Specifying the Paper Size and Type\(P. 119\)](#)



# Loading Paper in the Paper Drawer

Load paper you usually use into the paper drawer, which can hold large amounts of paper. The setting method varies depending on the size of the paper to be loaded.

## When Loading A4, B5, Legal, or Letter Size Paper

Load paper using the standard size method.

▶ **Loading Standard Size Paper(P. 105)**

## When Loading A5 Size Paper

The setting method varies depending on the orientation of the paper to be loaded.

### Landscape orientation (A5)

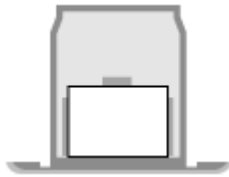

▶ **Loading Non-standard Size Paper(P. 107)**

### Portrait orientation (A5R)

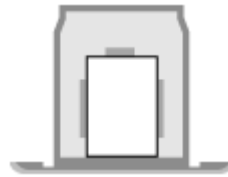

▶ **Loading Standard Size Paper(P. 105)**

## When Loading A6 Size Paper

Load paper in portrait orientation using the non-standard size method.

▶ **Loading Non-standard Size Paper(P. 107)**

## When Loading Custom Size Paper

Load paper using the non-standard size method.

▶ **Loading Non-standard Size Paper(P. 107)**

## NOTE

- Load paper using the same procedure even when using the optional Cassette Feeding Module-AH.

## Loading Standard Size Paper

You can load paper correctly by aligning the paper guides on the paper drawer with the markings. When using paper with logos, be careful of the orientation of the loaded paper and which side is face up. ▶ **Orientation for Loading Paper with a Logo(P. 115)**

### 1 Pull out the paper drawer.

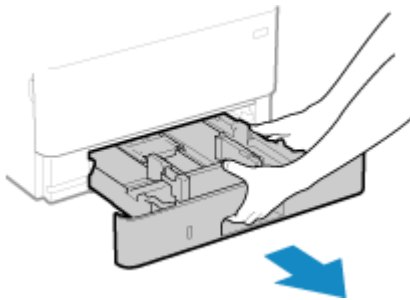

Always hold the paper drawer with both hands and pull it out gently. If you pull the drawer out with only one hand, it may be too heavy to hold, causing it to fall and be damaged.

### 2 Align the paper guides with the size of the paper to be loaded.

- 1 While pressing the lock release lever, move the paper guide.

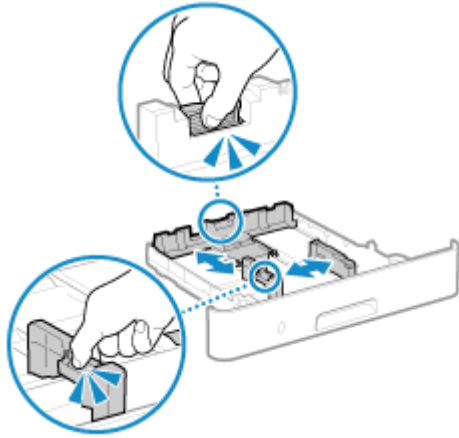

- 2 Align the projections on the paper guides with the size markings of the paper to be loaded.

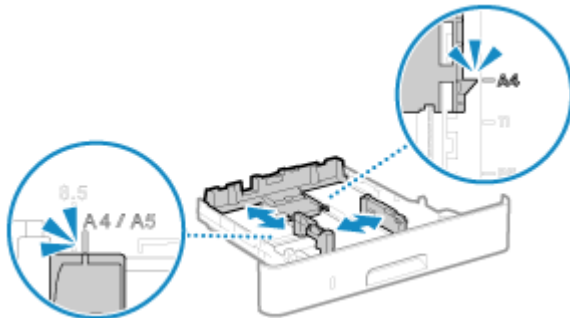

Paper guides that are aligned but too loose or too tight can cause misfeeds or a paper jam.

- 3 Fan the paper and align the edges.



Fan the paper in small batches, and align the edges by tapping the paper on a flat surface a few times.

- 4 Load the paper with the print side face down.

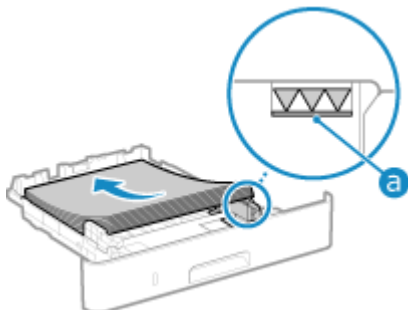

- Align the paper with the paper guide on the rear edge of the paper drawer.
- Make sure the loaded paper does not exceed the load limit line (a). If it exceeds the load limit line, there may be misfeeds or a paper jam.

#### ■ When Printing on the Back Side of Printed Paper (Manual 2-sided Printing)

Flatten the edge of the paper to remove any curls, and load the paper with the back (unprinted) side face down.

- You can use only paper printed with this machine.
- You cannot print on a side that has been previously printed on.
- If the printouts look faded, adjust the image quality. ▶[Manual Back Side Print (2-Sided Only)](P. 310)

## 5 Load the paper drawer into the machine.

▶▶ By default, the Paper Settings confirmation screen is displayed. ▶[Notify to Check Paper Settings] (P. 347)

## 6 Set the paper size and type, as needed. ▶Setting the Paper Size and Type for the Paper Drawer(P. 120)

By default, the paper size and type of the paper drawer are set to A4 and Plain 2. When paper of a different size or type is loaded, change the paper settings.

### Loading Non-standard Size Paper

You can load paper correctly by aligning the paper guides on the paper drawer with the paper. When using paper with logos, be careful of the orientation of the loaded paper and which side is face up. ▶Orientation for Loading Paper with a Logo(P. 115)

### 1 Pull out the paper drawer.

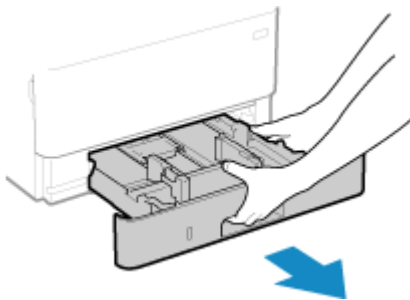

Always hold the paper drawer with both hands and pull it out gently. If you pull the drawer out with only one hand, it may be too heavy to hold, causing it to fall and be damaged.

### 2 Slide the paper guides to the outside.

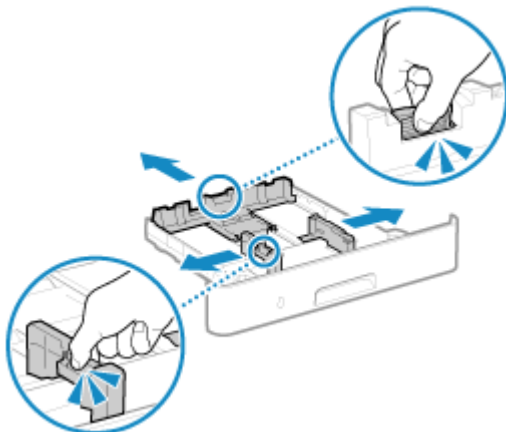

While pressing the lock release lever, move the paper guides.

### 3 Fan the paper and align the edges.



Fan the paper in small batches, and align the edges by tapping the paper on a flat surface a few times.

#### 4 Load the paper with the print side face down.

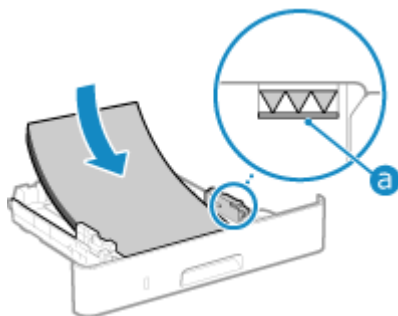

- Load the paper against the front side of the paper drawer.
- Make sure the loaded paper does not exceed the load limit line (a). If it exceeds the load limit line, there may be misfeeds or a paper jam.

#### ■ When Printing on the Back Side of Printed Paper (Manual 2-sided Printing)

Flatten the edge of the paper to remove any curls, and load the paper with the back (unprinted) side face down.

- You can use only paper printed with this machine.
- You cannot print on a side that has been previously printed on.
- If the printouts look faded, adjust the image quality. [▶\[Manual Back Side Print \(2-Sided Only\)\]\(P. 310\)](#)

#### 5 Align the paper guides with the width and length of the paper.

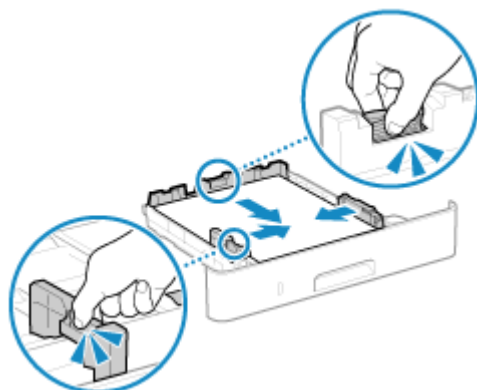

- While pressing the lock release lever, align the paper guides with the width and length of the paper.
- Paper guides that are aligned but too loose or too tight can cause misfeeds or a paper jam.

#### 6 Load the paper drawer into the machine.

- ▶ By default, the Paper Settings confirmation screen is displayed. [▶\[Notify to Check Paper Settings\]\(P. 347\)](#)

## **7 Set the paper size and type. ▶Setting the Paper Size and Type for the Paper Drawer(P. 120)**

By default, the paper size and type of the paper drawer are set to A4 and Plain 2. When paper of a different size or type is loaded, change the paper settings.

# Loading Paper in the Multi-purpose Tray

9664-02F

To temporarily use paper not loaded in the paper drawer, load it in the multi-purpose tray. You can load paper correctly by aligning the paper guides on the multi-purpose tray with the paper. When using envelopes or paper with logos, be careful of the orientation of the loaded paper and which side is face up.

🔴 **Preparations and Orientation for Loading Envelopes(P. 113)**

🔴 **Orientation for Loading Paper with a Logo(P. 115)**

## ! IMPORTANT

### Do Not Remove the Paper Drawer

- If the paper drawer is removed, the machine cannot print even when paper is loaded in the multi-purpose tray. If you try to print with the paper drawer removed, an error message appears.

### 1 Hold both sides of the cover when opening it.

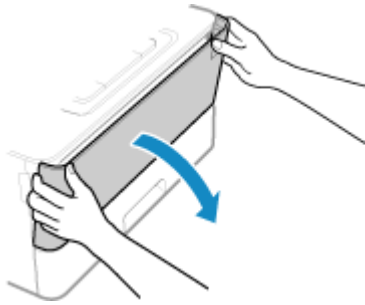

### 2 Pull out the paper tray and open the extension tray.

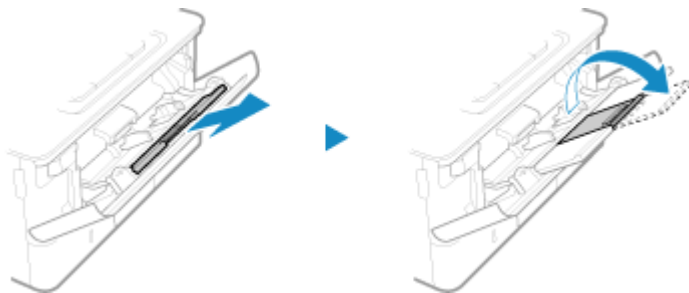

Open the extension tray when loading large paper sizes.

### 3 Spread the paper guides apart.

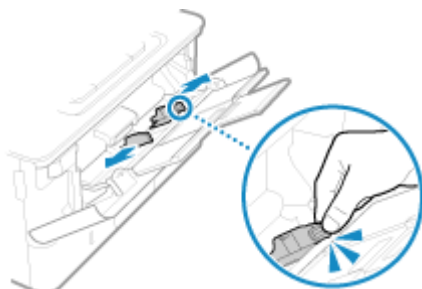

While pressing the lock release lever, move the paper guides.

#### 4 Fan the paper and align the edges.



Fan the paper in small batches, and align the edges by tapping the paper on a flat surface a few times.

#### 5 Load the paper with the print side face up.

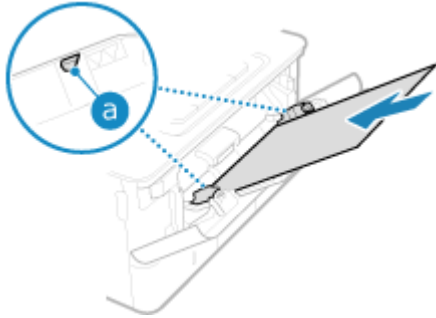

- Insert the paper until the edge of the paper is against the paper tray.
- Make sure the loaded paper does not exceed the load limit guide (a). If it exceeds the load limit guide, there may be misfeeds or a paper jam.

#### ■ When Printing on the Back Side of Printed Paper (Manual 2-sided Printing)

Flatten the edge of the paper to remove any curls, and load the paper with the back (unprinted) side face up.

- You can use only paper printed with this machine.
- You cannot print on a side that has been previously printed on.
- You cannot load more than one sheet of paper. Load each sheet separately to print.
- If the printouts look faded, adjust the image quality. ▶[Manual Back Side Print (2-Sided Only)](P. 310)

#### 6 Align the paper guides with the width of the paper.

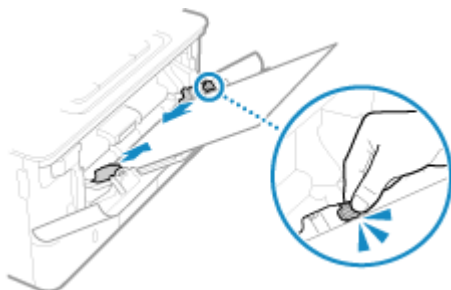

- While pressing the lock release lever, align the paper guides with the width of the paper.
- Paper guides that are aligned but too loose or too tight can cause misfeeds or a paper jam.

#### 7 Set the paper size and type. ▶Setting the Paper Size and Type for the Multi-purpose Tray(P. 122)

By default, when the machine detects paper loaded in the multi-purpose tray, the screen for setting the paper size and type is displayed on the control panel. Set the paper size and type each time you load paper.

## NOTE

### When Loading A5 or A6 Size Paper

- Set the paper size according to the orientation of the loaded paper.
- Load A6 paper in portrait orientation.

Landscape orientation (A5)



Portrait orientation (A5R or A6)





# Preparations and Orientation for Loading Envelopes

9664-02H

As envelopes have a different shape and thickness from regular paper, preparations must be made before loading envelopes.

Envelopes can be printed only on the front side (non-glued side). Load the envelope in the multi-purpose tray, taking care to check the orientation of the envelope and that the correct side is facing up.

▶ **Preparations before Loading Envelopes(P. 113)**

▶ **Orientation of Envelopes(P. 114)**

## NOTE

- For the general procedure of loading envelopes in the multi-purpose tray, see the following:  
▶ **Loading Paper in the Multi-purpose Tray(P. 110)**

## Preparations before Loading Envelopes

Align the envelopes regardless of the number of envelopes to be loaded.

**1 Close the flap of each envelope.**



**2 Flatten them to remove any air, and make sure the edges are pressed tightly.**



**3 Loosen any stiff corners of the envelopes, and flatten any curls.**

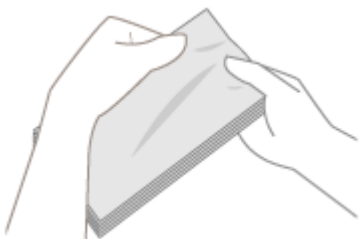

**4 Align the edges of the envelopes on a flat surface.**

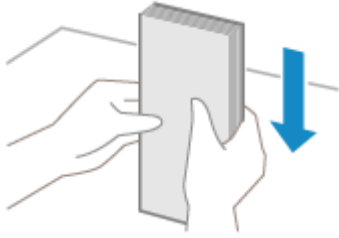

► The envelopes are ready to be loaded.

## Orientation of Envelopes

Insert the envelopes No. 10 (COM10), Monarch, ISO-C5, or DL from the short side with the front side (non-glued side) face up. Insert the envelope with the flap closed and on the left side.

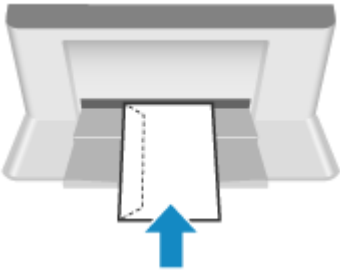

## Orientation for Loading Paper with a Logo

9664-02J

When loading paper with a logo, pay attention to the orientation and which side is face up. By default, the orientation the paper is to be loaded and the side to print on vary depending on whether you want to print on one or both sides.

- ▶ **Printing on One Side of Paper with a Logo(P. 115)**
- ▶ **Printing on Both Sides of Paper with a Logo(P. 117)**

### NOTE

- For the general procedure of loading paper, see the following:
  - ▶ **Loading Paper in the Paper Drawer(P. 105)**
  - ▶ **Loading Paper in the Multi-purpose Tray(P. 110)**
- You can configure the settings so that the orientation the paper is to be loaded and the side to print on do not change depending on whether you want to print on one or both sides. When this setting is configured, load the paper using the 2-sided printing method. ▶ **[Switch Paper Feed Method](P. 320)**

### Printing on One Side of Paper with a Logo

#### Paper with Logo in Portrait Orientation



#### Loading Paper with a Logo in the Paper Drawer

Load the paper with the logo side (side to be printed) face down.

Loading Orientation

**Portrait**



**Landscape (A5)**



#### Loading Paper with a Logo in the Multi-purpose Tray

Load the paper with the logo side (side to be printed) face up.

Loading Orientation

Portrait

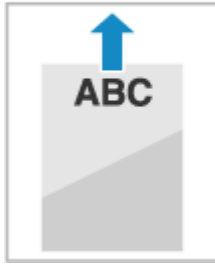

Landscape (A5)

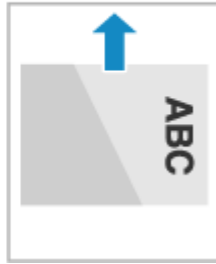

**Paper with Logo in Landscape Orientation**

---

Preprinted Paper



Document



Print Result

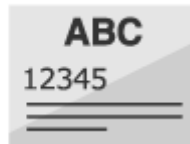

**Loading Paper with a Logo in the Paper Drawer**

Load the paper with the logo side (side to be printed) face down.

Loading Orientation

Portrait

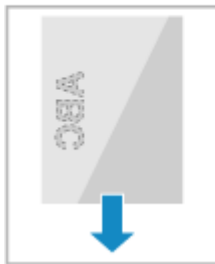

Landscape (A5)



**Loading Paper with a Logo in the Multi-purpose Tray**

Load the paper with the logo side (side to be printed) face up.

Loading Orientation

Portrait

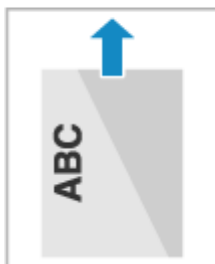

Landscape (A5)

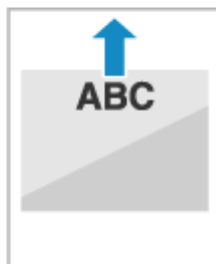

## Printing on Both Sides of Paper with a Logo

### Paper with Logo in Portrait Orientation

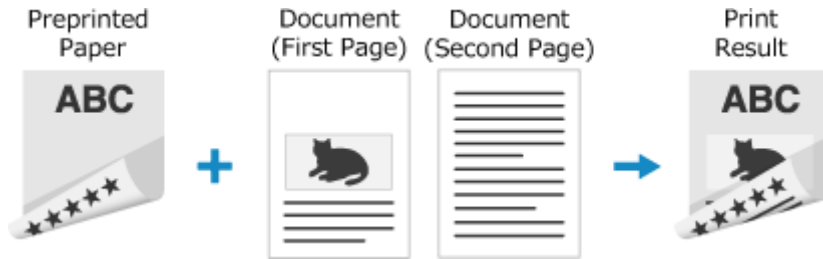

#### Loading Paper with a Logo in the Paper Drawer

Load the paper with the logo side (side to be printed first) face up.

Loading Orientation

#### Portrait

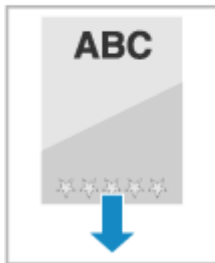

#### Landscape (A5)

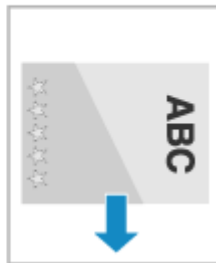

#### Loading Paper with a Logo in the Multi-purpose Tray

Load the paper with the logo side (side to be printed first) face down.

Loading Orientation

#### Portrait

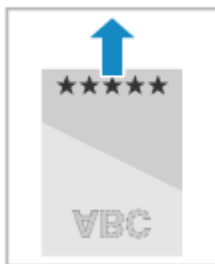

#### Landscape (A5)



### Paper with Logo in Landscape Orientation

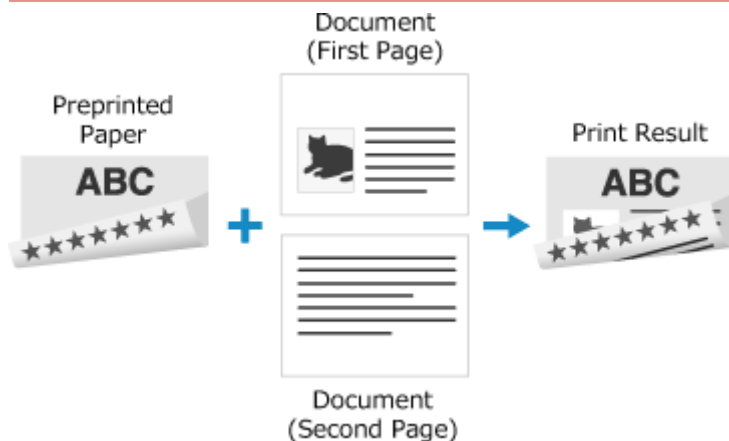

**Loading Paper with a Logo in the Paper Drawer**

Load the paper with the logo side (side to be printed first) face up.

Loading Orientation

**Portrait**

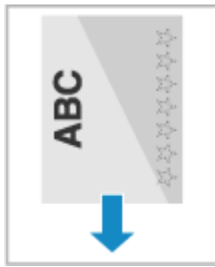

**Landscape (A5)**



**Loading Paper with a Logo in the Multi-purpose Tray**

Load the paper with the logo side (side to be printed first) face down.

Loading Orientation

**Portrait**

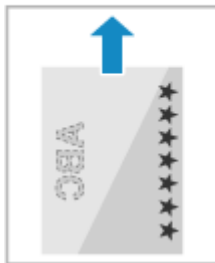

**Landscape (A5)**



## Specifying the Paper Size and Type

---

9664-02K

To ensure quality printing and prevent paper jams, the paper size and type must be set correctly according to the loaded paper.

You can register frequently used paper settings and hide unneeded paper settings to simplify the paper settings.

### Settings Required after Loading the Paper

Set the paper size and type according to the loaded paper.

- ▶ **Setting the Paper Size and Type for the Paper Drawer(P. 120)**
- ▶ **Setting the Paper Size and Type for the Multi-purpose Tray(P. 122)**

If you always use the same paper in the multi-purpose tray, you can register the paper to use so you do not have to configure the settings each time.

- ▶ **Registering a Frequently Used Paper Size and Type for the Multi-purpose Tray(P. 124)**

### Simplifying the Paper Settings

You can register and set the paper size for easier settings.

- ▶ **Registering Non-standard Size Paper (Custom Paper)(P. 126)**
- ▶ **Hiding Unused Paper Sizes(P. 127)**

### Using Appropriate Paper

You can configure the settings to automatically select the paper source with the appropriate paper when printing.

- ▶ **Using the Appropriate Paper Source for Each Function(P. 128)**

# Setting the Paper Size and Type for the Paper Drawer

9664-02L

By default, the paper size and type of the paper drawer are set to A4 and Plain 2. When paper of a different size or type is loaded, change the paper settings.

This section describes how to configure the settings using the control panel.

You can also configure the settings using Remote UI from a computer. ▶ **Managing the Machine from a Computer (Remote UI)(P. 255)**

- 1 On the control panel, select [Paper Settings] in the [Home] screen, and press **OK**. ▶ **[Home] Screen(P. 94)**

- 2 Select the paper drawer whose setting you want to change, and press **OK**.

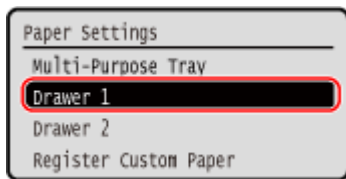

- 3 Select the size of the paper loaded in the paper drawer, and press **OK**.

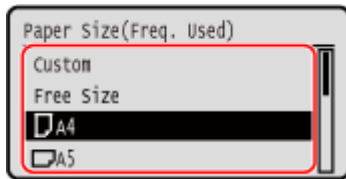

- You can scroll the screen to view paper sizes not displayed on the screen.
- If you frequently need to change the paper to be loaded, set to [Free Size]; this will reduce the number of steps required to change the setting each time. You can also display an error message when the setting in the printer driver is significantly different from the size of the loaded paper. ▶ **[Action When Free Paper Size Mismatch](P. 323)**

## ■ When A5 Size Paper Is Loaded

When paper is loaded in the landscape orientation, select [A5]. When paper is loaded in the portrait orientation, select [A5R].

Landscape orientation (A5)



Portrait orientation (A5R)

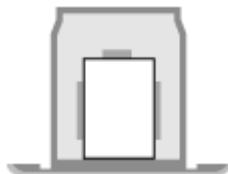

## ■ When Non-standard Size (Custom Size) Paper Is Loaded

- 1 Select [Custom], and press **OK**.
- 2 Press [X] ▶ **OK** ▶ enter the values in [X] ▶ **OK**.



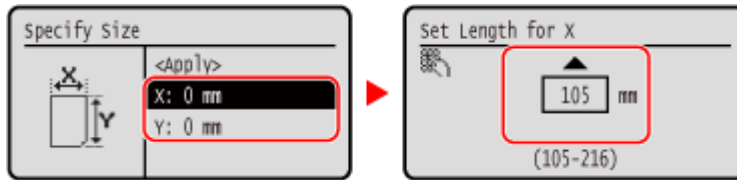

- 3 Enter the values in [Y] in the same way as [X].
- 4 Select [<Apply>], and press **OK**.

#### ■ If a Set Paper Size Is Not Displayed

Press [<Other Sizes>], press **OK**, and select the paper size from the displayed list.

- 4 Select the type of the paper loaded in the paper drawer, and press **OK**.

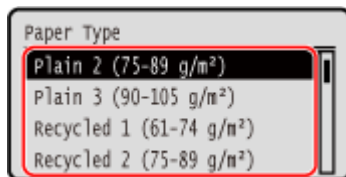

If you frequently need to change the paper to be loaded, set to [Free]; this will reduce the number of steps required to change the setting each time. However, note that this setting lets the machine perform printing even if there is mismatch between the paper type setting in the printer driver and the paper type actually loaded in the machine.

When the paper type setting in the printer driver is [Auto], the machine operates the same way as when the paper type is [Plain 1].

⇒ The paper size and type are set.

## NOTE

- You can change the paper size displayed on the screen in Step 3. **▶ Hiding Unused Paper Sizes(P. 127)**

# Setting the Paper Size and Type for the Multi-purpose Tray

9664-02R

When paper is loaded in the multi-purpose tray, the following screen is displayed on the control panel. Set the paper size and type according to the loaded paper.

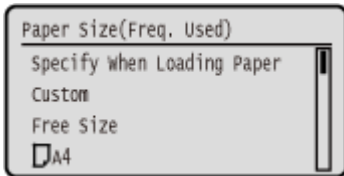

\* If the paper size and type of the multi-purpose tray have been registered in advance, the above screen is not displayed. **▶ Registering a Frequently Used Paper Size and Type for the Multi-purpose Tray(P. 124)**

This section describes how to configure the settings using the control panel. You can also configure the settings using Remote UI from a computer. **▶ Managing the Machine from a Computer (Remote UI)(P. 255)**

## 1 Select the size of the paper loaded in the multi-purpose tray, and press **OK**.

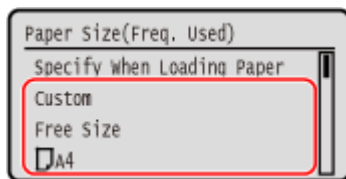

- You can scroll the screen to view paper sizes (such as envelopes) not displayed on the screen.
- If you frequently need to change the paper to be loaded, set to [Free Size]; this will reduce the number of steps required to change the setting each time. You can also display an error message when the setting in the printer driver is significantly different from the size of the loaded paper. **▶ [Action When Free Paper Size Mismatch](P. 323)**

### ■ When A5 Size Paper Is Loaded

When paper is loaded in the landscape orientation, select [A5]. When paper is loaded in the portrait orientation, select [A5R].

Landscape orientation (A5)



Portrait orientation (A5R)



### ■ When Non-standard Size (Custom Size) Paper Is Loaded

- 1 Select [Custom], and press **OK**.
- 2 Press [X] ▶ **OK** ▶ enter the values in [X] ▶ **OK**.

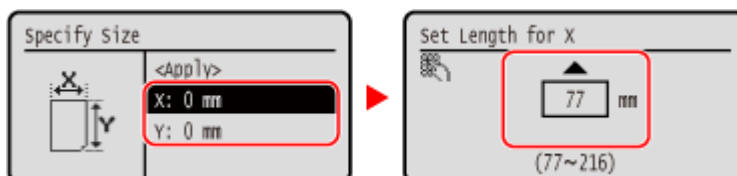

3 Enter the values in [Y] in the same way as [X].

4 Select [<Apply>], and press **OK**.

#### ■ If a Set Paper Size Is Not Displayed

Press [<Other Sizes>], press **OK**, and select the paper size from the displayed list.

2 Select the type of paper loaded in the multi-purpose tray, and press **OK**.

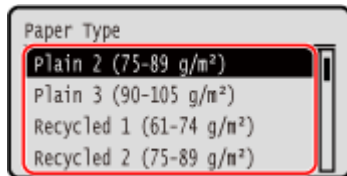

If you frequently need to change the paper to be loaded, set to [Free]; this will reduce the number of steps required to change the setting each time. However, note that this setting lets the machine perform printing even if there is mismatch between the paper type setting in the printer driver and the paper type actually loaded in the machine.

When the paper type setting in the printer driver is [Auto], the machine operates the same way as when the paper type is [Plain 1].

⇒ The paper size and type are set.

## NOTE

- You can change the paper size displayed on the screen in Step 1. [▶ Hiding Unused Paper Sizes\(P. 127\)](#)

# Registering a Frequently Used Paper Size and Type for the Multi-purpose Tray

9664-02S

By default, when paper is loaded in the multi-purpose tray, the screen for setting the paper size and type is displayed on the control panel.

If you always use the same paper in the multi-purpose tray, you can register the paper size and type. This prevents the paper settings screen from being displayed, saving you the trouble of configuring the settings.

## When Using Paper of a Size or Type Different from the Registered Paper

After canceling the registration in Step 3, load the paper in the multi-purpose tray. When the screen for setting the paper size and type is displayed on the control panel, configure the settings according to the paper to be used. [▶Setting the Paper Size and Type for the Multi-purpose Tray\(P. 122\)](#)

This section describes how to register the settings using the control panel.

You can also register the settings using Remote UI from a computer. [▶Managing the Machine from a Computer \(Remote UI\)\(P. 255\)](#)

**1** On the control panel, select [Paper Settings] in the [Home] screen, and press **OK**. [▶ \[Home\] Screen\(P. 94\)](#)

**2** Select the multi-purpose tray, and press **OK**.

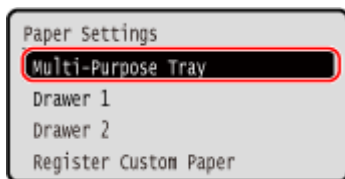

**3** Select the paper size to register, and press **OK**.

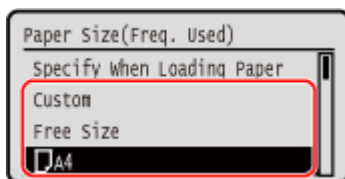

- You can scroll the screen to view paper sizes (such as envelopes) not displayed on the screen.
- If you frequently need to change the paper to be loaded, set to [Free Size]; this will reduce the number of steps required to change the setting each time. You can also display an error message when the setting in the printer driver is significantly different from the size of the loaded paper. [▶\[Action When Free Paper Size Mismatch\]\(P. 323\)](#)

## ■When A5 Size Paper Is Loaded

When paper is loaded in the landscape orientation, select [A5]. When paper is loaded in the portrait orientation, select [A5R].

Landscape orientation (A5)



Portrait orientation (A5R)



### ■When Non-standard Size (Custom Size) Paper Is Loaded

- 1 Select [Custom], and press **OK**.
- 2 Press [X] ► **OK** ► enter the values in [X] ► **OK**.

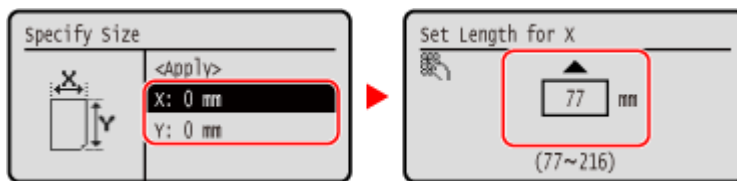

- 3 Enter the values in [Y] in the same way as [X].
- 4 Select [<Apply>], and press **OK**.

### ■If a Set Paper Size Is Not Displayed

Press [<Other Sizes>], press **OK**, and select the paper size from the displayed list.

### ■To Cancel the Registered Paper

Select [Specify When Loading Paper], and press **OK**. You do not need to perform Step 4.

When paper is loaded in the multi-purpose tray, the screen for setting the paper size and type is displayed on the control panel.

## 4 Select the paper type to register, and press **OK**.

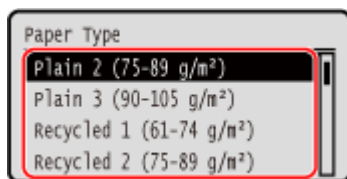

If you frequently need to change the paper to be loaded, set to [Free]; this will reduce the number of steps required to change the setting each time. However, note that this setting lets the machine perform printing even if there is mismatch between the paper type setting in the printer driver and the paper type actually loaded in the machine.

When the paper type setting in the printer driver is [Auto], the machine operates the same way as when the paper type is [Plain 1].

⇒ The paper size and type are set.

## NOTE

- You can change the paper size displayed on the screen in Step 3. **▶Hiding Unused Paper Sizes(P. 127)**

## Registering Non-standard Size Paper (Custom Paper)

9664-02U

Custom paper is non-standard size paper whose side lengths can be freely defined within the range supported by the machine.

You can register sizes when frequently using specific non-standard size paper. You can call up the paper on the size input screen, saving you the trouble of entering the size.

You can register up to three custom sizes.

This section describes how to register the settings using the control panel.

You can also register the settings using Remote UI from a computer. [▶Managing the Machine from a Computer \(Remote UI\)\(P. 255\)](#)

- 1 On the control panel, select [Paper Settings] in the [Home] screen, and press **OK**.** [▶ \[Home\] Screen\(P. 94\)](#)

- 2 Select [Register Custom Paper], and press **OK**.**

⇒ The [Register Custom Paper] screen is displayed.

- 3 Select the registration number, and press **OK**.**

If you have selected the registered number, continue on to select [Edit], and press **OK**.

- 4 Press **[X]** ▶ **OK** ▶ enter the values in **[X]** ▶ **OK**.**

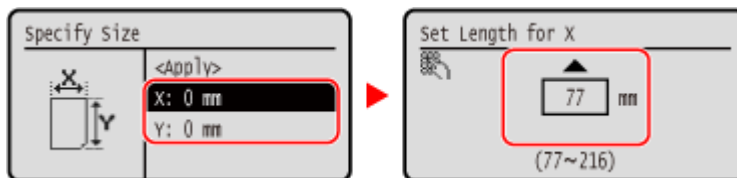

- 5 Enter the values in [Y] in the same way as [X].**

- 6 Select [**<Apply>**], and press **OK**.**

- 7 Select the type of the paper, and press **OK**.**

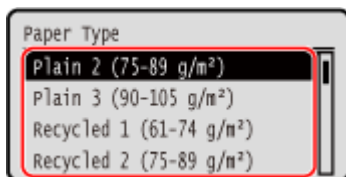

If you frequently need to change the paper to be loaded, set to [Free]; this will reduce the number of steps required to change the setting each time. However, note that this setting lets the machine perform printing even if there is mismatch between the paper type setting in the printer driver and the paper type actually loaded in the machine.

When the paper type setting in the printer driver is [Auto], the machine operates the same way as when the paper type is [Plain 1].

⇒ The custom paper is registered.

## Hiding Unused Paper Sizes

9664-02W

The paper settings screen displays the registered frequently used paper sizes. If unused paper sizes are displayed, you can hide these for each paper source to make it easier to select a paper size. To select a hidden paper size, press [Other Sizes] on the paper settings screen.

Use the control panel to configure the settings. You cannot configure the settings using Remote UI from a computer.

**1** On the control panel, select [Paper Settings] in the [Home] screen, and press **OK**.   
[Home] Screen(P. 94)

**2** Select [Select Frequently Used Paper Sizes], and press **OK**.

⇒ The [Select Frequently Used Paper Sizes] screen is displayed.

**3** Select a paper source, and press **OK**.

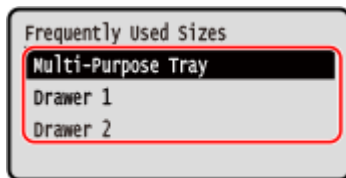

**4** Clear the checkboxes of the paper sizes to hide, and press [<Apply>]  **OK**.

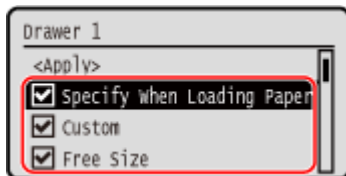

⇒ Paper sizes whose checkboxes are cleared are not displayed on the paper settings screen.

# Using the Appropriate Paper Source for Each Function

9664-02X

If you print without specifying the paper source, the machine automatically selects the paper source according to the size of the paper to be printed. In addition, if the machine runs out paper while printing, it automatically selects another paper source loaded with the same size paper to continue printing.

You can use the appropriate paper source by setting the paper source that is selected automatically for each function.

This section describes how to configure the settings using Remote UI from a computer.

On the control panel, select [Menu] in the [Home] screen, and then select [Function Settings] to configure the settings.

➤ [Drawer Auto Selection On/Off] (P. 319)

## 1 Log in to Remote UI. ➤ Starting Remote UI (P. 256)

## 2 On the Portal page of Remote UI, click [Settings/Registration]. ➤ Portal Page of Remote UI (P. 259)

## 3 Click [Common Settings] ▶ [Edit].

⇒ The [Edit Common Settings] screen is displayed.

## 4 In [Paper Source Auto Selection], set the paper source to be selected automatically to [On].

- Configure this setting for each function. For printing reports and lists, set the paper source to [Other] to apply this setting.
- For each function, one of the paper drawers must be set for automatic selection. If the multi-purpose tray only is set for automatic selection, the setting cannot be completed.

## 5 Click [OK].

⇒ The settings are applied.

## 6 Log out from Remote UI.



## Inserting and Removing a USB Memory Device

9664-02Y

You can insert a USB memory device into the machine to exchange data between the machine and the USB memory device.

Use the control panel to safely remove the USB memory device from the machine.

You can use a USB memory device with a FAT16 (up to 2 GB) or FAT32 (up to 32 GB) file system.

▶ **Inserting a USB Memory Device(P. 129)**

▶ **Removing the USB Memory Device(P. 130)**

### ! IMPORTANT

#### Saving Data to a USB Memory Device

- Data may not be able to be saved properly depending on the USB memory device.

#### Unsupported Devices

- USB memory devices with a security function
- USB memory devices that do not conform to USB standards
- USB card readers
- USB memory devices connected via an extension cable
- USB memory devices connected via a USB hub

#### Handling USB Memory Devices

- Do not remove the USB memory device or subject it to shocks or vibration or turn OFF the machine while data is being imported or exported.

## Inserting a USB Memory Device

Confirm the orientation of the USB memory device, and insert it into the USB port on the back of the machine.

### ! IMPORTANT

#### Confirm the Orientation of the USB Memory Device before Inserting

- Make sure that the USB memory device is correctly oriented before inserting it into the USB port on the machine. If you attempt to insert it in the incorrect orientation, the memory device and the machine may be damaged.

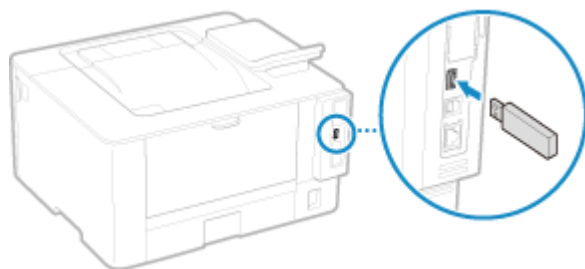

## Removing the USB Memory Device

Use the control panel to eject the USB memory device from the machine. You cannot eject the memory device using Remote UI from a computer.

### **IMPORTANT**

#### Follow the Procedure to Remove the USB Memory Device

- If you do not remove the USB memory device while following the procedure, the memory device and the machine may be damaged.

**1** Press  on the control panel.  **Control Panel(P. 14)**

⇒ The [Status Monitor] screen is displayed.

**2** Press [Device Status] ▶  ▶ [Remove Memory Media] ▶ .

**3** Make sure that [The memory media can be safely removed.] is displayed, and then remove the USB memory device.

## Adjusting the Sound Volume

---

9664-032

You can set whether the machine emits sounds notifying you of operations and statuses.

▶ **Adjusting the Volume(P. 132)**

# Adjusting the Volume

---

9664-033

You can also set whether the machine emits sounds notifying you of operations and statuses, such as when operating the control panel and errors are detected.

This section describes how to configure the settings using the control panel.



You can also configure the settings using Remote UI from a computer. ▶ **Managing the Machine from a Computer (Remote UI)(P. 255)**

**1 On the control panel, select [Menu] in the [Home] screen, and press . ▶ [Home] Screen(P. 94)**

**2 Press [Preferences] ▶  ▶ [Volume Settings] ▶ .**

⇒ The [Volume Settings] screen is displayed.

**3 Set whether notification sounds are emitted. ▶ [Volume Settings] Screen(P. 133)**

To emit notification sounds, select the item and press  ▶ [On] ▶ .

⇒ The notification sound settings are applied.

## [Volume Settings] Screen

---

9664-034

You can set whether the machine emits sounds notifying you of operations and statuses.

When you press [Menu] in the [Home] screen ► **OK** ► [Preferences] ► **OK** ► [Volume Settings] ► **OK**, the [Volume Settings] screen is displayed.

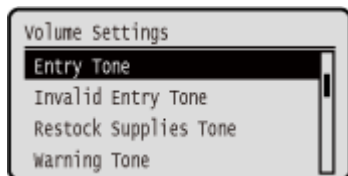

### [Entry Tone]

Set whether to emit a sound when you press the keys and buttons on the control panel.

### [Invalid Entry Tone]

Set whether to emit a sound when an invalid key is pressed, such as when you enter a value outside the setting range.

### [Restock Supplies Tone]

Set whether to emit a sound when the toner cartridge is nearing the end of its lifetime.

### [Warning Tone]

Set whether to emit a sound when the machine has a paper jam or other malfunction.

### [Job Done Tone]

Set whether to emit a sound when the print operation is completed.

### [Energy Saver Alert]

Set whether to emit a sound when the machine enters and exits sleep mode.

# Printing

<b>Printing</b> .....	135
<b>Printing Preparations</b> .....	137
Preparing to Print from a Computer .....	138
Configuring a Printer Port (Windows) .....	141
Setting Up a Print Server .....	144
Preparations for Using Universal Print .....	147
Registering the Machine to Cloud Service .....	148
Registering the Machine to the Computer .....	151
Preparing to Receive and Print I-Faxes .....	152
<b>Printing from a Computer</b> .....	154
Registering Non-standard Size Paper to the Computer (Custom Size) .....	157
Printing a Document Secured with a PIN (Secure Print) .....	159
Changing the Time Period That Print Data with a PIN (Secure Data) Is Saved .....	162
Enabling Secure Print in a Printer Driver (macOS) .....	163
Printing with Universal Print .....	164
<b>Receiving and Printing I-Faxes</b> .....	165
Changing the Print Settings of the Received I-Fax .....	166
<b>Canceling Printing</b> .....	167
<b>Viewing the Print Job Status and Log</b> .....	169

# Printing

---

You can print documents and photos from a computer. The machine can also receive and print I-Faxes.

## Printing from a Computer

---

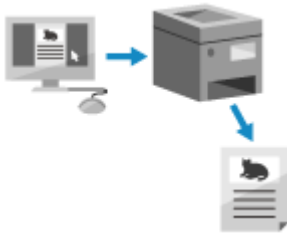

You can print documents and photos via a printer driver installed on a computer connected to the machine.

- ▶ **Preparing to Print from a Computer(P. 138)**
- ▶ **Printing from a Computer(P. 154)**

### Setting Up a Print Server

By setting up a print server on a network, you can reduce the load on the computer that you print from. In Windows, you can install the printer driver via the print server, which saves you the trouble of downloading the printer driver to each computer on the network or using a CD/DVD-ROM.

- ▶ **Setting Up a Print Server(P. 144)**

### Printing with a PIN

When printing from a computer, you can send print data to the machine after setting a PIN. Printing is not performed until the PIN is entered on the machine, thereby preventing unattended printed documents and information theft.

- ▶ **Printing a Document Secured with a PIN (Secure Print)(P. 159)**

## Printing with the Standard Functions of the Operating System and Cloud Service

---

You can print without having to install a dedicated application or printer driver.

### Windows

This machine is compatible with Universal Print, a cloud service by Microsoft. You can print documents from a remote location as long as your computer is connected to the Internet.

- ▶ **Preparations for Using Universal Print(P. 147)**
- ▶ **Printing with Universal Print(P. 164)**

### macOS

You can use AirPrint to print data. ▶ **Using AirPrint Application to Print Data(P. 183)**

### Chrome OS

Use the print function that is standard in the operating system. ▶ **Printing from Chromebook or Other Device with Chrome OS(P. 188)**

## Receiving and Printing I-Faxes

---



Internet Fax (I-Fax) is a function for sending and receiving faxes via the Internet. The machine cannot send I-Faxes, but it can receive and print I-Faxes.

The machine for sending I-Faxes must support I-Fax technology.

- ▶ **Preparing to Receive and Print I-Faxes(P. 152)**
- ▶ **Receiving and Printing I-Faxes(P. 165)**

## ■ See Also

### Printing from a Mobile Device

The machine can be operated from a smartphone, tablet, or other mobile device. By using a compatible application or service, you can easily print photos or documents from a mobile device.

- ▶ **Linking with Mobile Devices(P. 171)**

### When Results Are Not as Expected

If the print density varies or the image position is shifted, adjust the print quality and position according to the symptoms that occur.

▶ **Adjusting the Print Quality and Position(P. 380)**



# Printing Preparations

---

9664-0CA

To print from the machine, you must make printing preparations according to your printing method and usage environment.

- ▶ **Preparing to Print from a Computer(P. 138)**
- ▶ **Setting Up a Print Server(P. 144)**
- ▶ **Preparations for Using Universal Print(P. 147)**

# Preparing to Print from a Computer

9664-037

Make the following preparations for the computer that will be used to print.

- ▶ **Step 1: Installing the Driver to the Computer(P. 138)**
- ▶ **Step 2: Using a Driver to Set the Department ID and PIN(P. 138)**
- ▶ **Step 3: Configuring the Option Settings of the Machine Using the Driver(P. 138)**

## Step 1: Installing the Driver to the Computer

Install the printer driver to the computer that will be used to print. ▶ **Installing Software and Drivers to the Computer(P. 79)**

### Using a Print Server in Windows

Use a print server to install the printer driver.

Double-click the shared printer on the print server, and follow the instructions on the screen to install the printer driver. ▶ **Displaying a Shared Printer in the Print Server(P. 472)**

## NOTE

### Changing the Port Type and Number (Windows)

- If the machine is configured not to use LPD or RAW, or if the port number was changed, the settings on the computer may also have to be changed. ▶ **Changing the Port Type and Number(P. 142)**

### If the IP Address of the Machine Is Changed after Installing the Printer Driver

- You must add a new port. ▶ **Adding a Port(P. 141)**  
If you do not know which port is being used, see the following:  
▶ **Viewing the Printer Port(P. 477)**
- In macOS, you must re-register the machine on the Mac. For details about registering the machine, see the manual of the driver at the online manual site.

<https://oip.manual.canon/>

\* If you are using DHCP to automatically obtain the IP address of the machine, the IP address may be changed automatically.

## Step 2: Using a Driver to Set the Department ID and PIN

When Department ID Management is enabled on the machine, set the Department ID and PIN by specifying the printer driver. ▶ **Setting the Department ID and PIN on a Computer(P. 199)**

\* You can skip this step when not using Department ID Management. Proceed to Step 3.

## Step 3: Configuring the Option Settings of the Machine Using the Driver

When optional equipment is installed to the machine, you must configure the option settings in the printer driver in advance.

In Windows, normally, the option settings are configured automatically when the printer driver is installed.

Use the following procedure to configure the option settings when the option settings have not been configured at installation, optional equipment has been installed after installation of the printer driver, or when using macOS.

- ▶ **When Using Windows(P. 139)**
- ▶ **When Using macOS(P. 139)**

## ■ When Using Windows

Administrator privileges are required on each computer.

- 1 Log on to the computer using an administrator account.**
- 2 Click [Start] (Start) ▶ [Settings] (Settings) ▶ [Devices] ▶ [Printers & scanners].**
  - ⇒ The [Printers & scanners] screen is displayed.
- 3 Click the printer driver of the machine ▶ [Manage] ▶ [Printer properties].**
  - ⇒ The printer driver properties screen is displayed.
- 4 On the [Device Settings] tab, click [ ] in [Device information].**
  - ⇒ The [Confirmation] screen is displayed.
- 5 Click [Yes].**
  - ⇒ The option settings are obtained.
- 6 Click [OK] ▶ [OK].**
  - ⇒ The settings are applied.

## NOTE

### When [Could not get device information.] Appears

- Specify the option settings manually. For more information on how to configure the option settings manually, click [Help] on the [Device Settings] tab to display help.

## ■ When Using macOS

- 1 Click [Apple] ▶ [System Preferences] ▶ [Printers & Scanners].**
  - ⇒ The [Printers & Scanners] screen is displayed.
- 2 Select the machine, and click [Options & Supplies].**
- 3 On the [Utility] tab, click [Open Printer Utility].**
  - ⇒ The [Office Printer Utility] screen is displayed.

#### **4 Click [Printer Information].**

⇒ The option information is obtained, and the [Printer Information] screen is displayed.

#### **5 Click [OK].**

⇒ The settings are applied.

## **NOTE**

### **When the Option Information Cannot Be Obtained**

- Specify the option settings manually. For details about configuring the option settings manually, see the manual of the driver at the online manual site.  
<https://oip.manual.canon/>

# Configuring a Printer Port (Windows)

9664-038

If the IP address of the machine changed or a printer has been added in Windows, you may not be able to print from a computer. In this case, use the printer driver to add a new port.

In addition, you cannot print from a computer when the port number of the printer driver differs from that of the machine setting. In this case, change the setting on the printer driver to match that of the machine.

▶ **Adding a Port(P. 141)**

▶ **Changing the Port Type and Number(P. 142)**

## Adding a Port

Administrator privileges are required on each computer.

### Required Preparations

- Prepare the information of the IP address or DNS name (host name) of the machine and keep it close by. ▶ **Checking the Network Status and Settings(P. 76)**

**1 Log on to the computer using an administrator account.**

**2 Click [Start] ▶ [Settings] ▶ [Devices] ▶ [Printers & scanners].**

⇒ The [Printers & scanners] screen is displayed.

**3 Click the printer driver of the machine ▶ [Manage] ▶ [Printer properties].**

⇒ The printer driver properties screen is displayed.

**4 On the [Ports] tab, click [Add Port].**

⇒ The [Printer Ports] screen is displayed.

**5 Add a new port.**

**1** Select [Standard TCP/IP Port], and click [New Port].

⇒ The [Add Standard TCP/IP Printer Port Wizard] screen is displayed.

**2** Click [Next].

**3** Enter the IP address or DNS name (host name), and then click [Next].

The port name is entered automatically, so change it, as needed.

### When [Additional port information required] Appears

Take action following the instructions on the screen. To set [Device Type], select [Canon Network Printing Device with P9100] in [Standard].

## 6 Click [Finish].

⇒ A new port is added, and the [Printer Ports] screen is displayed.

## 7 Click [Close] ► [Close].

## Changing the Port Type and Number

If the machine is configured not to use LPD or RAW, you must change the type of port on the computer to a protocol usable on the machine.

If the LPD or RAW port number was changed, the settings on the computer may have to be changed to match the settings on the machine.

\* You do not need to change the port type or number on the computer for WSD ports.

Administrator privileges are required on each computer.

## 1 Log on to the computer using an administrator account.

## 2 Click [Start] ► [Settings] ► [Devices] ► [Printers & scanners].

⇒ The [Printers & scanners] screen is displayed.

## 3 Click the printer driver of the machine ► [Manage] ► [Printer properties].

⇒ The printer driver properties screen is displayed.

## 4 On the [Ports] tab, click [Configure Port].

⇒ The [Configure Port] screen or [Configure Standard TCP/IP Port Monitor] screen is displayed.

## 5 Set the port type and number.

In [Protocol Type], select [Raw] or [LPR].

- When [Raw] is selected, change the port number.
- When [LPR] is selected, enter "Ip" for [Queue Name].

## 6 Click [OK] ► [Close].

▣► The settings are applied.

## Setting Up a Print Server

9664-039

By setting up a print server on the network, you can speed up print operations on a computer, thereby reducing the load on the computer.

In Windows, you can install the printer driver via the print server to save you the trouble of downloading the printer driver to each computer on the network or using a CD/DVD-ROM.

To set up a print server, enable the print server to print from the machine, and then configure the settings for sharing the printer.

To use a print server in a domain environment, consult your network administrator..

▶ **Enabling the Print Server to Print from the Machine(P. 144)**

▶ **Configuring the Settings for Sharing the Printer(P. 144)**

### Enabling the Print Server to Print from the Machine

Install the printer driver to the computer that will be the print server, and configure the settings according to your usage environment. ▶ **Preparing to Print from a Computer(P. 138)**

#### Using a Print Server While Using Department ID Management

You must install Canon Driver Information Assist Service when installing the printer driver. For more information, see the manual of the driver at the online manual site.

<https://oip.manual.canon/>

### Configuring the Settings for Sharing the Printer

Configure the printer sharing settings on the computer that will be the print server so that other computers on the network can use the print server.

▶ **When Using Windows(P. 144)**

▶ **When Using macOS(P. 146)**

#### ■ When Using Windows

Administrator privileges are required on the computer that will be the print server.

#### Required Preparations

- Check the operating system (32-bit or 64-bit) of the computer that will be the print server and the operating system of the computer that will use the print server (the client). ▶ **Viewing the System Information of the Computer(P. 473)**

**1** Log on to the computer that will be the print server, using an administrator account.

**2** Click [ ] (Start) ▶ [ ] (Settings) ▶ [Devices] ▶ [Printers & scanners].

⇒ The [Printers & scanners] screen is displayed.

**3** Click the printer driver of the machine ▶ [Manage] ▶ [Printer properties].



⇒ The printer driver properties screen is displayed.

#### 4 On the [Sharing] tab, select the [Share this printer] checkbox, and enter a shared name.

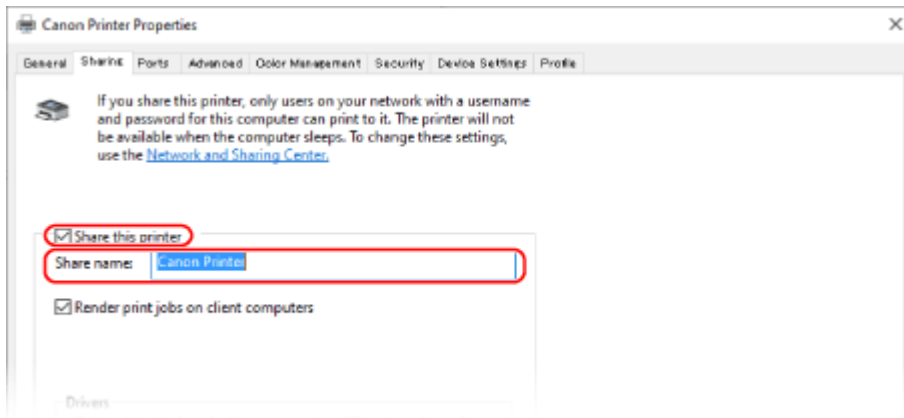

#### 5 Install an additional driver, as needed.

If the client computer has an operating system (32-bit or 64-bit) that differs from that of the print server, install an additional driver.

##### 1 Click [Additional Drivers].

⇒ The [Additional Drivers] screen is displayed.

##### 2 Select the checkbox of the driver to be added, and click [OK].

- If the print server computer has a 32-bit operating system, select the [x64] (driver for 64-bit version) checkbox.
- If the print server computer has a 64-bit operating system, select the [x86] (driver for 32-bit version) checkbox.

##### 3 Click [Browse], specify the folder where the driver is located, and click [OK].

##### When Specifying the Folder of the Downloaded Driver

- If the print server computer has a 32-bit operating system, specify the [x64] folder with the decompressed driver ► [Driver] folder.
- If the print server computer has a 64-bit operating system, specify the [32BIT] folder with the decompressed driver ► [Driver] folder.

##### When Specifying the Folder in the Supplied CD/DVD-ROM

- If the print server computer has a 32-bit operating system, specify [intdrv] in the CD/DVD-ROM ► [UFRII] ► [x64] ► [Driver] folder.
- If the print server computer has a 64-bit operating system, specify [intdrv] in the CD/DVD-ROM ► [UFRII] ► [32BIT] ► [Driver] folder.

##### 4 Install the additional driver while following the instructions on the screen.

#### 6 Click [OK].

⇒ The settings are applied.

## ■ When Using macOS

### **1** Click [ ] ▶ [System Preferences] ▶ [Sharing].

⇒ The [Sharing] screen is displayed.

### **2** Select the [Printer Sharing] checkbox.

### **3** In [Printers], select the checkbox of the machine.

### **4** Restrict the users that can use the print server, as needed.

By default, all users can use the print server.

To enable specific users to use the print server, click [+] under [Users], and select the users who can use the print server.

### **5** Close the [Sharing] screen.

⇒ The settings are applied.

# Preparations for Using Universal Print

---

9664-03A

Configure the machine to be able to use Microsoft's cloud service, Universal Print, and register the machine to each computer that will be used to print.

You must be a registered user of Microsoft 365 and use Azure Active Directory.

▶ **Registering the Machine to Cloud Service(P. 148)**

▶ **Registering the Machine to the Computer(P. 151)**

# Registering the Machine to Cloud Service

Register the machine to the cloud-based authentication and management service, Azure Active Directory, and set the members or groups that will use the machine.

- ▶ **Step 1: Registering the Machine to Azure Active Directory(P. 148)**
- ▶ **Step 2: Specifying the Members and Groups to Use the Machine(P. 150)**

## Step 1: Registering the Machine to Azure Active Directory

Configure this setting using Remote UI from a computer. You cannot use the control panel to configure the settings.

Administrator privileges are required.

**1 Log in to Remote UI in System Manager Mode. ▶ Starting Remote UI(P. 256)**

**2 On the Portal page of Remote UI, click [Settings/Registration]. ▶ Portal Page of Remote UI(P. 259)**

**3 Click [Network Settings] ▶ [Universal Print Settings].**

⇒ The [Universal Print Settings] screen is displayed.

**4 Click [Edit] in [Basic Settings].**

**5 Select the [Use Universal Print] checkbox, and enter the printer name.**

- For the printer name, enter a name to identify the machine, using single-byte alphanumeric characters.
- To verify the certificate sent from the server, select the [Verify Server Certificate] checkbox. To add a Common Name (CN) to the verification items, select the [Add CN to Verification Items] checkbox as well.

**6 Change Application ID and the URL of Azure Active Directory according to usage environment.**

**7 Click [OK].**

⇒ The [Universal Print Settings] screen is displayed.

**8 Click [Register] in [Registration Status].**

⇒ The [Information for Registration] screen is displayed.

**9** Wait several seconds, and then click [↻].

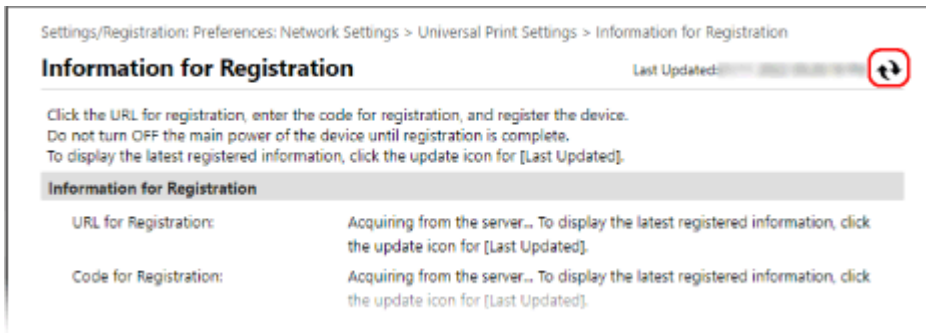

**10** Click the link displayed in [URL for Registration].

**11** Register the machine according to the instructions on the screen.

**12** Click [Universal Print Settings] at the top of the Remote UI screen.

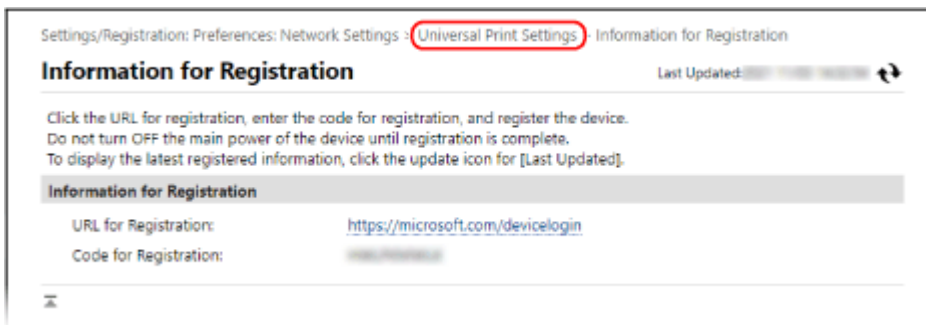

⇒ The [Universal Print Settings] screen is displayed.

**13** Wait a few minutes, and then click [↻].

⇒ When registration is complete, [Registered] is displayed in [Registration Status].

**14** Log out from Remote UI.

**NOTE**

**Canceling the Registration**

- Click [Unregister] on the [Universal Print Settings] screen ► [OK]. On the Azure Active Directory device management screen, select the machine and click [Delete].

## Step 2: Specifying the Members and Groups to Use the Machine

- 1 Display the Universal Print management screen of Azure Active Directory in a Web browser on a computer.**
- 2 Select the machine, and click [Share Printer].**

To change the name of the machine displayed on the computer, change [Printer Share Name].
- 3 Click [Members] ► [Add].**
- 4 From the list, select the members and groups who will use the printer.**

# Registering the Machine to the Computer

9664-03E

Register the machine, which is registered to Azure Active Directory, to the computer to be used for Universal Print.

## Required Preparations

- Register the machine to Azure Active Directory. ▶ [Registering the Machine to Cloud Service\(P. 148\)](#)

### 1 Click [Start] (Start) ▶ [Settings] (Settings) ▶ [Accounts].

⇒ The [Your info] screen is displayed.

### 2 Click [Access work or school] ▶ [Connect].

### 3 Follow the on-screen instructions to sign in to your Microsoft 365 account.

### 4 Click [Home] ▶ [Devices] ▶ [Printers & scanners].

⇒ The [Printers & scanners] screen is displayed.

### 5 Click [Add a printer or scanner].

⇒ The printer list screen is displayed.

### 6 Select the machine and click [Add device].

⇒ The machine is registered to the computer.

## NOTE

### When Using a Proxy Server

- To use Universal Print via a proxy server, you must configure the proxy settings on each computer. For details, contact the network administrator.

# Preparing to Receive and Print I-Faxes

9664-03H

Configure the information of the e-mail server to use for receiving and printing data by I-Fax (Internet Fax). You can also configure APOP authentication and encryption communication settings.

This section describes how to configure the settings using Remote UI from a computer. You cannot use the control panel to configure the settings.

Administrator privileges are required. The machine must be restarted to apply the settings.

If the port number of the e-mail server (POP3 server) is other than 110, you must change the port number setting. [▶](#)  
**Changing the Port Number(P. 206)**

## Required Preparations

- Connect the computer you are using to configure the settings to the machine over a network.
- Prepare the following information and keep it close by.
  - IP address of the machine [▶](#)**Checking the Network Status and Settings(P. 76)**
  - Setting information of the e-mail server (POP3 server name, user name, and password to be used for authentication, encrypted communication setting)
    - \* For details about the setting information, contact your provider or network administrator. Depending on the usage environment, you can also refer to the information set in the computer e-mail software.

**1 Log in to Remote UI in System Manager Mode. [▶](#)Starting Remote UI(P. 256)**

**2 On the Portal page of Remote UI, click [Settings/Registration]. [▶](#)Portal Page of Remote UI(P. 259)**

**3 Click [Network Settings] ▶ [E-Mail Settings] ▶ [Edit].**

⇒ The [Edit E-Mail Settings] screen is displayed.

**4 Enter the basic settings of the e-mail server.**

### [POP Server]

Enter the POP3 server name (the host name or IP address) using single-byte alphanumeric characters.

**Input example:** Host name  
pop.example.com

### [User Name]

Enter the user name used for authenticating the POP3 server using single-byte alphanumeric characters.

### [Set/Change Password]

To set a password to use when authenticating the POP3 server, select this checkbox, and enter the password using single-byte alphanumeric characters.

### [POP RX]

Select this checkbox.

### [POP Interval]

Enter the interval at which to connect automatically to the POP3 server to receive I-Faxes.  
To not receive I-Faxes automatically, enter [0]. In this case, I-Faxes must be manually received.



## **5 Configure the APOP authentication and encryption settings according to your usage environment.**

### **■ To Use APOP Authentication to Encrypt Password at Authentication**

Select the [Use APOP Authentication] checkbox.

### **■ To Encrypt Communication with the POP3 Server**

Select the [Use TLS for POP] checkbox.

## **6 Click [OK].**

By clicking [Check POP Connection], you can check the connection with the POP3 server using the current settings.

## **7 Restart the machine. ▶ Restarting the Machine(P. 87)**

⇒ The settings are applied.

# Printing from a Computer

9664-03J

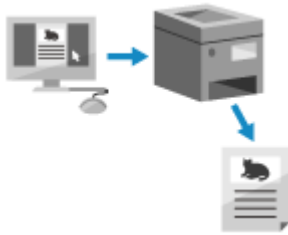

You can print documents from a computer using a printer driver. By changing the settings on the printer driver, you can print according to the document and purpose, such as by using 2-sided printing or adjusting the quality.

This section describes the general procedure for this operation. Check the manual of the application you are using for detailed operations on how to use it.

## Required Preparations

- Install the printer driver on the computer, and configure the settings according to your usage environment.
  - ▶ **Preparing to Print from a Computer(P. 138)**
- If the document or paper to print is a non-standard size, register the size to the printer driver. ▶ **Registering Non-standard Size Paper to the Computer (Custom Size)(P. 157)**

▶ **When Using Windows(P. 154)**

▶ **When Using macOS(P. 155)**

## ■ When Using Windows

- 1 On your computer, open the document you want to print.**
- 2 In the application used to open the document, select the command to print.**
- 3 Select the printer driver of the machine, and click [Preferences] or [Properties].**
  - ⇒ The [Printing preferences] screen of the printer driver is displayed.
- 4 In [Page Size] on the [Basic Settings] tab, select the paper size of the document.**

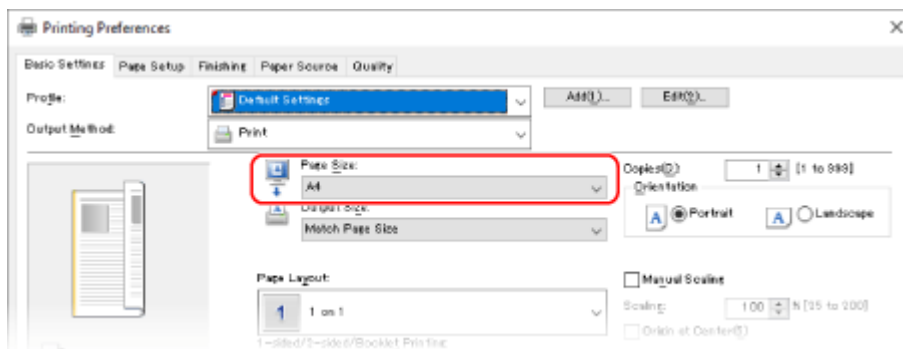

■ **When Printing on Paper of a Size Different from [Page Size]**

In [Output Size], select the paper size to print on. The document is enlarged or reduced to match the paper size in [Output Size].

**5 Configure the other print settings, as needed.**

Configure 2-sided printing and adjust the image quality and other settings to suit your document and purpose. For more information, click [Help] on the [Printing preferences] screen to display help.

**6 Click [OK], and click [Print] or [OK].**

⇒ Printing starts.

- You can cancel printing on the printing screen or from the printer icon in the Windows notification area. ▶ **Canceling Printing from a Computer(P. 167)**
- Use [Status Monitor] to view the print job status and log. ▶ **Viewing the Print Job Status and Log(P. 169)**

■ **When Using macOS**

**1 On your computer, open the document you want to print.**

**2 From the menu in the application used to open the document, click [Print].**

⇒ The printing dialog box appears.

**3 In [Printer], select the printer driver of the machine.**

**4 In [Paper Size] of the print options, select the paper size of the document.**

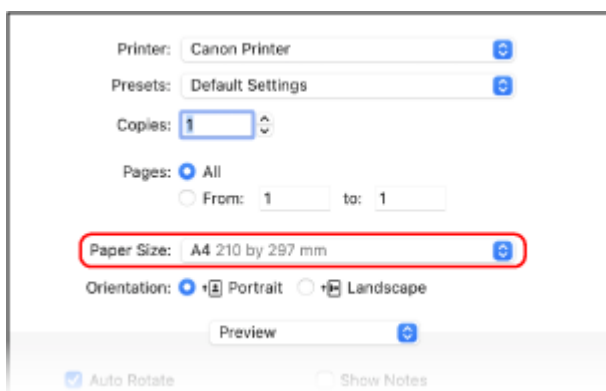

If print options are not displayed, click [Show Details] in the printing dialog box.

■ **When Printing on Paper of a Size Different from [Paper Size]**

**1 From the print options pop-up menu, select [Paper Handling].**

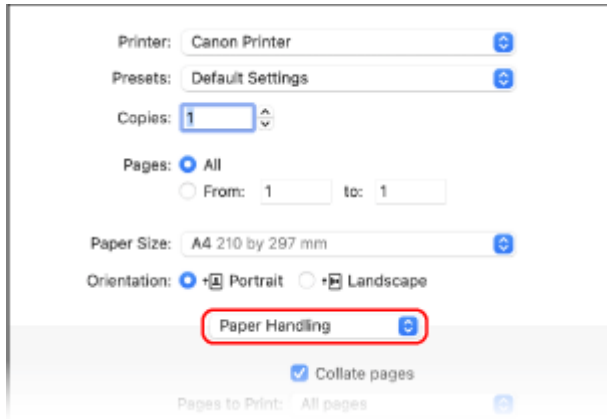

- 2 Select the [Scale to fit paper size] checkbox, and in [Destination Paper Size], select the paper size to print on.

The document is enlarged or reduced to match the paper size in [Destination Paper Size].

## 5 Configure the other print settings, as needed.

Configure 2-sided printing and adjust the image quality and other settings to suit your document and purpose. For more information, click [ ? ] in the printing dialog box to display help.

## 6 Click [Print].

⇒ Printing starts.

- You can cancel printing from the printer icon in the Dock. ▶ **Canceling Printing from a Computer(P. 167)**
- Use [Status Monitor] to view the print job status and log. ▶ **Viewing the Print Job Status and Log(P. 169)**

# Registering Non-standard Size Paper to the Computer (Custom Size)

9664-03K

Custom size paper is non-standard size paper whose side lengths can be freely defined.

If the document or paper to print is a non-standard size, you must register the size to the printer driver in advance.

▶ When Using Windows(P. 157)

▶ When Using macOS(P. 157)

## ■ When Using Windows

**1** Click [ ] (Start) ▶ [ ] (Settings) ▶ [Devices] ▶ [Printers & scanners].

⇒ The [Printers & scanners] screen is displayed.

**2** Click the printer driver of the machine ▶ [Manage] ▶ [Printing preferences].

⇒ The [Printing preferences] screen of the printer driver is displayed.

**3** On the [Page Setup] tab, click [Custom Paper Size].

**4** Enter the custom size paper name and paper size, and click [Register].

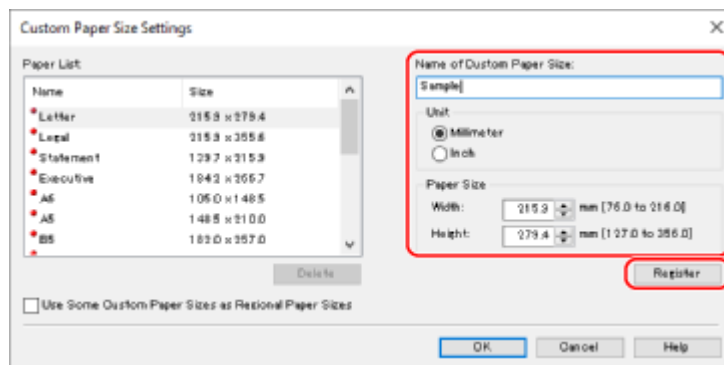

**5** Click [OK] ▶ [OK].

⇒ The custom size paper is registered.

## ■ When Using macOS

**1** On your computer, open the document you want to print.

**2** From the menu in the application used to open the document, click [Print].

⇒ The printing dialog box appears.

**3** In [Printer], select the printer driver of the machine.

**4** In [Paper Size] of the print options, select [Manage Custom Sizes].

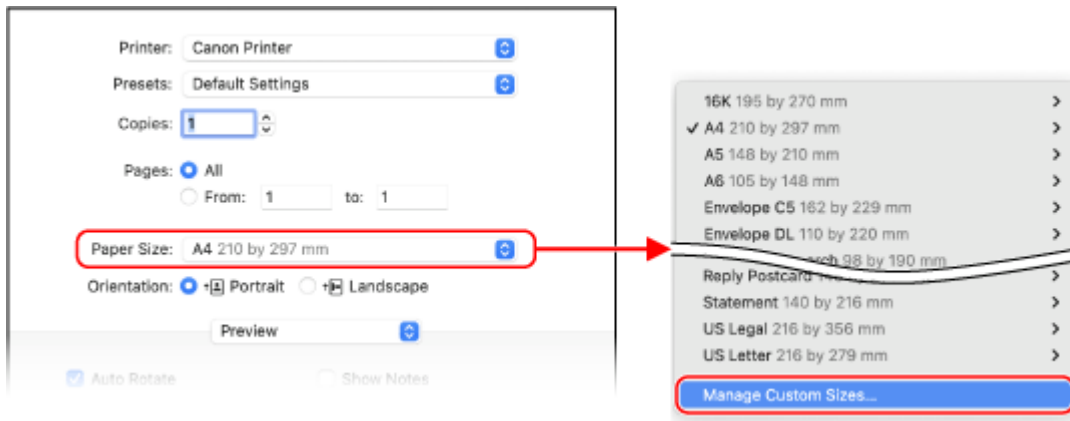

If print options are not displayed, click [Show Details] in the printing dialog box.

**5** Click [+] at the bottom left, double-click [Untitled], and enter the custom size paper name.

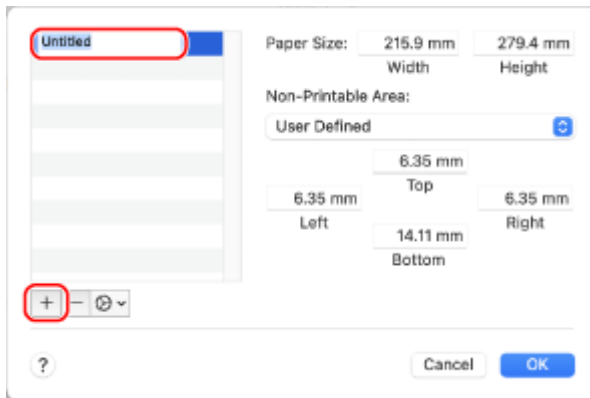

**6** Enter the paper size, and click [OK].

⇒ The custom size paper is registered.

# Printing a Document Secured with a PIN (Secure Print)

9664-03L

With Secure Print, you can set a PIN to a document on the computer and send that document to the machine to be printed. Printing is performed after that PIN is entered on the machine. Secure Print can prevent unattended printed documents and information theft. You can also confirm the print data before printing to prevent unwanted printing.

The print data sent with a PIN (secure data) is temporarily saved in the memory of the machine. If printing is not performed after a set period of time, the secure data is deleted automatically from the memory, and you can no longer print the data.

▶ **Step 1: Sending Secure Data from a Computer(P. 159)**

▶ **Step 2: Printing Secure Data by Entering a PIN or Password(P. 161)**

## NOTE

- You can change the period of time that the secure data is saved. ▶ **Changing the Time Period That Print Data with a PIN (Secure Data) Is Saved(P. 162)**

## Step 1: Sending Secure Data from a Computer

You can send secure data from a computer to the machine using a printer driver.

In Windows, you can send encrypted secure data (using Encrypted Secure Print), thereby preventing eavesdropping during communication. Secure data is encrypted with an alphanumeric password instead of a PIN. For details about sending secure data using the Encrypted Secure Print function, see the manual of the driver at the online manual site.

<https://oip.manual.canon/>

▶ **When Using Windows(P. 159)**

▶ **When Using macOS(P. 160)**

### ■ When Using Windows

This section describes how to send regular secure data.

**1** Display the [Printing preferences] screen of the printer driver. ▶ **Printing from a Computer(P. 154)**

**2** In [Output Method], select [Secured Print].

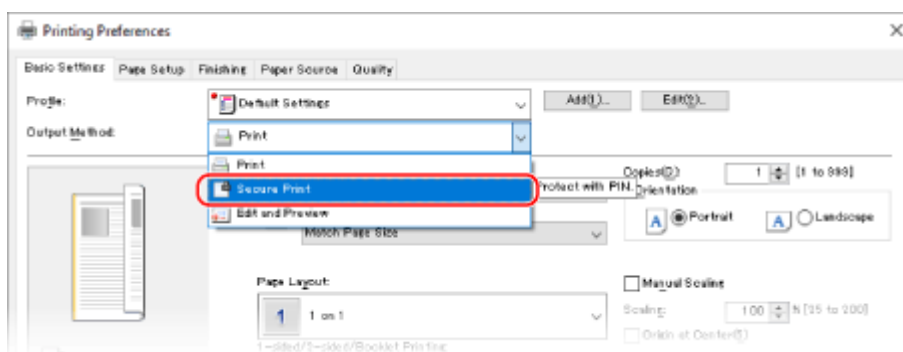

⇒ The [Information] screen is displayed.

### 3 Click [Yes].

⇒ The [Secured Print Details] screen is displayed.

### 4 Enter the user name and PIN, and click [OK].

⇒ The [Printing preferences] screen reappears.

### 5 Click [OK], and click [Print] or [OK].

⇒ The secure data is sent to the machine.

## ■ When Using macOS

### Required Preparations

- Enable Secure Print in the settings of the printer registered to the computer. ▶ **Enabling Secure Print in a Printer Driver (macOS)(P. 163)**

### 1 Display the printing dialog box, and select the printer driver of the machine. ▶ **Printing from a Computer(P. 154)**

### 2 From the print options pop-up menu, select [Special Features].

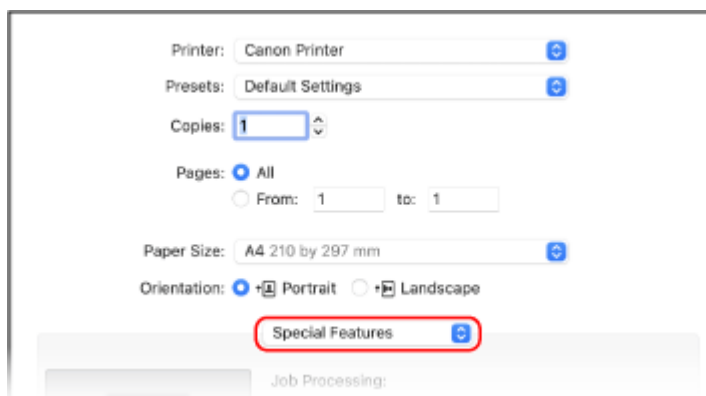

If print options are not displayed, click [Show Details] in the printing dialog box.

### 3 In [Job Processing], select [Secured Print].

### 4 Click [Print].

⇒ The [Secured Print] screen is displayed.

### 5 Enter the document name, user name, and PIN, and click [OK].



⇒ The secure data is sent to the machine.

## Step 2: Printing Secure Data by Entering a PIN or Password

Print the secure data sent to the machine. If the secure data is left without printing, it will remain in the memory of the machine, and you may not be able to print other data. Print the sent secure data as soon as possible.

### 1 On the control panel, select [Secure Print] in the [Home] screen, and press . [Home] Screen(P. 94)





⇒ The Secure Print screen is displayed.

If the screen for selecting the user is displayed, select your user name.

### 2 Select the secure data to print, and press .







### 3 Enter the PIN or password, and press .

⇒ Printing starts.

- If you selected multiple files of secure data in Step 2 above, only secure data that matches the entered PIN or password is printed.
- To cancel printing, press [<Cancel>] on the printing screen  .
- You can also cancel printing from [Status Monitor].  **Canceling Printing with the Control Panel(P. 168)**
- Use [Status Monitor] to view the print job status and log.  **Viewing the Print Job Status and Log(P. 169)**

## NOTE

- You can use the following procedure to view the memory usage of saved secure data.

On the control panel, press   [Device Status]    [Secure Print Memory Usage]  

# Changing the Time Period That Print Data with a PIN (Secure Data) Is Saved

---

9664-03R

You can change the period of time until the print data that was sent with a PIN or password (secure data) and is temporarily saved in the memory of the machine is deleted.

This section describes how to configure the settings using Remote UI from a computer.

On the control panel, select [Menu] in the [Home] screen, and then select [Function Settings] to configure the settings.

▶[Secure Print](P. 316)

Administrator privileges are required.

**1 Log in to Remote UI in System Manager Mode. ▶Starting Remote UI(P. 256)**

**2 On the Portal page of Remote UI, click [Settings/Registration]. ▶Portal Page of Remote UI(P. 259)**

**3 Click [Secure Print Settings] ▶ [Edit].**

⇒ The [Edit Secure Print Settings] screen is displayed.

**4 In [Secure Print Deletion Time], enter the period of time the secure data is saved (until it is deleted), and click [OK].**

⇒ The settings are applied.

**5 Log out from Remote UI.**

## Enabling Secure Print in a Printer Driver (macOS)

---

9664-03S

To send secure data from a macOS computer to the machine, you must enable Secure Print in the settings of the printer registered to the computer.

**1** Click [  ] ► [System Preferences] ► [Printers & Scanners].

► The [Printers & Scanners] screen is displayed.

**2** Select the machine, and click [Options & Supplies].

**3** On the [Options] tab, select the [Secured Print] checkbox, and click [OK].

► The settings are applied.

# Printing with Universal Print

---

9664-03U

Universal Print is a Microsoft service that enables you to print documents via the cloud. There is no need to install a printer driver to print documents from your computer. You can also print documents from a remote location as long as your computer is connected to the Internet.

To use Universal Print, you must be a registered user of Microsoft 365 and use Azure Active Directory.

## Required Preparations

- Register the machine to Azure Active Directory, and set the members or groups that will use the machine. ▶ **Registering the Machine to Cloud Service(P. 148)**
- To each computer that will use Universal Print, register the machine that is registered to Azure Active Directory. ▶ **Registering the Machine to the Computer(P. 151)**

For details about how to print with Universal Print and the supported operating systems, see the Microsoft website. <https://docs.microsoft.com/>

## Receiving and Printing I-Faxes

9664-040

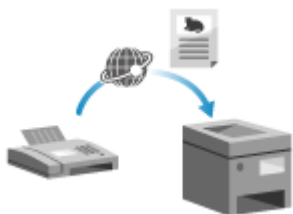

I-Fax (Internet Fax) is a function for sending and receiving faxes via the Internet. The machine cannot send I-Faxes, but it can receive and print I-Faxes.

The machine for sending I-Faxes must support I-Fax technology.

When there is an I-Fax, it is automatically received from the set mail server and then it is printed automatically once receiving is completed.

You can change the paper size to print and configure the settings to print on both sides of the paper. [▶ Changing the Print Settings of the Received I-Fax\(P. 166\)](#)

### Required Preparations

- On the machine, configure the settings of the e-mail server to be used to receive I-Faxes. [▶ Preparing to Receive and Print I-Faxes\(P. 152\)](#)

### ■ Manually Receiving I-Faxes

If you want to connect to the server before receiving I-Faxes automatically, or if the machine is set to not receive I-Faxes automatically, you can receive I-Faxes manually.

#### 1 Press on the control panel. [▶ Control Panel\(P. 14\)](#)

⇒ The [Status Monitor] screen is displayed.

#### 2 Press [RX Job] ▶ ▶ [Check I-Fax RX] ▶ .

⇒ The machine connects to the server. When you receive an I-Fax, printing starts automatically.

# Changing the Print Settings of the Received I-Fax

---

9664-041

Received I-Faxes are printed on A4 size paper on one side by default. You can change the settings to print on both sides and on different size paper.

This section describes how to configure the settings using Remote UI from a computer.

On the control panel, select [Menu] in the [Home] screen, and then select [Function Settings] to configure the settings.

▶ **[E-Mail Settings](P. 342)**

Administrator privileges are required.

**1 Log in to Remote UI in System Manager Mode.** ▶ **Starting Remote UI(P. 256)**

**2 On the Portal page of Remote UI, click [Settings/Registration].** ▶ **Portal Page of Remote UI(P. 259)**

**3 Click [RX Settings] ▶ [E-Mail Settings] ▶ [Edit].**

⇒ The [Edit E-Mail Settings] screen is displayed.

**4 Change the print settings.**

**[Print on Both Sides]**

Select this checkbox to print on both sides of the paper.

**[RX Print Size]**

Select the paper size for printing the received data.

**5 Click [OK].**

⇒ The settings are applied.

**6 Log out from Remote UI.**

## Canceling Printing

You can cancel printing from a computer. To cancel printing after the print data has been sent to the machine, use the control panel or Remote UI.

- ▶ **Canceling Printing from a Computer(P. 167)**
- ▶ **Canceling Printing with the Control Panel(P. 168)**
- ▶ **Canceling Printing with Remote UI(P. 168)**

### Canceling Printing from a Computer

- ▶ **When Using Windows(P. 167)**
- ▶ **When Using macOS(P. 167)**

#### ■ When Using Windows

If the printing screen is displayed, click [Cancel].



If the above screen is not displayed, double-click the printer icon in the Windows notification area, select the document to cancel, and click [Document] ▶ [Cancel] ▶ [Yes].

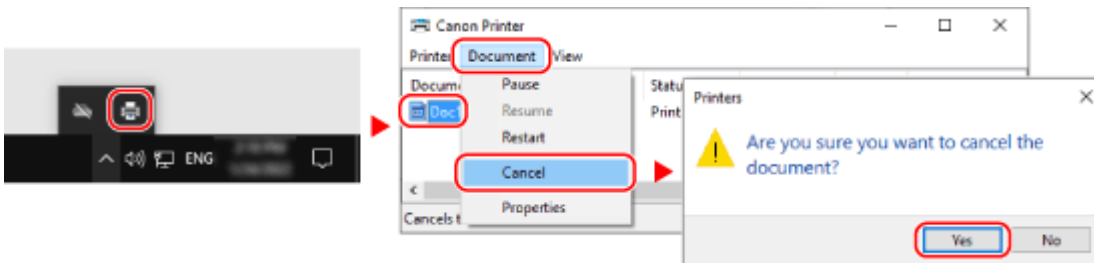

If the printer icon is not displayed in the Windows notification area or the document to be canceled is not displayed, the print data is sent to the machine after being processed on the computer.

In this case, cancel printing using the control panel of the machine or Remote UI. ▶ **Canceling Printing with the Control Panel(P. 168)**





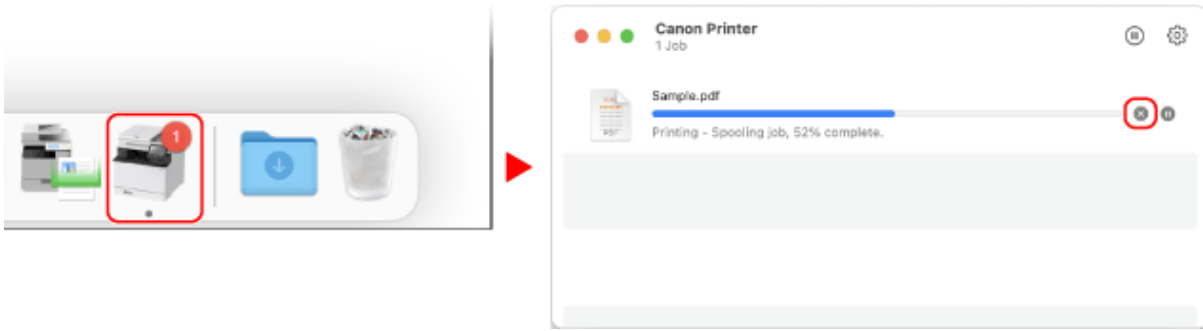







#### ■ When Using macOS

Click the printer icon in the Dock, select the document to cancel, and click [⌘].





## Canceling Printing with the Control Panel

You can cancel printing using the procedure below.

- 1** Press  on the control panel.  **Control Panel(P. 14)**
- 2** Press [Print Job]    [Job Status]  .
- 3** Select the job to be canceled in [Print Job Status], press .
- 4** Press [<Cancel>]    [Yes]  .

## Canceling Printing with Remote UI

You can cancel printing with [Status Monitor/Cancel]  [Job Status] screen in [Print] of Remote UI.  **Checking Usage and Logs with Remote UI(P. 261)**



# Viewing the Print Job Status and Log

9664-043

Processes handled by the machine, including printing, are managed as jobs. By checking the status and log of jobs, you can determine whether a print job was performed correctly and the cause of errors that occurred.

\* If the log is set to not be displayed, you can only check the print job status. [▶\[Display Job Log\]\(P. 346\)](#)

This section describes how to view this information using the control panel.

You can also check this information using Remote UI from a computer. [▶Checking Usage and Logs with Remote UI\(P. 261\)](#)

**1** Press  on the control panel. [▶Control Panel\(P. 14\)](#)

**2** Select [Print Job], press , and check the print job status and log .

## ■Viewing the Print Job Status

**1** Select [Job Status], press .

**2** Select a job to view its details and press .

⇒ The job details are displayed.

**3** View the file name, user name, and other information.

Depending on the type of characters being used, the file name and user name may not be correctly displayed.

## ■Viewing the Print Job Log

**1** Select [Job Log], press .

**2** Select a job to view its details and press .

⇒ The job details are displayed.

**3** View the file name, user name, and other information.

Depending on the type of characters being used, the file name and user name may not be correctly displayed.

### If Print Job Log Displays Error Information

Printing was canceled, or an error occurred.

If a three-digit number starting with "#" (error code) is displayed, you can check the cause and solution using the error code. [▶An Error Code Is Displayed\(P. 458\)](#)

# Linking with Mobile Devices

<b>Linking with Mobile Devices</b> .....	171
<b>Preparations for Linking with Mobile Devices</b> .....	172
Preparations for Direct Connection .....	173
Preparations for Using AirPrint .....	175
<b>Connecting a Mobile Device to the Machine</b> .....	178
Connecting a Mobile Device via Wireless LAN Router (LAN Connection) .....	179
Connecting a Mobile Device Directly to the Machine (Direct Connection) .....	180
<b>Using a Dedicated Application to Print (Canon PRINT Business)</b> .....	182
<b>Using AirPrint Application to Print Data</b> .....	183
<b>Printing from an Android Device</b> .....	186
<b>Printing from Chromebook or Other Device with Chrome OS</b> .....	188

# Linking with Mobile Devices

9664-044

The machine can be operated from a smartphone, tablet, or other mobile device. By using a compatible application or service, you can easily print photos or documents through a mobile device.

The applications and services that are available vary depending on the mobile device you are using.

## iPhone, iPad, iPod touch, Mac

### Canon PRINT Business (iPhone, iPad only)

Dedicated Canon application. It also supports Department ID Management.

▶ **Using a Dedicated Application to Print (Canon PRINT Business)(P. 182)**

### AirPrint

This function is standard in Apple operating systems. You can print from applications that support AirPrint instead of having to install a dedicated application or driver.

In addition, you can use AirPrint to print from a Mac.

▶ **Preparations for Using AirPrint(P. 175)**

▶ **Using AirPrint Application to Print Data(P. 183)**

## Android Devices

### Canon PRINT Business

Dedicated Canon application. It also supports Department ID Management.

▶ **Using a Dedicated Application to Print (Canon PRINT Business)(P. 182)**

### Canon Print Service

Dedicated Canon plugin. Enables printing from any application. It also supports Department ID Management.

▶ **Using a Dedicated Plugin to Print (Canon Print Service)(P. 186)**

### Mopria® Print Service

Common plugin for Mopria® certified printers and multifunction machines. Enables printing from any application without having to install a dedicated plugin or application for individual manufacturers.

▶ **Using a Common Plugin to Print (Mopria® Print Service)(P. 186)**

## Chromebook or Other Device with Chrome OS

You can use the function standard equipped in the Chrome operating system to print without having to install a dedicated application or printer driver.

▶ **Printing from Chromebook or Other Device with Chrome OS(P. 188)**

## IMPORTANT

### When Applying a Security Policy

- When [Restrict IPP Port (Port Number: 631)] or [Restrict mDNS Port (Port Number: 5353)] is enabled, you cannot use AirPrint and Mopria® Print Service. ▶ **Security Policy Items(P. 248)**

## ■ See Also

### Managing the Machine from a Mobile Device (Remote UI)

You can use Remote UI from a Web browser on a mobile device. With Remote UI, you can check the operation status of the machine and change the machine settings. For details about starting and operating Remote UI, see the instructions for using Remote UI on a computer.

▶ **Managing the Machine from a Computer (Remote UI)(P. 255)**

\* Some display items are omitted in the mobile version of Remote UI. To check all items, tap [PC Version] at the bottom of the screen and switch to the computer version of Remote UI.

## Preparations for Linking with Mobile Devices

---

9664-045

To directly connect a mobile device to the machine or to use AirPrint, you must first configure the settings on the machine.

- ▶ **Preparations for Direct Connection(P. 173)**
- ▶ **Preparations for Using AirPrint(P. 175)**

# Preparations for Direct Connection

9664-046

Enable the Direct Connection function on the machine. If the machine is not connected to a network, you need to check the Network Connection Type settings.

- ▶ **Enabling the Direct Connection Function(P. 173)**
- ▶ **Checking the Network Connection Type of the Machine(P. 174)**

## Enabling the Direct Connection Function

This section describes how to configure the settings using Remote UI from a computer.

On the control panel, select [Menu] in the [Home] screen, and then select [Preferences] to configure the settings. ▶ **[Direct Connection Settings](P. 288)**

Administrator privileges are required. The machine must be restarted to apply the settings.

- 1 Log in to Remote UI in System Manager Mode. ▶ Starting Remote UI(P. 256)**
- 2 On the Portal page of Remote UI, click [Settings/Registration]. ▶ Portal Page of Remote UI(P. 259)**
- 3 Click [Network Settings] ▶ [Direct Connection Settings] ▶ [Edit].**
  - ⇒ The [Edit Direct Connection Settings] screen is displayed.
- 4 Select the [Use Direct Connection] checkbox.**
- 5 Configure the Direct Connection function, as needed.**

When connecting multiple mobile devices at the same time, you must specify the SSID and network key.

### ■ To Terminate the Connection Automatically

Select the [Terminate Direct Connection Session] checkbox, and enter the time period of the direct connection until it is terminated. When multiple mobile devices are connected, they will be disconnected after the time period elapses since the last started connection.

### ■ To Change the IP Address for Connection

In [IP Address for Direct Connection], enter any IP address.

### ■ To specify the SSID and Network Key (When Connecting Multiple Mobile Devices at the Same Time)

By default, the SSID and network key of the machine are automatically assigned a random character string each time direct connection is performed.

To specify the SSID and network key manually, in [Access Point Mode Settings], select the [Specify SSID to Use] or [Specify Network Key to Use] checkbox, and enter an SSID or network key using single-byte alphanumeric characters.

### ■ To Allow Mobile Devices to Always Connect to the Machine

By default, you must use the control panel to put the machine into waiting state when you want to establish a direct connection.

To allow mobile devices to always connect to the machine, in [Access Point Mode Settings], specify the SSID and network key, and select the [Always Keep Enabled If SSID/Network Key Is Specified] checkbox in [Keep Connection Enabled].

**6** Click [OK].

**7** Restart the machine. ▶ **Restarting the Machine(P. 87)**

⇒ The settings are applied.

## Checking the Network Connection Type of the Machine

If the machine is not connected to a network (wired or wireless LAN), check that the network connection type is set to wired LAN.

If the machine is connected to a network, you do not have to check this.

**1** Press  on the control panel. ▶ **Control Panel(P. 14)**

⇒ The [Status Monitor] screen is displayed.

**2** Press [Network Information] ▶  ▶ [Network Connection Method] ▶ .

⇒ The [Network Conn. Method] screen is displayed.

**3** Check that [Wired LAN] is displayed.

If the connection type is set to wired LAN, you can establish a direct connection even if the machine is not connected to a network.

### ■ When [Wireless LAN] Is Displayed in [Network Conn. Method]

When the machine is not connected to a wireless LAN, a direct connection cannot be established. Connect the machine to a wireless LAN or switch the connection type to wired LAN.

▶ **Connecting to a Wireless LAN(P. 47)**

▶ **Selecting Wired or Wireless LAN(P. 45)**

# Preparations for Using AirPrint

9664-047

Set the basic information that is required to use AirPrint. Configure the settings related to the functions and security that will be used, according to your usage and environment.

- ▶ **Setting the Basic Information of AirPrint(P. 175)**
- ▶ **Setting the Functions and Security to Be Used with AirPrint(P. 176)**

## NOTE

### When Using Department ID Management

- Department IDs cannot be set with AirPrint. To use AirPrint while using Department ID Management, configure the settings so as not to restrict the following operations: ▶ **Enabling Department ID Management(P. 198)**
  - Printing from a computer with an unknown Department ID

## Setting the Basic Information of AirPrint

Configure these settings using Remote UI from a computer. You cannot use the control panel to configure the settings.

Administrator privileges are required.

- 1 Log in to Remote UI in System Manager Mode. ▶ Starting Remote UI(P. 256)**
- 2 On the Portal page of Remote UI, click [Settings/Registration]. ▶ Portal Page of Remote UI(P. 259)**
- 3 Click [Network Settings] ▶ [AirPrint Settings] ▶ [Edit].**

⇒ The [Edit AirPrint Settings] screen is displayed.

### **4 Select the [Use AirPrint] checkbox, and enter the printer name.**

- For the printer name, enter a name to identify the machine, using single-byte alphanumeric characters.
- If mDNS of IPv4 is set, the mDNS name is entered for the printer name. If you change the printer name, the mDNS name is also changed.

\* When you change the set printer name or mDNS name, the Mac that was connected to the machine may no longer be able to connect to it. In this case, you must register the machine on the Mac.

### **5 Enter the location and longitude and latitude of the machine, as needed.**

If the location of the machine is set in [Settings/Registration] ▶ [Device Management] ▶ [Device Information Settings], the same character string is entered in the location. When you change the location in AirPrint Settings, the location in Device Information Settings is also changed.

### **6 Click [OK].**

⇒ The settings are applied.

## 7 Log out from Remote UI.

### NOTE

- When the AirPrint function is enabled, the following network settings are also enabled:
  - ▶[Use HTTP](P. 300)
  - ▶[IPP Print Settings](P. 300)
  - ▶[mDNS Settings](P. 296)

## Setting the Functions and Security to Be Used with AirPrint

AirPrint uses the IPP protocol.

You can configure the settings to encrypt communication with TLS and configure IPP authentication when using the protocol.

Configure these settings using Remote UI from a computer. You cannot use the control panel to configure the settings.

Administrator privileges are required.

### Required Preparations

- When encrypting communication with TLS, specify the key and certificate to use for TLS encrypted communication. ▶Using TLS(P. 209)

### 1 Log in to Remote UI in System Manager Mode. ▶Starting Remote UI(P. 256)

### 2 On the Portal page of Remote UI, click [Settings/Registration]. ▶Portal Page of Remote UI(P. 259)

### 3 Click [Network Settings] ▶ [IPP Print Settings] ▶ [Edit].

⇒ The [Edit IPP Print Settings] screen is displayed.

### 4 Configure the IPP settings.

#### ■When Restricting the Functions to Use

Clear the [Use IPP Printing] checkbox.

When you clear the checkbox, printing with AirPrint is no longer possible.

#### ■When Encrypting Communication with TLS

Select the [Allow Only When Using TLS] or [Use TLS] checkbox.

#### ■When Setting IPP Authentication

Select the [Use Authentication] checkbox, and set the user name to be used for IPP authentication using single-byte alphanumeric characters.



To set a password, select the [Set/Change Password] checkbox, and enter the same password in both [Password] and [Confirm] using single-byte alphanumeric characters.

Printing with AirPrint now requires authentication, and only users who know the user name and password of IPP authentication can use these functions.

## **5 Click [OK].**

▣▣▣▣ The settings are applied.

## **6 Log out from Remote UI.**

## Connecting a Mobile Device to the Machine

---

9664-048

To use the machine from a mobile device, you must connect it to the machine using either of the following methods:

### Connecting via Wireless LAN Router (LAN Connection)

Connect a mobile device to the machine via a wireless LAN router in the same way as you connect a computer to the machine. By configuring a mobile device to connect automatically to the wireless LAN router, you do not need to manually connect it next time.

#### ▶ Connecting a Mobile Device via Wireless LAN Router (LAN Connection)(P. 179)



### Connecting Directly (Direct Connection)

Connect a mobile device directly to the machine via Wi-Fi. You can directly connect to the machine without using wireless LAN router. You must manually connect the mobile device each time you use the machine.

#### ▶ Preparations for Direct Connection(P. 173)

#### ▶ Connecting a Mobile Device Directly to the Machine (Direct Connection)(P. 180)



## Connecting a Mobile Device via Wireless LAN Router (LAN Connection)

---

9664-049

Connect a mobile device to the machine via a wireless LAN router in the same way as you connect a computer to the machine. By configuring a mobile device to connect automatically to the wireless LAN router, you do not need to manually connect it next time.



### Required Preparations

- Connect the machine to the network using wireless or wired LAN. ▶ **Setting Up the Network(P. 43)**
  - \* When using a wired LAN, check that a wireless LAN router is connected to the same network.
- Set an IPv4 address to the machine. ▶ **Setting IPv4 Addresses(P. 58)**

Connect the mobile device to either of the following wireless LAN routers:

- A wireless LAN router connected to the machine
- (When the machine is connected to a wired LAN) A wireless LAN router on the network connected to the machine

For details about how to connect a mobile device to a wireless LAN router, see the manual of the mobile device.

# Connecting a Mobile Device Directly to the Machine (Direct Connection)

9664-04A

Connect a mobile device directly to the machine via Wi-Fi. You can directly connect it to the machine without using wireless LAN router. You must manually connect the mobile device each time you use the machine. By default, only one mobile device can be directly connected to the machine at any one time. Setting a fixed SSID and network key enables you to connect up to five mobile devices at the same time.



To establish a direct connection, you must use the control panel to put the machine into waiting state and then connect it using the following method:

## Manually Configuring the Wi-Fi Settings

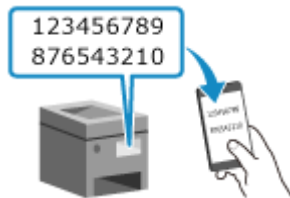

Search for the machine on the mobile device, and enter the network key manually to connect.

### Required Preparations

- Make preparations such as enabling the Direct Connection function on the machine. ▶ **Preparations for Direct Connection(P. 173)**

## 1 On the control panel, select [Mobile Portal] in the [Home] screen, and press **OK**.

[Home] Screen(P. 94)

⇒ The [Mobile Portal] screen is displayed.

## 2 Select [<Connect>] and press **OK**.

⇒ The machine enters waiting state for Direct Connection.

- Within 5 minutes of pressing [<Connect>], you must directly connect the mobile device.
- You can skip this step when [Connect from device you want to connect.] is displayed. Press **OK** and proceed to Step 3.
- When [Maximum number of wireless devices connected using Direct Connection has been reached.] is displayed, you cannot connect a new mobile device until a connected mobile device is disconnected. To disconnect a connected mobile device, press [<Disconnect>] ▶ **OK** ▶ [Yes] ▶ **OK**.

\* By default, only one mobile device can be directly connected to the machine at any one time.

## 3 Directly connect the mobile device.

## ■ Manually Configuring the Wi-Fi Settings

- 1 Check the SSID and network key of the machine.
- 2 In the Wi-Fi settings of the mobile device, select the SSID of the machine, and enter the network key. For details about how to configure the Wi-Fi settings, see the manual of the mobile device.

## 4 When [Connected.] appears on the control panel, press [Close].

⇒ The [Mobile Portal] screen reappears.

By default, only one mobile device can be directly connected to the machine at any one time. [Maximum number of wireless devices connected using Direct Connection has been reached.] is displayed on the screen.

## 5 When you have completed your operations on the mobile device, press [<Disconnect>] ▶ .

⇒ The direct connection is terminated.

If multiple mobile devices are connected, all devices are disconnected.

## IMPORTANT

- You may not be able to connect to the Internet with Direct Connection depending on the mobile device.
- The power-saving effect of sleep mode decreases when using Direct Connection.
- The IP address of the mobile device is set automatically. If you set the IP address manually, communication using Direct Connection may not be performed correctly.

## NOTE

### Checking a Mobile Device Connected to the Machine

- When using Direct Connection, press [Connection Info] to display the information of the mobile device connected to the machine with Direct Connection.

### If the Direct Connection Is Automatically Disconnected

- The direct connection is automatically terminated in the following cases:
  - When the Direct Connection Termination is set
  - When no data is sent or received between the mobile device and the machine for a while
  - When you are using the machine via a wireless LAN connection and the connection drops out

## Using a Dedicated Application to Print (Canon PRINT Business)

---

9664-04C

You can use the dedicated Canon application Canon PRINT Business to print. It also supports Department ID Management. Even when printing with an unknown Department ID is restricted, you can print by setting a Department ID.

### Compatible Operating Systems and Download Site

See the Canon website.

<https://global.canon/gomp/>

### Usage

- Connect a mobile device to the machine. ▶ **Connecting a Mobile Device to the Machine(P. 178)**
- Register the machine to Canon PRINT Business.  
When the mobile device is connected to the machine via LAN, the IP address information of the machine is required to register the machine to Canon PRINT Business.  
You can view the IP address with [Mobile Portal] on the control panel ▶ **OK** ▶ [Display Device Name/IP Address] ▶ **OK**.
- For details about registering the machine and printing, see the Help menu item in the application.

# Using AirPrint Application to Print Data

9664-04E

AirPrint is a print function standard in Apple operating systems. You can print from applications that support AirPrint instead of having to install a dedicated application or driver. In addition, you can use AirPrint to print from a Mac.



- ▶ **When Using an iPhone, iPad, or iPod touch(P. 183)**
- ▶ **When Using a Mac(P. 184)**

## ! IMPORTANT

### When Using Department ID Management on the Machine

- You cannot use AirPrint when printing from a computer with an unknown Department ID is restricted. ▶ **Enabling Department ID Management(P. 198)**

## When Using an iPhone, iPad, or iPod touch

Use AirPrint to print from an iPhone, iPad, or iPod touch connected to the machine via LAN or direct connection.

### Operating Environment

You can use AirPrint with the following iPhone, iPad, and iPod touch models:

- iPhone: 3GS or later
- iPad: All models
- iPod touch: Third generation or later

### Required Preparations

- Set the machine to enable use of AirPrint. ▶ **Preparations for Using AirPrint(P. 175)**
- Connect the machine to an iPhone, iPad, or iPod touch. ▶ **Connecting a Mobile Device to the Machine(P. 178)**

**1** Open the data to be printed on the iPhone, iPad, or iPod touch.

**2** In the application with the data to be printed open, tap [🖨️].

⇒ The menu options are displayed.

**3** Tap [Print].

⇒ The print options are displayed.

If print options are not displayed, the application does not support AirPrint. In this case, you cannot use AirPrint to print data.

#### 4 Tap [Printer], and select the machine.

#### 5 Configure the print settings.

The available settings and usable paper sizes vary depending on the application you are using.

#### 6 Tap [Print].

⇒ Printing starts.

Use [Status Monitor] on the control panel to view the print job status and log. ▶ **Viewing the Print Job Status and Log(P. 169)**

## When Using a Mac

You can use AirPrint to print data from a Mac connected to the network on the same LAN as the machine or a Mac connected to the machine via USB.

### Operating Environment

You can use AirPrint on a Mac with OS X 10.7 or later\*<sup>1</sup> installed.

\*<sup>1</sup> When printing from a Mac connected to the machine via USB, OS X 10.9 or later.

### Required Preparations

- Set the machine to enable use of AirPrint. ▶ **Preparations for Using AirPrint(P. 175)**
- Connect the machine to a Mac. ▶ **Setting Up the Network(P. 43)**  
When connecting via USB, connect to the USB port for computer connection on the back of the machine with a USB cable. ▶ **Rear Side(P. 12)**
- In [System Preferences] ▶ [Printers & Scanners] on the Mac, click [+] to register the machine.

### ▶ Using AirPrint to Print Data(P. 184)

#### ■ Using AirPrint to Print Data

#### 1 Open the document you want to print on your Mac.

#### 2 In the application used to open the document, click [Print].

⇒ The printing dialog box appears.

#### 3 In [Printer], select the machine.



## 4 Configure the print settings.

The available settings and usable paper sizes vary depending on the application you are using.

## 5 Click [Print].

▣▣▣▣ Printing starts.

Use [Status Monitor] on the control panel to view the print job status and log. [▶ Viewing the Print Job Status and Log\(P. 169\)](#)

## Printing from an Android Device

Install a plugin on a mobile device to enable printing from an application that has a print function. This machine supports Canon plugins as well as Mopria®, which is supported by various manufacturers.

- ▶ **Using a Dedicated Plugin to Print (Canon Print Service)(P. 186)**
- ▶ **Using a Common Plugin to Print (Mopria® Print Service)(P. 186)**

### Using a Dedicated Plugin to Print (Canon Print Service)

You can use the dedicated Canon plugin Canon Print Service to print from any application. It also supports Department ID Management. Even when printing with an unknown Department ID is restricted, you can print by setting a Department ID.

#### Compatible Operating Systems and Download Site

See the Canon website.

<https://global.canon/psmp/>

#### Usage

- Connect a mobile device to the machine. ▶ **Connecting a Mobile Device to the Machine(P. 178)**
- Register the machine to Canon Print Service.  
When the mobile device is connected to the machine via LAN, the IP address information of the machine is required to register the machine to Canon Print Service. You can view the IP address with [Mobile Portal] on the control panel ▶ **OK** ▶ [Display Device Name/IP Address] ▶ **OK**.
- For details about registering the machine and the printing method, see the Canon Print Service manual in "Mobile Apps" at the online manual site.

<https://oip.manual.canon/>

### Using a Common Plugin to Print (Mopria® Print Service)

The machine supports Mopria® Print Service, a plugin that enables printing from any application on a Mopria® certified printer or multifunction machine.

You can print on a Mopria® certified printer available from various manufacturers, which is convenient when printing on the go, without having to install a dedicated application or plugin.



#### Usage

- Connect a mobile device to the machine. ▶ **Connecting a Mobile Device to the Machine(P. 178)**
- For details about how to print and Mopria® certified printers, see the following website:

<https://mopria.org/>



### When Using Department ID Management on the Machine

- You cannot use Mopria® Print Service to print when printing from a computer with an unknown Department ID is restricted.  **Enabling Department ID Management(P. 198)**

# Printing from Chromebook or Other Device with Chrome OS

9664-04H

You can use a Chromebook or other device equipped with Chrome OS to print without having to install a dedicated application or printer driver.

## IMPORTANT

### Printing from a Chrome OS Device

- Printing from a Chrome OS device may not be supported depending on your country or region.

### When Using Department ID Management on the Machine

- You cannot print from a device equipped with Chrome OS when printing from a computer with an unknown Department ID is restricted. [▶ Enabling Department ID Management\(P. 198\)](#)

#### Usage

- Connect a Chromebook to the machine.
  - ▶ [Connecting a Mobile Device via Wireless LAN Router \(LAN Connection\)\(P. 179\)](#)  
When connecting via USB, connect to the USB port for computer connection on the back of the machine with a USB cable. [▶ Rear Side\(P. 12\)](#)
- For details about how to print using the Chromebook, see Chromebook Help.  
<https://support.google.com/chromebook/answer/7225252>

# Security

<b>Security</b> .....	190
<b>Setting the Department ID and PIN for the Administrator</b> .....	191
<b>Authenticating Users and Managing Groups</b> .....	193
Authenticating Users and Managing Groups with Department ID (Department ID Management) .....	194
Registering a Department ID and PIN .....	196
Enabling Department ID Management .....	198
Setting the Department ID and PIN on a Computer .....	199
Confirming Usage by Department ID .....	201
<b>Protecting the Network</b> .....	202
Setting the Firewall .....	203
Changing the Port Number .....	206
Using a Proxy .....	207
Using TLS .....	209
Using IPSec .....	211
Using IEEE 802.1X .....	215
Managing and Verifying a Key and Certificate .....	217
Generating a Key and Certificate .....	218
Generating a Key and Certificate Signing Request (CSR) and Obtaining and Registering a Certificate ...	220
Generating a Key and Obtaining and Registering a Certificate from an SCEP Server .....	223
If an Error Is Displayed in the Certificate Issuance Request Status .....	228
Registering a Key and Certificate or CA Certificate Obtained from an Issuing Authority .....	230
Verifying a Received Certificate with OCSP .....	232
<b>Preventing Leaking Information</b> .....	233
Restricting Use of Memory Media .....	234
Restricting Use from a Mobile Device .....	235
Restricting Printing .....	236
Restricting Printing from a Computer to Secure Print .....	237
<b>Preventing Unauthorized Use</b> .....	238
Restricting Use of Remote UI .....	239
Preventing Connection to Computer via USB Port .....	241
Configuring LPD, RAW, or WSD .....	242
Disabling HTTP Communication .....	244
Restricting Use of the Control Panel .....	245
<b>Applying a Security Policy</b> .....	246
Security Policy Items .....	248

# Security

---

9664-04J

This machine is an information device that uses communication functions and handles various data. Therefore, it is important to provide measures to prevent unauthorized access when using the machine in a network environment and measures against security risks such as leaking information.

This machine is equipped with various functions and settings to reduce these threats and vulnerabilities. Configure the settings and use them appropriately according to your usage environment and conditions for safer operation of the machine.

## **Creating an Administrator System**

Use an administrator account to manage the machine and configure the settings. Operate the machine using a system in which only a specific administrator(s) knows the ID and PIN.

▶ **Setting the Department ID and PIN for the Administrator(P. 191)**

## **Managing Users and Groups**

Managing the users and groups that use the machine and performing authentication of its use can prevent operation by third parties and unauthorized access.

▶ **Authenticating Users and Managing Groups(P. 193)**

## **Network Settings**

Applying the network security settings according to the usage environment can reduce the threat of unauthorized access and eavesdropping.

▶ **Protecting the Network(P. 202)**

## **Managing Usage Status**

Using a PIN and setting usage restrictions can help prevent unauthorized use of Remote UI. Implementing measures that include operations according to usage status of the machine can improve security.

▶ **Preventing Leaking Information(P. 233)**

▶ **Preventing Unauthorized Use(P. 238)**

## **Integrated Management Using a Security Policy**

Applying a security policy that exists for other devices to this machine can allow for sharing of the information security level within your organization.

▶ **Applying a Security Policy(P. 246)**

# Setting the Department ID and PIN for the Administrator

9664-04K

Set the System Manager ID and System Manager PIN to create an administrator account. By creating an administrator account, only those users who know these credentials can log in to System Manager Mode to view and change important settings. [System Manager ID and PIN\(P. 6\)](#)

This section describes how to configure the settings using the control panel. You can also configure the settings using Remote UI from a computer after the System Manager ID and PIN have been set on the machine. [Managing the Machine from a Computer \(Remote UI\)\(P. 255\)](#)  
Administrator privileges are required.

**1** On the control panel, select [Menu] in the [Home] screen, and press **OK**. [\[Home\] Screen\(P. 94\)](#)

**2** Press [Management Settings] **▶** **OK** **▶** [User Management] **▶** **OK** **▶** [System Manager Information Settings] **▶** **OK**.

⇒ The [Sys. Manager Info Set.] screen is displayed.

If the login screen appears, enter the currently set System Manager ID and PIN, and then press **ID**.

**3** Press [System Manager ID and PIN] **▶** **OK** **▶** enter the System Manager ID **▶** **OK**.

Specify any number. You cannot set a System Manager ID consisting of all zeros, such as "00" or "0000000."

**4** Enter the System Manager PIN, and press **OK**.

Specify any number other than "7654321." You cannot set a PIN consisting of all zeros, such as "00" or "0000000."

**5** Enter the PIN again, and press **OK**.

⇒ The settings are applied.

## IMPORTANT

- Do not forget the System Manager ID and PIN. If you forget your System Manager ID and PIN, contact your dealer or service representative. [If the Problem Persists\(P. 463\)](#)

## NOTE

### Setting the System Manager Information

- On the [Sys. Manager Info Set.] screen, press [System Manager Name] to set the name of the system manager.
- You can also configure the e-mail address and other system manager information by using Remote UI from a computer.

- The set information is displayed in [Status Monitor/Cancel] ► [Device Information] of Remote UI. ◀  
**Checking Usage and Logs with Remote UI(P. 261)**
- The set e-mail address becomes the destination that is selected by clicking [Mail to System Manager] on the Portal page of Remote UI. ◀**Portal Page of Remote UI(P. 259)**

### Clearing the System Manager ID and PIN Settings

- Clear the entered values of the System Manager ID and PIN, and then click [Apply] with the fields left empty.



# Authenticating Users and Managing Groups

---

9664-04L

Managing the users and groups that use the machine can prevent operation by third parties and unauthorized access.

## **Department ID Management**

Use Department ID Management to manage users for all functions of the machine. Only users who know the Department ID and PIN can use the machine. It is also possible to track usage of the machine by Department ID to help with managing costs.

▶ **Authenticating Users and Managing Groups with Department ID (Department ID Management)**  
**(P. 194)**

# Authenticating Users and Managing Groups with Department ID (Department ID Management)

9664-04R

Department ID Management is a function for managing users and groups by allocating a Department ID to each user or group.

When using Department ID Management, it is recommended to create an administrator account and a system for management and operation by a specific user.

## What You Can Do with Department ID Management(P. 194)

### Operation Examples(P. 194)

### Department ID Management Procedure(P. 195)

## What You Can Do with Department ID Management

By using Department ID Management, you can do the following:

### Enhance Security

- Set a PIN for Department ID to require authentication by entering the Department ID and PIN when a user logs in.
- Restrict operations for an unknown Department ID.

### Monitor Device Usage and Manage Costs

- Tally and keep track of the number of printed pages by Department ID.
- Set the maximum number of pages that can be printed by Department ID to control the number of sheets of paper that can be used.
- Restrict the functions of the machine by Department ID.

## Operation Examples

Assign Department IDs to users and groups according to usage environment and purpose. In addition, setting a PIN to a Department ID can prevent unauthorized access and enable stricter management.

### Example 1: Managing individual users by assigning them each a Department ID

Use this method to manage individual users by assigning them each a separate Department ID. This is useful when there are few people who use the machine and you want to limit the number of pages to be printed and function access for each user. Users log in with their own Department ID.

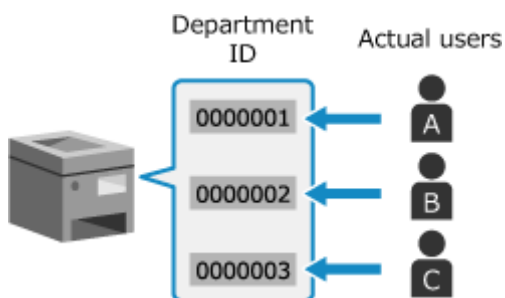

### Example 2: Managing users as a group

Use this method to manage multiple users in a group by assigning each group a separate Department ID. This is useful when there are many people or groups that use the machine, such as office departments and school classes.

Users log in with the Department ID of the group to which they belong.

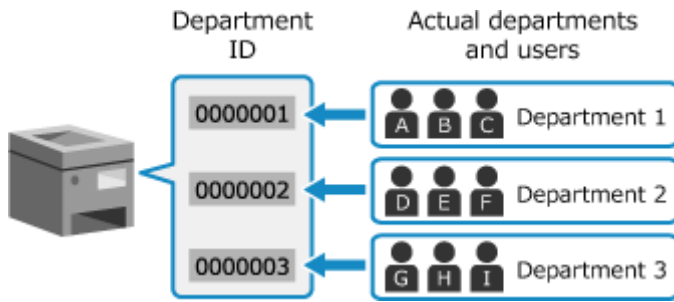

## Department ID Management Procedure

To use Department ID Management, follow the procedure below. Administrator privileges are required.

### Step 1

#### Set up Department ID Management.

- ▶ Setting the Department ID and PIN for the Administrator(P. 191)
- ▶ Registering a Department ID and PIN(P. 196)



### Step 2

#### Start Department ID Management.

Restrict operations for unknown Department IDs, as needed.

- ▶ Enabling Department ID Management(P. 198)



### Step 3

#### Set the Department ID and PIN on each computer using the machine.

- ▶ Setting the Department ID and PIN on a Computer(P. 199)



### Step 4

#### Perform Department ID Management.

- ▶ Confirming Usage by Department ID(P. 201)

# Registering a Department ID and PIN

9664-04S

Register the Department ID used by a group or user to be managed.

To perform authentication at login, set a PIN.

Limit the number of pages that can be printed and usable functions for each Department ID, as needed.

This section describes how to register a Department ID and PIN using Remote UI from a computer.

On the control panel, select [Menu] in the [Home] screen, and then select [Management Settings] to register this information. ▶ **[Department ID Management](P. 345)**

Administrator privileges are required.

## 1 Log in to Remote UI in System Manager Mode. ▶ Starting Remote UI(P. 256)

## 2 On the Portal page of Remote UI, click [Settings/Registration]. ▶ Portal Page of Remote UI(P. 259)

## 3 Click [User Management] ▶ [Department ID Management].

⇒ The [Department ID Management] screen is displayed.

## 4 Click [Register New Department].

⇒ The [Register New Department] screen is displayed.

## 5 In [New Department], set the Department ID and PIN.

- Enter numbers in [Department ID].
- To set a PIN, select the [Set PIN] checkbox, and enter the same number in [PIN] and [Confirm].

\* You cannot set a Department ID or PIN consisting of all zeros, such as "00" or "0000000."

## 6 Configure [Restrict Functions] as needed.

- To limit the number of pages that can be printed, select the desired item and enter the maximum number of pages in [Number of Pages].
- To restrict the usable functions, select the items you want to restrict.

## 7 Click [OK].

⇒ The registered Department ID is added to [Department ID Page Total] on the [Department ID Management] screen.

## 8 Log out from Remote UI.

### NOTE

### Editing a Registered Department ID

- To edit the registered information, click the Department ID you want to edit in [Department ID Page Total] on the [Department ID Management] screen.

# Enabling Department ID Management

---

9664-04U

After registering a Department ID, configure the settings to enable Department ID Management. Once Department ID Management is started, a login screen appears when operating the machine.

By default, printing from a computer can be operated without having to log in.  
You can also restrict the operation as needed.

This section describes how to configure the settings using Remote UI from a computer.  
On the control panel, select [Menu] in the [Home] screen, and then select [Management Settings] to configure the settings. [▶\[Department ID Management\]\(P. 345\)](#)  
Administrator privileges are required.

**1 Log in to Remote UI in System Manager Mode.** [▶Starting Remote UI\(P. 256\)](#)

**2 On the Portal page of Remote UI, click [Settings/Registration].** [▶Portal Page of Remote UI\(P. 259\)](#)

**3 Click [User Management] ▶ [Department ID Management] ▶ [Edit].**

⇒ The [Edit Department ID Management] screen is displayed.

**4 Select the [Department ID Management] checkbox.**

**5 To restrict printing from a computer with an unknown Department ID, clear the item.**

Clear the [Allow Print Jobs with Unknown IDs] checkbox.

\* When this checkbox is cleared, you must set the Department ID on the driver to be able to print or send faxes from a computer. [▶Setting the Department ID and PIN on a Computer\(P. 199\)](#)

**6 Click [OK].**

⇒ The settings are applied.

**7 Log out from Remote UI.**

# Setting the Department ID and PIN on a Computer

9664-04W

When restricting printing from a computer with an unknown Department ID, you must set the Department ID and PIN on each computer using the machine. If you want to include printing from a computer in the usage for each Department ID even when these are not restricted, set the Department ID and PIN for each computer.

🔗 **When Using Windows(P. 199)**

🔗 **When Using macOS(P. 200)**

## ■ When Using Windows

Administrator privileges are required on each computer.

**1 Log on to the computer using an administrator account.**

**2 Click [Start] (Start) ▶ [Settings] (Settings) ▶ [Devices] ▶ [Printers & scanners].**

⇒ The [Printers & scanners] screen is displayed.

**3 Click the driver of the machine ▶ [Manage] ▶ [Printer properties].**

⇒ The driver properties screen is displayed.

**4 On the [Device Settings] tab, set [User Management] to [Department ID Management].**

**5 Click [Settings] at the bottom right.**

⇒ The [Department ID/PIN Settings] screen is displayed.

**6 Set the Department ID and PIN.**

- To set a PIN, select the [Allow PIN Settings] checkbox, and enter a PIN.
  - Click [Verify] to confirm that the Department ID and PIN have been entered correctly.
- \* This is not available when the machine is connected to the computer via the USB or Web Services on Devices (WSD) port.

**7 Set the authentication process and applicable range, as needed.**

### ■ Confirming the Department ID and PIN when printing

Select the [Confirm Department ID/PIN When Printing] checkboxes.

### ■ When the machine is connected to the computer via the USB or WSD port

Select the [Authenticate Department ID/PIN at Device] checkbox.

## 8 Click [OK] ► [OK].

► The settings are applied.

### ■ When Using macOS

## 1 Click [🍏] ► [System Preferences] ► [Printers & Scanners].

► The [Printers & Scanners] screen is displayed.

## 2 Select the machine, and click [Options & Supplies].

## 3 On the [Options] tab, select the [Department ID Management] checkbox, and click [OK].

## 4 On the driver setting screen, set the Department ID and PIN.

You must set the Department ID and PIN each time you print.

- 1 Display the printing dialog box, and select the printer driver of the machine. ► **Printing from a Computer(P. 154)**
- 2 From the print options pop-up menu, select [Special Features].

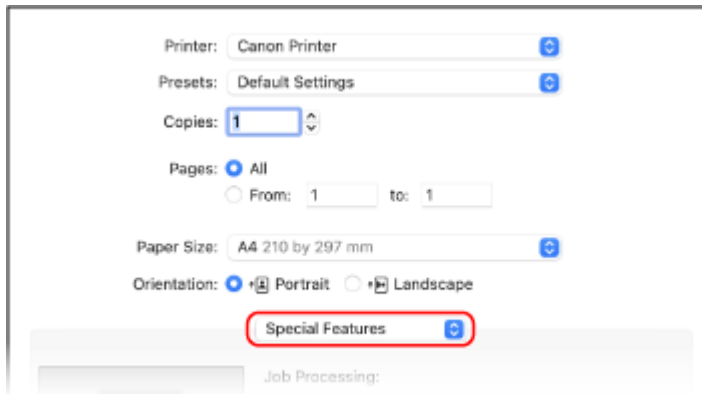

If print options are not displayed, click [Show Details] in the printing dialog box.

- 3 Select the [Use Department ID Management] checkbox, and click [Settings].
  - The [Department ID/PIN Settings] screen is displayed.
- 4 Enter the Department ID and PIN.
- 5 Set the authentication process and applicable range, as needed.

### Confirming the Department ID and PIN when printing

Select the [Confirm Department ID/PIN When Printing] checkbox.

- 6 Click [OK].



## Confirming Usage by Department ID

9664-04X

You can view the number of pages printed for each Department ID when Department ID Management is enabled.

This section describes how to view this information using Remote UI from a computer.

On the control panel, select [Menu] in the [Home] screen, and then select [Management Settings] to view this information. **▶[Department ID Management](P. 345)**

Administrator privileges are required.

**1 Log in to Remote UI in System Manager Mode. ▶Starting Remote UI(P. 256)**

**2 On the Portal page of Remote UI, click [Settings/Registration]. ▶Portal Page of Remote UI(P. 259)**

**3 Click [User Management] ▶ [Department ID Management].**

⇒ The [Department ID Management] screen is displayed.

**4 In [Department ID Page Total], view the usage.**

Department ID	Page Total/Page Restriction
7654321	2
Unknown ID Jobs	0
RX Print	0

### ■ Resetting the count for a specific Department ID only

For the Department ID with the count to reset, click [Clear Count] ▶ [OK].

### ■ Resetting the count for All Department IDs

Click [Clear All Counts] ▶ [OK].

**5 Log out from Remote UI after viewing the usage.**

# Protecting the Network

---

9664-04Y

Connecting the machine to a network allows you link it to computers and mobile devices for more convenient operations. However, this also creates risks of unauthorized access and eavesdropping over the network. By configuring the security settings according to your network environment, you can reduce these risks to ensure safer use of the machine.

## Filtering Using the Firewall Settings

Allows communications only with devices that have a specific IP address or MAC address to prevent unauthorized access.

### ▶ **Setting the Firewall(P. 203)**

## Port Control

If the port number being used by a communicating device, such as a computer or server, is changed, change the setting on the machine too. In addition, if it is clear that there is an unneeded protocol, use of the protocol is prohibited on the machine and that port is closed to prevent intrusion from the outside.

### ▶ **Changing the Port Number(P. 206)**

## Using a Proxy Server

Using a proxy server to connect the machine to a network not only facilitates managing communication with external networks but blocks unauthorized access and consolidates anti-virus protection for enhanced security.

### ▶ **Using a Proxy(P. 207)**

## Encryption of Communication Using TLS

You can use TLS to encrypt communication when using Remote UI. This reduces the risks of data eavesdropping and tampering during communication.

### ▶ **Using TLS(P. 209)**

## Encryption of Communication Using IPSec

Use Internet Protocol Security (IPSec) to encrypt data at the IP protocol level. This reduces the risk of data eavesdropping and tampering during communication without relying on an application or network configuration.

### ▶ **Using IPSec(P. 211)**

## Using the Machine in a Network with IEEE 802.1X Authentication

When connecting the machine to a network that uses IEEE 802.1X authentication, you must configure the settings on the machine such as the authentication method managed by the authentication server.

### ▶ **Using IEEE 802.1X(P. 215)**

## Managing and Verifying the Key and Certificate

You can generate a key and certificate used to encrypt communication and register a key and certificate obtained from a certification authority. By configuring the settings to check the revocation status of a certificate (using OCSP), you can check to see if a certificate received from a certification authority has been revoked.

### ▶ **Managing and Verifying a Key and Certificate(P. 217)**

## ■ See Also

For the network settings at setup, see the following.

### ▶ **Configuring Your Machine for Your Network Environment(P. 62)**

# Setting the Firewall

9664-050

Set up the packet-filtering firewall to prevent unauthorized access.

First, as a prerequisite, set whether to allow or block communication with other devices. Next, specify the IP addresses or MAC addresses of devices you want to block or allow as exceptions.

For the number of addresses that can be specified and the protocols whose communication can be restricted, see the firewall specifications. [▶Firewall\(P. 29\)](#)

[▶Setting IP Address Filtering\(P. 203\)](#)

[▶Setting MAC Address Filtering\(P. 204\)](#)

## IMPORTANT

- MAC address filtering is not available when connecting the machine to a wireless LAN.
- Multicast and broadcast addresses are not restricted even when the setting is configured to block the sending of data from the machine to other devices.

## Setting IP Address Filtering

Set IPv4 address filtering or IPv6 address filtering according to your usage environment.

This section describes how to configure the settings using Remote UI from a computer.

On the control panel, select [Menu] in the [Home] screen, and then select [Preferences] to configure the settings.

However, the control panel can only be used to enable or disable the filter. [▶\[Firewall Settings\]\(P. 291\)](#)

Administrator privileges are required. The machine must be restarted to apply the settings.

## IMPORTANT

- If you set an incorrect IP address, you will no longer be able to access Remote UI. If this happens, use the control panel to disable the firewall settings, and then use Remote UI to set the IP address again.

**1** Log in to Remote UI in System Manager Mode. [▶Starting Remote UI\(P. 256\)](#)

**2** On the Portal page of Remote UI, click [Settings/Registration]. [▶Portal Page of Remote UI\(P. 259\)](#)

**3** Click [Network Settings] ▶ [Firewall Settings].

⇒ The [Firewall Settings] screen is displayed.

**4** Click [Edit] for the IP address send or receive filter.

- To restrict sending of data from the machine to other devices, click [Edit] for the send filter.
- To restrict receiving of data from other devices, click [Edit] for the receive filter.

## 5 Select the [Use Filter] checkbox.

☞ The IP address is enabled.

## 6 In [Default Policy], set the filtering prerequisites.

As a filtering prerequisite, select whether to allow or block communication with other devices.

## 7 Register [Exception Addresses].

- In [Address to Register], enter an IP address, and then click [Add].
- You can also specify a range of IP addresses by using a hyphen (-) or prefix length.

### Input example:

- **One IPv4 address**  
192.168.0.10
- **One IPv6 address**  
fe80::10
- **Specifying a range**  
192.168.0.10-192.168.0.20  
192.168.0.32/27  
fe80::1234/64

## 8 Click [OK].

## 9 Restart the machine. ▶ [Restarting the Machine\(P. 87\)](#)

☞ The settings are applied.

## Setting MAC Address Filtering

This section describes how to configure the settings using Remote UI from a computer. On the control panel, select [Menu] in the [Home] screen, and then select [Preferences] to configure the settings. You cannot use the control panel to configure some of the settings. ▶ [\[Firewall Settings\]\(P. 291\)](#) Administrator privileges are required. The machine must be restarted to apply the settings.

### IMPORTANT

- If you set an incorrect MAC address, you will no longer be able to access Remote UI. If this happens, use the control panel to disable the firewall settings, and then use Remote UI to set the MAC address again.

## 1 Log in to Remote UI in System Manager Mode. ▶ [Starting Remote UI\(P. 256\)](#)

## 2 On the Portal page of Remote UI, click [Settings/Registration]. ▶ [Portal Page of Remote UI\(P. 259\)](#)

### 3 Click [Network Settings] ► [Firewall Settings].

⇒ The [Firewall Settings] screen is displayed.

### 4 Click [Edit] for the MAC address send or receive filter.

- To restrict sending of data from the machine to other devices, click [Edit] for the send filter.
- To restrict receiving of data from other devices, click [Edit] for the receive filter.

### 5 Select the [Use Filter] checkbox.

⇒ The MAC address is enabled.

### 6 In [Default Policy], set the filtering prerequisites.

As a filtering prerequisite, select whether to allow or block communication with other devices.

### 7 Register [Exception Addresses].

- In [Address to Register], enter a MAC address, and then click [Add].
- Enter MAC addresses without separating with hyphens (-) or colons (:).

**Input example:**

123A456B789C

### 8 Click [OK].

### 9 Restart the machine. ► [Restarting the Machine\(P. 87\)](#)

⇒ The settings are applied.

# Changing the Port Number

9664-051

Typically, conventional port numbers are used for major protocols, but these port numbers may be changed to enhance security. As the port numbers must be the same on communicating devices, such as a computer or server, when the port number is changed, the setting on the machine also needs to be changed.

This section describes how to configure the settings using Remote UI from a computer.

On the control panel, select [Menu] in the [Home] screen, and then select [Preferences] to configure the settings. ▶ **[Port Number Settings](P. 300)**

Administrator privileges are required. The machine must be restarted to apply the settings.

## 1 Log in to Remote UI in System Manager Mode. ▶ Starting Remote UI(P. 256)

## 2 On the Portal page of Remote UI, click [Settings/Registration]. ▶ Portal Page of Remote UI(P. 259)

## 3 Click [Network Settings] ▶ [Port Number Settings] ▶ [Edit].

⇒ The [Edit Port Number Settings] screen is displayed.

## 4 Change the port number of the protocol, and click [OK].

## 5 Restart the machine. ▶ Restarting the Machine(P. 87)

⇒ The settings are applied.

## NOTE

### Protocol Settings

- For the protocol settings and settings of the functions using the protocol, see the following:

LPD/RAW/WSD ▶ **Configuring LPD, RAW, or WSD(P. 242)**

HTTP ▶ **Disabling HTTP Communication(P. 244)**

POP3 ▶ **Preparing to Receive and Print I-Faxes(P. 152)**

Multicast Discovery ▶ **Configuring SLP Communication(P. 74)**

SNMP ▶ **Configuring SNMP(P. 69)**

### Changing the Port Number of the Proxy Server

- To change the port number of the proxy server, see the following:
  - ▶ **Using a Proxy(P. 207)**

### Changing the Port Number of the Printer Driver (Windows)

- When the port number of the print protocol (LPD or RAW) is changed on the machine, change the port number setting on the computer too. ▶ **Configuring a Printer Port (Windows)(P. 141)**

## Using a Proxy

Using a proxy server to connect to a network not only facilitates managing communications with external networks but blocks unauthorized access and consolidates anti-virus protection for enhanced security.

Configure these settings using Remote UI from a computer. You cannot use the control panel to configure the settings.

Administrator privileges are required.

### Required Preparations

- Prepare the address, port number, and authentication information of the proxy server.

**1 Log in to Remote UI in System Manager Mode.**  [Starting Remote UI\(P. 256\)](#)

**2 On the Portal page of Remote UI, click [Settings/Registration].**  [Portal Page of Remote UI\(P. 259\)](#)

**3 Click [Network Settings] ▶ [Proxy Settings] ▶ [Edit].**

⇒ The [Edit Proxy Settings] screen is displayed.

**4 Select the [Use Proxy] checkbox.**

**5 Enter the address and port number of the proxy server.**

- In [HTTP Proxy Server Address], enter the IP address and host name.
- In [HTTP Proxy Server Port Number], enter the port number.

**6 Set the applicable range and authentication information according to your usage environment.**

**■When using a proxy server also specified for communication with devices on the same domain**

Select the [Use Proxy within Same Domain] checkbox.

**■When authentication is required to connect to a proxy server**

Select the [Use Proxy Authentication] checkbox, and enter the user name to be used for authentication using single-byte alphanumeric characters.

To set a password to use for authentication, select the [Set/Change Password] checkbox, and enter the password using single-byte alphanumeric characters.

**7 Click [OK].**

⇒ The settings are applied.

## **8 Log out from Remote UI.**



# Using TLS

9664-053

Transport Layer Security (TLS) is a mechanism for encrypting data sent or received over the network. Encrypting communication with TLS when using Remote UI reduces the risks of data eavesdropping and tampering during communication.

To use TLS encrypted communication for Remote UI, specify the key and certificate (server certificate) you want to use, and then enable TLS on Remote UI.

This section describes how to configure the settings using Remote UI from a computer.

On the control panel, select [Menu] in the [Home] screen, and then select [Management Settings] to configure the settings. However, the control panel can only be used to enable or disable TLS on Remote UI. **▶[Use Remote UI] (P. 350)**

Administrator privileges are required. The machine must be restarted to apply the settings.

## Required Preparations

- Prepare the key and certificate to use for TLS encrypted communication. **▶Managing and Verifying a Key and Certificate(P. 217)**

### 1 Log in to Remote UI in System Manager Mode. **▶Starting Remote UI(P. 256)**

### 2 On the Portal page of Remote UI, click [Settings/Registration]. **▶Portal Page of Remote UI(P. 259)**

### 3 In [Network Settings], click [TLS Settings].

⇒ The [TLS Settings] screen is displayed.

### 4 Specify the key and certificate to use for TLS encrypted communication.

#### 1 In [Key and Certificate Settings], click [Key and Certificate].

⇒ The [Key and Certificate Settings] screen is displayed.

#### 2 To the right of the key and certificate to use, click [Register Default Key].

- When you click the key name (or certificate icon), the certificate details appear.
- On the certificate details screen, click [Verify Certificate] to verify that the certificate is valid.

### 5 Set the TLS version and algorithm.

#### 1 Click [TLS Details] ▶ [Edit].

⇒ The [Edit TLS Details] screen is displayed.

#### 2 Set the usable version and algorithm, and click [OK].

Some combinations of versions and algorithms cannot be used. For the supported combinations of versions and algorithms, see the TLS specifications. **▶TLS(P. 32)**

#### [Allowed Versions]

Specify the maximum and minimum versions of TLS.

#### [Algorithm Settings]

Select the checkbox of the algorithm to use for TLS.

## 6 Enable TLS on Remote UI.

- 1 Click [License/Other] ► [Remote UI Settings] ► [Edit].  
    ⇒ The [Edit Remote UI Settings] screen is displayed.
- 2 Select the [Use TLS] checkbox, and click [OK].

## 7 Restart the machine. ► [Restarting the Machine\(P. 87\)](#)

⇒ The settings are applied.

## NOTE

### When a Warning Message Appears at Remote UI Startup

- A warning message about the security certificate may appear when starting up Remote UI with TLS enabled. If there are no problems with the certificate or TLS settings, you can continue operations.

### Using TLS to Encrypt Received I-Faxes

- If the POP3 server support TLS, TLS can be used for communication with the server. ► [Preparing to Receive and Print I-Faxes\(P. 152\)](#)

## Using IPsec

9664-054

Use IP Security Protocol (IPsec) to prevent eavesdropping and tampering of IP packets sent and received over an IP network. This performs encryption at the IP protocol level to ensure security without relying on an application or network configuration.

- ▶ **IPsec Applicable Conditions and Supported Modes(P. 211)**
- ▶ **IPsec Policy Configuration(P. 211)**
- ▶ **Setting IPsec(P. 211)**

### IPsec Applicable Conditions and Supported Modes

#### Packets where IPsec does not apply

- Packets specifying a loopback, multicast, or broadcast address
- IKE packets sent from UDP port 500
- ICMPv6 Neighbor Solicitation and Neighbor Advertisement packets

#### Operation mode of key exchange protocol (IKE mode)

The IKE mode supported by the machine is only the main mode that is used to encrypt packets. The non-encrypting aggressive mode is not supported.

#### Communication mode

The communication mode supported by the machine is only the transport mode, which encrypts only the part excluding the IP header. Tunnel mode, which encrypts the entire IP packet, is not supported.

#### Using IPsec together with IP address filtering

The IP address filter settings are applied first. ▶ **Setting the Firewall(P. 203)**

### IPsec Policy Configuration

To perform IPsec communication on the machine, you must create an IPsec policy that includes the applicable range and algorithms for authentication and encryption. The policy is mainly made up of the following items.

#### Selector

Specify which IP packets to apply IPsec communication. In addition to specifying the IP address of the machine and communicating devices, you can also specify their port numbers.

#### IKE

The key exchange protocol supports Internet Key Exchange Version 1 (IKEv1). For the authentication method, select the pre-shared key method or digital signature method.

- **Pre-shared Key Method:**  
This authentication method uses a common key word, called Shared Key, for communication between the machine and other devices.
- **Digital Signature Method**  
The machine and the other devices authenticate each other by mutually verifying their digital signatures.

#### ESP/AH

Specify the settings for ESP/AH, which is the protocol used for IPsec communication. ESP and AH can be used at the same time. Use Perfect Forward Secrecy (PFS) for even greater security.

### Setting IPsec

Enable the use of IPsec, and then create and register the IPsec policy. If multiple policies have been created, specify the order in which they are applied.

This section describes how to configure the settings using Remote UI from a computer.

On the control panel, select [Menu] in the [Home] screen, and then select [Preferences] to configure the settings. However, the control panel can only be used to enable or disable IPsec. **▶[Use IPsec](P. 300)**  
Administrator privileges are required. The machine must be restarted to apply the settings.

### Required Preparations

- Connect the machine directly to a computer on the same virtual private network (VPN) as the machine. Confirm the operation conditions, and finish the settings on the computer in advance. **▶IPsec(P. 29)**
- Prepare the following according to the IKE authentication method:
  - When using the pre-shared key method, enable TLS for Remote UI communication. **▶Using TLS(P. 209)**
  - When using the digital signature method, prepare the key and certificate to use. **▶Managing and Verifying a Key and Certificate(P. 217)**
- When using PFS, check that PFS is enabled on the communicating device.

## 1 Log in to Remote UI in System Manager Mode. **▶Starting Remote UI(P. 256)**

## 2 On the Portal page of Remote UI, click [Settings/Registration]. **▶Portal Page of Remote UI(P. 259)**

## 3 Click [Network Settings] ▶ [IPsec Settings] ▶ [Edit].

⇒ The [Edit IPsec Settings] screen is displayed.

## 4 Select the [Use IPsec] checkbox, and click [OK].

To only receive packets that meet the policy, clear the [Receive Non-Policy Packets] checkbox.

## 5 Click [Register New Policy].

⇒ The [Register New IPsec Policy] screen is displayed.

## 6 In [Policy Settings], enter the policy name, and select the [Enable Policy] checkbox.

For the policy name, enter a name to identify the policy using single-byte alphanumeric characters.

## 7 In [Selector Settings], set the selector.

### [Local Address Settings]

Select the type of IP address of the machine to which the policy is applied.

- To apply IPsec to all IP packets, select [All IP Addresses].
- To apply IPsec to IP packets sent and received using an IPv4 or IPv6 address, select [IPv4 Address] or [IPv6 Address].

### [Remote Address Settings]

Select the type of IP address of the communicating device to which the policy is applied.

- To apply IPsec to all IP packets, select [All IP Addresses].
- To apply IPsec to IP packets sent and received using an IPv4 or IPv6 address, select [All IPv4 Addresses] or [All IPv6 Addresses].

- To specify an IPv4 or IPv6 address to which IPSec is applied, select [IPv4 Manual Settings] or [IPv6 Manual Settings].

#### [Addresses to Set Manually]

When [IPv4 Manual Settings] or [IPv6 Manual Settings] is selected, enter the IP address. You can also specify a range of IP addresses by using a hyphen (-).

#### Input example:

- **One IPv4 address**  
192.168.0.10
- **One IPv6 address**  
fe80::10
- **Range specification**  
192.168.0.10-192.168.0.20

#### [Subnet Settings]

When [IPv4 Manual Settings] is selected, you can use a subnet mask to specify the range of IPv4 addresses.

#### Input example:

255.255.255.240

#### [Prefix Length]

When [IPv6 Manual Settings] is selected, you can use a prefix length to specify the range of IPv6 addresses. Enter the prefix length with a range of 0 to 128.

#### [Port Settings]

Set the port to which IPSec is applied in [Local Port] on the machine and [Remote Port] on the communicating device.

- To apply IPSec to all port numbers, select [All Ports].
- To apply IPSec to a specific protocol such as HTTP or WSD, select [Single Port], and enter the port number of the protocol.

## 8 In [IKE Settings], set IKE.

#### [IKE Mode]

The machine only supports the main mode.

#### [Authentication Method]

Select the authentication method of the machine.

- When [Pre-Shared Key Method] is selected, click [Shared Key Settings] ► enter the string to use as the shared key using single-byte alphanumeric characters ► click [OK].
- When [Digital Signature Method] is selected, click [Key and Certificate] ► [Register Default Key] to the right of the key and certificate to use.

#### [Validity]

Enter the valid period of IKE SA (ISAKMP SA) to use as the control communication path in minutes.

#### [Authentication/Encryption Algorithm]

Select the algorithm to use for key exchange.

## 9 In [IPSec Network Settings], configure the IPSec network settings.

#### [Use PFS]

Select this checkbox to configure PFS for the session key.

#### [Validity]

Specify the valid period of IPsec SA to use as the data communication path by time, size, or both.

- When the [Specify by Time] checkbox is selected, enter the valid period in minutes.
- When the [Specify by Size] checkbox is selected, enter the valid period in megabytes.
- When both are selected, the item whose specified value is reached first is applied.

#### [Authentication/Encryption Algorithm]

Select this checkbox according to the IPsec header (ESP and AH) to be used and its algorithm.

##### [ESP Authentication]

When [ESP] is selected, select the authentication algorithm. To perform ESP authentication, select [SHA1]. Otherwise, select [Do Not Use].

##### [ESP Encryption]

When [ESP] is selected, select the encryption algorithm. If you do not want to specify the algorithm, select [NULL]. To disable encryption, select [Do Not Use].

#### [Connection Mode]

The machine only supports the transport mode.

## 10 Click [OK].

⇒ The newly registered policy is added to [Registered IPsec Policies] on the [IPsec Settings] screen.

### ■ When multiple policies are registered

Click [Up] or [Down] to the right of the policy name to set the priority. Higher level policies have priority in application to IPsec communication.

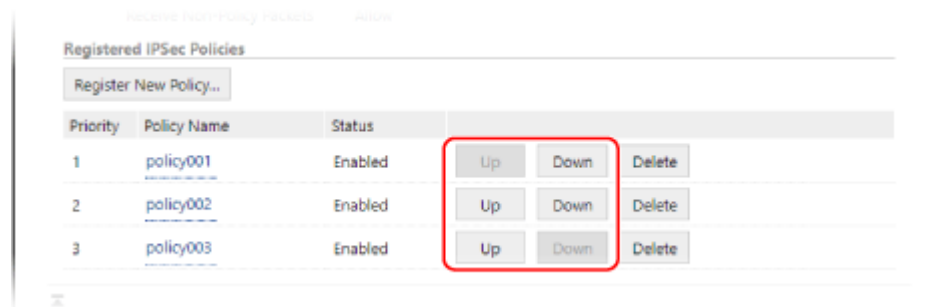

## 11 Restart the machine. ▶ Restarting the Machine(P. 87)

⇒ The settings are applied.

## NOTE

### Editing Registered Policies

- To edit the registered information, click the policy name you want to edit in [Registered IPsec Policies] on the [IPsec Settings] screen.

## Using IEEE 802.1X

In a network environment with IEEE 802.1X authentication, only client devices (supplicants) authenticated by the authentication server (RADIUS server) are allowed to connect to the network via the LAN switch (authenticator), thereby blocking unauthorized access. When connecting the machine to a network that uses IEEE 802.1X authentication, you must configure the settings on the machine such as the authentication method managed by the authentication server.

▶ **IEEE 802.1X Authentication Methods(P. 215)**

▶ **Setting IEEE 802.1X(P. 215)**

### IEEE 802.1X Authentication Methods

The following IEEE 802.1X authentication methods are supported:

#### TLS

The machine and authentication server authenticate each other by mutually verifying their certificates. This cannot be used together with another authentication method.

#### TTLS

This authentication method uses a user name and password for machine authentication and a CA certificate for the server authentication. MSCHAPv2 or PAP can be selected as the internal protocol, and TTLS can be used together with PEAP.

#### PEAP

The required settings are almost the same as those for TTLS, with MSCHAPv2 used as the internal protocol.

### Setting IEEE 802.1X

First enable IEEE 802.1X, and then set the authentication method.

This section describes how to configure the settings using Remote UI from a computer.

On the control panel, select [Menu] in the [Home] screen, and then select [Preferences] to configure the settings.

However, the control panel can only be used to enable or disable IEEE 802.1X. ▶ **[IEEE 802.1X Settings](P. 291)**

Administrator privileges are required. The machine must be restarted to apply the settings.

#### Required Preparations

- When using TLS as the authentication method, prepare the key and certificate issued by the certificate authority and used for authentication of the machine. ▶ **Managing and Verifying a Key and Certificate(P. 217)**
  - \* A preinstalled CA certificate or a CA certificate installed from Remote UI is used for server authentication.
- When using TTLS or PEAP as the authentication method, TLS-encrypt communication using Remote UI. ▶ **Using TLS(P. 209)**

**1** Log in to Remote UI in System Manager Mode. ▶ **Starting Remote UI(P. 256)**

**2** On the Portal page of Remote UI, click [Settings/Registration]. ▶ **Portal Page of Remote UI(P. 259)**

**3** Click [Network Settings] ▶ [IEEE 802.1X Settings] ▶ [Edit].

⇒ The [Edit IEEE 802.1X Settings] screen is displayed.

## 4 Select the [Use IEEE 802.1X] checkbox, and enter the login name.

For the login name, enter a name to identify the user (EAP Identity) using single-byte alphanumeric characters.

### ■ When verifying the certificate of an authentication server

Select the [Verify Authentication Server Certificate] checkbox.

When verifying the common name of the certificate, select the [Verify Authentication Server Name] checkbox, and enter the name of the authentication server to which the user is registered.

## 5 Configure the settings according to the authentication method to be used.

### ■ When using TLS

- 1 Select the [Use TLS] checkbox.
- 2 In [Name of Key to Use], click [Key and Certificate].
  - ⇒ The [Key and Certificate Settings] screen is displayed.
- 3 To the right of the key and certificate to use, click [Register Default Key].
  - Click the key name (or certificate icon) to display the certificate details.
  - On the certificate details screen, click [Verify Certificate] to verify that the certificate is valid.

### ■ When using TTLS or PEAP

- 1 Select the [Use TTLS] or [Use PEAP] checkbox.  
When using TTLS, select the internal protocol to be used.
- 2 Use [Use Login Name as User Name] to specify whether to use the login name of IEEE 802.1X authentication for the user name.
- 3 In [User Name/Password Settings], click [Change User Name/Password].
  - ⇒ The [Change User Name/Password] screen is displayed.
- 4 Set the user name and password, and select the [OK] checkbox.
  - Enter the user name using single-byte alphanumeric characters.
  - To set a password, select the [Change Password] checkbox, and enter the same password in both [Password] and [Confirm] using single-byte alphanumeric characters.

## 6 Click [OK].

## 7 Restart the machine. ▶ Restarting the Machine(P. 87)

⇒ The settings are applied.



# Managing and Verifying a Key and Certificate

---

9664-056

To encrypt communication with TLS when using Remote UI, or to use TLS as the IEEE 802.1X authentication method, a key and certificate are required. In addition, depending on the communicating device, encrypted communication using a specified certificate may be requested, thereby requiring a key and certificate.

## Managing a Key and Certificate

---

You can prepare a key and certificate using the following methods:

### Generating a Key and Certificate on the Machine

Generate the key and certificate required for TLS on the machine. You can immediately communicate where self-signed certificates are allowed.

#### 🔗 **Generating a Key and Certificate(P. 218)**

### Registering a Certificate Issued by a Certificate Authority in a Self-generated Key

When a key is generated on the machine, generate a Certificate Signing Request (CSR), have the certificate authority issue a certificate, and then register that certificate in the key.

#### 🔗 **Generating a Key and Certificate Signing Request (CSR) and Obtaining and Registering a Certificate(P. 220)**

### Registering a Certificate Obtained from an SCEP Server to a Self-generated Key

When generating a key on the machine, request a Simple Certificate Enrollment Protocol (SCEP) server to issue a certificate, and then register the obtained certificate. You can also request that a certificate be issued at a specified date and time.

#### 🔗 **Generating a Key and Obtaining and Registering a Certificate from an SCEP Server(P. 223)**

### Registering a Key and Certificate or CA Certificate Obtained from an Issuing Authority

Register a key and certificate obtained from an issuing authority or a CA certificate issued by a certificate authority, without self-generating the key and certificate. You can use a digital certificate that matches the communicating device and authentication level.

#### 🔗 **Registering a Key and Certificate or CA Certificate Obtained from an Issuing Authority(P. 230)**

## Verifying a Certificate

---

You can configure the settings to verify the validity of a certificate that the machine receives from a certificate authority, using the Online Certificate Status Protocol (OCSP).

#### 🔗 **Verifying a Received Certificate with OCSP(P. 232)**

# Generating a Key and Certificate

Generate the key and certificate required for TLS-encrypted communication on the machine. A self-signed certificate is used for the self-generated key.

For the algorithm of the keys and certificates that can be generated with this machine, see the specifications of the self-generated key and self-signed certificate. [▶Keys and Certificates\(P. 30\)](#)

Generate a key and certificate using Remote UI from a computer. You cannot use the control panel to generate a key and certificate.

Administrator privileges are required.

## 1 Log in to Remote UI in System Manager Mode. [▶Starting Remote UI\(P. 256\)](#)

## 2 On the Portal page of Remote UI, click [Settings/Registration]. [▶Portal Page of Remote UI\(P. 259\)](#)

## 3 Click [Device Management] ▶ [Key and Certificate Settings] ▶ [Generate Key].

⇒ The [Generate Key] screen is displayed.

## 4 Select [Network Communication], and click [OK].

⇒ The [Generate Network Communication Key] screen is displayed.

## 5 In [Key Settings], enter the name of the key, and select the signature and key algorithm.

- Enter the key name using single-byte alphanumeric characters.
- For the key algorithm, select [RSA] or [ECDSA], and select the key length from the pulldown menu. The longer the key length, the better the security, but this slows down communication processing.

## 6 In [Certificate Settings], set the certificate information.

**[Validity Start Date (YYYY/MM/DD)]/[Validity End Date (YYYY/MM/DD)]**

Enter the start and end dates of the certificate validity period.

**[Country/Region]**

Select [Select Country/Region], and then select the country or region from the pulldown menu, or select [Enter Internet Country Code], and enter the country code.

**[State]/[City]/[Organization]/[Organization Unit]**

Enter the items as needed using single-byte alphanumeric characters.

**[Common Name]**

Enter the name of the certificate subject as needed using single-byte alphanumeric characters. This corresponds to the Common Name (CN).

## 7 Click [OK].

- ➡ The generated key and certificate are added to [Registered Key and Certificate] on the [Key and Certificate Settings] screen.

## **8 Log out from Remote UI.**

### **NOTE**

#### **Viewing and Verifying Detailed Information of a Generated Certificate**

- When you click the key name (or certificate icon) in [Registered Key and Certificate] on the [Key and Certificate Settings] screen, the certificate details appear.
- On the certificate details screen, click [Verify Certificate] to verify that the certificate is valid.

#### **When the Key and Certificate Cannot Be Deleted**

- You cannot delete a key and certificate being used. Disable the function being used, or delete these after switching to another key and certificate.

# Generating a Key and Certificate Signing Request (CSR) and Obtaining and Registering a Certificate

9664-058

As a certificate generated on the machine does not have a signature from a certificate authority, the machine may not be able to communicate depending on the communicating device. In this case, registering a signed certificate issued by a certificate authority to the key enables communication even with a self-generated key.

For the certificate authority to issue a signed certificate, you must make a request attached with a Certificate Signing Request (CSR). The machine generates a CSR at the same time it generates a key.

For more information about the keys that can be generated by the machine and the CSR algorithm, see self-generated key and CSR specifications. [▶Keys and Certificates\(P. 30\)](#)

[▶Generating a Key and CSR\(P. 220\)](#)

[▶Registering a Certificate Issued by a Certificate Authority to a Key\(P. 221\)](#)

## Generating a Key and CSR

Generate a key and CSR using Remote UI from a computer. You cannot use the control panel to generate a key and certificate.

Administrator privileges are required.

**1 Log in to Remote UI in System Manager Mode.** [▶Starting Remote UI\(P. 256\)](#)

**2 On the Portal page of Remote UI, click [Settings/Registration].** [▶Portal Page of Remote UI\(P. 259\)](#)

**3 Click [Device Management] ▶ [Key and Certificate Settings] ▶ [Generate Key].**

⇒ The [Generate Key] screen is displayed.

**4 Select [Key and Certificate Signing Request (CSR)], and click [OK].**

⇒ The [Generate Key and Certificate Signing Request (CSR)] screen is displayed.

**5 In [Key Settings], enter the name of the key, and select the signature algorithm and key algorithm.**

- Enter the key name using single-byte alphanumeric characters.
- For the key algorithm, select [RSA] or [ECDSA], and select the key length from the pulldown menu. The longer the key length, the better the security, but this slows down communication processing.

**6 In [Certificate Signing Request (CSR) Settings], set the CSR information.**

**[Country/Region]**

Select [Select Country/Region], and either select the country or region from the pulldown menu, or select [Enter Internet Country Code] and enter the country code.

**[State]/[City]/[Organization]/[Organization Unit]**

Enter the items as needed using single-byte alphanumeric characters.

**[Common Name]**

Enter the name of the certificate subject as needed using single-byte alphanumeric characters. This corresponds to the Common Name (CN).

**7 Click [OK].**

⇒ The [Key and Certificate Signing Request (CSR) Details] screen is displayed.

**8 Click [Store in File] to save the CSR file to a computer.**

**9 Log out from Remote UI.**

**10 Submit the application with CSR file attached to the certificate authority.**

## NOTE

- When the CSR is generated, the key is registered to the machine, but it cannot be used until the certificate issued by the certificate authority is registered.

## Registering a Certificate Issued by a Certificate Authority to a Key

Register the certificate using Remote UI from a computer. You cannot use the control panel to register it. Administrator privileges are required.

**1 Log in to Remote UI in System Manager Mode. ▶ Starting Remote UI(P. 256)**

**2 On the Portal page of Remote UI, click [Settings/Registration]. ▶ Portal Page of Remote UI(P. 259)**

**3 Click [Device Management] ▶ [Key and Certificate Settings].**

⇒ The [Key and Certificate Settings] screen is displayed.

**4 Click the key name (or certificate icon) to which to register the certificate.**

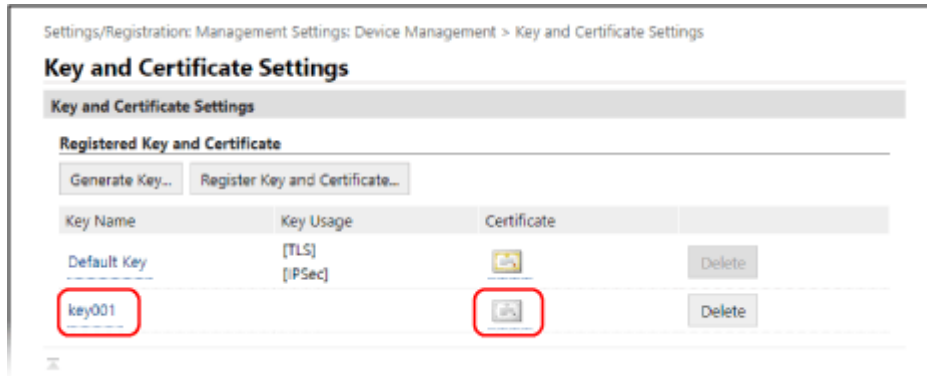



⇒ The [Key and Certificate Signing Request (CSR) Details] screen is displayed.

## 5 Click [Register Certificate].

## 6 In [Specify File], click [Browse], and specify the file of the certificate issued by the certificate authority.

## 7 Click [Register].

⇒ The icon of the certificate displayed in [Registered Key and Certificate] on the [Key and Certificate Settings] screen changes from [  ] to [  ].

## 8 Log out from Remote UI.

## NOTE

### Viewing and Verifying Detailed Information of a Registered Certificate

- Click the key name (or certificate icon) in [Registered Key and Certificate] on the [Key and Certificate Settings] screen to display the certificate details.
- On the certificate details screen, click [Verify Certificate] to verify that the certificate is valid.

### When the Key and Certificate Cannot Be Deleted

- You cannot delete a key and certificate being used. Disable the function being used, or delete these after switching to another key and certificate.

# Generating a Key and Obtaining and Registering a Certificate from an SCEP Server

9664-059

When generating a key on the machine, you can request a Simple Certificate Enrollment Protocol (SCEP) server that manages certificates to issue a certificate. The certificate issued by an SCEP server is registered automatically to the machine.

For information about the algorithm of the keys that can be generated with this machine and certificates that can be requested to be issued, see the specifications of the self-generated key and Certificate Signing Request (CSR). **▶Keys and Certificates(P. 30)**

This machine supports Network Device Enrollment Service (NDES) in Windows Server 2008 R2, 2012 R2, and 2016 for the SCEP server. Communication using HTTPS is not supported.

To obtain and register a certificate from an SCEP server, configure the settings for communicating with the SCEP server, and then generate a key and request certificate issuance. You can also request certificate issuance at a specified date and time.

- ▶**Configuring the SCEP Server Communication Settings(P. 223)**
- ▶**Generating a Key and Requesting Certificate Issuance(P. 224)**
- ▶**Requesting Certificate Issuance at a Specified Date and Time(P. 225)**

## Configuring the SCEP Server Communication Settings

Configure the communication settings using Remote UI from a computer. You cannot use the control panel to configure the settings. Administrator privileges are required.

### Required Preparations

- Prepare the URL and port number of the SCEP server.
  - \* Communication using HTTPS is not supported.

- 1 Log in to Remote UI in System Manager Mode. ▶Starting Remote UI(P. 256)**
- 2 On the Portal page of Remote UI, click [Settings/Registration]. ▶Portal Page of Remote UI(P. 259)**
- 3 Click [Device Management] ▶ [Settings for Certificate Issuance Request (SCEP)].**
  - ⇒ The [Settings for Certificate Issuance Request (SCEP)] screen is displayed.
- 4 In [Communication Settings], click [Edit].**
  - ⇒ The [Edit Communication Settings] screen is displayed.
- 5 Set the SCEP server information.**

[SCEP Server URL]

Enter the URL of the connecting SCEP server.

**[Port Number]**

Enter the port number used to communicate with the SCEP server.

**[Communication Timeout]**

Enter the time from search start to timeout in seconds.

## 6 Click [OK].

⇒ The settings are applied.

## 7 Log out from Remote UI.

## Generating a Key and Requesting Certificate Issuance

Configure the settings for generating a key and requesting the issuance of a certificate using Remote UI from a computer. You cannot use the control panel to configure the settings.

Administrator privileges are required. The machine must be restarted after obtaining a key.

\* This method cannot be used to request issuance of a certificate when the setting for requesting issuance of a certificate at a specified date and time is enabled. ▶ **Requesting Certificate Issuance at a Specified Date and Time(P. 225)**

### 1 Log in to Remote UI in System Manager Mode. ▶ **Starting Remote UI(P. 256)**

### 2 On the Portal page of Remote UI, click [Settings/Registration]. ▶ **Portal Page of Remote UI(P. 259)**

### 3 Click [Device Management] ▶ [Settings for Certificate Issuance Request (SCEP)] ▶ [Certificate Issuance Request].

⇒ The [Certificate Issuance Request] screen is displayed.

### 4 Set the items for a key and certificate.

**[Key Name]**

Enter the key name using single-byte alphanumeric characters.

**[Signature Algorithm]**

Select the signature algorithm from the pulldown menu.

**[Key Length (bit)]**

Select the key length from the pulldown menu. The larger the value, the better the security, but this slows down communication processing.

**[Organization]**

Enter the organization name using single-byte alphanumeric characters, as needed.

**[Common Name]**

Enter the name of the certificate subject using single-byte alphanumeric characters. This is also called the Common Name (CN).

**[Challenge Password]**



When the SCEP server has a password, enter the password for the request data used for the issuance request using single-byte alphanumeric characters.

**[Key Usage]**

Select the usage of the generated key. If the usage is not decided, select [None].

**5 Click [Issuance Request] ▶ [OK].**

⇒ The request to issue a certificate is sent to the SCEP server.

**6 When the message that says a certificate is acquired appears, click [Restart].**

⇒ The machine restarts, and the key and certificate are registered.

## NOTE

### Viewing Issuance Request Status and Error Information

- You can view detailed information on the [Settings for Certificate Issuance Request (SCEP)] screen. If a certificate is not issued, an error is displayed in the certificate issuance request status. For details about the message and how to resolve it, see the following:
  - ▶ **If an Error Is Displayed in the Certificate Issuance Request Status(P. 228)**

### Viewing and Verifying Detailed Information of a Registered Certificate

- In [Settings/Registration] ▶ [Device Management] ▶ [Key and Certificate Settings] ▶ [Registered Key and Certificate], click the key name (or certificate icon) to display the certificate details.
- On the certificate details screen, click [Verify Certificate] to verify that the certificate is valid.

### When the Key and Certificate Cannot Be Deleted

- You cannot delete a key and certificate being used. Disable the function being used, or delete these after switching to another key and certificate.

## Requesting Certificate Issuance at a Specified Date and Time

The request for certificate issuance occurs at the specified date and time. You can also set the request for certificate issuance to occur regularly.

Configure the settings using Remote UI from a computer. You cannot use the control panel to configure the settings. Administrator privileges are required.

**1 Log in to Remote UI in System Manager Mode. ▶ Starting Remote UI(P. 256)**

**2 On the Portal page of Remote UI, click [Settings/Registration]. ▶ Portal Page of Remote UI(P. 259)**

**3 Click [Device Management] ▶ [Settings for Certificate Issuance Request (SCEP)].**

⇒ The [Settings for Certificate Issuance Request (SCEP)] screen is displayed.

**4 In [Settings for Certificate Issuance Auto Request], click [Edit].**

➡ The [Edit Settings for Certificate Issuance Auto Request] screen is displayed.

**5 Select the [Enable Timer for Certificate Issuance Auto Request] checkbox, and enter the start date and time to request issuance of a certificate.**

**6 Set other items at the time of issuance auto request, as needed.**

**[Auto Adjust Issuance Request Time]**

To adjust the certificate issuance request time, select this checkbox.

The start time for issuing a certificate may be adjusted randomly by up to 10 minutes to reduce the load on the SCEP server.

**[Perform Polling When Communication Error Occurs or When Issuance Request Is Deferred]**

Check the status of the SCEP server, such as when certificate issuance has been deferred. Select the checkbox and enter the number of polling retries and interval.

\* Polling is not performed and an error occurs in the following cases:

- When the machine has exceeded the limit of keys and certificates that can be registered
- When an error occurs in the obtained response data
- When an error occurs in the SCEP server

**[Send Periodic Issuance Requests]**

The request for certificate issuance occurs automatically and regularly. Select the checkbox and select the issuance request interval from the pulldown menu.

Enabling this setting resets the start date and time to request issuance of a certificate.

**[Automatically Restart Device After Acquiring Certificate]**

To restart the machine after obtaining a certificate, select the checkbox.

**[Delete Old Key and Certificate]**

To overwrite the key and certificate with the same location where the key will be used, select the checkbox.

**7 In [Settings for Key and Certificate To Be Issued], set the items for a key and certificate.**

**[Key Name]**

Enter the key name using single-byte alphanumeric characters.

**[Signature Algorithm]**

Select the signature algorithm from the pulldown menu.

**[Key Length (bit)]**

Select the key length from the pulldown menu. The larger the value, the better the security, but this slows down communication processing.

**[Organization]**

Enter the organization name using single-byte alphanumeric characters, as needed.

**[Common Name]**

Enter the name of the certificate subject using single-byte alphanumeric characters. This is also called the Common Name (CN).

**[Challenge Password]**

When the SCEP server has a password, enter the password for the request data used for the issuance request using single-byte alphanumeric characters.

**[Key Usage]**

Select the the usage of the generated key. If the usage is not decided, select [None].

## 8 Click [OK].

⇒ The settings are applied.

## 9 Log out from Remote UI.

### NOTE

#### Viewing Issuance Request Status and Error Information

- You can view detailed information on the [Settings for Certificate Issuance Request (SCEP)] screen. If a certificate is not issued, an error is displayed in the certificate issuance request status. For details about the message and how to resolve it, see the following:
  - ▶ **If an Error Is Displayed in the Certificate Issuance Request Status(P. 228)**

#### Viewing and Verifying Detailed Information of a Registered Certificate

- In [Settings/Registration] ▶ [Device Management] ▶ [Key and Certificate Settings] ▶ [Registered Key and Certificate], click the key name (or certificate icon) to display the certificate details.
- On the certificate details screen, click [Verify Certificate] to verify that the certificate is valid.

#### When the Key and Certificate Cannot Be Deleted

- You cannot delete a key and certificate being used. Disable the function being used, or delete these after switching to another key and certificate.

# If an Error Is Displayed in the Certificate Issuance Request Status

9664-05A

If a certificate is not issued, an error is displayed in the certificate issuance request status. Select the message from the list below, and check how to troubleshoot the problem.

- ▶ **Key and Certificate Registration Limit Error(P. 228)**
- ▶ **Communication Error (SCEP ERROR - Fail Info 0: Unrecognized or Unsupported Algorithm)(P. 228)**
- ▶ **Communication Error (SCEP ERROR - Fail Info 1: CMS Message Integrity Verification Failure)(P. 228)**
- ▶ **Communication Error (SCEP ERROR - Fail Info 2: Forbidden or Unsupported Transaction)(P. 229)**
- ▶ **Communication Error (SCEP ERROR - Fail Info 3: Excessive Time Difference Between CMS signingTime and System Time)(P. 229)**
- ▶ **Communication Error (SCEP ERROR - Fail Info 4: No Certificate Identified That Matches Provided Criteria) (P. 229)**
- ▶ **Communication Error (TCP ERROR)(P. 229)**
- ▶ **Communication Error (HTTP ERROR <HTTP status code>)(P. 229)**
- ▶ **Deferred(P. 229)**

## NOTE

- If the problem persists even after trying the troubleshooting methods, contact the SCEP server administrator.

### Key and Certificate Registration Limit Error

The maximum number of keys and certificates that can be registered to the machine has been reached. Delete unused keys and certificates.

### Communication Error (SCEP ERROR - Fail Info 0: Unrecognized or Unsupported Algorithm)

The algorithm of the certificate is unknown or is not supported.

**Set the [Signature Algorithm] and [Key Length (bit)] of the Certificate Issuance Request Correctly.**

- ▶ **Generating a Key and Obtaining and Registering a Certificate from an SCEP Server(P. 223)**

### Communication Error (SCEP ERROR - Fail Info 1: CMS Message Integrity Verification Failure)

Certificate integrity check (CMS message signature verification) failed.

**Request Certificate Issuance Again.**

- ▶ **Generating a Key and Obtaining and Registering a Certificate from an SCEP Server(P. 223)**

## Communication Error (SCEP ERROR - Fail Info 2: Forbidden or Unsupported Transaction)

Communication with the SCEP server is not allowed or supported.

**Set the Communication Settings of the SCEP Server Correctly.**

- ▶ **Generating a Key and Obtaining and Registering a Certificate from an SCEP Server(P. 223)**

## Communication Error (SCEP ERROR - Fail Info 3: Excessive Time Difference Between CMS signingTime and System Time)

The time of the signingTime attribute in the authenticated attribute of CMS (PKCS#7) does not match the time of the SCEP server.

**Check the Date and Time Settings on the Machine.**

If the settings are not correct, set the time zone, and then set the current date and time. Request certificate issuance again.

- ▶ **Setting the Date and Time(P. 254)**
- ▶ **Generating a Key and Obtaining and Registering a Certificate from an SCEP Server(P. 223)**

## Communication Error (SCEP ERROR - Fail Info 4: No Certificate Identified That Matches Provided Criteria)

Unable to identify if the certificate matches the standard.

**Contact the SCEP Server Administrator.**

## Communication Error (TCP ERROR)

Connection to SCEP server failed or timed out.

**Set the Communication Settings of the SCEP Server Correctly.**

- ▶ **Generating a Key and Obtaining and Registering a Certificate from an SCEP Server(P. 223)**

## Communication Error (HTTP ERROR <HTTP status code>)

HTTP error occurred.

**Set the Communication Settings of the SCEP Server Correctly.**

- ▶ **Generating a Key and Obtaining and Registering a Certificate from an SCEP Server(P. 223)**

## Deferred

SCEP server returned a deferred status.

**Wait a Moment, and Request Certificate Issuance.**

- ▶ **Generating a Key and Obtaining and Registering a Certificate from an SCEP Server(P. 223)**

# Registering a Key and Certificate or CA Certificate Obtained from an Issuing Authority

9664-05C

Install and register a key and certificate or CA certificate obtained from a digital certificate issuing authority to the machine before starting to use them.

Register the key and certificate or CA certificate using Remote UI from a computer. You cannot use the control panel to register these. Administrator privileges are required.

## Required Preparations

- Check the conditions of the key and certificate or CA certificate usable with the machine. [▶Keys and Certificates\(P. 30\)](#)
- When registering a key and certificate, check the password for the private key set in the file.

### 1 Log in to Remote UI in System Manager Mode. [▶Starting Remote UI\(P. 256\)](#)

### 2 On the Portal page of Remote UI, click [Settings/Registration]. [▶Portal Page of Remote UI\(P. 259\)](#)

### 3 Click [Device Management] ▶ [Key and Certificate Settings] or [CA Certificate Settings].

⇒ The [Key and Certificate Settings] screen or [CA Certificate Settings] screen is displayed.

### 4 Click [Register Key and Certificate] or [Register CA Certificate].

⇒ The [Register Key and Certificate] screen or [Register CA Certificate] screen is displayed.

### 5 Install the key and certificate file or CA certificate file.

1 Click [Install].

2 Click [Browse] in [Specify File], and specify the file to be installed.

3 Click [Start Installation].

⇒ The installed file is added to [Installed Key and Certificate] on the [Register Key and Certificate] screen or [Installed CA Certificate] on the [Register CA Certificate] screen.

### 6 Registering the key and certificate or CA certificate.

#### ■ When registering a key and certificate

1 To the right of the key and certificate file to register, click [Register].

⇒ The [Enter Private Key Password] screen is displayed.

**2** Enter the key name password using single-byte alphanumeric characters, and click [OK].

⇒ The registered key and certificate are added to [Registered Key and Certificate] on the [Key and Certificate Settings] screen.

### ■ When registering a CA certificate

To the right of the CA certificate file to register, click [Register].

⇒ The registered CA certificate is added to [Registered CA Certificate] on the [CA Certificate Settings] screen.

## 7 Log out from Remote UI.

### NOTE

#### Viewing and Verifying Detailed Information of a Registered Certificate

- When you click the key name (or certificate icon) in [Registered Key and Certificate] on the [Key and Certificate Settings] screen, the certificate details appear.
- On the certificate details screen, click [Verify Certificate] to verify that the certificate is valid.

#### Viewing and Verifying Detailed Information of a Registered CA Certificate

- When you click the issued to location in [Registered CA Certificate] on the [CA Certificate Settings] screen, the CA certificate details appear.
- On the CA certificate details screen, click [Verify Certificate] to verify that the CA certificate is valid.

#### When the Key and Certificate or CA Certificate Cannot Be Deleted

- You cannot delete a key and certificate being used. Disable the function being used, or delete these after switching to another key and certificate.
- A preinstalled CA certificate cannot be deleted. If a preinstalled CA certificate is not required, click [Disable] to the right of the CA certificate.

# Verifying a Received Certificate with OCSP

9664-05E

Online Certificate Status Protocol (OCSP) is a protocol for inquiring to an OCSP responder (server that supports OCSP) about the revocation status of a certificate received from a certificate authority. You can configure the settings to verify the validity of a certificate that the machine receives from a certificate authority, using the OCSP.

Configure these settings using Remote UI from a computer. You cannot use the control panel to configure the settings. Administrator privileges are required.

- 1 Log in to Remote UI in System Manager Mode. ▶ Starting Remote UI(P. 256)**
- 2 On the Portal page of Remote UI, click [Settings/Registration]. ▶ Portal Page of Remote UI(P. 259)**
- 3 Click [Device Management] ▶ [OCSP (Online Certificate Status Protocol) Settings] ▶ [Edit].**

⇒ The [Edit OCSP (Online Certificate Status Protocol) Settings] screen is displayed.

- 4 Select the [Use OCSP (Online Certificate Status Protocol)] checkbox.**
- 5 Set the certificate verification level and the OCSP responder.**

#### [Certificate Verification Level]

Set whether to validate the certificate even if its revocation status cannot be confirmed, such as when the machine is unable to connect to an OCSP responder.

#### [OCSP Responder Settings]

Specify the URL of the OCSP responder.

#### [Custom URL]

When [Use Custom URL] or [Use Certificate URL (Use Custom URL If Certificate URL Cannot Be Retrieved)] is selected, enter the URL of the OCSP responder.

#### [Communication Timeout]

Enter the time from search start to timeout in seconds.

- 6 Click [OK].**

⇒ The settings are applied.

- 7 Log out from Remote UI.**



## Preventing Leaking Information

---

9664-05F

Leaving a printed document on the machine poses a risk of information leakage. In addition, while using memory media and mobile devices is easy and convenient, these can lead to information theft.

You can take measures to prevent leaking information, according to the usage status of the function, to ensure safer use of the machine.

### **Appropriately Restricting Functions**

You can restrict access to part or all of a function using memory media and mobile devices.

- ▶ **Restricting Use of Memory Media(P. 234)**
- ▶ **Restricting Use from a Mobile Device(P. 235)**

### **Preventing Unattended Printed Documents and Information Theft**

You can store print data sent from a computer without printing them immediately.

- ▶ **Restricting Printing(P. 236)**

# Restricting Use of Memory Media

9664-0CC

USB memory devices and other memory media can be easy and convenient, but they can also lead to information leakage. You can prohibit the use of memory media.

This section describes how to configure the settings using Remote UI from a computer.

On the control panel, select [Menu] in the [Home] screen, and then select [Preferences] to configure the settings. [▶ \[USB Settings\]\(P. 302\)](#)

Administrator privileges are required. The machine must be restarted to apply the settings.

## NOTE

- Even if you use this setting to restrict the use of memory media, a computer can still be connected to the USB port on the back of the machine. To also restrict computer connections, see the following.  
[▶ Preventing Connection to Computer via USB Port\(P. 241\)](#)

**1** Log in to Remote UI in System Manager Mode. [▶ Starting Remote UI\(P. 256\)](#)

**2** On the Portal page of Remote UI, click [Settings/Registration]. [▶ Portal Page of Remote UI\(P. 259\)](#)

**3** Click [External Interface Settings] ▶ [Edit].

⇒ The [Edit External Interface Settings] screen is displayed.

**4** Clear the [Use USB Storage Device] checkbox, and click [OK].

**5** Restart the machine. [▶ Restarting the Machine\(P. 87\)](#)

⇒ The settings are applied.

# Restricting Use from a Mobile Device

9664-05J

The machine supports the Mopria® plugin, which is supported by various manufacturers.

Mopria® enables printing from any application, such as on a smartphone, or a device equipped with Chrome OS without having to install a dedicated Canon plugin.

Printing from a mobile device can be easy and convenient, but it can also lead to information leakage. You can also prohibit use of Mopria®.

Configure this setting using Remote UI from a computer. You cannot use the control panel to configure the setting. Administrator privileges are required.

## 1 Log in to Remote UI in System Manager Mode. ▶ Starting Remote UI(P. 256)

## 2 On the Portal page of Remote UI, click [Settings/Registration]. ▶ Portal Page of Remote UI(P. 259)

## 3 Click [Network Settings] ▶ [Mopria Settings] ▶ [Edit].

⇒ The [Edit Mopria Settings] screen is displayed.

## 4 Clear the [Use Mopria] checkbox, and click [OK].

⇒ The settings are applied.

## 5 Log out from Remote UI.

### NOTE

- When the Mopria® setting is enabled, the HTTP, IPP printing, and mDNS (IPv4/IPv6) network settings are also enabled.
  - ▶[TCP/IP Settings](P. 295)

## Restricting Printing

---

9664-05K

You can require users to enter a PIN before printing. This can prevent not only unattended printed documents and information theft, but also unneeded printing, thereby saving paper.

➤ **Restricting Printing from a Computer to Secure Print(P. 237)**

### ■ See Also

By using the Department ID Management function, you can restrict the number of pages that can be printed and the print function for each Department ID. You can also restrict printing from an unknown Department ID.

➤ **Authenticating Users and Managing Groups with Department ID (Department ID Management)(P. 194)**

# Restricting Printing from a Computer to Secure Print

9664-05L

With Secure Print, you can set a PIN to a document on the computer and send that document to the machine to be printed. Printing is performed after that PIN is entered on the machine. Restricting printing from a computer to Secure Print can prevent unattended printed documents and information theft. You can also confirm the print data before printing to prevent unwanted printing.

This section describes how to configure the settings using Remote UI from a computer.

On the control panel, select [Menu] in the [Home] screen, and then select [Function Settings] to configure the settings.

▶[Secure Print](P. 316)

Administrator privileges are required.

**1 Log in to Remote UI in System Manager Mode. ▶Starting Remote UI(P. 256)**

**2 On the Portal page of Remote UI, click [Settings/Registration]. ▶Portal Page of Remote UI(P. 259)**

**3 Click [Secure Print Settings] ▶ [Edit].**

⇒ The [Edit Secure Print Settings] screen is displayed.

**4 Check that the [Secure Print] checkbox is selected.**

**5 Select the [Restrict Printer Jobs] checkbox.**

**6 Click [OK].**

⇒ The settings are applied.

**7 Log out from Remote UI.**

## NOTE

- For details about printing with Secure Print and the time period that Secure Print data is saved, see the following:

▶Printing a Document Secured with a PIN (Secure Print)(P. 159)

▶Changing the Time Period That Print Data with a PIN (Secure Data) Is Saved(P. 162)

# Preventing Unauthorized Use

---

9664-05R

The machine provides various settings to ensure efficient management and operation. While this information and the settings provide convenience, they can also lead to information leakage and other security issues if the information and settings can be accessed by anyone.

You can take measures to restrict access and disable functions according to the usage status of the function, to ensure safer use of the machine.

## **Restricting Access to Information and Settings**

Restricting users and operations accessing information and settings on the machine can help prevent unauthorized use and protect confidential information.

▶ **Restricting Use of Remote UI(P. 239)**

## **Disabling Unused Functions**

You can disable unused functions to prevent intrusion from the outside.

▶ **Preventing Connection to Computer via USB Port(P. 241)**

▶ **Configuring LPD, RAW, or WSD(P. 242)**

▶ **Disabling HTTP Communication(P. 244)**

▶ **Restricting Use of the Control Panel(P. 245)**

## ■ See Also

For details about the administrator account and how to manage users and groups with access to the machine, see the following.

▶ **Setting the Department ID and PIN for the Administrator(P. 191)**

▶ **Authenticating Users and Managing Groups with Department ID (Department ID Management)(P. 194)**

## Restricting Use of Remote UI

While Remote UI is convenient for operating the machine from a computer, it also poses a risk of third-party access to the machine.

You can configure the setting to require users to enter a PIN (Remote UI Access PIN) when using Remote UI to prevent unauthorized access by a third party.

If you do not use Remote UI, it is recommended that you disable the function.

▶ [Setting the PIN to Use for Remote UI\(P. 239\)](#)

▶ [Disabling Remote UI\(P. 239\)](#)

### Setting the PIN to Use for Remote UI

You can restrict the use of Remote UI to only those users who know the Remote UI Access PIN.

This setting is not required when using Department ID Management, as Department ID authentication is performed.

This section describes how to configure the settings using the control panel.

You can also configure the settings using Remote UI from a computer after the Remote UI Access PIN has been set on the machine. ▶ [Managing the Machine from a Computer \(Remote UI\)\(P. 255\)](#)

Administrator privileges are required.

**1** On the control panel, select [Menu] in the [Home] screen, and press **OK**. ▶ **[Home] Screen(P. 94)**

**2** Press [Management Settings] ▶ **OK** ▶ [Remote UI Settings/Update Firmware] ▶ **OK** ▶ [Remote UI Settings] ▶ **OK** ▶ [Remote UI Access Security Settings] ▶ **OK**.

⇒ The [RUI Access Security] screen is displayed.

If the login screen appears, enter the System Manager ID and PIN, and then press **ID**. ▶ [System Manager ID and PIN\(P. 6\)](#)

**3** Set [Remote UI Access Security Settings] to [On], enter the Remote UI Access PIN, and press **OK**.

**4** Enter the same number, and press **OK**.

⇒ The settings are applied.

## NOTE

### When [Management Settings] of the Settings Menu Is Initialized

- Use the settings menu on the control panel to reset the Remote UI Access PIN. ▶ [\[Remote UI Access Security Settings\]\(P. 350\)](#)

### Disabling Remote UI

You can disable Remote UI to reduce the risk of unauthorized access to the machine via the network.

Use the control panel to configure the settings. You cannot configure the settings using Remote UI from a computer. Administrator privileges are required. The machine must be restarted to apply the settings.

**1** On the control panel, select [Menu] in the [Home] screen, and press **OK**. ▶ [Home] Screen(P. 94)

**2** Press [Management Settings] ▶ **OK** ▶ [Remote UI Settings/Update Firmware] ▶ **OK** ▶ [Remote UI Settings] ▶ **OK**.

⇒ The [Remote UI Settings] screen is displayed.

If the login screen appears, enter the System Manager ID and PIN, and then press **ID**. ▶ System Manager ID and PIN(P. 6)

**3** Press [Use Remote UI] ▶ **OK** ▶ [Off] ▶ **OK**.

**4** Restart the machine. ▶ Restarting the Machine(P. 87)

⇒ The settings are applied.



# Preventing Connection to Computer via USB Port

9664-OCE

You can disable the USB port for computer connection on the back of the machine to reduce the risk of an external connection without going through a network with security measures.

This section describes how to configure the settings using Remote UI from a computer.

On the control panel, select [Menu] in the [Home] screen, and then select [Preferences] to configure the settings. ▶ **[USB Settings](P. 302)**

Administrator privileges are required. The machine must be restarted to apply the settings.

**1 Log in to Remote UI in System Manager Mode. ▶Starting Remote UI(P. 256)**

**2 On the Portal page of Remote UI, click [Settings/Registration]. ▶Portal Page of Remote UI(P. 259)**

**3 Click [External Interface Settings] ▶ [Edit].**

⇒ The [Edit External Interface Settings] screen is displayed.

**4 Clear the [Use as USB Device] checkbox, and click [OK].**

**5 Restart the machine. ▶Restarting the Machine(P. 87)**

⇒ The settings are applied.

## NOTE

- Even if you use this setting to restrict the use of the rear USB port, memory media can still be connected to the USB port on the rear of the machine. To also restrict USB connection of memory media, see the following.

▶ **Restricting Use of Memory Media(P. 234)**

## Configuring LPD, RAW, or WSD

9664-05W

Select whether to use any of the protocols below on the machine when printing documents from a computer. You are recommended to disable any protocols you will not be using. When using LPD or RAW, you can configure the time until reception of print data is canceled.

### LPD

This protocol is not dependent on the hardware, operating system, or other platform. It is commonly used in TCP/IP network environments.

### RAW

This is Windows' proprietary print data type protocol. It is used as standard in a Windows environment.

### WSD

This protocol enables automatic detection of network-connected printers in a Windows environment.

This section describes how to configure the settings using Remote UI from a computer.

On the control panel, select [Menu] in the [Home] screen, and then select [Preferences] to configure the settings. ▶ **[TCP/IP Settings](P. 295)**

Administrator privileges are required. The machine must be restarted to apply the settings.

- 1 Log in to Remote UI in System Manager Mode. ▶ Starting Remote UI(P. 256)**
- 2 On the Portal page of Remote UI, click [Settings/Registration]. ▶ Portal Page of Remote UI(P. 259)**
- 3 Click [Network Settings].**
- 4 Configure LPD, RAW, or WSD.**

### ■ When Configuring LPD

- 1** Click [LPD Settings] ▶ [Edit].  
 ▶▶ The [Edit LPD Settings] screen is displayed.
- 2** Set whether to use LPD.  
 When not using LPD, clear the [Use LPD Printing] checkbox, and proceed to step 5.
- 3** Enter the time in [RX Timeout].  
 Enter the time in minutes from the start of reception standby, after print data reception is canceled, to the timeout.

### ■ When Configuring RAW

- 1** Click [RAW Settings] ▶ [Edit].  
 ▶▶ The [Edit RAW Settings] screen is displayed.
- 2** Set whether to use RAW.  
 When not using RAW, clear the [Use RAW Printing] checkbox, and proceed to step 5.

- 3 Enter the time in [RX Timeout].  
Enter the time in minutes from the start of reception standby, after print data reception is canceled, to the timeout.

### ■ When Configuring WSD

- 1 Click [WSD Settings] ► [Edit].  
 ◻► The [Edit WSD Settings] screen is displayed.
- 2 Set whether to use WSD for each function.  
When not using WSD, clear the checkbox of the function for restricting use of WSD.

#### Using WSD to Print Data

Select the [Use WSD Printing] checkbox.

The [Use WSD Browsing] checkbox is selected automatically, and WSD is used to obtain the information of the machine from the computer.

#### When Responding to a Search Request of the Machine by Multicast Discovery

Select the [Use Multicast Discovery] checkbox.

To keep the machine in sleep mode without responding to received multicast discovery packets, clear the checkbox.



- 5 Click [OK].

- 6 Restart the machine. ◻► **Restarting the Machine(P. 87)**

◻► The settings are applied.

## NOTE

### Adding a WSD Network Device

- Click [] (Start) ► [] (Settings) ► [Devices] ► [Printers & scanners] ► [Add printers & scanners], and perform the operations following the instructions on the screen.
- For details about installing the driver via a WSD network, see the manual of the driver at the online manual site.

<https://oip.manual.canon/>

### Changing the Port Number

- To change the port number of each protocol, see the following:  
◻► **Changing the Port Number(P. 206)**

# Disabling HTTP Communication

---

9664-05X

It is recommended to disable HTTP communication when using only the USB connection or when not using functions that require HTTP communication, such as Remote UI, WSD printing, and AirPrint.

This section describes how to configure the settings using the control panel.

You can also configure the settings using Remote UI from a computer. [▶Managing the Machine from a Computer \(Remote UI\)\(P. 255\)](#)

Administrator privileges are required.

**1** On the control panel, select [Menu] in the [Home] screen, and press **OK**. [▶\[Home\] Screen\(P. 94\)](#)

**2** Press [Preferences] ▶ **OK** ▶ [Network] ▶ **OK** ▶ [TCP/IP Settings] ▶ **OK** ▶ [Use HTTP] ▶ **OK**.

⇒ The [Use HTTP] screen is displayed.

If the login screen appears, enter the System Manager ID and PIN, and then press **ID**. [▶System Manager ID and PIN\(P. 6\)](#)

**3** Press [Off] ▶ **OK** ▶ [Yes] ▶ **OK**.

# Restricting Use of the Control Panel



9664-05Y

By disabling the control panel keys, you can prevent the settings of the machine from being changed.

To set Key Lock of the control panel, use Remote UI from a computer. Administrator privileges are required.

- 1 Log in to Remote UI in System Manager Mode. ▶ Starting Remote UI(P. 256)**
- 2 On the Portal page of Remote UI, click [Settings/Registration]. ▶ Portal Page of Remote UI(P. 259)**
- 3 Click [Device Management] ▶ [Key Lock Settings] ▶ [Edit...].**
  - ⇒ The [Edit Key Lock Settings] screen is displayed.
- 4 Select the [Enable Key Lock] checkbox, and click [OK].**
  - ⇒ The settings are applied.
- 5 Log out from Remote UI.**

## NOTE

- Even when Key Lock is enabled, you can use the , , and  keys on the control panel.

# Applying a Security Policy

9664-060

Canon multifunction machines and printers have a security policy function for collectively configuring and managing multiple security settings according to a policy. You cannot edit the security policy with the machine, but you can apply a security policy that has been edited with another device or device management software.

- ▶ **Applying a Security Policy to the Machine(P. 246)**
- ▶ **Checking the Security Policy Applied to the Machine(P. 247)**

## Applying a Security Policy to the Machine

You can import a security policy exported from another device or the device management software to the machine and apply it.

\* If you cannot import a security policy exported from another machine to this machine, use the device management software.

Import the security policy using Remote UI from a computer. You cannot use the control panel to import it. Administrator privileges are required. When a security policy is imported, the machine restarts automatically.

### IMPORTANT

#### Do not turn OFF the machine until the import is complete.

- It may take a few minutes until the process is completed. Turning OFF the machine during processing may cause data corruption or damage the machine.

#### Do not operate the machine during import.

- Before import, check that the machine is not printing or performing other operations.

**1 Log in to Remote UI in System Manager Mode. ▶ Starting Remote UI(P. 256)**

**2 On the Portal page of Remote UI, click [Settings/Registration]. ▶ Portal Page of Remote UI(P. 259)**

**3 Click [Data Management] ▶ [Import].**

⇒ The [Import] screen is displayed.

**4 Click [Browse] in [File Path], and specify the file to be imported.**

Import the device configuration information file (\*.dcm).

**5 In [Decryption Password], enter the password set at export.**

**6 Select the [Settings/Registration] checkbox in [Select Item to Import].**

## 7 Click [Start Importing] ▶ [OK].

- ⇒ The security policy is imported to the machine.  
When the import is complete, the machine restarts automatically.

## 8 Click [OK].

## NOTE

### Exporting a Security Policy

- You can export the security policy applied to the machine and apply it to another device (Canon device that supports security policy setting). ▶ **Importing and Exporting the Settings(P. 268)**  
\* If you cannot import a security policy exported from another machine to this machine, use the device management software.

### Applying a Password-protected Security Policy

- When applying a security policy that is protected with a password from another device to the machine, the same password is set for the security policy on the machine. Thereafter, you can only import a security policy with the same password.  
\* The security policy exported from the machine is also set with the same password.

## Checking the Security Policy Applied to the Machine

You can check the security policy items and their usage.

Check the security policy using Remote UI from a computer. You cannot use the control panel to check this information.  
Administrator privileges are required.

## 1 Log in to Remote UI in System Manager Mode. ▶ Starting Remote UI(P. 256)

## 2 On the Portal page of Remote UI, click [Settings/Registration]. ▶ Portal Page of Remote UI(P. 259)

## 3 Click [Security Settings] ▶ [Confirm Security Policy].

- ⇒ The [Confirm Security Policy] screen is displayed.

## 4 Check the security policy items and their usage. ▶ Security Policy Items(P. 248)

## 5 Log out from Remote UI after viewing the usage.

# Security Policy Items

9664-061

You can check the security policy items and their usage from Remote UI on the [Confirm Security Policy] screen. The content set on another device or software is applied to the security policy for the machine. Therefore, there may be function items in the security policy that are not available on the machine, but these do not affect the settings or operation of the machine.

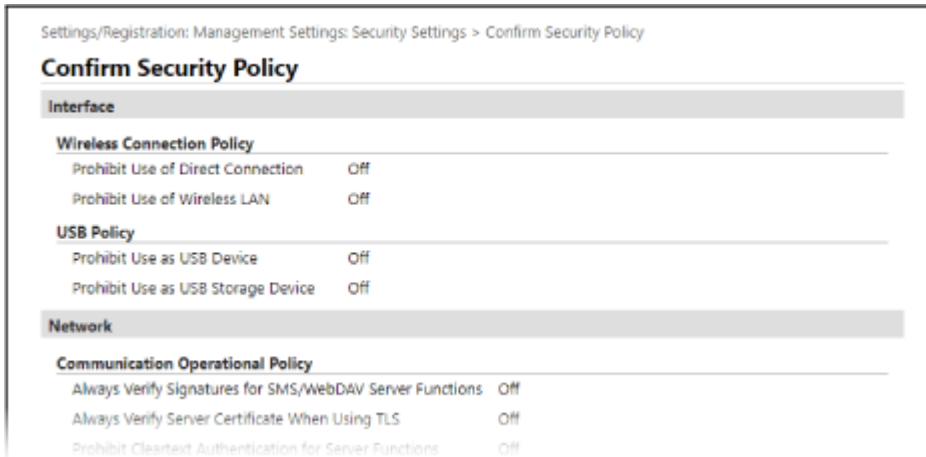

- ▶ [Interface](P. 248)
- ▶ [Network](P. 248)
- ▶ [Authentication](P. 250)
- ▶ [Key/Certificate](P. 250)
- ▶ [Log] (P. 251)
- ▶ [Job](P. 251)
- ▶ [Storage] (P. 251)

## [Interface]

### [Wireless Connection Policy]

You can disable the wireless connection to prevent unauthorized access.

#### [Prohibit Use of Direct Connection]

You can prohibit access from mobile devices. ▶ [Direct Connection Settings](P. 288)

#### [Prohibit Use of Wireless LAN]

You can prohibit wireless access via a wireless LAN router or access point. ▶ [Select Wired/Wireless LAN] (P. 288)

### [USB Policy]

You can disable the USB connection to prevent unauthorized access and data theft.

#### [Prohibit Use as USB Device]

You can prohibit a computer from connecting to the machine via the USB port. ▶ [USB Settings](P. 302)

#### [Prohibit Use as USB Storage Device]

You can prohibit the use of USB memory devices with the machine. ▶ [USB Settings](P. 302)

## [Network]

### [Communication Operational Policy]



You can require a signature or certificate verification for safer communication.

**[Always Verify Signatures for SMS/WebDAV Server Functions]**

As this function is not available on the machine, it is not applied to the security policy.

**[Always Verify Server Certificate When Using TLS]**

This verifies the certificate including Common Name (CN) when using TLS-encrypted communication.

\* This does not apply to communication with an IEEE 802.1X network.

**[Prohibit Cleartext Authentication for Server Functions]**

You can limit verification information to secure methods only. When you are using the machine as a server, cleartext authentication and functions using cleartext authentication are not available. ▶**[Dedicated Port Authentication Method](P. 290)**

\* If you are using an older version of the device management software or driver, you may not be able to connect to the machine. Use an updated version.

**[Prohibit Use of SNMPv1]**

You can prohibit use of SNMPv1 when obtaining device information from a computer. ▶**[SNMP Settings](P. 289)**

**[Port Usage Policy]**

You can close unused ports to prevent external intrusion.

**[Restrict LPD Port (Port Number: 515)]**

You can prohibit printing using the LPD protocol. ▶**[LPD Settings](P. 299)**

**[Restrict RAW Port (Port Number: 9100)]**

You can prohibit printing using the RAW protocol. ▶**[RAW Settings](P. 299)**

**[Restrict FTP Port (Port Number: 21)]**

As this function is not available on the machine, it is not applied to the security policy.

**[Restrict WSD Port (Port Number: 3702, 60000)]**

You can prohibit the use of functions using the WSD protocol. ▶**[WSD Settings](P. 299)**

**[Restrict BMLinkS Port (Port Number: 1900)]**

As this function is not available on the machine, it is not applied to the security policy.

**[Restrict IPP Port (Port Number: 631)]**

You can disable certain print functions that use mobile apps and prohibit related printing. ▶**[Linking with Mobile Devices](P. 171)**

**[Restrict SMB Port (Port Number: 137, 138, 139, 445)]**

As this function is not available on the machine, it is not applied to the security policy.

**[Restrict SMTP Port (Port Number: 25)]**

As this function is not available on the machine, it is not applied to the security policy.

**[Restrict Dedicated Port (Port Number: 9002, 9006, 9007, 9011-9015, 9017-9019, 9022, 9023, 9025, 20317, 47545-47547)]**

You can prohibit the use of dedicated ports. ▶**[Dedicated Port Settings](P. 290)**

**[Restrict Remote Operator's Software Port (Port Number: 5900)]**

As this function is not available on the machine, it is not applied to the security policy.

**[Restrict SIP (IP Fax) Port (Port Number: 5004, 5005, 5060, 5061, 49152)]**

As this function is not available on the machine, it is not applied to the security policy.

**[Restrict mDNS Port (Port Number: 5353)]**

You can disable mDNS settings (IPv4/IPv6) and certain print functions that use a mobile app. This disables network discovery and automatic settings using mDNS as well as related printing.

▶**[mDNS Settings](P. 296)**

▶ **Linking with Mobile Devices(P. 171)**

**[Restrict SLP Port (Port Number: 427)]**

You can disable response to discovery in Multicast Discovery Settings as well as network discovery and automatic settings using SLP. ▶ **Configuring SLP Communication(P. 74)**

**[Restrict SNMP Port (Port Number: 161)]**

You can prohibit the use of functions using the SNMP protocol. This prohibits the machine from obtaining device information from a computer using SNMP and configuring related settings.

▶ **[SNMP Settings](P. 289)**

## [Authentication]

**[Authentication Operational Policy]**

As this function is not available on the machine, it is not applied to the security policy.

**[Prohibit Guest Users to Use Device]**

**[Force Setting of Auto Logout]**

**[Password Operational Policy]**

As this function is not available on the machine, it is not applied to the security policy.

**[Prohibit Caching of Password for External Servers]**

**[Display Warning When Default Password Is in Use]**

**[Prohibit Use of Default Password for Remote Access]**

**[Password Settings Policy]**

As this function is not available on the machine, it is not applied to the security policy.

**[Minimum Number of Characters for Password]**

**[Password Validity Period]**

**[Prohibit Use of 3 or More Identical Consecutive Characters]**

**[Force Use of at Least 1 Uppercase Character]**

**[Force Use of at Least 1 Lowercase Character]**

**[Force Use of at Least 1 Digit]**

**[Force Use of at Least 1 Symbol]**

**[Lockout Policy]**

You can prohibit login for a while when the wrong password is entered a certain number of times in a row.

**[Enable Lockout]**

This enables Lockout. Set the Lockout threshold and Lockout period separately on the machine. ▶ **[Lockout Settings](P. 354)**

## [Key/Certificate]

By preventing weak encryption and encrypting user passwords and keys within a certain hardware, you can protect sensitive data.

**[Prohibit Use of Weak Encryption]**

You can prohibit the use of weak encryption.  **[Encryption Settings](P. 353)**

**[Prohibit Use of Key/Certificate with Weak Encryption]**

You can prohibit the use of keys and certificates with weak encryption.

**[Use TPM to Store Password and Key]**

As this function is not available on the machine, it is not applied to the security policy.

## [Log]

As this function is not available on the machine, it is not applied to the security policy.

**[Force Recording of Audit Log]**

**[Force SNMP Settings]**

## [Job]

**[Printing Policy]**

As this function is not available on the machine, it is not applied to the security policy.

**[Prohibit Immediate Printing of Received Jobs]**

**[Sending/Receiving Policy]**

As this function is not available on the machine, it is not applied to the security policy.

**[Allow Sending Only to Registered Addresses]**

**[Force Confirmation of Fax Number]**

**[Prohibit Auto Forwarding]**

## [Storage]

As this function is not available on the machine, it is not applied to the security policy.

**[Force Complete Deletion of Data]**

# Managing the Machine

<b>Managing the Machine</b> .....	253
<b>Setting the Date and Time</b> .....	254
<b>Managing the Machine from a Computer (Remote UI)</b> .....	255
Starting Remote UI .....	256
Portal Page of Remote UI .....	259
Checking Usage and Logs with Remote UI .....	261
<b>Monitoring the Usage</b> .....	263
Checking the Number of Printed Pages (Check Counter) .....	264
Printing and Viewing Reports and Lists .....	265
Changing the Report and List Print Settings .....	267
<b>Importing and Exporting the Settings</b> .....	268
<b>Updating the Firmware</b> .....	270
<b>Initializing the Settings and Data</b> .....	273

# Managing the Machine

---

This section describes the management functions that are required to operate the machine.

## Monitoring the Operation Status and Usage of the Machine, and Configuring the Settings

---

### Setting the Date and Time

Set the date and time for the machine. The date and time are used as the reference for the functions using date and time information, and therefore, they need to be set accurately.

▶ **Setting the Date and Time(P. 254)**

### Checking the Operation Status and Changing the Settings (Remote UI)

You can use a Web browser on a computer to check the operation status of the machine and change the machine settings. You can manage the machine from a remote location and efficiently perform time-consuming settings and registration on your computer.

▶ **Managing the Machine from a Computer (Remote UI)(P. 255)**

### Monitoring the Usage (Control Panel)

You can use the control panel of the machine to check the total number of printed pages and print the settings and other reports and lists.

▶ **Monitoring the Usage(P. 263)**

## Managing Servers, Various Data, and Firmware

---

### Managing the Settings of the Machine

You can use the import and export functions to regularly back up the settings. In addition, you can share the settings with other devices to save time on configuring the settings.

▶ **Importing and Exporting the Settings(P. 268)**

### Updating the Firmware

Update the firmware to add new functions to the machine and to fix bugs. By updating to the latest firmware, you can use the machine with more stable and comfortable operations.

▶ **Updating the Firmware(P. 270)**

### Initializing the Settings and Data

You can initialize all settings and data when replacing or disposing of the machine. Initializing the machine prevents access to confidential information and unauthorized use by third parties.

▶ **Initializing the Settings and Data(P. 273)**

## ■ See Also

For the settings required to operate the machine, such as the network settings, see the following:

▶ **Setting Up(P. 39)**

# Setting the Date and Time

9664-063

Set the date and time for the machine. The date and time set here are used as the reference for the functions using date and time information, and therefore, they need to be set accurately.

This section describes how to configure the settings using Remote UI from a computer.

On the control panel, select [Menu] in the [Home] screen, and then select [Preferences] to configure the settings. ▶  
[Timer/Energy Settings](P. 284)

## 1 Log in to Remote UI. ▶Starting Remote UI(P. 256)

## 2 On the Portal page of Remote UI, click [Settings/Registration]. ▶Portal Page of Remote UI(P. 259)

## 3 Click [Timer Settings] ▶ [Edit].

⇒ The [Edit Timer Settings] screen is displayed.

## 4 Enter the current date and time.

## 5 Set the time zone according to the region where the machine is used.

Communicating over the Internet is premised on setting the UTC (Coordinated Universal Time) correctly. The UTC is a coordinated universal time that is standard for all parts of the world. There is a time difference depending on the country or region where the machine is used.

## 6 Set daylight saving time as needed.

- Select the [Use Daylight Saving Time] checkbox if the machine is in a country or region with daylight saving time, and then set the start and end dates.

## 7 Click [OK].

⇒ The settings are applied.

## 8 Log out from Remote UI.

### NOTE

- Adjust the time regularly when the clock is noticeably incorrect.
- You can also specify to automatically synchronize the date and time with a server on the network using SNTP. ▶Configuring SNTP(P. 72)

# Managing the Machine from a Computer (Remote UI)

---

9664-064

With Remote UI, you can use a Web browser on a computer to check the function operation status of the machine and change the machine settings. You can manage the machine from a remote location and efficiently perform time-consuming settings and registration on your computer.

Remote UI has the following two modes. The functions available with Remote UI vary depending on the mode you logged in to.

- **System Manager Mode**  
You can use all functions of Remote UI.
- **General User Mode**  
You can monitor usage, view logs, cancel printing, and change some settings.

- ▶ **Starting Remote UI(P. 256)**
- ▶ **Portal Page of Remote UI(P. 259)**
- ▶ **Checking Usage and Logs with Remote UI(P. 261)**

## ■ See Also

It is recommended that you set up the following functions to prevent unauthorized use of Remote UI by a third party:

### **System Manager ID**

Set the System Manager ID, which is the exclusive administrator account, so that only users with the ID can log in to System Manager Mode.

- ▶ **Setting the Department ID and PIN for the Administrator(P. 191)**

### **Remote UI Access PIN**

If Department ID Management is not set up, configure this setting to require PIN entry when logging in to Remote UI so that only users with the PIN can use Remote UI.

- ▶ **Setting the PIN to Use for Remote UI(P. 239)**

# Starting Remote UI

9664-065

To use Remote UI, enter the IP address of the machine into a Web browser on a computer, and log in with System Manager Mode or General User Mode. The functions available with Remote UI vary depending on the mode you logged in to.

When Department ID Management is set up, you must log in with the Department ID. The mode to which you are logging in varies depending on the System Manager ID settings.

## Required Preparations

- Check the operating environment of Remote UI. [▶Supported Environment\(P. 34\)](#)
- Connect the computer you are using to operate Remote UI to the machine over a network. [▶Setting Up the Network\(P. 43\)](#)
- Check the IP address of the machine. [▶Checking the Network Status and Settings\(P. 76\)](#)

## 1 From a Web browser on a computer, access the following URL.

`http://<IP address of the machine>/`

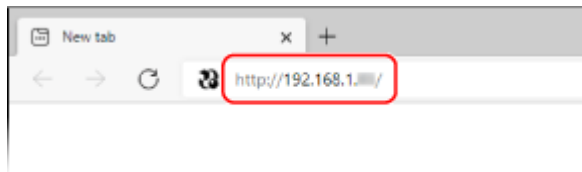

⇒ The Remote UI login screen appears.

When Remote UI communication is encrypted, a warning message about the security certificate may appear. If there are no problems with the certificate or TLS settings, you can continue operations.

When entering an IPv6 address, enclose the IP address in brackets [ ].

### Example:

`http://[fe80:2e9e:fcff:fe4e:dbce]/`

### ■ If the Remote UI Login Screen Is Not Displayed

When a message such as [Cannot access Remote UI.] is displayed and the login screen is not displayed, see the following:

- [▶Cannot Access Remote UI\(P. 440\)](#)

## 2 Enter the items required for login.

### ■ When Department ID Management is not set up

Select [System Manager Mode] or [General User Mode], and enter the required items according to the setting status.



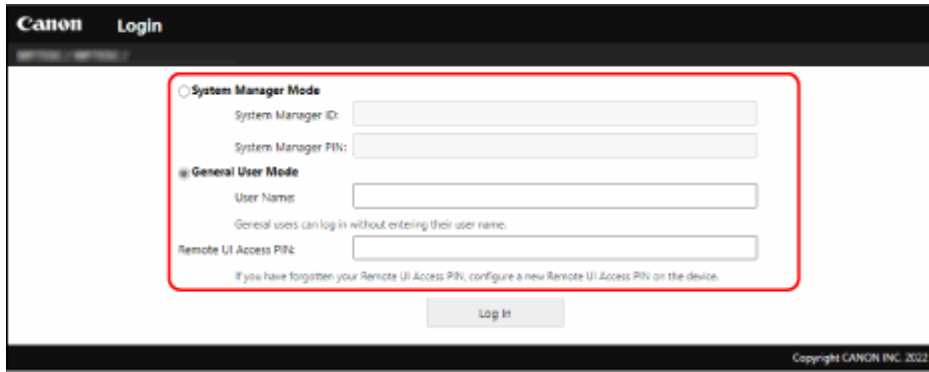

**[System Manager Mode]**

When the System Manager ID is set, enter the System Manager ID and System Manager PIN. **▶System Manager ID and PIN(P. 6)**

\* When logging in with System Manager Mode, you must change the System Manager PIN from the default setting. **▶Setting the Department ID and PIN for the Administrator(P. 191)**

**[General User Mode]**

You can log in without entering a user name, but enter a print user name when checking and canceling jobs waiting to be printed.

\* If a user name is not set in the printer driver, the logon user name of the computer that sent the print data is set automatically.

**[Remote UI Access PIN]**

When the Remote UI Access PIN is set, enter the PIN.

**■When Department ID Management is set**

Enter the Department ID and PIN.

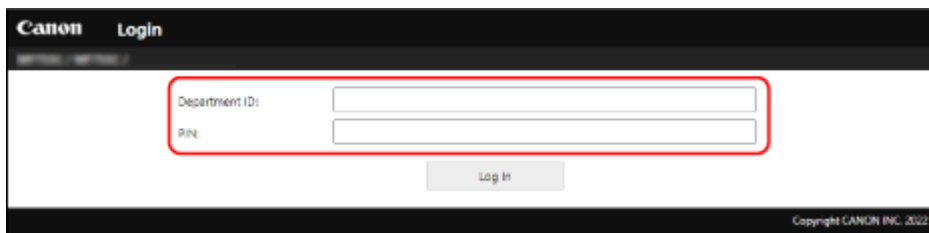

**When the System Manager ID is set**

When logging in with System Manager Mode, enter the System Manager ID and System Manager PIN. When a Department ID other than the System Manager ID is entered, you will log in with General User Mode.

**When the System Manager ID is not set**

No matter which Department ID is entered, you will log in with System Manager Mode. **▶System Manager ID and PIN(P. 6)**

\* When logging in with System Manager Mode, you must change the System Manager PIN from the default setting. **▶Setting the Department ID and PIN for the Administrator(P. 191)**

**3 Click [Log In].**

⇒ The Portal page of Remote UI appears. **▶Portal Page of Remote UI(P. 259)**

**4 When you have completed your operations, click [Log Out].**

⇒ The login screen appears after logging out from Remote UI.

**! IMPORTANT**

- Do not access other websites when using Remote UI.

## NOTE

### Setting the Time Until the User Is Automatically Logged Out

- The user is automatically logged out from Remote UI if no operations are performed for a certain period of time. Use the following procedure to set the time until the user is logged out.

Log in to Remote UI in System Manager Mode ▶ [Settings/Registration] ▶ [Network Settings] ▶ [Session Settings] ▶ [Edit] ▶ enter the time until the user is logged out ▶ [OK]

## Portal Page of Remote UI

9664-066

When you log in to Remote UI, the Portal page (Remote UI top page) appears. From here you can check the operations status of the machine, view various information, and change the settings with button operations.

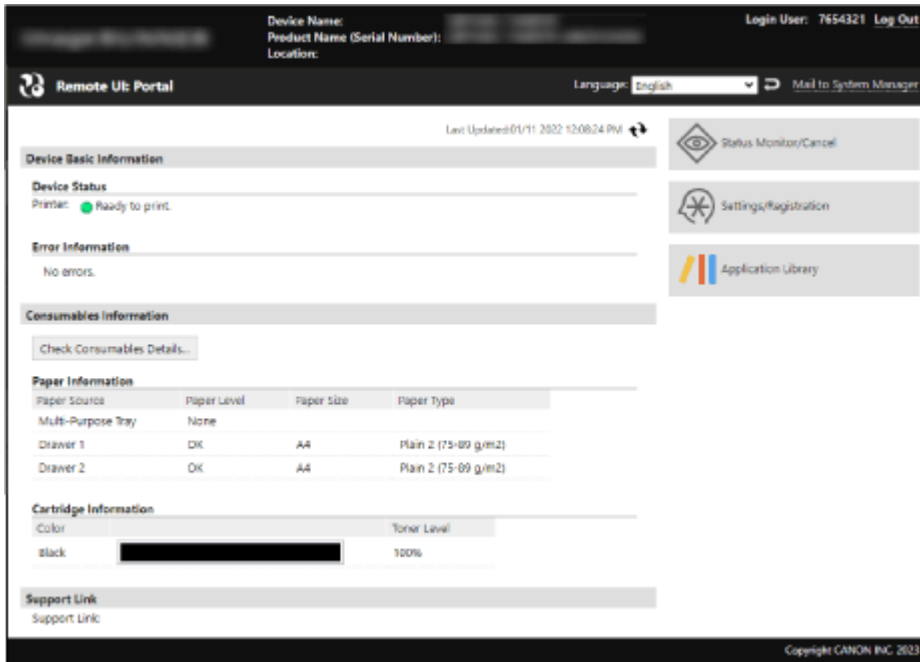

### [Device Name]

Displays the device name set in [Settings/Registration] ► [Device Management] ► [Device Information Settings].

### [Product Name]/[Product Name (Serial Number)]

Displays the product name of the machine.

Depending on the model, the serial number may also be displayed.

### [Location]

Displays the installation location set in [Settings/Registration] ► [Device Management] ► [Device Information Settings].

### [Login User]

Displays the information of the logged in user.

### [Log Out]

You are logged out of Remote UI, and the login screen is displayed.

### [Language]

You can change the display language of Remote UI.

\* The display languages of the computer and Remote UI must be the same. If the display languages are not the same, the entered information may not be displayed correctly, or you may not be able to reference a folder, server, or other specified destination.

### [Mail to System Manager]

Creates e-mail for the administrator indicated in [Settings/Registration] ► [User Management] ► [System Manager Information].

### [Last Updated]

Displays the date and time that the information displayed on the Portal page was last updated.

Click [ ↻ ] to the right of the date and time to update these.

### [Device Basic Information]

Displays the current status and error information of the machine.

When an error occurs, this displays a link to the error information screen.

**[Consumables Information]**

Displays the paper source information and remaining amount of ink in the toner cartridge. Click [Check Consumables Details] to display the toner cartridge name.

**[Support Link]**

Displays a link to support information for this machine that is set in [Settings/Registration] ▶ [License/Other] ▶ [Support Link].

**[Status Monitor/Cancel]**

Click this to display the [Status Monitor/Cancel] screen.

From here, you can check the status and logs of a function, operation status of the machine, and error information. ▶

**Checking Usage and Logs with Remote UI(P. 261)**

**[Settings/Registration]**

Click this to display the [Settings/Registration] screen.

If you logged in with System Manager Mode, you can change any settings and perform operations such as saving and importing data.

- The items that can be set in the [Settings/Registration] screen are nearly the same as those of the control panel, but some items can only be set with either the control panel or Remote UI. ▶ **Settings Menu Items(P. 277)**
- Depending on the item, you may have to restart the machine for the settings to be applied. If a restart is required, a message appears at the top of the screen.

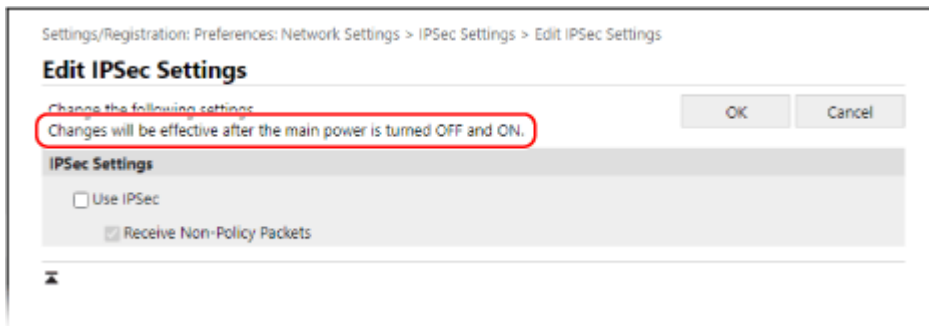

**[Application Library] (System Manager Mode only)**

Click this to display the setting screen for the Application Library.

For details about the Application Library, see the manual of the Application Library at the online manual site.

# Checking Usage and Logs with Remote UI

9664-067

From Status Monitor/Cancel in Remote UI, you can check the status and logs of a function, operation status of the machine, and error information.

- 1 Log in to Remote UI. ▶ Starting Remote UI(P. 256)
- 2 On the Portal page of Remote UI, click [Status Monitor/Cancel]. ▶ Portal Page of Remote UI(P. 259)
- 3 Select an item to view the status or log.

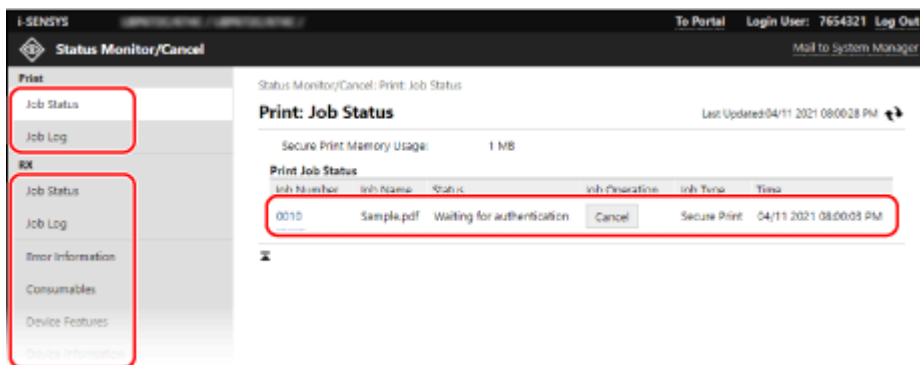

## [Print]

### [Job Status]

Displays the status (Printing or Waiting) of printed data from a computer.

This displays the status of all print jobs regardless of the Department ID Management setting.

If you entered your user name in [User Name] when you logged in with General User Mode, only the print job status for that user is visible.

- Click [Job Number] for paused prints and secure prints to display print details and view the user name and number of printed sheets.
- Click [Cancel] in [Job Operation] to delete the print data for jobs that are printing or waiting.

### [Job Log]

Displays the print job log from a computer.

## [RX]

### [Job Status]

Displays the RX job status for I-Fax jobs.

### [Job Log]

Displays the RX job log for I-Fax jobs.

## [Error Information]

Displays information of errors occurring on the machine.

\* You can view the same information by clicking the link displayed in [Error Information] on the Portal page.

## [Consumables]

Displays the paper size and type of each paper source and the toner cartridge name.

\* You can view the same information by clicking [Check Consumables Details] on the Portal page.

**[Device Features]**

Displays the specifications of the machine and the status of optional equipment.

**[Device Information]**

Displays information of the machine, such as the product name and serial number, as well as the firmware version and system manager information.

- [Device Name] and [Location] display the information set in [Settings/Registration] ► [Device Management] ► [Device Information Settings].
- [System Manager Information] displays the information set in [Settings/Registration] ► [User Management] ► [System Manager Information].

**[Check Counter]**

Displays the total number of pages printed to date. ► **Checking the Number of Printed Pages (Check Counter)(P. 264)**

**[Cartridge Log]**

Displays a usage record for the toner cartridge.

**[Eco Information]**

Displays the average number of sheets output and average power consumption per month.

**4 Log out from Remote UI after viewing the usage.**

## Monitoring the Usage

---

9664-068

You can use the control panel of the machine to check the total number of printed pages and print the machine settings and other reports and lists.

- ▶ **Checking the Number of Printed Pages (Check Counter)(P. 264)**
- ▶ **Printing and Viewing Reports and Lists(P. 265)**

### ■ See Also

You can also check the counter using Remote UI from a computer. In Remote UI, you can also check the status and logs of a function, operation status of the machine, and error information.

- ▶ **Checking Usage and Logs with Remote UI(P. 261)**

## Checking the Number of Printed Pages (Check Counter)

9664-069

You can display a counter showing the total number of pages printed to date.  
The number of printed pages includes printed reports and lists.

This section describes how to check the number of printed pages using the control panel.  
You can also check this information using Remote UI from a computer. [▶ Checking Usage and Logs with Remote UI\(P. 261\)](#)

### 1 Press on the control panel. [▶ Control Panel\(P. 14\)](#)

⇒ The [Status Monitor] screen is displayed.

### 2 Press [Device Status] ▶ ▶ [Check Counter] ▶ .

⇒ The [Check Counter] screen is displayed.

### 3 Select the item you want to check, and press .

### 4 Check the number of printed pages.

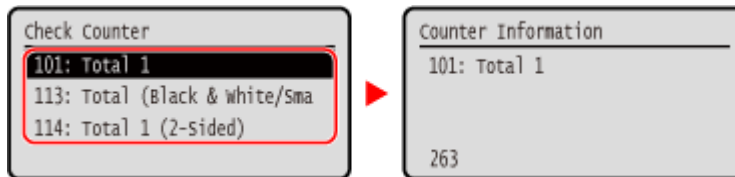

#### [101: Total 1]

Displays the total number of pages printed.

#### [113: Total (Black & White/Small)]

Displays the total number of pages printed in black and white.

#### [114: Total 1 (2-Sided)]

Displays the total number of pages printed with 2-sided.



# Printing and Viewing Reports and Lists

9664-06A

You can print and view reports and lists including machine usage and settings.

▶ **Types of Reports and Lists(P. 265)**

▶ **Printing Reports and Lists(P. 266)**

## NOTE

### 2-Sided Printing of Reports and Lists

- Reports and lists are printed on paper on one side by default. You can change the setting to print on both sides. ▶ **Changing the Report and List Print Settings(P. 267)**

## Types of Reports and Lists

### Machine Usage Reports

You can print and view the following reports related to usage of the machine including power consumption and status of consumables:

- **Eco Report**  
Displays the number of printed pages and power consumption per month. You can see how to save paper and power based on this information.
- **Consumables Status Report**  
Displays the status of consumables installed in the machine.
- **PCL Font List**  
Displays the fonts available in PCL mode.
- **PS Font List (LBP246dw)**  
Displays the fonts available in PS mode.
- **Cartridge Log Report**  
Displays a log of toner cartridge usage.
- **Department ID Management Report**  
Displays the number of printed pages and other usage for each Department ID when Department ID Management is enabled.

### Settings Lists

You can print and view the following lists that summarize the registration information and settings of the machine:

- **User Data List**  
Displays the serial number and other machine information as well as the settings that do not require administrator privileges.
- **System Manager Data List**  
Displays the serial number and other machine information as well as the settings that require administrator privileges.
- **IPSec Policy List**  
Displays the settings of the IPSec policies registered to the machine.

## Printing Reports and Lists

Print reports and lists using the control panel. You cannot print these using Remote UI from a computer. Administrator privileges are required to print the following reports and lists:

- Department ID Management Report
- System Manager Data List
- IPSec Policy List

**1** On the control panel, select [Menu] in the [Home] screen, and press **OK**. **▶**[Home] Screen(P. 94)

**2** Press [Output Reports] **▶** **OK** **▶** [Print List] **▶** **OK**.

**3** Select the report or list to print.

⇒ A screen confirming the paper available for printing is displayed.

If the login screen appears, enter the System Manager ID and PIN, and then press **ID**. **▶**System Manager ID and PIN(P. 6)

**4** Check that printable paper is set in the machine, select [Yes], and press **OK**.

⇒ The report or list is printed.

# Changing the Report and List Print Settings

---

9664-06C

Reports and lists are printed on paper on one side by default. You can change the setting to print on both sides.

Use the control panel to configure the settings. You cannot configure the settings using Remote UI from a computer.

**1** On the control panel, select [Menu] in the [Home] screen, and press **OK**. **▶**[Home] Screen(P. 94)

**2** Press [Output Reports] **▶** **OK** **▶** [Report Settings] **▶** **OK**.

⇒ The [Report Settings] screen is displayed.

**3** Select [Default Settings for Report Output] and press **OK**.

⇒ The [Default Settings for Report Output] screen is displayed.

**4** Press [2-Sided Printing] **▶** **OK** **▶** [On] **▶** **OK**.

# Importing and Exporting the Settings

9664-06E

You can write the settings to files and save (export) them to a computer. You can also load an exported file and apply (import) the settings to the machine.

You can use the import and export functions to back up the settings in case of an accident.

In addition, an exported file can be imported to another device<sup>\*1</sup> to enable sharing of the settings with another device without having to configure settings.

Some items cannot be imported or exported. [▶Settings that Can Be Imported and Exported\(P. 355\)](#)

<sup>\*1</sup> The settings of the machine can only be applied to the same model.

[▶Exporting the Settings\(P. 268\)](#)

[▶Importing the Settings\(P. 269\)](#)

## IMPORTANT

### Do Not Turn OFF the Machine until the Import or Export Is Complete.

- It may take a few minutes until the process is completed. Turning OFF the machine during processing may cause data corruption or damage the machine.

### Do Not Operate the Machine during Import or Export.

- Before import or export, check that the machine is not printing or performing other operations.

## Exporting the Settings

Select the items to export and write them to a file.

This section describes how to export the settings using Remote UI from a computer.

On the control panel, select [Menu] in the [Home] screen, and then select [Management Settings] to export. When exporting from the control panel, use a USB memory device. [▶\[Import/Export\]\(P. 351\)](#)  
Administrator privileges are required.

**1** Log in to Remote UI in System Manager Mode. [▶Starting Remote UI\(P. 256\)](#)

**2** On the Portal page of Remote UI, click [Settings/Registration]. [▶Portal Page of Remote UI\(P. 259\)](#)

**3** Click [Data Management] ▶ [Export].

⇒ The [Export] screen is displayed.

**4** In [Encryption Password], set a password.

- Enter the same password in [Encryption Password] and [Confirm] using single-byte alphanumeric characters.
- A password is required to import exported data.

**5 Click [Start Exporting] to save the exported data as a file to a computer.**

**6 Log out from Remote UI.**

## Importing the Settings

Specify the exported file and select the items to be imported.  
The device configuration information file (\*.dcm) is available for the file format to import.

This section describes how to import files using Remote UI from a computer.  
On the control panel, select [Menu] in the [Home] screen, and then select [Management Settings] to import. When importing from the control panel, use a USB memory device. [▶\[Import/Export\]\(P. 351\)](#)  
Administrator privileges are required. Depending on the items to be imported, the machine restarts automatically.

**1 Log in to Remote UI in System Manager Mode. [▶Starting Remote UI\(P. 256\)](#)**

**2 On the Portal page of Remote UI, click [Settings/Registration]. [▶Portal Page of Remote UI\(P. 259\)](#)**

**3 Click [Data Management] ▶ [Import].**

⇒ The [Import] screen is displayed.

**4 Click [Browse] in [File Path], and specify the file to be imported.**

**5 Enter the decryption password.**

Enter the password set at export.

**6 Click [Start Importing] ▶ [OK].**

⇒ The selected file is imported to the machine.

**7 When the screen indicating that importing has completed appears, click [OK].**

**8 Log out from Remote UI.**

# Updating the Firmware

When functions are added or the software version is upgraded, the firmware of the machine is updated. Check the version of the firmware, and update the firmware via the Internet or a computer according to the usage environment of the machine.

✓ : Can be updated    — : Cannot be updated

Usage environment of the machine	Connection via Internet	Connection via computer
Wired LAN connection	✓	✓
Wireless LAN connection	✓	—
USB connection	—	✓
Use IPv6	—	—

\* You cannot update the firmware in an IPv6 Environment. Connect the machine to a computer via USB, and update from the computer.

- ▶ **Checking the Firmware Version(P. 270)**
- ▶ **Updating the Firmware via the Internet(P. 271)**
- ▶ **Updating the Firmware via a Computer(P. 271)**

## Checking the Firmware Version

Check the current version of the firmware before updating it, and then check the version after updating to see if the update was performed correctly.

This section describes how to check the firmware version using the control panel. You can also use Remote UI from a computer to check the firmware version. ▶ **Managing the Machine from a Computer (Remote UI)(P. 255)**  
Administrator privileges are required.

- 1** On the control panel, select [Menu] in the [Home] screen, and press **OK**. ▶ [Home] Screen(P. 94)
- 2** Press [Management Settings] ▶ **OK** ▶ [Remote UI Settings/Update Firmware] ▶ **OK** ▶ [Update Firmware] ▶ **OK**.
  - ⇒ The [Update Firmware] screen is displayed.

If the login screen appears, enter the System Manager ID and PIN, and then press **ID**. ▶ **System Manager ID and PIN(P. 6)**
- 3** Select [Version Information] and press **OK**.
  - ⇒ Displays the current version of the firmware.

## Updating the Firmware via the Internet

Use the control panel to update the firmware via the Internet. You cannot update it using Remote UI from a computer. Administrator privileges are required. When the firmware has been updated, the machine restarts automatically.

### Required Preparations

- Connect the machine to the Internet. ▶ **Setting Up the Network(P. 43)**

### 1 On the control panel, select [Update Firmware] in the [Home] screen, and press **OK**. ▶ **[Home] Screen(P. 94)**

⇒ The machine accesses the Canon server to see if new firmware is available.

When [This is the latest firmware version.] appears, no update is available.

If the login screen appears, enter the System Manager ID and PIN, and then press **ID**. ▶ **System Manager ID and PIN(P. 6)**

### 2 In the licensing screen, select [Yes], and press **OK**.

⇒ The firmware update confirmation screen is displayed.

### 3 Press **OK**.

⇒ Downloading of the firmware starts.

When the download is complete, the machine restarts automatically, and the firmware is updated.

## IMPORTANT

- Do not turn OFF the machine until the restart is complete.

## Updating the Firmware via a Computer

Update the firmware from a computer connected to the machine via wired LAN or USB.

### Required Preparations

- Download the latest firmware from the Canon website for your country/region to the computer performing the update.  
**<https://global.canon/en/support/>**

### ■ How to Update from a Computer

See the "User Support Tool Operation Guide" included with the firmware.

## ■ To Put the Machine into Update Waiting State (Download Mode)

Use the following procedure.

Use the control panel to perform this operation. You cannot perform this operation using Remote UI from a computer. Administrator privileges are required.

**1** On the control panel, select [Menu] in the [Home] screen, and press **OK**. **▶**[Home] Screen(P. 94)

**2** Press [Management Settings] **▶** **OK** **▶** [Remote UI Settings/Update Firmware] **▶** **OK** **▶** [Update Firmware] **▶** **OK**.

⇒ The [Update Firmware] screen is displayed.

If the login screen appears, enter the System Manager ID and PIN, and then press **ID**. **▶**System Manager ID and PIN(P. 6)

**3** Press [Via PC] **▶** **OK** **▶** [Yes] **▶** **OK**.

⇒ Switches the machine to download mode and puts it into update waiting state.



# Initializing the Settings and Data

9664-06H

You can initialize the settings and registered data to reset the machine to the factory settings. You can initialize specified settings and data only or initialize all settings and data.

## Initializing Specific Settings and Data

You can initialize the following items separately:

- Settings menu: Initializes the settings of [Menu] in the [Home] screen.
- Key and Certificate: Initializes the settings of the key and certificate as well as CA certificate, and clears everything except the pre-installed key and certificate.

### ▶ Initializing Specific Settings and Data(P. 273)

## Initializing All Settings and Data

You can reset all settings to the factory settings, and clear all stored data including logs. Initialization is performed to prevent access to confidential information and unauthorized use such as when replacing or disposing of the machine.

### ▶ Initializing All Settings and Data(P. 274)

## Initializing Specific Settings and Data

This section describes how to initialize settings and data using Remote UI from a computer.

On the control panel, select [Menu] in the [Home] screen, and then perform initialization from [Preferences] or [Management Settings]. ▶[Initialize Network Settings](P. 292) / ▶[Data Management](P. 351)

Administrator privileges are required. Depending on the item to be initialized, you may have to restart the machine.

### 1 Log in to Remote UI in System Manager Mode. ▶Starting Remote UI(P. 256)

### 2 On the Portal page of Remote UI, click [Settings/Registration]. ▶Portal Page of Remote UI(P. 259)

### 3 Click [Data Management].

⇒ The [Data Management] screen is displayed.

### 4 Select the item to initialize.

#### ■ Initializing the Settings Menu

Click [Initialize Menu], and select the setting to be initialized from [Menu to Initialize].

#### ■ When Initializing a Key and Certificate

Click [Initialize Key and Certificate].

### 5 Click [Initialize] ▶ [OK].

⇒ The specified item is initialized.

### 6 Log out from Remote UI.

### ■ When the Settings Menu Is Initialized

When any of the following is initialized, restart the machine to apply the initialized settings. **▶ Restarting the Machine(P. 87)**

- [Preferences]
- [Function Settings]
- [Management Settings]
- [Network Settings]

## NOTE

### When Initializing a Key and Certificate

- Functions using a key and certificate such as TLS or IKE of IPsec are disabled. To use these functions again, you must set the key and certificate, and then enable the function.

### When [Management Settings] of the Settings Menu Is Initialized

- This also initializes the Remote UI Access PIN. To use Remote UI, you must set the Remote UI Access PIN again. **▶ Setting the PIN to Use for Remote UI(P. 239)**

## Initializing All Settings and Data

Use the control panel to initialize all settings and data. You cannot initialize these using Remote UI from a computer. Administrator privileges are required. When these are initialized, the machine restarts automatically.

## ! IMPORTANT

- Before initialization, check that there is no data being processed or waiting to be processed. This data is deleted when the initialization is performed.

**1** On the control panel, select [Menu] in the [Home] screen, and press **OK**. **▶ [Home] Screen(P. 94)**

**2** Press [Management Settings] **▶ OK ▶ [Initialize All Data/Settings] ▶ OK**.

⇒ The initialization confirmation screen is displayed.

If the login screen appears, enter the System Manager ID and PIN, and then press **ID**. **▶ System Manager ID and PIN(P. 6)**

**3** Press **OK ▶ [Yes] ▶ OK**.

⇒ All settings and data are initialized.

When initialization is complete, the machine restarts automatically.

# Settings Menu Items

<b>Settings Menu Items</b> .....	277
<b>[Preferences]</b> .....	278
[Display Settings] .....	280
[Timer/Energy Settings] .....	284
[Network] .....	288
[Wireless LAN Settings] .....	293
[TCP/IP Settings] .....	295
[External Interface] .....	302
[Accessibility] .....	303
[Volume Settings] .....	305
<b>[Adjustment/Maintenance]</b> .....	307
[Adjust Image Quality] .....	308
[Special Processing] .....	310
[Maintenance] .....	315
<b>[Function Settings]</b> .....	316
[Common] .....	318
[Paper Feed Settings] .....	319
[Print Settings] .....	321
[Printer] .....	322
[Printer Settings] .....	323
[PDL Selection (Plug and Play)] .....	339
[Receive] .....	340
[Common Settings] .....	341
[E-Mail Settings] .....	342
<b>[Management Settings]</b> .....	343
[User Management] .....	345
[Device Management] .....	346
[Remote UI Settings/Update Firmware] .....	349
[Remote UI Settings] .....	350
[Data Management] .....	351
[Security Settings] .....	353
[Authentication/Password Settings] .....	354
<b>Settings that Can Be Imported and Exported</b> .....	355
[Preferences] .....	356
[Adjustment/Maintenance] .....	360

## Settings Menu Items

[Function Settings] .....	361
[Management Settings] .....	363

# Settings Menu Items

---

9664-06J

This section describes the items available in the settings menu displayed when you press [Menu] in the [Home] screen on the control panel.

From the settings menu, you can run functions and modify the settings according to the machine's operating environment or its usage.

Administrator privileges are required to view or change some settings. Note also that the machine may need to be restarted for changed settings to take effect.

▶[Preferences](P. 278)

▶[Adjustment/Maintenance](P. 307)

▶[Function Settings](P. 316)

▶[Management Settings](P. 343)

### Support for Importing and Exporting Setting Data

The settings menu items can be used with the Import and Export functions to regularly back up your settings or share them with other machines.

Check this list to see which settings can be imported and exported.

▶**Settings that Can Be Imported and Exported(P. 355)**

## ■ See Also

### If a Login Screen Appears

If a System Manager ID has been set, a login screen may appear when certain items are selected. Once you enter the required information and the login is authenticated, you can view or change the settings.

▶**Logging In to the Machine(P. 103)**

### If the Machine Must be Restarted

After changing the settings, restart the machine.

▶**Restarting the Machine(P. 87)**

### Settings Not Included in the Menus

The Paper Settings items appear when you press [Paper Settings] in the [Home] screen.

▶**Specifying the Paper Size and Type(P. 119)**

### Configuring Settings from Remote UI

The settings menu items can also be specified from a computer using Remote UI. In Remote UI, specify the settings from [Settings/Registration] in the Portal page.

The items that can be specified in [Settings/Registration] in Remote UI are almost identical to those in the control panel settings menu, but there are also items that can be specified only from the control panel or only from Remote UI. Note also that some of the item names differ in Remote UI.

▶**Managing the Machine from a Computer (Remote UI)(P. 255)**

### Checking the Settings

You can check a list of the current settings by printing them out.

▶**Printing and Viewing Reports and Lists(P. 265)**

## [Preferences]

These are settings used to configure features such as the control panel screen displays and the network settings according to the environment in which the machine is used.

\* Values in bold red text indicate the default setting for each item.

- ▶ [Display Settings](P. 278)
- ▶ [English Keyboard Layout](P. 278)
- ▶ [Timer/Energy Settings](P. 278)
- ▶ [Network](P. 278)
- ▶ [External Interface](P. 278)
- ▶ [Accessibility](P. 279)
- ▶ [Volume Settings](P. 279)

### [Display Settings]

[Menu] ▶ [Preferences]

Configure the control panel screen displays.

- ▶ [Display Settings](P. 280)

### [English Keyboard Layout]

[Menu] ▶ [Preferences]

Specify the layout for a USB keyboard connected to the machine.

[USA Layout]
[UK Layout]

### [Timer/Energy Settings]

[Menu] ▶ [Preferences]

Set the date and time and specify the Energy Saver settings.

- ▶ [Timer/Energy Settings](P. 284)

### [Network]

[Menu] ▶ [Preferences]

Configure the network environment for the machine.

- ▶ [Network](P. 288)

### [External Interface]

[Menu] ▶ [Preferences]

Configure the USB connection.

- ▶ [External Interface](P. 302)

## [Accessibility]

[Menu] ▶ [Preferences]

Configure control panel screen features such as screen color inversion and message display time to make the screen easier to see.

🔍 **[Accessibility](P. 303)**

## [Volume Settings]

[Menu] ▶ [Preferences]

Set whether sounds are emitted.

🔍 **[Volume Settings](P. 305)**

## [Display Settings]

9664-06L

Configure the control panel screen displays.

\* Values in bold red text are the default settings for each item.

- ▶ **[Default Screen after Startup/Restoration]**  
(P. 280)
- ▶ **[Button Display Order on Home Screen]**(P. 280)
- ▶ **[Language]**(P. 280)
- ▶ **[Remote UI Language]**(P. 281)
- ▶ **[Millimeter/Inch Entry Switch]**(P. 282)
- ▶ **[Displ. Timing for Cartridge Prep. Notif.]**  
(P. 282)
- ▶ **[Display Notif. to Clean Fixing Assembly]**  
(P. 282)
- ▶ **[Show Warnings]**(P. 283)
- ▶ **[Action When Warning]**(P. 283)
- ▶ **[Display IP Address]**(P. 283)

### [Default Screen after Startup/Restoration]

[Menu] ▶ [Preferences] ▶ [Display Settings]

Specify the screen displayed after the start screen appears when the machine is turned ON and immediately after an Auto Reset.

<p><b>[Home]</b> [Secure Print] [Status Monitor]</p>
--

### [Button Display Order on Home Screen]

[Menu] ▶ [Preferences] ▶ [Display Settings]

Rearrange the buttons or change the display order of the items so that you can run frequently used functions more quickly from the [Home] screen of the control panel. ▶ **Customizing the [Home] Screen(P. 102)**

### [Language]

[Menu] ▶ [Preferences] ▶ [Display Settings]

Change the language shown on the control panel and used in printed reports.

\* Depending on your country or region, the [Language] setting may not be available, or its content or default setting may be different.



[Català]  
[Čeština]  
[Dansk]  
[Deutsch]  
[Eesti]  
**[English]**  
[Español]  
[Euskara]  
[Français]  
[Hrvatski]  
[Italiano]  
[Latviešu]  
[Lietuvių]  
[Magyar]  
[Nederlands]  
[Norsk]  
[Polski]  
[Português]  
[Română]  
[Slovenčina]  
[Slovenščina]  
[Suomi]  
[Svenska]  
[Türkçe]  
[Ελληνικά]  
[Български]  
[Русский]  
[Українська]  
[العربية]  
[日本語]  
[中文(繁體)]  
[中文(简体)]  
[한국어]

## [Remote UI Language]

[Menu] ► [Preferences] ► [Display Settings]

Change the language shown on Remote UI screens.

\* Depending on your country or region, the [Remote UI Language] setting may not be available, or its content or default setting may be different.

[English]  
 [Japanese]  
 [French]  
 [Spanish]  
 [German]  
 [Italian]  
 [Dutch]  
 [Finnish]  
 [Portuguese]  
 [Norwegian]  
 [Swedish]  
 [Danish]  
 [Czech]  
 [Hungarian]  
 [Russian]  
 [Turkish]  
 [Polish]  
 [Chinese (Simplified)]  
 [Chinese (Traditional)]  
 [Korean]

## [Millimeter/Inch Entry Switch]

[Menu] ► [Preferences] ► [Display Settings]

Change the units shown on the screen for entering length and width.

[Millimeter]  
 [Inch]

## [Displ. Timing for Cartridge Prep. Notif.]

[Menu] ► [Preferences] ► [Display Settings]

When the toner in a toner cartridge runs low, a message appears notifying you to prepare a new toner cartridge. To manually specify when this message appears (the toner level in a cartridge), specify the timing in [Custom]. When [Auto] is enabled, the machine automatically decides when to display the message.

[Auto]  
 [Custom]  
 2 to **20** to 99 (%)

## [Display Notif. to Clean Fixing Assembly]

[Menu] ► [Preferences] ► [Display Settings]

Select whether to notify you by displaying a message when the fixing assembly requires cleaning.

[Off]  
 [On]  
 [1000 to 50000]

## [Show Warnings]

[Menu] ▶ [Preferences] ▶ [Display Settings]

Specify whether a notification message is displayed when a toner cartridge is low on toner.

\* If the machine is configured to stop printing when a toner cartridge is low on toner, this cannot be set to [Off]. ▶ **[Action When Warning](P. 283)**

\* If the machine is configured not to print incoming I-Faxes when a toner cartridge is low on toner, the message appears even when this is set to [Off]. ▶ **[Continue Print. When Amount in Cart. Low](P. 341)**

[Low Cartridge Level] [Off] <b>[On]</b>
---

## [Action When Warning]

[Menu] ▶ [Preferences] ▶ [Display Settings]

Specify whether to continue printing when a toner cartridge is low on toner.

If this is set to [Stop Printing], a notification message appears when the toner cartridge runs low on toner. ▶ **[Show Warnings](P. 283)**

[Low Cartridge Level] <b>[Continue Printing]</b> [Stop Printing]
--

## [Display IP Address]

[Menu] ▶ [Preferences] ▶ [Display Settings]

Specify whether to display the machine's IPv4 address in the [Status Monitor] screen. ▶ **[Status Monitor Screen](P. 95)**

[Off] <b>[On]</b>
----------------------

## [Timer/Energy Settings]

Set the date and time and specify the Energy Saver settings.

\* Values in bold red text are the default settings for each item.

- ▶ [Current Date/Time Settings](P. 284)
- ▶ [Date/Time Settings](P. 284)
- ▶ [Date Format](P. 285)
- ▶ [Time Format](P. 285)
- ▶ [Auto Reset Time](P. 285)
- ▶ [Function After Auto Reset](P. 285)
- ▶ [Auto Shutdown Time](P. 286)
- ▶ [Auto Sleep Time](P. 286)
- ▶ [Auto Sleep Daily Timer](P. 286)
- ▶ [Sleep Mode Exit Time Settings](P. 286)

### [Current Date/Time Settings]

[Menu] ▶ [Preferences] ▶ [Timer/Energy Settings]

Set the date and time for the machine. The date and time set here are used as a reference for the functions that use date and time information. ▶ **Setting the Date and Time(P. 254)**

Before configuring this setting, check that the correct time zone is selected. ▶ [Date/Time Settings](P. 284)

\* The current date and time cannot be changed for one hour after Daylight Saving Time is set.

### [Date/Time Settings]

[Menu] ▶ [Preferences] ▶ [Timer/Energy Settings]

Set the time zone (UTC\*<sup>1</sup>) and Daylight Saving Time according to the region where the machine is installed.

\*<sup>1</sup> The UTC (Coordinated Universal Time) is a coordinated universal time that is standard for all parts of the world. Internet-based communication relies on the UTC being set correctly.

\* Depending on your country or region, the [Date/Time Settings] setting may not be displayed, or its content or default setting may be different.

\* When you change the time zone, the current time setting is automatically changed accordingly. ▶ [Current Date/Time Settings](P. 284) .

\* If daylight saving time is enabled, specify the dates from which and to which daylight saving time is in effect.

[Time Zone]

[(UTC-12:00) International Date Line West] to [(**UTC Coordinated Universal Time**)] to [(UTC+14:00) Kiritimati Island]

[Daylight Saving Time Settings]

[Off]

[**On**]

[Start]: Month, Week, Day

[End]: Month, Week, Day

## [Date Format]

[Menu] ▶ [Preferences] ▶ [Timer/Energy Settings]

Set the order in which the year, month, and day are displayed.

\* Depending on your country or region, the [Date Format] setting may not be available, or its content or default setting may be different.

[YYYY MM/DD]  
[MM/DD/YYYY]  
[DD/MM YYYY]

## [Time Format]

[Menu] ▶ [Preferences] ▶ [Timer/Energy Settings]

Set 12 Hour or 24 Hour as the format for displayed time.

[12 Hour (AM/PM)]  
[24 Hour]

## [Auto Reset Time]

[Menu] ▶ [Preferences] ▶ [Timer/Energy Settings]

If the control panel is not used for a set period, a function called “Auto Reset Time” automatically restores the default settings. This setting specifies whether Auto Reset is invoked.

If you enable Auto Reset, you can then set the time after which it is triggered.

\* You can also change the screen that is displayed after an Auto Reset. ▶[Function After Auto Reset](P. 285)

0 (Off)  
1 to 2 to 9 (min.)

## NOTE

### Situations Where Auto Reset is Not Triggered

- When the Error lamp on the control panel is flashing ▶Control Panel(P. 14)
- When the [Menu] screen or an error message\*<sup>1</sup> is displayed on the control panel
- When processing of some sort (such as printing) is in progress

\*<sup>1</sup> Auto Reset is performed for some messages.

## [Function After Auto Reset]

[Menu] ▶ [Preferences] ▶ [Timer/Energy Settings]

Set the screen displayed after an Auto Reset.

- To view the specified screen, set to [Default Function]. Specify the displayed screen in [Default Screen After Startup/Restoration]. ▶[Default Screen after Startup/Restoration](P. 280)

- To display the screen for the function being used before the Auto Reset, set to [Selected Function].

[Default Function]  
[Selected Function]

## [Auto Shutdown Time]

[Menu] ▶ [Preferences] ▶ [Timer/Energy Settings]

Set a timer to automatically shut down the machine after a specified period of idle time has elapsed since the machine entered the sleep mode.

\* When the [Auto Shutdown Time] setting is enabled, the machine may automatically shut down even if you are operating the machine from Remote UI. A malfunction may occur, particularly if the machine shuts down while data is being imported. When you import data using Remote UI, set [Auto Shutdown Time] to [Off] in advance.

\* If any settings of the [Timer Settings] are changed from Remote UI while the machine is in the sleep mode, the timer for the [Auto Shutdown Time] setting is reset to the beginning. The machine automatically shuts down after a specified period of idle time has elapsed since the timer was reset.

\* Depending on your country or region, the [Auto Shutdown Time] setting may not be available, or its content or default setting may be different.

0 (Off)  
1 to 4 to 8 (hr.)

## [Auto Sleep Time]

[Menu] ▶ [Preferences] ▶ [Timer/Energy Settings]

Set the time after which the machine automatically goes into sleep mode. ▶ **Reducing Power Consumption (Sleep Mode)(P. 89)**

\* Use of the default settings is recommended to achieve the most effective power savings.

1 to 60 (min.)

## [Auto Sleep Daily Timer]

[Menu] ▶ [Preferences] ▶ [Timer/Energy Settings]

Configure the machine to automatically enter sleep mode at a specified time. ▶ **Reducing Power Consumption (Sleep Mode)(P. 89)**

[Off]  
[On]  
(0:00 to 12:59 AM/PM)

## [Sleep Mode Exit Time Settings]

[Menu] ▶ [Preferences] ▶ [Timer/Energy Settings]

Configure the machine to automatically exit sleep mode at a specified time. ▶ **Reducing Power Consumption (Sleep Mode)(P. 89)**

[Off]

[On]

(0:00 to 12:59 AM/PM)

## [Network]

9664-06S

Specify the settings for the machine's network environment.

\* Values in bold red text are the default settings for each item.

- ▶ [Select Wired/Wireless LAN](P. 288)
- ▶ [Wireless LAN Settings](P. 288)
- ▶ [Direct Connection Settings](P. 288)
- ▶ [Easy Connection via PC](P. 289)
- ▶ [TCP/IP Settings](P. 289)
- ▶ [SNMP Settings](P. 289)
- ▶ [Dedicated Port Settings](P. 290)
- ▶ [Dedicated Port Authentication Method](P. 290)
- ▶ [Waiting Time for Connection at Startup] (P. 290)
- ▶ [Ethernet Driver Settings](P. 290)
- ▶ [IEEE 802.1X Settings](P. 291)
- ▶ [Firewall Settings](P. 291)
- ▶ [Device Settings Management On/Off](P. 292)
- ▶ [Monitoring Service](P. 292)
- ▶ [RMT-SW](P. 292)
- ▶ [Initialize Network Settings](P. 292)

### [Select Wired/Wireless LAN]

[Menu] ▶ [Preferences] ▶ [Network]

Set whether to connect the machine to the network using a wired or wireless LAN. ▶ **Selecting Wired or Wireless LAN(P. 45)**

\* If you are switching from a wired LAN to a wireless LAN, you can make the change within the procedure for configuring the wireless LAN.

<p>[Wired LAN]</p> <p>[Wireless LAN]</p>
--

### [Wireless LAN Settings]

[Menu] ▶ [Preferences] ▶ [Network]

Specify the settings for connecting the machine to a wireless LAN and to save energy while the machine is connected to a wireless LAN.

▶ **[Wireless LAN Settings](P. 293)**

### [Direct Connection Settings]

[Menu] ▶ [Preferences] ▶ [Network]

Specify the settings for using a direct connection and for the connection function. ▶ **Enabling the Direct Connection Function(P. 173)**

<p>[Use Direct Connection]</p> <p><b>[Off]</b></p> <p>[On]</p> <p>[Time Until Direct Connection Termination]</p> <p><b>0</b> (Off)</p> <p>1 to 60 (min.)</p> <p>[Access Point Mode Settings]</p>
--



[Use Custom SSID]
[Off]
[On]
[SSID (1-20 Characters)]
[Use Custom Network Key]
[Off]
[On]
[Network Key (10 Char.)]
[Keep Enabled If SSID/Ntwk Key Spcfd]* <sup>1</sup>
[Off]
[On]
[Config. IP Address For Direct Conn.]
<b>192.168.22.1</b>

\*<sup>1</sup> May not be displayed depending on the model, the installed options, and other settings.

## [Easy Connection via PC]

[Menu] ► [Preferences] ► [Network]

Start cableless setup mode.

To configure the network settings using the Canon Laser NW Device Setup Utility, select cableless setup mode.

\* You can download the Canon Laser NW Device Setup Utility from the Canon website for your country/region.  
<https://global.canon/en/support/>

## [TCP/IP Settings]

[Menu] ► [Preferences] ► [Network]

Specify the settings for using the machine on a TCP/IP network.

► [TCP/IP Settings](P. 295)

## [SNMP Settings]

[Menu] ► [Preferences] ► [Network]

Specify the settings for setting up, monitoring, and controlling the machine using SNMP management software. ►  
**Configuring SNMP(P. 69)**

To ensure compliance with the protocol's advanced specifications (RFC2790) when the machine's status is being monitored, set [Format Host Resources MIB to RFC2790] to [On].

[SNMPv1 Settings]
[Off]
[On]
[SNMPv3 Settings]
[Off]
[On]
[Acquire Printer Mngt. Info. from Host]

[Off]  
 [On]  
 [Format Host Resources MIB to RFC2790]  
 [Off]  
 [On]

## [Dedicated Port Settings]

[Menu] ► [Preferences] ► [Network]

Specify whether to use a dedicated port.

Use a dedicated port for tasks such as printing from a computer and configuring or browsing the machine's settings.

[Off]  
 [On]

## [Dedicated Port Authentication Method]

[Menu] ► [Preferences] ► [Network]

Set the authentication method when using a dedicated port.

If you specify [Mode 2], communication via the dedicated port will be limited to secure authentication methods only.

This may mean that you cannot connect to the machine from device management software, drivers or other software.

[Mode 1]  
 [Mode 2]

## [Waiting Time for Connection at Startup]

[Menu] ► [Preferences] ► [Network]

Set the waiting time until a connection is established when the machine starts up.

If the machine is connected via a device such as a switching hub, you may not be able to connect to the network even when the setting on the machine is correct. If so, set the waiting time and reconnect.

0 to 300 (sec.)

## [Ethernet Driver Settings]

[Menu] ► [Preferences] ► [Network]

Set the Ethernet communication method. [▶ Manually Configuring the Ethernet Settings\(P. 63\)](#)

This also allows you to check the MAC address on a wired LAN. [▶ Viewing the MAC Address of the Wired LAN\(P. 77\)](#)

\* If the [Communication Mode] is set to [Half Duplex], [1000BASE-T] cannot be selected.

[Auto Detect]  
 [Off]  
 [Communication Mode]  
 [Half Duplex]  
 [Full Duplex]  
 [Ethernet Type]

[10BASE-T]  
 [100BASE-TX]  
 [1000BASE-T]  
 [On]  
 [MAC Address]

## [IEEE 802.1X Settings]

[Menu] ► [Preferences] ► [Network]

Specify whether to use IEEE 802.1X.

Use Remote UI from a computer to set the IEEE 802.1X authentication method. ► **Using IEEE 802.1X(P. 215)**

\* [Use IEEE 802.1X] may not be displayed depending on the model, the installed options, and other settings.

[Off]  
 [On]

## [Firewall Settings]

[Menu] ► [Preferences] ► [Network]

Specify whether to enable an IP address filter and MAC address filter.

Use Remote UI from a computer to set the default policy for filtering and the exception addresses. ► **Setting the Firewall(P. 203)**

[IPv4 Address Filter]  
 [Outbound Filter]  
 [Off]  
 [On]  
 [Inbound Filter]  
 [Off]  
 [On]  
 [IPv6 Address Filter]  
 [Outbound Filter]  
 [Off]  
 [On]  
 [Inbound Filter]  
 [Off]  
 [On]  
 [MAC Address Filter]  
 [Outbound Filter]  
 [Off]  
 [On]  
 [Inbound Filter]  
 [Off]  
 [On]

## [Device Settings Management On/Off]

[Menu] ► [Preferences] ► [Network]

Select whether to use the device management software to manage the settings and other data in the machine. For more information, see the manual of the software you are using.

[Off]  
[On]

## [Monitoring Service]

[Menu] ► [Preferences] ► [Network]

Check that the machine can communicate with the monitoring server.  
Perform this operation to regularly send machine information to the monitoring server. For details, contact your dealer or service representative.

## [RMT-SW]

[Menu] ► [Preferences] ► [Network]

Normally, use the machine with this set to [Off].  
When your service representative carries out device maintenance remotely, he or she may change this to [On].

[Off]  
[On]

## [Initialize Network Settings]

[Menu] ► [Preferences] ► [Network]

Use this to restore the network settings to the factory settings. ► **Initializing Specific Settings and Data(P. 273)**

## [Wireless LAN Settings]

Specify the settings for connecting the machine to a wireless LAN and to save energy while the machine is connected to a wireless LAN.

\* Values in bold red text are the default settings for each item.

▶ [Select Network](P. 293)

▶ [Other Connections](P. 293)

▶ [Connection Settings](P. 294)

### [Select Network]

[Menu] ▶ [Preferences] ▶ [Network] ▶ [Wireless LAN Settings]

Select a wireless LAN router (access point) from the displayed list and enter the network key to connect. ▶ **Connecting to a Wireless LAN by Searching for a Router (Access Point Setup Method)(P. 53)**

### [Other Connections]

[Menu] ▶ [Preferences] ▶ [Network] ▶ [Wireless LAN Settings]

Connect to the wireless LAN by a method other than selecting the wireless LAN router from a list.

#### [Manually Enter Network Name]

[Menu] ▶ [Preferences] ▶ [Network] ▶ [Wireless LAN Settings] ▶ [Other Connections]

Connect to a wireless LAN router by manually entering all the router information, such as the SSID, network key and security settings. ▶ **Connecting to a Wireless LAN by Setting the Details (Manual Setup Method)(P. 55)**

[Security Settings]
[None]
[WEP]
<b>[Open System]</b>
Encryption keys 1 to 4
[Shared Key]
Encryption keys 1 to 4
<b>[WPA/WPA2-PSK]</b>
<b>[Auto]</b>
[AES-CCMP]
[WPA/WPA2-EAP]

#### [WPS Push Button Mode]

[Menu] ▶ [Preferences] ▶ [Network] ▶ [Wireless LAN Settings] ▶ [Other Connections]

Connect to a wireless LAN by pressing a button on a LAN router that supports WPS push button mode. ▶ **Connecting to a Wireless LAN by Using the Router Button (Push Button Mode)(P. 50)**

#### [WPS PIN Code Mode]

[Menu] ▶ [Preferences] ▶ [Network] ▶ [Wireless LAN Settings] ▶ [Other Connections]

Connect to a wireless LAN router that supports WPS PIN code mode by registering a PIN code generated by the machine. Use a computer or similar device to register the PIN code. **▶Connecting to a Wireless LAN by Entering a PIN Code (WPS PIN Code Mode)(P. 51)**

## [Connection Settings]

[Menu] ▶ [Preferences] ▶ [Network] ▶ [Wireless LAN Settings]

Configure the setting to save power when connecting by wireless LAN, and check the wireless LAN connection information.

### [Power Save Mode]

[Menu] ▶ [Preferences] ▶ [Network] ▶ [Wireless LAN Settings] ▶ [Connection Set.]

Specify whether to periodically set the machine to Power Save Mode according to signals sent from the wireless LAN router.

[Off]  
[On]

### [Connection Information]

[Menu] ▶ [Preferences] ▶ [Network] ▶ [Wireless LAN Settings] ▶ [Connection Set.]

Check data such as the security settings, as well as the wireless LAN MAC address and other connection information. **▶Viewing the MAC Address and Connection Information of the Wireless LAN(P. 78)**

[MAC Address]  
[Wireless LAN Status]  
[Latest Error Information]  
[Channel]  
[Network Name]  
[Security Settings]  
[Power Save Mode]

## [TCP/IP Settings]

Specify the settings to use the machine on a TCP/IP network.

\* Values in bold red text are the default settings for each item.

- ▶ [IPv4 Settings](P. 295)
- ▶ [IPv6 Settings](P. 297)
- ▶ [WINS Settings](P. 298)
- ▶ [LPD Settings](P. 299)
- ▶ [RAW Settings](P. 299)
- ▶ [WSD Settings](P. 299)
- ▶ [IPP Print Settings](P. 300)
- ▶ [Use HTTP](P. 300)
- ▶ [Use IPsec](P. 300)
- ▶ [Port Number Settings](P. 300)
- ▶ [MTU Size](P. 301)

### [IPv4 Settings]

[Menu] ▶ [Preferences] ▶ [Network] ▶ [TCP/IP Settings]

Specify the settings to use the machine in an IPv4 environment.

#### [IP Address Settings]

[Menu] ▶ [Preferences] ▶ [Network] ▶ [TCP/IP Settings] ▶ [IPv4 Settings]

Set the IPv4 address either automatically or manually. ▶ **Setting IPv4 Addresses(P. 58)**

**[Auto Acquire]**  
 [Select Protocol]  
 [Off]  
**[DHCP]**  
 [Auto IP]  
 [Off]  
**[On]**

[Manually Acquire]\*1  
 [IP Address]: 0.0.0.0  
 [Subnet Mask]: 0.0.0.0  
 [Gateway Address]: 0.0.0.0

[Check Settings]

\*1 May not be displayed depending on the model, the installed options, and other settings.

#### [PING Command]

[Menu] ▶ [Preferences] ▶ [Network] ▶ [TCP/IP Settings] ▶ [IPv4 Settings]

Execute a PING command to check whether the machine can connect to devices on the network. ▶ **Checking Whether the Machine Can Connect to Network Devices(P. 76)**

#### [DNS Settings]

[Menu] ▶ [Preferences] ▶ [Network] ▶ [TCP/IP Settings] ▶ [IPv4 Settings]

Specify the DNS settings when using the machine in an environment with a Domain Name System (DNS) implemented. ▶ **Configuring DNS(P. 64)**

[DNS Server Settings]  
 [Primary DNS Server]: 0.0.0.0  
 [Secondary DNS Server]: 0.0.0.0

[DNS Host Name/Domain Name Settings]  
 [Host Name]  
 [Domain Name]

[DNS Dynamic Update Settings]  
**[Off]**  
 [On]  
 [DNS Dyn. Updt. Intrvl.]  
 0 to **24** to 48 (hr.)

### [mDNS Settings]

---

[Menu] ► [Preferences] ► [Network] ► [TCP/IP Settings] ► [IPv4 Settings]

Specify the mDNS settings to use DNS functions in an environment such as Bonjour with no DNS installed.

[Off]  
**[On]**  
 [mDNS Name]

### [DHCP Option Settings]

---

[Menu] ► [Preferences] ► [Network] ► [TCP/IP Settings] ► [IPv4 Settings]

Specify the settings for using a DHCP server in an IPv4 environment with a Domain Name System (DNS) implemented. ► **Configuring DNS(P. 64)**

[Acquire Host Name]  
 [Off]  
**[On]**

[DNS Dynamic Update]  
**[Off]**  
 [On]

[Acquire DNS Server Address]  
 [Off]  
**[On]**

[Acquire Domain Name]  
 [Off]  
**[On]**

[Acquire WINS Server Address]  
 [Off]  
**[On]**

[Acquire POP Server Address]  
**[Off]**



[On]

## [IPv6 Settings]

[Menu] ▶ [Preferences] ▶ [Network] ▶ [TCP/IP Settings]

Specify the settings for using the machine in an IPv6 environment.

You can set multiple IPv6 addresses and use them at the same time. [▶Setting IPv6 Addresses\(P. 60\)](#)

### [Use IPv6]

[Menu] ▶ [Preferences] ▶ [Network] ▶ [TCP/IP Settings] ▶ [IPv6 Settings]

Configure whether to use IPv6.

[Off]

[On]

[Check Settings]

### [Stateless Address Settings]

[Menu] ▶ [Preferences] ▶ [Network] ▶ [TCP/IP Settings] ▶ [IPv6 Settings]

Configure whether to use a stateless address.

[Off]

[On]

[Check Settings]

### [Use DHCPv6]

[Menu] ▶ [Preferences] ▶ [Network] ▶ [TCP/IP Settings] ▶ [IPv6 Settings]

Configure whether to use a stateful address obtained from a DHCP server using DHCPv6.

[Off]

[On]

[Check Settings]

### [DNS Settings]

[Menu] ▶ [Preferences] ▶ [Network] ▶ [TCP/IP Settings] ▶ [IPv6 Settings]

Specify the DNS settings when using the machine in an environment with a Domain Name System (DNS) implemented. [▶Configuring DNS\(P. 64\)](#)

[DNS Host Name/Domain Name Settings]

[Use IPv4 Host/Domain]

[Off]

[Host Name]

[Domain Name]

[On]

[DNS Dynamic Update Settings]

[Off]

[On]

[Regist. Manual Addr.]

[Off]

[On]  
 [Regist. Stateful Addr.]  
 [Off]  
 [On]  
 [Regist Stateless Addr.]  
 [Off]  
 [On]  
 [DNS Dynamic Update Interval]  
 0 to **24** to 48 (hr.)

### [mDNS Settings]

[Menu] ▶ [Preferences] ▶ [Network] ▶ [TCP/IP Settings] ▶ [IPv6 Settings]

Specify the mDNS settings to use DNS functions in an environment such as Bonjour with no DNS installed.

[Off]  
 [On]  
 [Use IPv4 Name for mDNS]  
 [Off]  
 [mDNS Name]  
 [On]

### [DHCP Option Settings]

[Menu] ▶ [Preferences] ▶ [Network] ▶ [TCP/IP Settings] ▶ [IPv6 Settings]

Specify the settings for using a DHCP server in an IPv4 environment with a Domain Name System (DNS) implemented. **Configuring DNS(P. 64)**

[Acquire DNS Server Address]  
 [Off]  
 [On]  
 [Acquire Domain Name]  
 [Off]  
 [On]

## [WINS Settings]

[Menu] ▶ [Preferences] ▶ [Network] ▶ [TCP/IP Settings]

Configure WINS (Windows Internet Name Service) when using the machine in a network environment that uses both NetBIOS and TCP/IP. **Configuring WINS(P. 68)**

[WINS Resolution]  
 [Off]  
 [On]  
 [WINS Server Address]: 0.0.0.0

## [LPD Settings]

[Menu] ▶ [Preferences] ▶ [Network] ▶ [TCP/IP Settings]

Specify whether to use the LPD protocol. **▶Configuring LPD, RAW, or WSD(P. 242)**

If the LPD protocol is used, you can also set the time from the start of reception standby, after print data reception is canceled, to the timeout.

[LPD Print Settings] [Off] <b>[On]</b>
[RX Timeout] 1 to <b>5</b> to 60 (min.)

## [RAW Settings]

[Menu] ▶ [Preferences] ▶ [Network] ▶ [TCP/IP Settings]

Specify whether to use the RAW protocol. **▶Configuring LPD, RAW, or WSD(P. 242)**

If the RAW protocol is used, you can also set the time from the start of reception standby, after print data reception is canceled, to the timeout.

[RAW Print Settings] [Off] <b>[On]</b>
[RX Timeout] 1 to <b>5</b> to 60 (min.)

## [WSD Settings]

[Menu] ▶ [Preferences] ▶ [Network] ▶ [TCP/IP Settings]

Specify whether to use the WSD protocol. You can specify this setting for each of the functions that use the WSD protocol. **▶Configuring LPD, RAW, or WSD(P. 242)**

[WSD Print Settings] [Use WSD Print] [Off] <b>[On]</b>
[Use WSD Browsing] [Off] <b>[On]</b>
[Use Multicast Discovery] [Off] <b>[On]</b>

## [IPP Print Settings]

[Menu] ▶ [Preferences] ▶ [Network] ▶ [TCP/IP Settings]

Specify whether to use IPP (Internet Printing Protocol). You can use IPP when printing with AirPrint. **▶Setting the Functions and Security to Be Used with AirPrint(P. 176)**

When using IPP, you can also specify whether TLS encryption is used for communication.

[Use IPP Printing] [Off] <b>[On]</b>
[Allow IPP Printing Only When Using TLS] <b>[Off]</b> [On]

## [Use HTTP]

[Menu] ▶ [Preferences] ▶ [Network] ▶ [TCP/IP Settings]

Specify whether to use HTTP. **▶Disabling HTTP Communication(P. 244)**

[Off] <b>[On]</b>
----------------------

## [Use IPsec]

[Menu] ▶ [Preferences] ▶ [Network] ▶ [TCP/IP Settings]

Specify whether to use IPsec (IP Security Protocol).

Use Remote UI from a computer to specify setting such as the IPsec policy, selector, and IKE. **▶Using IPsec(P. 211)**

<b>[Off]</b> [On]
----------------------

## [Port Number Settings]

[Menu] ▶ [Preferences] ▶ [Network] ▶ [TCP/IP Settings]

Specify the port number for the protocol used in accordance with the port numbers for the computer, server or other device. **▶Changing the Port Number(P. 206)**

[LPD] 1 to <b>515</b> to 65535
[RAW] 1 to <b>9100</b> to 65535
[WSD Multicast Discovery] 1 to <b>3702</b> to 65535
[HTTP]

1 to <b>80</b> to 65535
[Multicast Discovery] 1 to <b>427</b> to 65535
[POP3] 1 to <b>110</b> to 65535
[SNMP] 1 to <b>161</b> to 65535

## [MTU Size]

[Menu] ▶ [Preferences] ▶ [Network] ▶ [TCP/IP Settings]

If communication slows down due to the size of the packets sent, use this to change the maximum size for outgoing packets.

[1300]
[1400]
[ <b>1500</b> ]

## [External Interface]

---

9664-06X

Specify the settings for USB connections.

\* Values in bold red text are the default settings for each item.

### ▶ [USB Settings](P. 302)

#### [USB Settings]

[Menu] ▶ [Preferences] ▶ [External Interface]

Specify the settings for using the USB ports and USB memory devices.

- Specify whether to use the USB port for connecting to the computer in [Use as USB Device]. ▶ **Preventing Connection to Computer via USB Port(P. 241)**
- Specify whether to use memory media such as USB memory devices in [Use USB Storage Device]. ▶ **Restricting Use of Memory Media(P. 234)**

[Use as USB Device]

[Off]

**[On]**

[Use USB Storage Device]

[Off]

**[On]**

## [Accessibility]

Configure control panel screen features such as screen color inversion and message display time to make the screen easier to see.

\* Values in bold red text are the default settings for each item.

- ▶ [Invert Screen Colors](P. 303)
- ▶ [Brightness](P. 303)
- ▶ [Contrast](P. 303)
- ▶ [Message Display Time](P. 303)
- ▶ [Scrolling Speed](P. 304)
- ▶ [Cursor Movement Type](P. 304)

### [Invert Screen Colors]

[Menu] ▶ [Preferences] ▶ [Accessibility]

Specify whether light and dark on the control panel screen are reversed.

Use this setting when the display is still difficult to see even after you have adjusted the brightness. ▶ [Brightness] (P. 303)

[Off]  
[On]

### [Brightness]

[Menu] ▶ [Preferences] ▶ [Accessibility]

Adjust the brightness of the control panel screen when it is difficult to see.

5 levels

### [Contrast]

[Menu] ▶ [Preferences] ▶ [Accessibility]

Adjust the contrast to make the control panel screen easier to view.

7 levels

### [Message Display Time]

[Menu] ▶ [Preferences] ▶ [Accessibility]

Set the number of seconds for which each message is displayed when 2 messages are displayed alternately on the control panel screen.

1 to **2** to 5 (sec.)

## [Scrolling Speed]

[Menu] ► [Preferences] ► [Accessibility]

Set the scrolling speed when operating the screen.

[Slow]
<b>[Standard]</b>
[Fast]

## [Cursor Movement Type]

[Menu] ► [Preferences] ► [Accessibility]

Set the cursor operation when entering text.

Set to [Auto] to move the cursor automatically to the next input field after entering text. When set to [Manual], you must press  to move the cursor.

<b>[Auto]</b>
[Manual]



## [Volume Settings]

Set whether the machine emits sounds notifying you of operations and statuses. ▶ **Adjusting the Volume(P. 132)**

- ▶ [Entry Tone](P. 305)
- ▶ [Invalid Entry Tone](P. 305)
- ▶ [Restock Supplies Tone](P. 305)
- ▶ [Warning Tone](P. 305)
- ▶ [Job Done Tone](P. 306)
- ▶ [Energy Saver Alert](P. 306)

### [Entry Tone]

[Menu] ▶ [Preferences] ▶ [Volume Settings]

Set whether to emit a sound when you press the keys and buttons on the control panel.

[Off]  
[On]

### [Invalid Entry Tone]

[Menu] ▶ [Preferences] ▶ [Volume Settings]

Set whether to emit a sound when an invalid key is pressed, such as when you enter a value outside the setting range.

[Off]  
[On]

### [Restock Supplies Tone]

[Menu] ▶ [Preferences] ▶ [Volume Settings]

Set whether to emit a sound when the toner cartridge is nearing the end of its lifetime.

[Off]  
[On]

### [Warning Tone]

[Menu] ▶ [Preferences] ▶ [Volume Settings]

Set whether to emit a sound when the machine has a paper jam or other malfunction.

[Off]  
[On]

## [Job Done Tone]

[Menu] ▶ [Preferences] ▶ [Volume Settings]

Set whether to emit a sound when the print operation on the machine is completed.

[Off]  
[On]

## [Energy Saver Alert]

[Menu] ▶ [Preferences] ▶ [Volume Settings]

Set whether to emit a sound when the machine enters and exits sleep mode.

[Off]  
[On]

## [Adjustment/Maintenance]

---

9664-071

Use this setting to adjust the print quality and when cleaning the machine.

▶[Adjust Image Quality](P. 307)

▶[Maintenance](P. 307)

### [Adjust Image Quality]

[Menu] ▶ [Adjustment/Maintenance]

Use this setting to adjust the image quality or print position and for special processing according to the paper used.

▶[Adjust Image Quality](P. 308)

### [Maintenance]

[Menu] ▶ [Adjustment/Maintenance]

Carry out maintenance to clean the machine and to control condensation.

▶[Maintenance](P. 315)

## [Adjust Image Quality]

9664-072

Use this setting to adjust the image quality or print position and for special processing according to the paper used.

\* Values in bold red text are the default settings for each item.

▶ [Printer Density](P. 308)

▶ [Toner Save](P. 308)

▶ [Adjust Print Position](P. 308)

▶ [Special Processing](P. 309)

### [Printer Density]

[Menu] ▶ [Adjustment/Maintenance] ▶ [Adjust Image Quality]

If printed text or fine lines appear faded, adjust the density. ▶ **Adjusting the Print Density(P. 381)**

9 levels

### [Toner Save]

[Menu] ▶ [Adjustment/Maintenance] ▶ [Adjust Image Quality]

Specify whether to adjust the print quality to save toner.

To give priority to print quality, select [Off].

[Off]

[On]

### [Adjust Print Position]

[Menu] ▶ [Adjustment/Maintenance] ▶ [Adjust Image Quality]

Adjust the print position if text or images are printed off-center or outside the printable range. ▶ **Adjusting the Print Position(P. 382)**

[Multi-Purpose Tray]

[Adjust Vertically (Front Side)]

-5.0 to **0.0** to +5.0 (mm)

[Adjust Horizontally (Front Side)]

-5.0 to **0.0** to +5.0 (mm)

[Adjust Vertically (Back Side)]

-5.0 to **0.0** to +5.0 (mm)

[Adjust Horizontally (Back Side)]

-5.0 to **0.0** to +5.0 (mm)

[Drawer 1]

[Adjust Vertically (Front Side)]

-5.0 to **0.0** to +5.0 (mm)

[Adjust Horizontally (Front Side)]

-5.0 to **0.0** to +5.0 (mm)

[Adjust Vertically (Back Side)] -5.0 to <b>0.0</b> to +5.0 (mm)
[Adjust Horizontally (Back Side)] -5.0 to <b>0.0</b> to +5.0 (mm)
[Drawer 2]* <sup>1</sup>
[Adjust Vertically (Front Side)] -5.0 to <b>0.0</b> to +5.0 (mm)
[Adjust Horizontally (Front Side)] -5.0 to <b>0.0</b> to +5.0 (mm)
[Adjust Vertically (Back Side)] -5.0 to <b>0.0</b> to +5.0 (mm)
[Adjust Horizontally (Back Side)] -5.0 to <b>0.0</b> to +5.0 (mm)

\*<sup>1</sup> May not be displayed depending on the model, the installed options, and other settings.

## [Special Processing]

[Menu] ▶ [Adjustment/Maintenance] ▶ [Adjust Image Quality]

Use a range of processes to resolve problems that arise due to factors such as the paper type, the material used, or its condition.

🔍 **[Special Processing](P. 310)**

## [Special Processing]

9664-074

Use a range of processes to resolve problems that arise due to factors such as the paper type, the material used, or its condition.

\* Values in bold red text are the default settings for each item.

- ▶ [Special Paper Processing](P. 310)
- ▶ [Reduce Ppr. Sticking at Output](P. 312)
- ▶ [High Humidity Mode](P. 312)
- ▶ [Low Humidity Mode](P. 312)
- ▶ [Reduce Ghosting 1](P. 312)
- ▶ [Reduce Condensation (Consec. 2-Sd Print)](P. 313)
- ▶ [Rdc. Wrinkles(Humidity)/Streaks](P. 313)
- ▶ [Quiet Mode](P. 313)
- ▶ [Correct Blurry Image](P. 313)
- ▶ [Rdc Blk Space Dark. After Rplc Cart.](P. 314)

### [Special Paper Processing]

[Menu] ▶ [Adjustment/Maintenance] ▶ [Adjust Image Quality] ▶ [Special Processing]

Specify special processing for the paper in the following situations:

- If you are using the back of printed paper
- If you are printing on envelopes with a rough surface
- If the paper curls during printing
- If the paper creases or wrinkles when printed

#### [Manual Back Side Print (2-Sided Only)]

[Menu] ▶ [Adjustment/Maintenance] ▶ [Adjust Image Quality] ▶ [Special Processing] ▶ [Special Paper Processing]

If you are using paper that has already been printed on, images or text may be blurred. If so, specifying [On] for that paper source may improve the print results.

\* When this is set to [On], if some time has passed since the front side of the paper was printed, or depending on the operating environment humidity, changes in image quality may occur.

[Multi-Purpose Tray]
[Off]
[On]
[Drawer 1]
[Off]
[On]
[Drawer 2]* <sup>1</sup>
[Off]
[On]

\*<sup>1</sup> May not be displayed depending on the model, the installed options, and other settings.

**[Rough Surface Envelope Mode]**

---

[Menu] ▶ [Adjustment/Maintenance] ▶ [Adjust Image Quality] ▶ [Special Processing] ▶ [Special Paper Processing]

Specify [On] if you are printing on envelopes with a rough surface.

\* This setting is only available when the paper type is set to [Envelope 2].

\* Specifying [On] decreases the printing speed.

\* Specifying [On] disables the [Paper Curl Correction] setting.

[Off]  
[On]

**[Paper Wrinkle Correction]**

---

[Menu] ▶ [Adjustment/Maintenance] ▶ [Adjust Image Quality] ▶ [Special Processing] ▶ [Special Paper Processing]

Depending on the paper used, printing may cause paper wrinkling. In this event, specifying [On] may correct the paper wrinkling.

\* Specifying [On] may cause faded printing or make printing slower.

[Off]  
[On]

**[Paper Curl Correction]**

---

[Menu] ▶ [Adjustment/Maintenance] ▶ [Adjust Image Quality] ▶ [Special Processing] ▶ [Special Paper Processing]

Depending on paper used, the paper may curl during printing. If so, specifying [On] in this setting may alleviate paper curling.

\* Specifying [On] in this setting may lead to faded print or make printing slower.

[Off]  
[On]

**[Rdc. Tnr Flaking from Heavy Sml. Ppr]**

---

[Menu] ▶ [Adjustment/Maintenance] ▶ [Adjust Image Quality] ▶ [Special Processing] ▶ [Special Paper Processing]

Printing photos or other halftone images on small-sized heavy paper may result in streaked stains on the back of the paper. If this occurs, specifying [On] may improve the print results.

\* Specifying [On] may make printing slower.

[Off]  
[On]

**[Reduce Thin Paper Curling]**

---

[Menu] ▶ [Adjustment/Maintenance] ▶ [Adjust Image Quality] ▶ [Special Processing] ▶ [Special Paper Processing]

The paper may curl when you print on thin paper. If this occurs, specifying [On] may correct the paper curling.

- \* This setting is only available when the paper type is set to [Thin].
- \* If you specify [On], you will no longer be able to use automatic 2-sided printing with the [Thin] setting.
- \* Specifying [On] may cause the toner not to adhere fully to the paper, resulting in faded printing.

[Off]  
[On]

## [Reduce Ppr. Sticking at Output]

[Menu] ▶ [Adjustment/Maintenance] ▶ [Adjust Image Quality] ▶ [Special Processing]

In 2-sided printing involving multiple pages, printed paper sheets may stick together. If so, specifying [On] in this setting may reduce the likelihood of paper sheets sticking together.

- \* Specifying [On] in this setting slows down the print speed.

[Off]  
[On]

## [High Humidity Mode]

[Menu] ▶ [Adjustment/Maintenance] ▶ [Adjust Image Quality] ▶ [Special Processing]

Printing in a high-humidity environment may cause uneven print density. If so, specifying [On] may improve the print results.

- \* Specifying [On] may create variations in the print density in environments with low humidity.

[Off]  
[On]

## [Low Humidity Mode]

[Menu] ▶ [Adjustment/Maintenance] ▶ [Adjust Image Quality] ▶ [Special Processing]

Printing in a low-humidity environment may lead to blurred images and/or text. If so, specifying [Mode 1] may correct the problem. If this does not correct the problem, select [Mode 2]

- \* Enabling this setting may lead to faint or uneven printing in high-humidity environments.

[Off]  
[Mode 1]  
[Mode 2]

## [Reduce Ghosting 1]

[Menu] ▶ [Adjustment/Maintenance] ▶ [Adjust Image Quality] ▶ [Special Processing]

If you print on small-sized paper and then continue printing on a larger sized paper, ghost images may appear in the unprinted sections of the paper. If this occurs, specifying [On] may improve the print results.

- \* When you select [On], the printing speed may decrease.



[Off]  
[On]

## [Reduce Condensation (Consec. 2-Sd Print)]

[Menu] ▶ [Adjustment/Maintenance] ▶ [Adjust Image Quality] ▶ [Special Processing]

In 2-sided printing, water droplets inside the machine may result in images being printed faintly. If so, specifying [On] in this setting may reduce the amount of condensation inside the machine.

\* Specifying [On] in this setting makes printing slower.

[Off]  
[On]

## [Rdc. Wrinkles(Humidity)/Streaks]

[Menu] ▶ [Adjustment/Maintenance] ▶ [Adjust Image Quality] ▶ [Special Processing]

Printing on damp paper may make the paper wrinkle or printing may lead to streaks at the edges of the paper when printing halftone images such as photos. If this occurs, specifying [On] may improve the print results.

\* When you select [On], the printing speed will decrease.

[Off]  
[On]

## [Quiet Mode]

[Menu] ▶ [Adjustment/Maintenance] ▶ [Adjust Image Quality] ▶ [Special Processing]

If the operation sound during printing is loud, selecting [On] may reduce the operation sound.

\* When you select [On], the printing speed will decrease.

[Off]  
[On]

## [Correct Blurry Image]

[Menu] ▶ [Adjustment/Maintenance] ▶ [Adjust Image Quality] ▶ [Special Processing]

Depending on the paper type and operating environment, smudges may appear on the printed paper. If this occurs, selecting [Mode 1] may improve the print results. If that does not work, try selecting [Mode 2], [Mode 3] and then [Mode 4] in that order.

\* Enabling this setting may reduce the print density or slow down printing. It may also make outlines less distinct or make them slightly rougher.

[Off]  
[Mode 1]  
[Mode 2]  
[Mode 3]  
[Mode 4]

## [Rdc Blnk Space Dark. After Rplc Cart.]

[Menu] ▶ [Adjustment/Maintenance] ▶ [Adjust Image Quality] ▶ [Special Processing]

Black streaks may appear immediately after replacing a toner cartridge, and printing may generally be darker when printing on heavy paper. If this occurs, specifying [On] may improve the print results. This setting is enabled the next time you replace a toner cartridge.

\* If you specify [On], it will take some time for the toner to be evenly distributed immediately after toner cartridge replacement.

[Off]
[On]

## [Maintenance]

9664-075

Carry out maintenance to clean the machine and control condensation.

\* Values in bold red text are the default settings for each item.

▶ [Clean Fixing Assembly](P. 315)

▶ [Control Condensation](P. 315)

### [Clean Fixing Assembly]

[Menu] ▶ [Adjustment/Maintenance] ▶ [Maintenance]

Perform this operation to clean the fixing assembly if black streaks appear on printed paper following procedures such as toner cartridge replacement. ▶ **Cleaning the Fixing Assembly(P. 370)**

### [Control Condensation]

[Menu] ▶ [Adjustment/Maintenance] ▶ [Maintenance]

In environments subject to sudden temperature changes, condensation may form and cause images and/or text to be faint or blurred. If so, specifying [On] may improve the print results.

During condensation removal, a blank sheet of paper may be output without printing correctly. If you set this to [On], you can set whether to restrict printing.

\* If you set this to [On], you must keep the machine ON to continuously remove the condensation. The Auto Shutdown Time setting is disabled.

[Off]

[On]

[**Allow Job Printing During Process**]

[Do Not Allow Job Printing During Process]

## [Function Settings]

Specify the settings for printing and receiving I-Faxes.

\* Values in bold red text are the default settings for each item.

- ▶ [Common](P. 316)
- ▶ [Printer](P. 316)
- ▶ [Receive](P. 316)
- ▶ [Secure Print](P. 316)

### [Common]

[Menu] ▶ [Function Settings]

Specify the settings for function operation, such as the paper source and printing.

- ▶ [Common](P. 318)

### [Printer]

[Menu] ▶ [Function Settings]

Specify the printer settings.

- ▶ [Printer](P. 322)

### [Receive]

[Menu] ▶ [Function Settings]

Specify the settings for I-Faxes.

- ▶ [Receive](P. 340)

### [Secure Print]

[Menu] ▶ [Function Settings]

Specify whether to use the Secure Print function, which assigns a PIN for printing. ▶ **Printing a Document Secured with a PIN (Secure Print)(P. 159)**

- To restrict printing from a computer to Secure Print jobs only, specify [Restrict Printer Jobs] also. ▶ **Restricting Printing from a Computer to Secure Print(P. 237)**
- To change the period of time until the print data that was sent with a PIN (secure data) and is temporarily saved in the memory of the machine is deleted, specify the [Secure Print Deletion Time] setting also. ▶ **Changing the Time Period That Print Data with a PIN (Secure Data) Is Saved(P. 162)**

[Use Secure Print]

[Off]

[On]

[Restrict Printer Jobs]

[Off]

[On]

[Secure Print Deletion Time]  
10 to **30** to 240 (min.)

## [Common]

---

9664-077

Specify the settings for function operations, such as the paper source and printing.

▶ **[Paper Feed Settings](P. 318)**

▶ **[Print Settings](P. 318)**

### [Paper Feed Settings]

[Menu] ▶ [Function Settings] ▶ [Common]

Specify the settings for the paper source.

▶ **[Paper Feed Settings](P. 319)**

### [Print Settings]

[Menu] ▶ [Function Settings] ▶ [Common]

Specify the settings for printing.

▶ **[Print Settings](P. 321)**

## [Paper Feed Settings]

9664-078

Specify the settings for the paper source.

\* Values in bold red text are the default settings for each item.

▶ [Drawer Auto Selection On/Off](P. 319)

▶ [Switch Paper Feed Method](P. 320)

### [Drawer Auto Selection On/Off]

[Menu] ▶ [Function Settings] ▶ [Common] ▶ [Paper Feed Settings]

Specify the settings for each function so that the machine automatically selects the correct paper source for the size of the paper to be printed. ▶ **Using the Appropriate Paper Source for Each Function(P. 128)**

[Printer]
[Multi-Purpose Tray]
[Off]
<b>[On]</b>
[Drawer 1]
[Off]
<b>[On]</b>
[Drawer 2] <sup>*1</sup>
[Off]
<b>[On]</b>
[Receive]
[Multi-Purpose Tray]
<b>[Off]</b>
[On]
[Drawer 1]
[Off]
<b>[On]</b>
[Drawer 2] <sup>*1</sup>
[Off]
<b>[On]</b>
[Other]
[Multi-Purpose Tray]
<b>[Off]</b>
[On]
[Drawer 1]
[Off]
<b>[On]</b>
[Drawer 2] <sup>*1</sup>
[Off]
<b>[On]</b>

\*1 May not be displayed depending on the model, the installed options, and other settings.

## [Switch Paper Feed Method]

[Menu] ▶ [Function Settings] ▶ [Common] ▶ [Paper Feed Settings]

When printing on paper with a logo, specify the paper loading method for each paper source. When this type of paper is used, the default setting is that the paper is loaded differently depending on whether printing is 1-sided or 2-sided. For the paper source for which [Print Side Priority] is set, always load the paper for 2-sided printing, regardless of whether printing is 1-sided or 2-sided. **Orientation for Loading Paper with a Logo(P. 115)**

\* If you specify [Print Side Priority] in this setting, 1-sided printing will be slower. If you are using paper without a pre-printed logo, or if you are not using 2-sided printing for paper with a pre-printed logo, specify [Speed Priority].

[Multi-Purpose Tray] [Speed Priority] [Print Side Priority]
[Drawer 1] [Speed Priority] [Print Side Priority]
[Drawer 2]*1 [Speed Priority] [Print Side Priority]

\*1 May not be displayed depending on the model, the installed options, and other settings.

## NOTE

- If you specify [Print Side Priority] for a paper source containing a paper that cannot be used for 2-sided printing, that setting is disabled and the machine operates using the [Speed Priority] setting.



## [Print Settings]

---

9664-079

Specify the settings for printing.

\* Values in bold red text are the default settings for each item.

### ▶ [Auto Delete Suspended Jobs](P. 321)

#### [Auto Delete Suspended Jobs]

[Menu] ▶ [Function Settings] ▶ [Common] ▶ [Print Settings]

Specify whether to automatically delete the print job when an error occurs and printing stops.  
If you specify automatic deletion, you can also specify the time before the job is deleted.

[Off]

[On]

0 to **5** to 240 (min.)

## [Printer]

---

9664-07A

Specify the printer settings.

▶ **[Printer Settings](P. 322)**

▶ **[PDL Selection (Plug and Play)](P. 322)**

### [Printer Settings]

[Menu] ▶ [Function Settings] ▶ [Printer]

Specify the settings for printer operation and for processing print data.

▶ **[Printer Settings](P. 323)**

### [PDL Selection (Plug and Play)]

[Menu] ▶ [Function Settings] ▶ [Printer]

Specify which Page Description Language (PDL) to use when connecting the machine to a computer using Plug and Play.

▶ **[PDL Selection (Plug and Play)](P. 339)**

## [Printer Settings]

9664-07C

Specify the settings for printer operation and for processing print data.

\* Values in bold red text are the default settings for each item.

- ▶ [Action When Free Paper Size Mismatch](P. 323)
- ▶ [Copies](P. 323)
- ▶ [2-Sided Printing](P. 324)
- ▶ [Default Paper](P. 324)
- ▶ [Paper Size Override](P. 324)
- ▶ [Print Quality](P. 324)
- ▶ [Layout](P. 325)
- ▶ [Auto Error Skip](P. 327)
- ▶ [Timeout](P. 327)
- ▶ [Personality](P. 327)
- ▶ [Escape Tray Mode](P. 327)
- ▶ [Speed/Print Side Priority for 2-Sided](P. 327)
- ▶ [Prioritize Multi-Purpose Tray](P. 328)
- ▶ [Check Paper Size in Tray](P. 328)
- ▶ [Recovery Printing](P. 328)
- ▶ [UFR II](P. 328)
- ▶ [PCL](P. 329)
- ▶ [PS](P. 333)
- ▶ [Imaging Settings](P. 334)
- ▶ [PDF](P. 335)
- ▶ [XPS](P. 336)

### NOTE

#### If the Control Panel and Printer Driver Have the Same Settings

- Priority is given to the printer driver settings. The control panel settings are valid for operating systems such as UNIX, PS, and PCL printing where printer drivers cannot be used and when printing from mobile devices.

### [Action When Free Paper Size Mismatch]

[Menu] ▶ [Function Settings] ▶ [Printer] ▶ [Printer Settings]

When the paper size of each paper source is set to [Free Size] in [Paper Settings], you can specify the operation that is to be performed when the size of the loaded paper is significantly different from the setting in the printer driver.

If the printer driver's settings do not match the size and type of loaded paper, a paper jam or printing error may occur.

[Multi-Purpose Tray]
[Force Output]
[Display Error]
[Drawer 1]
[Force Output]
[Display Error]
[Drawer 2]*1
[Force Output]
[Display Error]

\*1 May not be displayed depending on the model, the installed options, and other settings.

### [Copies]

[Menu] ▶ [Function Settings] ▶ [Printer] ▶ [Printer Settings]

Specify the number of copies to be printed.

1 to 999

## [2-Sided Printing]

[Menu] ▶ [Function Settings] ▶ [Printer] ▶ [Printer Settings]

Specify whether to print on both sides of the paper.

[Off]  
[On]

## [Default Paper]

[Menu] ▶ [Function Settings] ▶ [Printer] ▶ [Printer Settings]

Specify the paper size and type to be used when printing from a mobile device or an OS that does not support the printer driver.

See below for the papers that can be specified.

🔴 Usable Paper(P. 18)

## [Paper Size Override]

[Menu] ▶ [Function Settings] ▶ [Printer] ▶ [Printer Settings]

Specify whether the machine substitutes A4 size paper for Letter size paper and vice-versa when printing. Specifying [On] in this setting means that if, for example, printing on A4 size paper is specified on the computer and there is only Letter size paper loaded, the job is printed on Letter size paper instead.

\* Print settings are specified in an application or printer driver, but this setting can only be specified on the control panel.

[Off]  
[On]

## [Print Quality]

[Menu] ▶ [Function Settings] ▶ [Printer] ▶ [Printer Settings]

Adjust print quality settings such as the density and resolution according to the document being printed and the purpose.

### [Density]

[Menu] ▶ [Function Settings] ▶ [Printer] ▶ [Printer Settings] ▶ [Print Quality]

Adjust the toner density used when printing.  
For more precise adjustment, you can adjust the levels of the three density areas in [Fine Adjust].

\* Note that you cannot adjust the toner density if [Toner Save] is set to [On]. 🔴 [Toner Save](P. 325)

\* [Density] may not be displayed depending on the model, the installed options, and other settings.

[Density]  
17 levels

[Density (Fine Adjust)] [High]/[Medium]/[Low] 17 levels
---

### [Toner Save]

[Menu] ▶ [Function Settings] ▶ [Printer] ▶ [Printer Settings] ▶ [Print Quality]

Specify whether to save toner when printing.

Specify [On] in this setting when you only want to check the layout or other finishing prior to the final print, such as before printing a very large job.

[Off] [On]
---------------

### [Image Refinement]

[Menu] ▶ [Function Settings] ▶ [Printer] ▶ [Printer Settings] ▶ [Print Quality]

Specify whether to use smoothing processing that will produce smoother printed outlines in text and figures.

[Off] [On]
---------------

### [Resolution]

[Menu] ▶ [Function Settings] ▶ [Printer] ▶ [Printer Settings] ▶ [Print Quality]

Specify the resolution used to process print data.

To print with a higher resolution, specify [1200 dpi] in this setting.

[1200 dpi] [600 dpi]
-------------------------

## [Layout]

[Menu] ▶ [Function Settings] ▶ [Printer] ▶ [Printer Settings]

Specify the gutter direction or margin and the print position.

### [Binding Location]

[Menu] ▶ [Function Settings] ▶ [Printer] ▶ [Printer Settings] ▶ [Layout]

Specify whether the gutter will be on the long edge or the short edge when the printed document will be bound using a method such as staples.

Use this setting in conjunction with the [Gutter] setting to adjust the binding position and margins. ▶ **[Gutter]** (P. 326)

- To bind the paper on the long edge, specify [Long Edge] in this setting.



- To bind the paper on the short edge, specify [Short Edge] in this setting.



[Long Edge]  
[Short Edge]

**[Gutter]**

[Menu] ▶ [Function Settings] ▶ [Printer] ▶ [Printer Settings] ▶ [Layout]

Offset the print position to adjust the width of the margin that will form the gutter. Specify the offset width in 0.5 mm increments in the plus (+) or minus (-) offset direction, in accordance with the edge specified in [Binding Location]. **[Binding Location](P. 325)**

**If [Binding Location] is set to [Long Edge]**

Specify the offset width by selecting a positive (+) value to bind on the left edge of the paper or a negative (-) value to bind on the right edge.



Specified as a positive (+) value



Specified as a negative (-) value

**If [Binding Location] is set to [Short Edge]**

Specify the offset width by selecting a positive (+) value to bind on the top edge of the paper or a negative (-) value to bind on the bottom edge.



Specified as a positive (+) value



Specified as a negative (-) value

-50.0 to **00.0** to +50.0 (mm)

**[Offset Short Edge] or [Offset Long Edge]**

[Menu] ▶ [Function Settings] ▶ [Printer] ▶ [Printer Settings] ▶ [Layout]

Offset the print position of text and images. Use this setting when the printed text and images are shifted towards one edge of the paper or when they extend beyond the print range. Specify the offset width as a positive (+) or negative (-) value in 0.5 mm increments for each paper edge direction and print side.

**To Offset Along the Short Edge (Horizontally)**

Specify the adjustment width by selecting a positive (+) value to adjust to the right on the paper or a negative (-) value to adjust to the left on the paper.

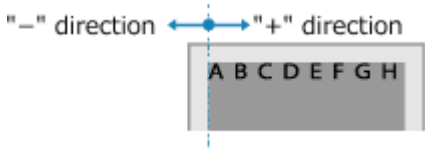

**To Offset Along the Long Edge (Vertically)**

Specify the adjustment width by selecting a positive (+) value to adjust down on the paper or a negative (-) value to adjust up on the paper.



-50.0 to **00.0** to +50.0 (mm)

## [Auto Error Skip]

[Menu] ▶ [Function Settings] ▶ [Printer] ▶ [Printer Settings]

Specify whether to continue printing if an error occurs during printing.  
It is recommended that the [Off] setting normally be used so that printing stops when an error occurs.

[Off]  
[On]

## [Timeout]

[Menu] ▶ [Function Settings] ▶ [Printer] ▶ [Printer Settings]

Specify the time from the start of waiting to receive print data until reception times out when print data reception is interrupted.

5 to **15** to 300 (sec.)

## [Personality]

[Menu] ▶ [Function Settings] ▶ [Printer] ▶ [Printer Settings]

This should normally be set to [Auto], in which the machine automatically identifies the received print data and switches to the appropriate operating mode.  
If the machine doesn't switch to the appropriate operating mode for some reason (such as an unknown print data format), set the operating mode manually.

[Auto]  
[PS]\*1  
[PCL]  
[PDF]  
[XPS]  
[Imaging]

\*1 May not be displayed depending on the model, the installed options, and other settings.

## [Escape Tray Mode]

[Menu] ▶ [Function Settings] ▶ [Printer] ▶ [Printer Settings]

Specify whether to feed paper from the multi-purpose tray when the appropriate paper is not loaded in the paper drawer while Paper Source Auto Selection is enabled.

[Off]  
[On]

## [Speed/Print Side Priority for 2-Sided]

[Menu] ▶ [Function Settings] ▶ [Printer] ▶ [Printer Settings]

Specify whether to print the last page on one side of the paper when using 2-sided printing and the last page number is odd, or the last page is blank or cannot be printed and ends with an odd page number.

- To print the last page on one side of the paper, select [Speed Priority].
- To print the last page on both sides of the paper, select [Print Side Priority].  
When using paper printed with a logo for example, selecting [Print Side Priority] aligns the orientation and print side with that of other pages.

[Speed Priority]  
[Print Side Priority]

## [Prioritize Multi-Purpose Tray]

[Menu] ▶ [Function Settings] ▶ [Printer] ▶ [Printer Settings]

Specify whether to give priority to paper feeding from the multi-purpose tray over feeding from the paper drawer when the machine automatically selects the correct paper source for the size of the paper to be printed. If you specify [On] in this setting and the same paper is loaded into both the multi-purpose tray and the paper drawer, paper is fed from the multi-purpose tray.

[Off]  
[On]

## [Check Paper Size in Tray]

[Menu] ▶ [Function Settings] ▶ [Printer] ▶ [Printer Settings]

Specify whether to determine the paper size in the paper source and the paper size in the printer driver. When [On] is selected, printing is canceled if the paper sizes do not match.

[Off]  
[On]

## [Recovery Printing]

[Menu] ▶ [Function Settings] ▶ [Printer] ▶ [Printer Settings]

Specify whether to resume printing from the page where an error that stops printing occurred after the error is resolved.

\* When [Off] is selected, the page where the error occurred is not printed. Printing resumes from the next page, but it may resume two pages later when using 2-sided printing and depending on when the error occurred.

[Off]  
[On]

## [UFR II]

[Menu] ▶ [Function Settings] ▶ [Printer] ▶ [Printer Settings]

Specify the print data processing method used when the UFR II Printer Driver is used.

### [Halftones]

[Menu] ▶ [Function Settings] ▶ [Printer] ▶ [Printer Settings] ▶ [UFR II]



Specify the print method used to reproduce halftones (intermediate areas between light and dark areas) according to the print data content.

**To print at high definition with clear text outlines**

Specify [Resolution]. This is useful for printing files with text and fine lines.

To print at a higher resolution than the [Resolution] setting, specify [High Resolution]. This is useful for printing data with fine lines and small text, such as CAD files.

\* Selecting [High Resolution] may reduce the consistency of textures.

**To print with highlighted contrast between light and dark areas**

Specify [Color Tone]. This is useful for printing image files such as photos.

**To print with smoother gradations and outlines**

Specify [Gradation]. This is useful for printing files such as figures that use tonal gradations.

[Resolution/Gradation]
[Text]
[Resolution]
[Color Tone]
[Gradation]
[High Resolution]
[Graphics]
[Resolution]
[Color Tone]
[Gradation]
[High Resolution]
[Image]
[Resolution]
[Color Tone]
[Gradation]
[High Resolution]

### [Paper Save]

[Menu] ► [Function Settings] ► [Printer] ► [Printer Settings] ► [UFR II]

Specify whether to disable output for blank pages included in the print data.

[Off]
[On]

## [PCL]

[Menu] ► [Function Settings] ► [Printer] ► [Printer Settings]

Specify the PCL printing settings, such as page layout and print quality.

### [Paper Save]

[Menu] ► [Function Settings] ► [Printer] ► [Printer Settings] ► [PCL]

Specify whether to disable output for blank pages included in print data.

[Off]
[On]

## [Orientation]

---

[Menu] ► [Function Settings] ► [Printer] ► [Printer Settings] ► [PCL]

Select [Portrait] (vertical orientation) or [Landscape] (horizontal orientation) as the page orientation.

[Portrait]  
[Landscape]

## [Font Number]

---

[Menu] ► [Function Settings] ► [Printer] ► [Printer Settings] ► [PCL]

Specify the font to use by selecting a corresponding font ID number.

\* You can print the PCL font list with font samples from the control panel. **▶ Printing and Viewing Reports and Lists(P. 265)**

0 to 54

## [Point Size]

---

[Menu] ► [Function Settings] ► [Printer] ► [Printer Settings] ► [PCL]

Set the font size in points, adjustable in 0.25 increments.

- You can specify this setting only when a proportionally-spaced scalable font is selected in [Font Number].

\* [Point Size] may not be displayed depending on the model, the installed options, and other settings.

4.00 to **12.00** to 999.75 (point)

## [Pitch]

---

[Menu] ► [Function Settings] ► [Printer] ► [Printer Settings] ► [PCL]

Set the font pitch, or cpi (characters per inch), adjustable in 0.01 increments.

- You can specify this setting only when a fixed-pitch scalable font or a bitmap font is selected in [Font Number].

\* [Pitch] may not be displayed depending on the model, the installed options, and other settings.

0.44 to **10.00** to 99.99 (cpi)

## [Form Lines]

---

[Menu] ► [Function Settings] ► [Printer] ► [Printer Settings] ► [PCL]

Set the number of lines printed on one page from 5 to 128.

- This setting is automatically changed according to the settings specified in [Default Paper Size] and [Orientation].

\* Depending on your country or region, the [Form Lines] setting may not be available, or its content or default setting may be different.

5 to **64** to 128 (lines)

## [Character Code]

---

[Menu] ► [Function Settings] ► [Printer] ► [Printer Settings] ► [PCL]

Select the character code that is best suited to the computer you are sending print data from.

- The specified setting is ignored when the character code is controlled by the font specified in [Font Number].

[DESKTOP]	[PC8]
[ISO11]	[PC850]
[ISO15]	[PC852]
[ISO17]	[PC858]
[ISO21]	[PC8DN]
[ISO4]	[PC8TK]
[ISO6]	[PIFONT]
[ISO60]	[PSMATH]
[ISO69]	[PSTEXT]
[ISOL1]	[ROMAN8]
[ISOL2]	[ROMAN9]
[ISOL5]	[VNINTL]
[ISOL6]	[VNMATH]
[ISOL9]	[VNUS]
[LEGAL]	[WIN30]
[MATH8]	[WINBALT]
[MCTEXT]	[WINL1]
[MSPUBL]	[WINL2]
[PC1004]	[WINL5]
[PC775]	

### [Custom Paper]

[Menu] ► [Function Settings] ► [Printer] ► [Printer Settings] ► [PCL]

Specify whether to set a custom paper size.  
Specify [On] to set the dimensions of the paper in [X dimension] and [Y dimension].

[Off]  
[On]

### [Unit of Measure]

[Menu] ► [Function Settings] ► [Printer] ► [Printer Settings] ► [PCL]

Select the unit of measurement used to set custom paper sizes.

\* Depending on your country or region, the [Unit of Measure] setting may not be displayed, or its content or default setting may be different.

[Millimeter]  
[Inch]

### [X dimension]

[Menu] ► [Function Settings] ► [Printer] ► [Printer Settings] ► [PCL]

Specify the horizontal dimension (short edge) of the custom paper.

\* [X dimension] may not be displayed depending on the model, the installed options, and other settings.

77 to 216 (mm)

### [Y dimension]

[Menu] ► [Function Settings] ► [Printer] ► [Printer Settings] ► [PCL]

Specify the vertical dimension (long edge) of the custom paper.

\* [Y dimension] may not be displayed depending on the model, the installed options, and other settings.

127 to **355** (mm)

### [Append CR to LF]

[Menu] ► [Function Settings] ► [Printer] ► [Printer Settings] ► [PCL]

Select whether to append a carriage return (CR) when the machine receives a line feed code (LF).

- If [Yes] is selected, the print position moves to the beginning of the next line when the machine receives an LF code.
- If [No] is selected, the print position moves to the next line, just under the received LF code.

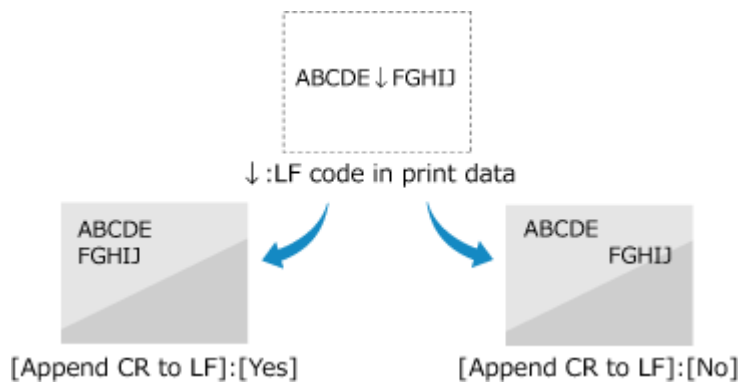

[Yes]

[No]

### [Enlarge A4 Print Width]

[Menu] ► [Function Settings] ► [Printer] ► [Printer Settings] ► [PCL]

Select whether to expand the width of the printable area of A4 size paper in portrait orientation to that of Letter size.

[Off]

[On]

### [Halftones]

[Menu] ► [Function Settings] ► [Printer] ► [Printer Settings] ► [PCL]

Specify the print method used to reproduce halftones (intermediate areas between light and dark areas) according to the print data content.

#### To print at high definition with clear text outlines

Specify [Resolution]. This is useful for printing files with text and fine lines.

To print at a higher resolution than the [Resolution] setting, specify [High Resolution]. This is useful for printing data with fine lines and small text, such as CAD files.

\* Selecting [High Resolution] may reduce the consistency of textures.

#### To print with highlighted contrast between light and dark areas

Specify [Color Tone]. This is useful for printing image files such as photos.

#### To print with smoother gradations and outlines

Specify [Gradation]. This is useful for printing files such as figures that use tonal gradations.

[Resolution/Gradation]  
[Text]

<b>[Resolution]</b>
[Color Tone]
[Gradation]
[High Resolution]
[Graphics]
[Resolution]
<b>[Color Tone]</b>
[Gradation]
[High Resolution]
[Image]
[Resolution]
<b>[Color Tone]</b>
[Gradation]
[High Resolution]

## [PS]

[Menu] ▶ [Function Settings] ▶ [Printer] ▶ [Printer Settings]

Specify the PS printing settings such as page layout and print quality.

\* [PS] may not be displayed depending on the model, the installed options, and other settings.

### [Job Timeout]

[Menu] ▶ [Function Settings] ▶ [Printer] ▶ [Printer Settings] ▶ [PS]

This setting enables you to specify the amount of time before a job times out.

- If a job has not finished within the set time limit, the job is automatically canceled.

0 to 3600 (sec.)

### [Print PS Errors]

[Menu] ▶ [Function Settings] ▶ [Printer] ▶ [Printer Settings] ▶ [PS]

This setting determines whether an error page is printed when an error is encountered.

[Off]  
[On]

### [Halftones]

[Menu] ▶ [Function Settings] ▶ [Printer] ▶ [Printer Settings] ▶ [PS]

Specify the print method used to reproduce halftones (intermediate areas between light and dark areas) according to the print data content.

#### To print with smoother gradations and outlines

Specify [Resolution]. This is useful for printing files such as figures that use tonal gradations.

#### To print with highlighted contrast between light and dark areas

Specify [Gradation]. This is useful for printing image files such as photos.

#### To print at high definition with clear text outlines

Specify [High Resolution]. This is useful for printing files with text and fine lines.

[Resolution/Gradation]  
[Text]

<b>[Resolution]</b>
[Gradation]
[High Resolution]
[Graphics]
<b>[Resolution]</b>
[Gradation]
[High Resolution]
[Image]
<b>[Resolution]</b>
[Gradation]
[High Resolution]

### [Grayscale Conversion]

[Menu] ► [Function Settings] ► [Printer] ► [Printer Settings] ► [PS]

Specify the conversion method when printing color data in black and white.

- Specify [sRGB] for black and white printing with smooth gradations to represent different colors.
- Specify [NTSC] for black and white printing that looks similar to NTSC television images.
- Specify [Uniform RGB] for uniform black and white printing of RGB over the entire document, based on the brightness.

[sRGB]
<b>[NTSC]</b>
[Uniform RGB]

### [PS Password Settings]

[Menu] ► [Function Settings] ► [Printer] ► [Printer Settings] ► [PS]

You can specify the password that restricts the use of the control command prepared by the PS printer.

- [SystemParamsPassword] is a password that allows changes to the system parameter, and [StartJobPassword] is a password that allows the startjob and exitserver operators to perform. For more information, check the PostScript language specifications.

\* If [StartJobPassword] is set but [SystemParamsPassword] is not set, password check will not be performed while performing the startjob or exitserver operator.

[SystemParamsPassword]
[StartJobPassword]

## [Imaging Settings]

[Menu] ► [Function Settings] ► [Printer] ► [Printer Settings]

Specify the print data processing method used for printing JPEG or TIFF format image files.

### [Halftones]

[Menu] ► [Function Settings] ► [Printer] ► [Printer Settings] ► [Imaging Settings]

Specify the print method used to reproduce halftones (intermediate areas between light and dark areas) according to the image content.

**To print with highlighted contrast between light and dark areas**

Specify [Gradation]. This is useful for printing image files such as photos.

**To print with smoother gradations and outlines**

Specify [Resolution]. This is useful for printing files such as figures that use tonal gradations.

**To print at high definition with clear text outlines**

Specify [High Resolution]. This is useful for printing files with text and fine lines.

[Gradation]
[Resolution]
[High Resolution]

**[PDF]**

[Menu] ► [Function Settings] ► [Printer] ► [Printer Settings]

Specify the print data processing method used for printing PDF format files.

**[Enlarge/Reduce to Fit Paper Size]**

[Menu] ► [Function Settings] ► [Printer] ► [Printer Settings] ► [PDF]

Specify whether to enlarge or reduce documents to fit the paper used for printing.

\* If you specify [On] in this setting, documents are enlarged or reduced while maintaining their aspect ratio.

[Off]
[On]

**[Enlarge Print Area]**

[Menu] ► [Function Settings] ► [Printer] ► [Printer Settings] ► [PDF]

Specify whether to print with the print area enlarged so that it occupies the entire paper, leaving no margins around the edges of the paper.

\* In some documents, specifying [On] in this setting may lead to images being printed with some of the edges cut off, or to smudging on some parts of the paper.

[Off]
[On]

**[N on 1]**

[Menu] ► [Function Settings] ► [Printer] ► [Printer Settings] ► [PDF]

Specify whether to reduce the size of a multi-page original and print the pages arranged on one sheet of paper. To print multiple pages on one sheet (N on 1), select the number of pages to be combined.

**Example:** To print a 4-page document on one side of the paper  
Select [4 on 1].

[Off]
[2 on 1]
[4 on 1]
[6 on 1]
[8 on 1]
[9 on 1]
[16 on 1]

**[Print Comments]**

[Menu] ► [Function Settings] ► [Printer] ► [Printer Settings] ► [PDF]

Specify whether to print the comments in a PDF file.  
If you specify [Auto] in this setting, the document and comments\*1 are printed.

\*1 This only applies to comments specified for printing within the PDF file.

[Off]  
[Auto]

## [Halftones]

[Menu] ▶ [Function Settings] ▶ [Printer] ▶ [Printer Settings] ▶ [PDF]

Specify the print method used to reproduce halftones (intermediate areas between light and dark areas) according to the print data content.

### To print with smoother gradations and outlines

Specify [Resolution]. This is useful for printing files such as figures that use tonal gradations.

### To print with highlighted contrast between light and dark areas

Specify [Gradation]. This is useful for printing image files such as photos.

### To print at high definition with clear text outlines

Specify [High Resolution]. This is useful for printing files with text and fine lines.

[Resolution/Gradation]  
[Text]  
[Resolution]  
[Gradation]  
[High Resolution]  
[Graphics]  
[Resolution]  
[Gradation]  
[High Resolution]  
[Image]  
[Resolution]  
[Gradation]  
[High Resolution]

## [Grayscale Conversion]

[Menu] ▶ [Function Settings] ▶ [Printer] ▶ [Printer Settings] ▶ [PDF]

Specify the conversion method when printing color data in black and white.

- Specify [sRGB] for black and white printing with smooth gradations to represent different colors.
- Specify [NTSC] for black and white printing that looks similar to NTSC television images.
- Specify [Uniform RGB] for uniform black and white printing of RGB over the entire document, based on the brightness.

[sRGB]  
[NTSC]  
[Uniform RGB]

## [XPS]

[Menu] ▶ [Function Settings] ▶ [Printer] ▶ [Printer Settings]



Specify the print data processing used for printing XPS format files.

**[Halftones]**

[Menu] ▶ [Function Settings] ▶ [Printer] ▶ [Printer Settings] ▶ [XPS]

Specify the print method used to reproduce halftones (intermediate areas between light and dark areas) according to the print data content.

**To print with smoother gradations and outlines**

Specify [Resolution]. This is useful for printing files such as figures that use tonal gradations.

**To print with highlighted contrast between light and dark areas**

Specify [Gradation]. This is useful for printing image files such as photos.

**To print at high definition with clear text outlines**

Specify [High Resolution]. This is useful for printing files with text and fine lines.

[Resolution/Gradation]
[Text]
<b>[Resolution]</b>
[Gradation]
[High Resolution]
[Graphics]
<b>[Resolution]</b>
[Gradation]
[High Resolution]
[Image]
<b>[Resolution]</b>
[Gradation]
[High Resolution]

**[Grayscale Conversion]**

[Menu] ▶ [Function Settings] ▶ [Printer] ▶ [Printer Settings] ▶ [XPS]

Specify the conversion method used when printing color data in black and white. This can be set separately for text, graphics (lines or figures), and images (photos).

- Specify [sRGB] for black and white printing with smooth gradations to represent different colors.
- Specify [NTSC] for black and white printing that looks similar to NTSC television images.
- Specify [Uniform RGB] for uniform black and white printing of RGB over the entire document, based on the brightness.

[Text]
[sRGB]
<b>[NTSC]</b>
[Uniform RGB]
[Graphics]
[sRGB]
<b>[NTSC]</b>
[Uniform RGB]
[Image]
[sRGB]
<b>[NTSC]</b>
[Uniform RGB]

### [Paper Save]

---

[Menu] ▶ [Function Settings] ▶ [Printer] ▶ [Printer Settings] ▶ [XPS]

Specify whether to disable output for blank pages included in the print data.

[Off]
[On]

### [Compressed Image Output]

---

[Menu] ▶ [Function Settings] ▶ [Printer] ▶ [Printer Settings] ▶ [XPS]

If the machine runs short of memory during printing, image quality may suffer. Specify whether to continue printing when this occurs.

- To continue printing even with degraded image quality, specify [Output] in this setting.
- To stop printing and display an error when image quality is severely degraded, specify [Display Error].

[Output]
[Display Error]

## [PDL Selection (Plug and Play)]

9664-07E

Specify which Page Description Language (PDL) to use when the machine is connected to a computer using Plug and Play.

\* Values in bold red text are the default settings for each item.

▶ **[Network]**(P. 339)

▶ **[USB]**(P. 339)

### [Network]

[Menu] ▶ [Function Settings] ▶ [Printer] ▶ [PDL Selection (Plug and Play)]

Specify the Page Description Language (PDL) to use when the machine is connected to a networked computer using Plug and Play.

When connecting the machine, select from the following:

- When connecting as a UFR II printer: [UFR II]
- When connecting as a PCL6 printer: [PCL6]
- When connecting as a PS printer: [PS]

<b>[UFR II]</b>
[PCL6]
[PS]*1

\*1 May not be displayed depending on the model, the installed options, and other settings.

### [USB]

[Menu] ▶ [Function Settings] ▶ [Printer] ▶ [PDL Selection (Plug and Play)]

Specify the Page Description Language (PDL) to use when the machine is connected to a computer via USB using Plug and Play.

- When connecting the machine as a printer, select from the following:
  - When connecting as a UFR II printer: [UFR II]
  - When connecting as a PCL6 printer: [PCL6]
  - When connecting as a PS printer: [PS]

<b>[UFR II]</b>
[PCL6]
[PS]*1

\*1 May not be displayed depending on the model, the installed options, and other settings.

## [Receive]

---

9664-OCF

Specify the settings for receiving I-Faxes.

▶ **[Common Settings](P. 340)**

▶ **[E-Mail Settings](P. 340)**

### [Common Settings]

[Menu] ▶ [Function Settings] ▶ [Receive]

Specify the settings for the action when receiving I-Faxes.

▶ **[Common Settings](P. 341)**

### [E-Mail Settings]

[Menu] ▶ [Function Settings] ▶ [Receive]

Specify the settings for printing received I-Faxes.

▶ **[E-Mail Settings](P. 342)**

## [Common Settings]

---

9664-07H

Specify the settings for the action when receiving I-Faxes.

\* Values in bold red text are the default settings for each item.

### [Continue Print. When Amount in Cart. Low]

[Menu] ▶ [Function Settings] ▶ [Receive] ▶ [Common Settings]

Specify whether to print received I-Faxes when a toner cartridge is low on toner.

- Printing when a toner cartridge is low on toner may lead to print results that are faint or faded. For this reason, this should normally be set to [Off]. When this setting is used and toner is low, received I-Faxes are stored in the machine's memory.
- If [On] is specified in this setting, received I-Faxes are not stored in the machine's memory. If this leads to print results that are too faint to read, you will need to ask the sender to re-send the I-Fax.

[Off]
[On]

## [E-Mail Settings]

9664-07J

Specify the settings for printing received I-Faxes.

\* Values in bold red text are the default settings for each item.

▶ **[Print on Both Sides]**(P. 342)

▶ **[RX Print Size]**(P. 342)

### [Print on Both Sides]

[Menu] ▶ [Function Settings] ▶ [Receive] ▶ [E-Mail Settings]

Specify whether to use 2-sided printing for received I-Faxes.

**[Off]**  
[On]

### [RX Print Size]

[Menu] ▶ [Function Settings] ▶ [Receive] ▶ [E-Mail Settings]

Specify the paper size for printing received I-Faxes.

**[A4]**  
[LTR]  
[LGL]  
[FOOLSCAP/FOLIO]  
[OFICIO]  
[Government-LTR]  
[Government-LGL]  
[India-LGL]  
[AUS-FOOLSCAP]  
[Brazil-OFICIO]  
[Mexico-OFICIO]

## [Management Settings]

---

Specify the settings for managing the machine users, the system, and other data.

- ▶ [User Management](P. 343)
- ▶ [Device Management](P. 343)
- ▶ [Remote UI Settings/Update Firmware](P. 343)
- ▶ [Data Management](P. 343)
- ▶ [Security Settings](P. 343)
- ▶ [Initialize All Data/Settings](P. 343)

### [User Management]

[Menu] ▶ [Management Settings]

Register and manage information on the machine's administrator and users.

- ▶ [User Management](P. 345)

### [Device Management]

[Menu] ▶ [Management Settings]

Specify and manage the settings for information and operations relating to the machine's hardware.

- ▶ [Device Management](P. 346)

### [Remote UI Settings/Update Firmware]

[Menu] ▶ [Management Settings]

Specify and manage the settings for information and operations relating to the machine's software.

- ▶ [Remote UI Settings/Update Firmware](P. 349)

### [Data Management]

[Menu] ▶ [Management Settings]

Manage or initialize stored data and the machine's settings.

- ▶ [Data Management](P. 351)

### [Security Settings]

[Menu] ▶ [Management Settings]

Specify and manage the security settings, such as the machine's authentication functions and system verification.

- ▶ [Security Settings](P. 353)

### [Initialize All Data/Settings]

[Menu] ▶ [Management Settings]

Initialize the settings and registered data to reset the machine to the factory settings.  **Initializing the Settings and Data(P. 273)**



## [User Management]

9664-07S

Register and manage information on the machine's administrator and users.

\* Values in bold red text are the default settings for each item.

🔴 [System Manager Information Settings](P. 345)

🔴 [Department ID Management](P. 345)

### [System Manager Information Settings]

[Menu] ▶ [Management Settings] ▶ [User Management]

Specify a System Manager ID and System Manager PIN to create a dedicated administrator account.

If needed, you can also specify the administrator's name.

Use Remote UI from a computer to specify other administrator information, such as the e-mail address. 🔴 **Setting the Department ID and PIN for the Administrator(P. 191)**

\* By default, the System Manager ID and System Manager PIN are not set. 🔴 **System Manager ID and PIN(P. 6)**

[System Manager ID and PIN]

[System Manager ID]

[System Manager PIN]

[System Manager Name]

### [Department ID Management]

[Menu] ▶ [Management Settings] ▶ [User Management]

To enhance security and manage function use and costs, assign a Department ID to users and groups that use the machine. 🔴 **Authenticating Users and Managing Groups with Department ID (Department ID Management) (P. 194)**

Set whether to enable Department ID Management. To register the Department ID and check the usage by Department ID, use Remote UI from a computer.

[Off]

[On]

## [Device Management]

9664-07U

Specify and manage settings for information and operations relating to the machine's hardware.

\* Values in bold red text are the default settings for each item.

- ▶ [Device Information Settings](P. 346)
- ▶ [Select Country/Region](P. 346)
- ▶ [Display Job Log](P. 346)
- ▶ [Displ. Consmbls. Info (RUI/Toner Status)](P. 347)
- ▶ [Notify to Check Paper Settings](P. 347)
- ▶ [Canon Genuine Mode](P. 347)

### [Device Information Settings]

[Menu] ▶ [Management Settings] ▶ [Device Management]

Specify a name to identify the machine and the installation location.

The information specified here appears in the Remote UI Portal page. ▶ **Portal Page of Remote UI(P. 259)**

[Device Name]
[Location]

### [Select Country/Region]

[Menu] ▶ [Management Settings] ▶ [Device Management]

Specify the country or region where the machine is used. The default setting may vary depending on the setting selected at initial power-ON.

\* Depending on your country or region, the [Select Country/Region] setting may not be available, or its content or default setting may be different.

[Austria (AT)]	[Luxembourg (LU)]
[Belarus (BY)]	[Netherlands (NL)]
[Belgium (BE)]	[Norway (NO)]
[Czech Republic (CZ)]	[Poland (PL)]
[Denmark (DK)]	[Portugal (PT)]
[Egypt (EG)]	[Russia (RU)]
[Finland (FI)]	[Saudi Arabia (SA)]
[France (FR)]	[Slovenia (SI)]
[Germany (DE)]	[South Africa (ZA)]
<b>[Great Britain (GB)]</b>	[Spain (ES)]
[Greece (GR)]	[Sweden (SE)]
[Hungary (HU)]	[Switzerland (CH)]
[Ireland (IE)]	[United Arab Emirates (AE)]
[Italy (IT)]	[Ukraine (UA)]
[Jordan (JO)]	[Other]

### [Display Job Log]

[Menu] ▶ [Management Settings] ▶ [Device Management]

Specify whether the logs for printing are shown on the Status Monitor screen.

- ▶ **[Status Monitor] Screen(P. 95)**
- ▶ **Checking Usage and Logs with Remote UI(P. 261)**
- ▶ **Printing and Viewing Reports and Lists(P. 265)**

[Off]  
[On]

## [Displ. Consmbls. Info (RUI/Toner Status)]

[Menu] ▶ [Management Settings] ▶ [Device Management]

Specify whether a button that accesses sites for purchasing toner cartridges is displayed in Toner Status and Remote UI. You can also specify whether Toner Status is used.

- Specify whether to show the button in Remote UI in [Displ. Consumables Purchase Button (RUI)].
- Specify whether to use Toner Status in [Toner Status] in the [Toner Status Settings].
- If you opt to use Toner Status, use [Displ. Consumables Purchase Button (RUI)] in the [Toner Status Settings] to specify whether to show the button.

Toner Status sends notification of the remaining amount of toner in the machine to the computer on which the tool is installed. Download Toner Status from the Canon website for your country/region, and install it on your computer.

<https://global.canon/en/support/>

\* If the machine is supplied with a CD-ROM or DVD-ROM, you can also use this to install Toner Status.

[Displ. Consumables Purchase Button (RUI)]  
[Off]  
[On]

[Toner Status Settings]  
[Off]  
[On]  
[Displ Cnsmb1 Purch Btn]  
[Off]  
[On]

## [Notify to Check Paper Settings]

[Menu] ▶ [Management Settings] ▶ [Device Management]

Specify whether the Notify to Check Paper Settings screen appears when the paper drawer is loaded into the machine.

- ▶ **Loading Paper in the Paper Drawer(P. 105)**

[Off]  
[On]

## [Canon Genuine Mode]

[Menu] ▶ [Management Settings] ▶ [Device Management]

Specify whether to switch to Canon Genuine Mode.

- Normally, there is no need to change this setting.

## Settings Menu Items

- Your Canon service representative may change this setting. If this setting is not displayed, contact the machine's administrator.

[Off]  
[On]

## [Remote UI Settings/Update Firmware]

---

9664-07W

Specify and manage the settings for information and operations relating to the machine's software.

▶ [Remote UI Settings](P. 349)

▶ [Update Firmware](P. 349)

### [Remote UI Settings]

[Menu] ▶ [Management Settings] ▶ [License/Other] or [Remote UI Settings/Update Firmware]

Specify the settings for using Remote UI and for Restrict Access for Remote UI.

▶ [Remote UI Settings](P. 350)

### [Update Firmware]

[Menu] ▶ [Management Settings] ▶ [License/Other] or [Remote UI Settings/Update Firmware]

Check the machine's firmware version and update the firmware via the Internet or a computer. ▶ **Updating the Firmware(P. 270)**

[Via PC]

[Via Internet]

[Version Information]

[Notification Settings]

[Off]

[On]

## [Remote UI Settings]

9664-07X

Specify the settings for using Remote UI and for Restrict Access for Remote UI.

\* Values in bold text are the default settings for each item.

▶ **[Use Remote UI](P. 350)**

▶ **[Remote UI Access Security Settings](P. 350)**

### [Use Remote UI]

[Menu] ▶ [Management Settings] ▶ [License/Other] or [Remote UI Settings/Update Firmware] ▶ [Remote UI Settings]

Specify whether to use Remote UI. ▶ **[Disabling Remote UI](P. 239)**

If you opt to use Remote UI, you can also specify whether to use TLS encryption for communication when using Remote UI. ▶ **[Using TLS](P. 209)**

[Off]
<b>[On]</b>
[Use TLS]
<b>[Off]</b>
[On]

### [Remote UI Access Security Settings]

[Menu] ▶ [Management Settings] ▶ [License/Other] or [Remote UI Settings/Update Firmware] ▶ [Remote UI Settings]

When using Remote UI, set this setting to [On], and set the Remote UI Access PIN. ▶ **[Setting the PIN to Use for Remote UI](P. 239)**

<b>[Off]</b>
[On]
[Remote UI Access PIN]

## [Data Management]

9664-07Y

Manage or initialize the data and settings on the machine.  
\* Values in bold red text are the default settings for each item.

- ▶ **[Import/Export](P. 351)**
- ▶ **[Enable Product Extended Survey Program](P. 351)**
- ▶ **[Initialize Key and Certificate](P. 351)**
- ▶ **[Initialize Menu](P. 351)**

### [Import/Export]

[Menu] ▶ [Management Settings] ▶ [Data Management]

Import or export the various settings.

When importing is completed, the machine restarts automatically.

- To import or export using the control panel, use a USB memory device. ▶ **Inserting and Removing a USB Memory Device(P. 129)**
- To import or export particular items, use Remote UI from a computer. ▶ **Importing and Exporting the Settings(P. 268)**

[Import]
[Export]

### [Enable Product Extended Survey Program]

[Menu] ▶ [Management Settings] ▶ [Data Management]

Specify whether to use the Product Extended Survey Program (a program for surveying machine usage).

The Product Extended Survey Program is installed at the same time as the drivers. It automatically sends monthly updates of information on device usage to Canon over a 10-year period. The program does not send personal information or any information other than that shown above.

[Off]
<b>[On]</b>

### [Initialize Key and Certificate]

[Menu] ▶ [Management Settings] ▶ [Data Management]

Initialize the key and certificate settings and CA certificate settings, and delete all keys and certificates other than pre-installed ones. ▶ **Initializing Specific Settings and Data(P. 273)**

### [Initialize Menu]

[Menu] ▶ [Management Settings] ▶ [Data Management]

Initialize the [Menu] settings in the [Home] screen. Select the settings to be initialized. ▶ **Initializing Specific Settings and Data(P. 273)**

## Settings Menu Items

[Preferences]  
[Adjustment/Maintenance]  
[Function Settings]  
[Management Settings]  
[Initialize All]



## [Security Settings]

Specify and manage security settings such as the machine's authentication functions and system verification.

\* Values in bold red text are the default settings for each item.

▶ [Authentication/Password Settings](P. 353)

▶ [Encryption Settings](P. 353)

▶ [Verify System at Startup](P. 353)

### [Authentication/Password Settings]

[Menu] ▶ [Management Settings] ▶ [Security Settings]

Configure the authentication functions for the machine.

▶ [Authentication/Password Settings](P. 354)

### [Encryption Settings]

[Menu] ▶ [Management Settings] ▶ [Security Settings]

Specify whether to restrict the use of weak encryption or keys and certificates that use weak encryption.

[Prohibit Use of Weak Encryption]

[Off]

[On]

[Prohibit Key/Cert. with Weak Encryption]

[Off]

[On]

### [Verify System at Startup]

[Menu] ▶ [Management Settings] ▶ [Security Settings]

Verify that the system has not been tampered with when starting up the machine.

#### If Tampering is Detected

- The machine switches to update standby mode. You need to update the firmware. ▶ **Updating the Firmware(P. 270)**
- If the screen remains blank after some time, system recovery may not be possible. Contact your dealer or service representative. ▶ **If the Problem Persists(P. 463)**

[Off]

[On]

# [Authentication/Password Settings]

9664-081

Specify the settings for the machine's authentication functions.

\* Values in bold red text are the default settings for each item.

## ◉ [Authentication Function Settings] (P. 354)

### [Authentication Function Settings]

[Menu] ▶ [Management Settings] ▶ [Security Settings] ▶ [Authentication/Password Settings]

Specify the settings for enhanced security using the authentication functions.

#### [Lockout Settings]

[Menu] ▶ [Management Settings] ▶ [Security Settings] ▶ [Authentication/Password Settings] ▶ [Authentication Function Settings]

Specify whether to switch to a state that does not permit login (lockout) for a set period if authentication fails. If you use lockout, you can also specify how many consecutive times authentication fails before lockout is invoked in [Lockout Threshold] and specify the length of the lockout period in [Lockout Period].

\* This does not apply to Department ID authentication.

[Enable Lockout]

**[Off]**

[On]

[Lockout Threshold]

**1** to 10 (times)

[Lockout Period]

**1** to 60 (min.)

## Settings that Can Be Imported and Exported

---

9664-082

You can view a list of support for importing and exporting the machine's settings.

- ▶[Preferences](P. 356)
- ▶[Adjustment/Maintenance](P. 360)
- ▶[Function Settings](P. 361)
- ▶[Management Settings](P. 363)

### NOTE

- See the following for information on how to import and export data.
  - ▶**Importing and Exporting the Settings(P. 268)**

## [Preferences]

Support for importing and exporting the [Preferences] is as shown below.

- ✓ : Can be imported or exported  
 — : Cannot be imported or exported

- ◻ [Display Settings](P. 356)
- ◻ [English Keyboard Layout](P. 356)
- ◻ [Timer/Energy Settings](P. 357)
- ◻ [Network](P. 357)
- ◻ [External Interface](P. 359)
- ◻ [Accessibility](P. 359)
- ◻ [Volume Settings](P. 359)

### [Display Settings]

Setting	Import and Export
[Default Screen after Startup/Restoration]	✓
[Button Display Order on Home Screen]	—
[Language]	✓
[Remote UI Language]	✓
[Millimeter/Inch Entry Switch]	✓
[Displ. Timing for Cartridge Prep. Notif.]	✓
[Display Notif. to Clean Fixing Assembly]	✓
[Show Warnings]	✓
[Action When Warning]	✓
[Display IP Address]	✓

### [English Keyboard Layout]

Setting	Import and Export
[English Keyboard Layout]	✓

## [Timer/Energy Settings]

Setting	Import and Export
[Current Date/Time Settings]	—
[Date/Time Settings]	✓
[Date Format]	✓
[Time Format]	✓
[Auto Reset Time]	✓
[Function After Auto Reset]	✓
[Auto Shutdown Time]	✓
[Auto Sleep Time]	✓
[Auto Sleep Daily Timer]	✓
[Sleep Mode Exit Time Settings]	✓

## [Network]

Setting	Import and Export	
[Select Wired/Wireless LAN]	✓	
[Wireless LAN Settings]	[Manually Enter Network Name]	✓
	[WPS Push Button Mode]	—
	[WPS PIN Code Mode]	—
	[Power Save Mode]	✓
	[Connection Information]	—
[Direct Connection Settings]	—	
[TCP/IP Settings]	[IPv4 Settings]	✓*1

Settings Menu Items

Setting	Import and Export
[IPv6 Settings]	✓
[WINS Settings]	✓
[LPD Settings]	✓
[RAW Settings]	✓
[WSD Settings]	✓
[IPP Print Settings]	✓
[Use HTTP]	✓
[Use IPsec]	—
[Port Number Settings]	✓
[MTU Size]	✓
[SNMP Settings]	✓
[Dedicated Port Settings]	✓
[Dedicated Port Authentication Method]	✓
[Waiting Time for Connection at Startup]	✓
[Ethernet Driver Settings]	✓
[IEEE 802.1X Settings]	—
[Firewall Settings]	✓
[Device Settings Management On/Off]	✓
[Monitoring Service]	—
[RMT-SW]	✓
[Initialize Network Settings]	—

\*1 The [PING Command] is " — ."

## [External Interface]

Setting	Import and Export
[USB Settings]	✓

## [Accessibility]

Setting	Import and Export
[Invert Screen Colors]	✓
[Brightness]	✓
[Contrast]	✓
[Message Display Time]	✓
[Scrolling Speed]	✓
[Cursor Movement Type]	✓

## [Volume Settings]

Setting	Import and Export
[Entry Tone]	✓
[Invalid Entry Tone]	✓
[Restock Supplies Tone]	✓
[Warning Tone]	✓
[Job Done Tone]	✓
[Energy Saver Alert]	✓

## [Adjustment/Maintenance]

9664-084

Support for importing and exporting the [Adjustment/Maintenance] is as shown below.

- ✓ : Can be imported or exported  
 — : Cannot be imported or exported

◉ [Adjust Image Quality] (P. 360)

◉ [Maintenance] (P. 360)

### [Adjust Image Quality]

Setting	Import and Export
[Printer Density]	✓
[Toner Save]	✓
[Adjust Print Position]	✓
[Special Processing]	✓

### [Maintenance]

Setting	Import and Export
[Clean Fixing Assembly]	—
[Control Condensation]	✓



## [Function Settings]

Support for importing and exporting the [Function Settings] is as shown below.

✓ : Can be imported or exported

— : Cannot be imported or exported

○ [Common](P. 361)

○ [Printer](P. 361)

○ [Receive](P. 362)

○ [Secure Print](P. 362)

### [Common]

Setting	Import and Export
[Paper Feed Settings]	✓
[Print Settings]	✓

### [Printer]

Setting	Import and Export
[Printer Settings]	[Action When Free Paper Size Mismatch] ✓
	[Copies] ✓
	[2-Sided Printing] ✓
	[Default Paper] ✓
	[Paper Size Override] ✓
	[Print Quality] ✓
	[Layout] ✓
	[Auto Error Skip] ✓
	[Timeout] ✓
	[Personality] ✓

## Settings Menu Items

Setting		Import and Export
	[Escape Tray Mode]	✓
	[Speed/Print Side Priority for 2-Sided]	✓
	[Prioritize Multi-Purpose Tray]	✓
	[Check Paper Size in Tray]	✓
	[Recovery Printing]	✓
	[UFR II]	✓
	[PCL]	✓
	[PS]	✓
	[Imaging Settings]	✓
	[PDF]	✓
	[XPS]	✓
[PDL Selection (Plug and Play)]	[Network]	—
	[USB]	✓

### [Receive]

Setting	Import and Export
[Common Settings]	✓
[E-Mail Settings]	✓

### [Secure Print]

Setting	Import and Export
[Secure Print]	✓

## [Management Settings]

Support for importing and exporting the [Management Settings] is as shown below.

✓ : Can be imported or exported

— : Cannot be imported or exported

- [User Management](P. 363)
- [Device Management](P. 363)
- [Remote UI Settings/Update Firmware](P. 364)
- [Data Management](P. 364)
- [Security Settings](P. 364)
- [Initialize All Data/Settings](P. 364)

### [User Management]

Setting	Import and Export
[System Manager Information Settings]	✓
[Department ID Management]	✓

### [Device Management]

Setting	Import and Export
[Device Information Settings]	✓
[Select Country/Region]	—
[Display Job Log]	✓
[Displ. Consmbls. Info (RUI/Toner Status)]	✓
[Notify to Check Paper Settings]	✓
[Canon Genuine Mode]	✓

## [Remote UI Settings/Update Firmware]

Setting	Import and Export
[Remote UI Settings]	—
[Update Firmware]	—

## [Data Management]

Setting	Import and Export
[Import/Export]	—
[Enable Product Extended Survey Program]	✓
[Initialize Key and Certificate]	—
[Initialize Menu]	—

## [Security Settings]

Setting	Import and Export
[Authentication/Password Settings]	—
[Encryption Settings]	—
[Verify System at Startup]	✓

## [Initialize All Data/Settings]

Setting	Import and Export
[Initialize All Data/Settings]	—

# Maintenance

<b>Maintenance</b> .....	366
<b>Cleaning the Machine</b> .....	368
Cleaning the Surface of the Machine .....	369
Cleaning the Fixing Assembly .....	370
<b>Replacing Consumables</b> .....	371
Replacing the Toner Cartridge .....	372
Checking the Remaining Amount of Consumables .....	377
List of Consumables .....	378
<b>Adjusting the Print Quality and Position</b> .....	380
Adjusting the Print Density .....	381
Adjusting the Print Position .....	382
<b>Moving the Machine</b> .....	384

# Maintenance

9664-087

To ensure safe and convenient use of the machine, daily maintenance that includes cleaning and replacement of consumables is required.

If you notice a deterioration in the print quality or frequent paper jams, perform cleaning and adjustment to improve it.

## Performing Maintenance Operations

In addition to performing regular maintenance, operations are required according to the machine status and print quality.

### Cleaning

Regularly clean the various parts of the machine. If the paper becomes dirty, or the print quality has deteriorated, clean the parts causing the problem according to the symptoms.

▶ **Cleaning the Machine(P. 368)**

### Replacing Consumables

If a message about consumables appears on the screen of the control panel or Remote UI, or the print quality deteriorates, replace the consumables.

▶ **Replacing Consumables(P. 371)**

### Adjusting the Print Quality and Position

If the print density varies, the image position is shifted, or the print results are otherwise not as expected, adjust the print quality and position according to the symptoms that occur.

▶ **Adjusting the Print Quality and Position(P. 380)**

## Changing the Installation Location

When moving the machine, perform the prescribed procedure to prevent accident or damage.

▶ **Moving the Machine(P. 384)**

## IMPORTANT

### Maintenance and Inspections

- The minimum holding period for performance parts for repairs and toner cartridge is seven (7) years after production of the machine model is discontinued.
- If a problem occurs during operation, see the following:

▶ **Troubleshooting(P. 388)**

If the problem still cannot be resolved or you think the machine needs to be checked, contact your dealer or service representative. ▶ **If the Problem Persists(P. 463)**

### Installation

- If you find the machine's operation to be noisy in some operating modes or due to your surroundings, we recommend setting up the machine in a separate location from your office.
- Water droplets (condensation) may form inside the machine if the room where the machine is installed is heated rapidly, or if the machine is moved from a cool, dry location to a warm, humid location. Using the machine under these conditions may result in problems such as paper jams, poor print quality, or faults. Let the machine adjust to the ambient temperature and humidity for at least two hours before use.
- Machines with storage devices such as hard disks may not operate properly when used at high altitudes (3,000 meters above sea level or higher).

## ■ See Also

**Checking the Required Troubleshooting Solutions from the Symptoms**

You can check the required maintenance operations and settings according to the status of the machine and the error description.

▶ **Paper Jams(P. 389)**

▶ **Problems with Printing Results(P. 399)**

▶ **Paper and Paper Feeding Problems(P. 418)**

#### **Viewing the Number of Printed Pages and Machine Usage**

As a guide to when to perform maintenance, you can view the number of printed pages using the counter and view the usage of the machine from reports and lists.

▶ **Monitoring the Usage(P. 263)**

## Cleaning the Machine

---

9664-088

To ensure efficient use of the machine, regularly clean the various parts and keep them clean. If the paper becomes dirty, or the print quality has deteriorated, clean the parts causing the problem according to the symptoms.

### Parts to Clean on a Regular Basis

Clean the surface (a) frequently.

#### ▶ Cleaning the Surface of the Machine (P. 369)

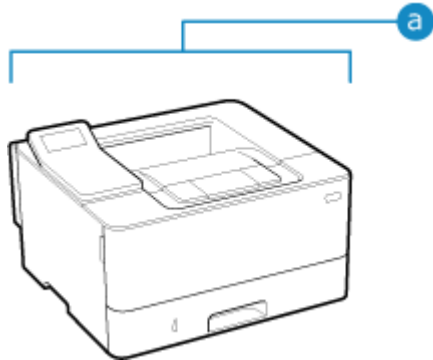

### Parts to Clean When Symptoms Occur

If the paper becomes dirty or print quality has deteriorated, clean the fixing assembly (b) inside the machine.

#### ▶ Cleaning the Fixing Assembly (P. 370)

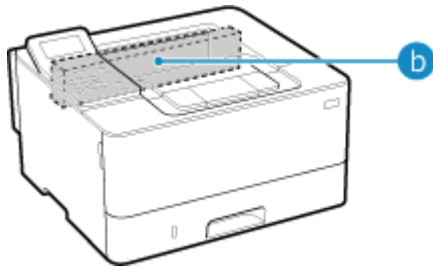



# Cleaning the Surface of the Machine

9664-089

Regularly clean the surface of the machine to keep it clean. In addition, remove dust from the ventilation holes to ensure efficient ventilation and cooling of the inside of the machine.

## NOTE

- Black dots in the surface of the machine are due to the use of recycled materials and are not a quality problem.

### 1 Turn OFF the power and remove the power cord from the outlet. ▶Turning OFF the Machine(P. 84)

Turning OFF the machine deletes any data waiting to be printed.

### 2 Wipe the surface of the machine and the ventilation slots.



- Wipe with a soft cloth soaked in water or diluted neutral detergent and wrung out.
- For the location of the ventilation slots, see the part names on the front of the machine. ▶Front Side(P. 10)

### 3 Allow the parts to fully dry.

### 4 Plug the power cord into the outlet, and turn ON the machine. ▶Turning ON the Machine(P. 83)

# Cleaning the Fixing Assembly

9664-08A

If the printout is smudged, the fixing assembly may be dirty. In this case, you can clean the fixing assembly using paper.

The fixing assembly cannot be cleaned when data is waiting to be printed or a toner cartridge has reached the end of its lifetime.

## Required Preparations

- Check that there is enough amount of toner remaining in the toner cartridge. [▶Checking the Remaining Amount of Consumables\(P. 377\)](#)

**1** On the control panel, select [Menu] in the [Home] screen, and press **OK**. [▶\[Home\] Screen\(P. 94\)](#)

**2** Press [Adjustment/Maintenance] **▶** **OK** **▶** [Maintenance] **▶** **OK** **▶** [Clean Fixing Assembly] **▶** **OK**.

⇒ The available paper sizes and types are displayed on the confirmation screen.

**3** Check that available paper is loaded, and then press **OK**.

⇒ The paper is fed to the machine, and cleaning starts.

When cleaning is completed, a sheet of paper with a printed image (pattern) is output.

# Replacing Consumables

---

9664-08E

If a message about consumables appears on the screen of the control panel or Remote UI, or the print quality deteriorates, replace the consumables.

You can view the current remaining amount of consumables on the control panel and Remote UI. For the consumable item names and number of sheets that can be printed, see the list of consumables.

- ▶ **Replacing the Toner Cartridge(P. 372)**
- ▶ **Checking the Remaining Amount of Consumables(P. 377)**
- ▶ **List of Consumables(P. 378)**

## Replacing the Toner Cartridge

9664-08F

Replace the toner cartridge at the appropriate time according to messages that appear and a change in print quality.

Before replacing the toner cartridge, check the precautions in Important Safety Instructions. [▶Manuals of the Machine\(P. 466\)](#)

[▶When to Replace the Toner Cartridge\(P. 373\)](#)

[▶Before Replacing Toner Cartridge\(P. 373\)](#)

[▶Replacing Toner Cartridge\(P. 375\)](#)

### CAUTION

- Do not touch the contacts (a) inside the machine. Doing so may result in a fault.

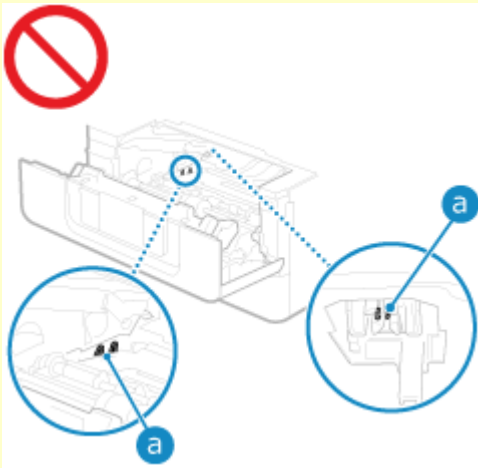

### IMPORTANT

- Be sure to hold the toner cartridge using the handle.

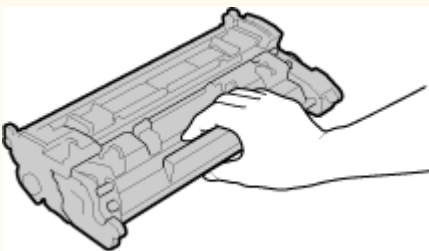

- Do not touch the toner cartridge memory (a) or the electrical contacts (b). To avoid scratching the surface of the drum inside the machine or exposing it to light, do not open the drum protective shutter (c).

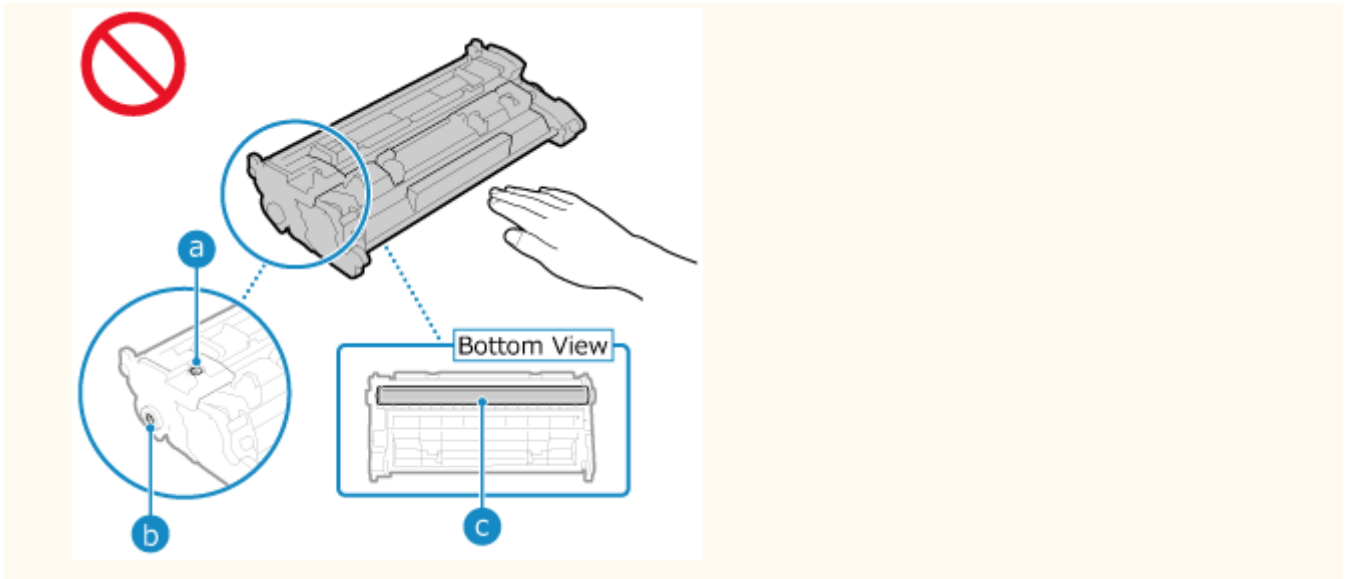

## When to Replace the Toner Cartridge

### When a Message Appears on the Screen of the Control Panel or Remote UI

Follow the message on the screen to prepare a new toner cartridge and replace the old one. Print quality may suffer if you continue using the toner cartridge without replacing it.

For details about the message and how to resolve it, see the following:

▶ **A Message Appears (P. 445)**

### When Print Quality Deteriorates

If printouts show any of the symptoms below, the toner cartridge is near the end of their lifetime. It is recommended to replace the toner cartridge even if a message does not appear.

Streaks appear



Printing is uneven



Toner smudges and splatters appear



White spots appear



Partially faded



The entire background is darkened



## Before Replacing Toner Cartridge

Perform the following procedure before replacing the toner cartridge. The message on the screen may disappear, and the print quality may improve.

**1** Open the front cover.

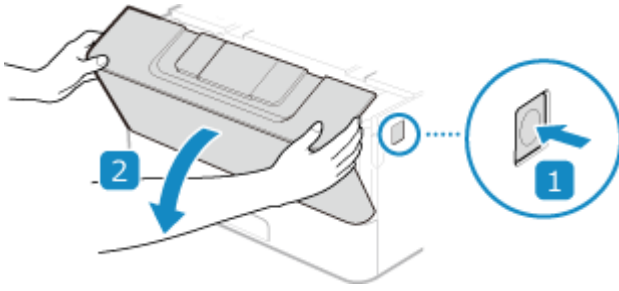

**2** Remove the toner cartridge.

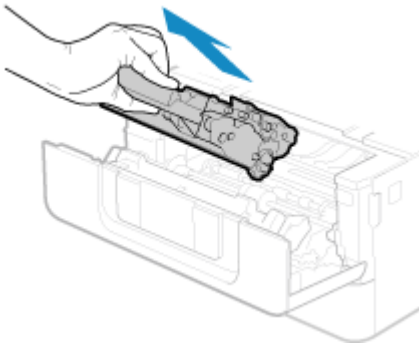

**3** Shake the toner cartridge five or six times to evenly distribute the toner inside the cartridge.

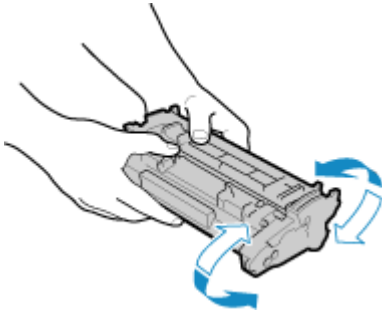

**4** Install the toner cartridge.

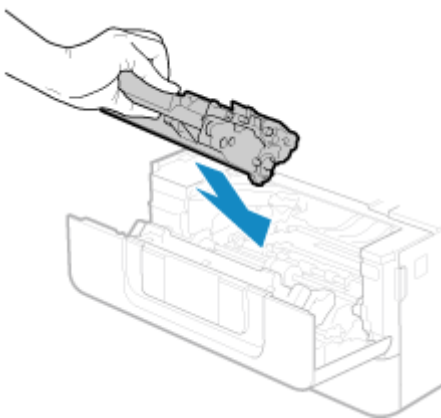

Fully push it in until it cannot go any further.

**5** Close the front cover.

## Replacing Toner Cartridge

- 1** Open the front cover.

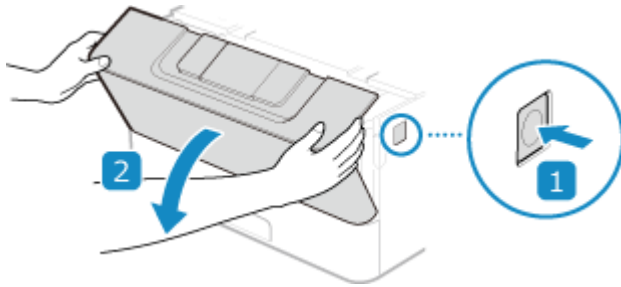

- 2** Remove the toner cartridge.

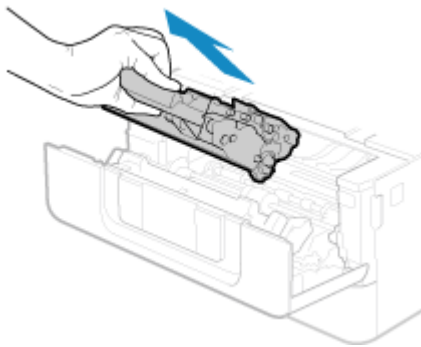

- 3** Remove the replacement toner cartridge from the protective case.

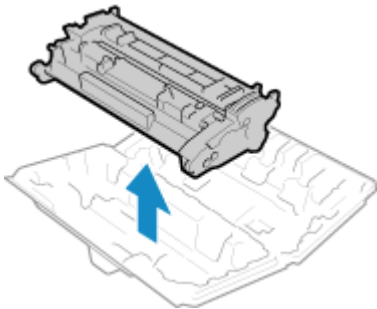

- 4** Shake the toner cartridge five or six times to evenly distribute the toner inside the cartridge.

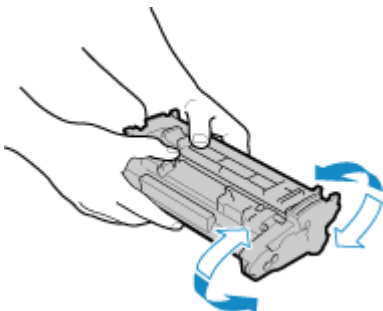

**5** Install the toner cartridge.

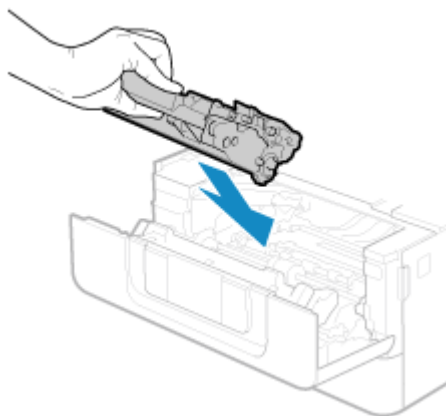

Fully push it in until it cannot go any further.

**6** Close the front cover.



# Checking the Remaining Amount of Consumables

9664-08H

You can view the percentage of the current remaining amount of toner in the toner cartridge in increments of 10%. Check the remaining amount of toner in the toner cartridge, for example, to see if you need to prepare a new toner cartridge before printing a large volume document.

\* The displayed value for the remaining amount of toner in the toner cartridge is for reference and may not indicate the actual amount remaining.

This section describes how to view this information using the control panel.

You can also check this information using Remote UI from a computer. ▶ **Managing the Machine from a Computer (Remote UI)(P. 255)**

**1** Press the Status Monitor key (  ) on the control panel. ▶ **Control Panel(P. 14)**

**2** Press [Device Status] ▶  ▶ [Cartridge Level] ▶ .

⇒ The remaining amount of toner in the toner cartridge is displayed.

**3** Check the remaining amount of toner in the toner cartridge.

## NOTE

- You can configure the settings to notify you to prepare a new toner cartridge when the current toner cartridge reaches a specified amount. ▶ **[Displ. Timing for Cartridge Prep. Notif.](P. 282)**

# List of Consumables

9664-08J

The item names of the machine consumables and number of sheets that can be printed are shown below. In addition, precautions must be taken when handling and storing consumables. See also "Important Safety Instructions." [Manuals of the Machine\(P. 466\)](#)

For optimum print quality, using Canon genuine Toner, Cartridge and Parts is recommended.



## ■ Toner Cartridge

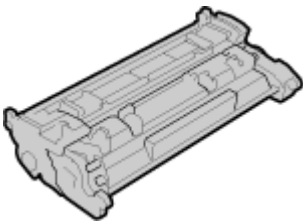

### Supplied Toner Cartridge

The average number of sheets that can be printed\*<sup>1</sup> with the supplied toner cartridge is shown below.

\*<sup>1</sup> The average yield is based on "ISO/IEC 19752" (the global standard related to "Method for the determination of toner cartridge yield for monochromatic electrophotographic printers and multi-function devices that contain printer components" issued by International Organization for Standardization (ISO)) when printing A4 size plain paper with the default print density setting.

1,500 sheets

### Replacement Toner Cartridge

The Canon genuine toner cartridge for replacement and average number of sheets that can be printed\*<sup>1</sup> are shown below.

For optimum print quality, using Canon genuine toner cartridges is recommended.

\*<sup>1</sup> The average yield is based on "ISO/IEC 19752" (the global standard related to "Method for the determination of toner cartridge yield for monochromatic electrophotographic printers and multi-function devices that contain printer components" issued by International Organization for Standardization (ISO)) when printing A4 size plain paper with the default print density setting.

**Canon Cartridge 070**  
3,000 sheets

**Canon Cartridge 070 H**  
10,200 sheets

## CAUTION

Store toner cartridges as described below. Storing toner cartridges in an improper location or environment may cause problems such as data loss.

- Store unopened until immediately prior to use.

## CAUTION

- Do not store toner cartridges upright or upside down.
- Do not store toner cartridges in the following locations:
  - Locations exposed to open flames
  - Locations exposed to direct sunlight or bright light for five minutes or more
  - Locations exposed to excessively salty air
  - Locations heavily exposed to corrosive gases (e.g. aerosol sprays or ammonia)
  - Very hot and/or humid locations
  - Locations subject to dramatic changes in temperature and humidity likely to cause condensation
  - Very dusty locations
  - Locations within the reach of children
  - Locations close to products affected by magnetism (e.g. floppy disks or disk drives)
- Store the packaging material safely for future use. It will be needed for situations such as storing the machine with the toner cartridges removed.
- Canon reserves the right to reposition, reshape, add, or remove packaging material without notice.
- Store toner cartridges in the following conditions:
  - Storage temperature range: 0 - 35 °C
  - Storage humidity range: 35% to 85% RH (relative humidity, condensation-free)\*1

\*1 Even within the approved storage humidity range, water droplets (condensation) may develop inside the toner cartridge if the temperatures inside and outside the toner cartridge differ. Condensation will adversely affect the print quality.

## IMPORTANT

### Be careful of counterfeit toner cartridges

- Please be aware that there are counterfeit Canon toner cartridges in the marketplace. Use of counterfeit toner cartridge may result in poor print quality or machine performance. Canon is not responsible for any malfunction, accident or damage caused by the use of counterfeit toner cartridge. For more information, see <https://global.canon/ctc/>.

## NOTE

- The toner cartridge may need to be replaced before reaching the average number of sheets that can be printed depending on the installation environment, paper size to be printed, and original type.
- Shortening the automatic shutdown time from the default setting (4 hours), may reduce the lifetime of the toner cartridge.

## Adjusting the Print Quality and Position

---

9664-08K

If the print density varies, the image position is shifted, or the print results are otherwise not as expected, adjust the print quality and position according to the symptoms that occur.

**Printed image is too light/dark. ▶ Adjusting the Print Density(P. 381)**



**Printed position is closer to one side or sticking out. ▶ Adjusting the Print Position(P. 382)**



## Adjusting the Print Density

9664-0CH

If print results are too dark or too faint, adjust the print density.

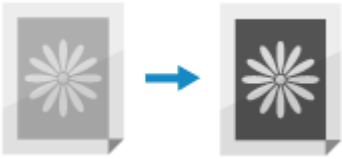

Use the control panel to perform adjustment. You cannot perform adjustment using Remote UI from a computer.

- 1** On the control panel, select [Menu] in the [Home] screen, and press **OK**. **▶**[Home] Screen(P. 94)
- 2** Press [Adjustment/Maintenance] **▶** **OK** **▶** [Adjust Image Quality] **▶** **OK** **▶** [Printer Density] **▶** **OK**.
- 3** Adjust the density.

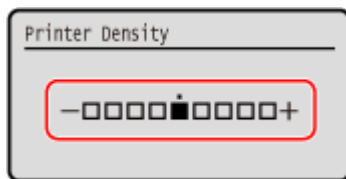

Specify [+] to increase the density and [-] to reduce it.

- 4** Press **OK**.

## Adjusting the Print Position

9664-08S

If text or images are printed off-center or outside of the printable range, you can adjust the print position to improve printing results.

You can specify the adjustment direction and width for each paper source and print side (front and back side).



Use the control panel to perform adjustment. You cannot perform adjustment using Remote UI from a computer.

- 1 On the control panel, select [Menu] in the [Home] screen, and press **OK**. **▶**[Home] Screen(P. 94)
- 2 Press [Adjustment/Maintenance] **▶** **OK** **▶** [Adjust Image Quality] **▶** **OK** **▶** [Adjust Print Position] **▶** **OK**.

⇒ The [Adjust Print Position] screen is displayed.

- 3 Select the paper source for which you want to adjust the print position.
- 4 Select a combination of the adjustment direction and print side.

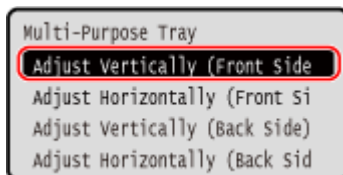

**Example:** When adjusting the print position of the front side of the paper in the vertical direction Select [Adjust Vertically (Front Side)].

- 5 Enter the adjustment value, and press **OK**.

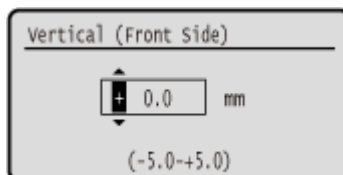

Specify the adjustment direction using + and -, and specify the adjustment width in units of 0.1 mm.

### ■ When Adjusting Vertically

Specify the adjustment width by selecting a positive value to adjust down on the paper or a negative value to adjust up on the paper.



### ■ When Adjusting Horizontally

Specify the adjustment width by selecting a positive value to adjust to the right on the paper or a negative value to adjust to the left on the paper.

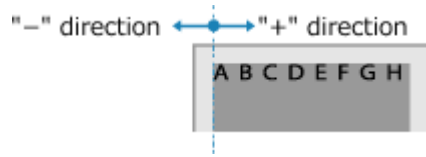

# Moving the Machine

The machine is a heavy object. When moving the machine for cleaning or to change locations, be sure to perform the procedure below to prevent injury, accident, or damage to the machine.

## ! IMPORTANT

- If the machine is to be transported for relocation, removals, etc., take the following steps to prevent damage and faults during transportation:
  - Remove the toner cartridge.
  - Securely pack the machine in the original packaging (box) and packing materials.

### 1 Turn OFF the machine. ▶Turning OFF the Machine(P. 84)

Turning OFF the machine deletes any data waiting to be printed.

### 2 Unplug the power cord in the order shown.

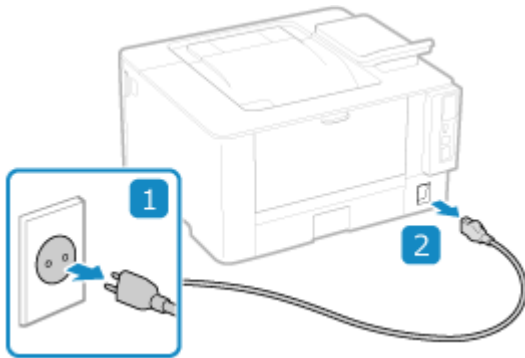

### 3 Unplug all cables and cords connected to the machine.

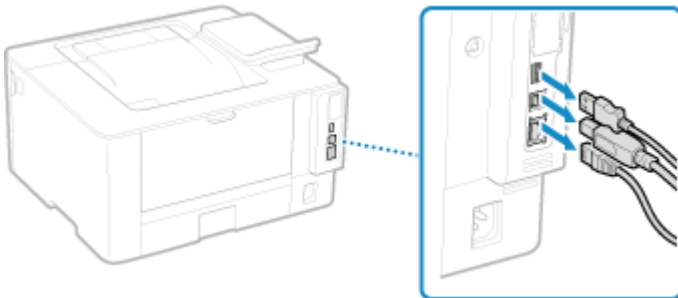

\* The number of connected cables and cords varies depending on the usage environment.

### 4 When moving the machine a long distance, remove the toner cartridge to prevent spilling of toner. ▶Replacing Toner Cartridge(P. 375)

### 5 Pull out the paper drawer.



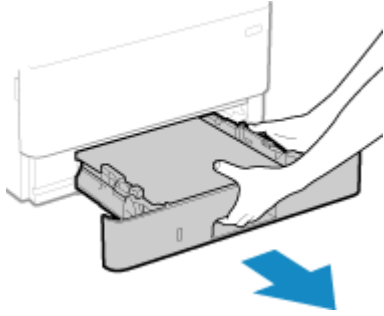

Make sure to hold the paper drawer with both hands, and pull it out gently. Otherwise, you may damage the paper drawer by dropping it, if it slides out too easily.

## 6 Close the front cover, multi-purpose tray, and any other covers or trays.

## 7 Grab the lift handles, and lift up the machine to move it.

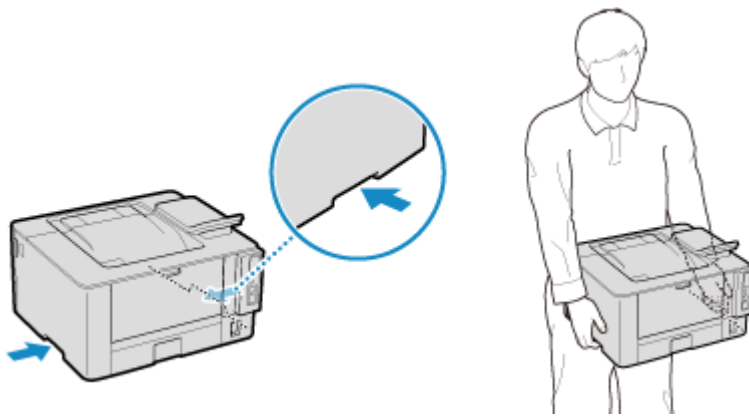

- The machine is a heavy object. For the dimensions and weight of the machine, see the basic specifications. ▶ **Basic Specifications(P. 24)**
- When the optional Cassette Feeding Module-AH is installed, remove it and move it separately, rather than lifting it with the machine.

## 8 Gently lower the machine.

For the installation procedure after moving, see "Setup Guide." ▶ **Manuals of the Machine(P. 466)**

# Troubleshooting

<b>Troubleshooting</b> .....	388
<b>Paper Jams</b> .....	389
Paper Jams Inside the Machine .....	390
Paper Jams in a Paper Source .....	395
Paper Jams That Occur Repeatedly .....	397
<b>Problems with Printing Results</b> .....	399
Toner Smudges and Splatters Appear .....	401
Streaks Appear .....	402
Printing Is Uneven .....	404
Printed Paper Is Blank .....	405
Smudge Marks Appear on the Edge of Printouts .....	406
Text or Images Are Blurry .....	407
Printouts Have Ghost Images .....	408
Printouts Are Faded .....	409
The Edge of the Page Is Not Printed .....	411
The Background Is Generally Dark .....	412
White Spots Appear .....	413
Smudge Marks Appear on the Back Side of Printouts .....	415
Printouts Are Skewed .....	416
The Printed Barcode Cannot be Scanned .....	417
<b>Paper and Paper Feeding Problems</b> .....	418
Paper Creases .....	419
Paper Curls .....	420
Paper Is Not Fed or Two or More Sheets Are Fed Together .....	421
<b>Setting Up</b> .....	422
The Machine Connected via WSD Port Is Not Displayed During Driver Installation .....	423
Cannot Connect to Wireless LAN .....	424
<b>Network</b> .....	425
Cannot Switch to Wireless LAN .....	426
Cannot Find the Print Server to Connect to .....	427
Cannot Connect to a Shared Printer .....	428
Cannot Find the IP Address of the Machine .....	429
AirPrint Does Not Work .....	430
<b>Printing</b> .....	431

Cannot Print .....	432
Cannot Print (Wireless LAN) .....	433
Cannot Print (Wired LAN) .....	435
Cannot Print (USB Connection) .....	436
Cannot Print (via Print Server) .....	437
Printing Is Slow .....	438
<b>Management Functions and Environment Settings</b> .....	439
Cannot Access Remote UI .....	440
Changing the Volume of the Confirmation Sound and Warning Tone .....	441
Changing the Time Until Sleep Mode .....	442
Lost Department ID or PIN for the Administrator .....	443
Checking the Items That Can Be Configured on the Machine and Their Settings .....	444
<b>A Message Appears</b> .....	445
<b>An Error Code Is Displayed</b> .....	458
<b>If the Problem Persists</b> .....	463

# Troubleshooting

---

9664-08W

This chapter describes how to troubleshoot problems and answers frequently asked questions.

Select an item to check from the contents or the list below.

You can click [  ] at the top of the screen to search for the message or error code (three-digit number starting with #) that appears on the control panel, and check how to troubleshoot problems.

## ■ Frequently Asked Questions

▶ **Lost Department ID or PIN for the Administrator(P. 443)**

▶ **Cannot Print(P. 432)**

▶ **[The memory is full.] Is Displayed on the Control Panel, and the Operation Cannot Be Performed.(P. 457)**

## ■ Frequently Asked Questions about Operations

### **I Want to Print on an Envelope.**

Load the envelope in the multi-purpose tray, taking care to check the orientation of the envelope and that the correct side faces up.

Then, set the paper size and type according to the placed envelope.

Next, use the print driver of the computer to set the paper size of the document and the paper size to print, and then perform printing.

▶ **Preparations and Orientation for Loading Envelopes(P. 113)**

▶ **Specifying the Paper Size and Type(P. 119)**

▶ **Printing from a Computer(P. 154)**

# Paper Jams

If paper jams in the machine, [Paper jammed.] appears on control panel. Press **▶**, and follow the displayed instructions on how to clear the paper jam.

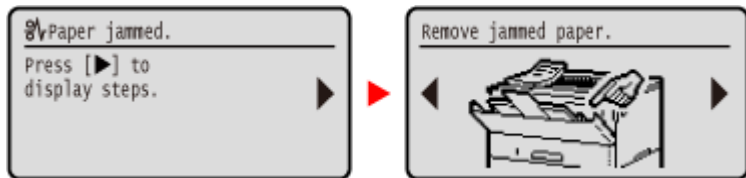

For details about clearing paper jams from various parts of the machine, see below.

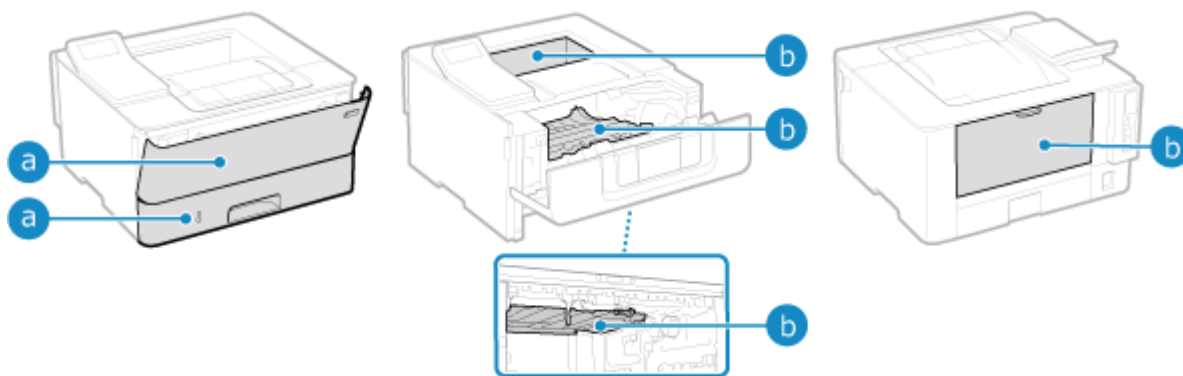

- a** Multi-purpose Tray, and Paper Drawer
  - ▶ **Paper Jams in a Paper Source(P. 395)**
- b** Output Tray, inside the machine, 2-sided transport guide, and Rear Side
  - ▶ **Paper Jams Inside the Machine(P. 390)**

## CAUTION

**Do not forcibly remove the jammed paper from the machine.**

- Forcibly removing the paper may result in personal injury or damage parts of the machine. If you cannot remove the paper, contact your dealer or service representative. ▶ **If the Problem Persists(P. 463)**

**When All Paper Jams Have Been Cleared**

- Immediately remove your hands from the machine and optional equipment so that your clothing and hands do not get caught in the rollers.

## IMPORTANT

**When clearing paper jams, do not turn the power OFF.**

- Data being printed is erased when you turn the power OFF.

**When the Paper Gets Torn**

- Be sure to remove it so that no pieces remain.

# Paper Jams Inside the Machine

9664-0CK

Remove the jammed paper from the location where it occurred. If the paper tears, ensure that no pieces are left behind.

- ▶ Paper jam inside the machine or in the rear side(P. 390)
- ▶ Paper jam in the 2-sided transport guide(P. 393)

## Paper jam inside the machine or in the rear side

Removing paper jammed inside the machine or in the rear side.

If you cannot remove the paper, do not try to remove it forcibly. Check the control panel, and remove the jammed paper from another location.

### 1 Open the front cover

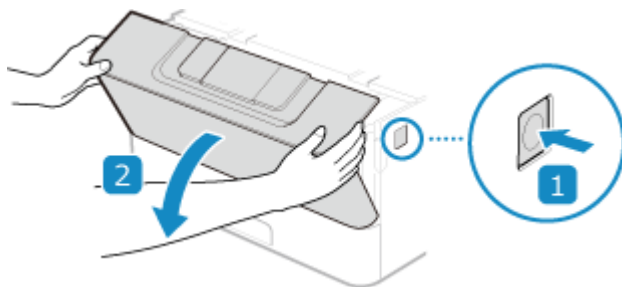

### 2 Remove the toner cartridge

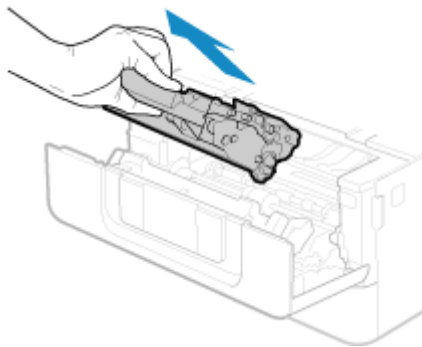

### 3 Removing paper jammed inside the machine

- 1 While holding the green knob on the front, lift up the transport guide

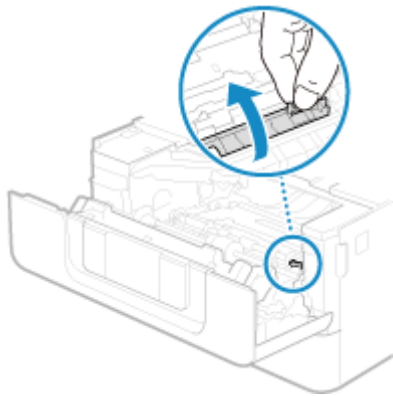

Do not release the transport guide until you have returned it to its original position in step 3.

- 2** Gently pull out the paper.

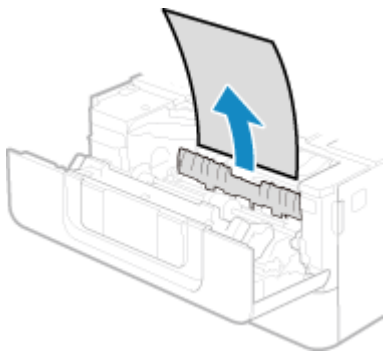

- 3** Slowly return the transport guide to its original position

- 4** While holding the green knob at the back, lift up the transport guide

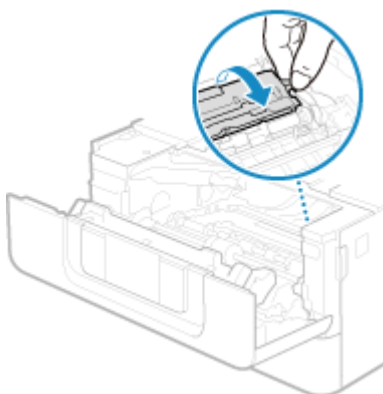

Do not release the transport guide until you have returned it to its original position in step 6.

- 5** Gently pull out the paper.

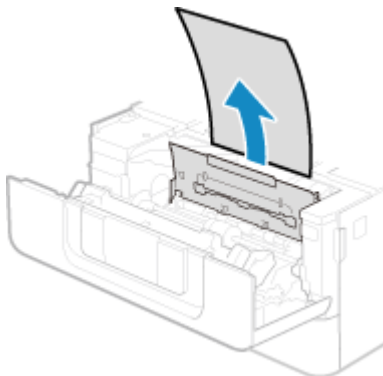

- 6** Slowly return the transport guide to its original position

## 4 Removing paper jammed in the rear side

- 1 Open the rear cover.

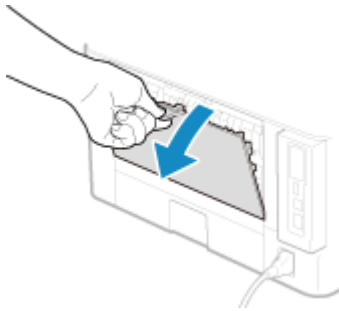

- 2 Gently pull out the paper.

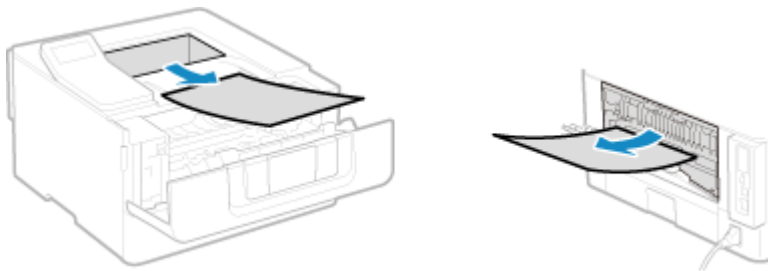

Pull the jammed paper out in whichever direction makes removal easiest.

- 3 Close the rear cover.

## 5 Install the toner cartridge

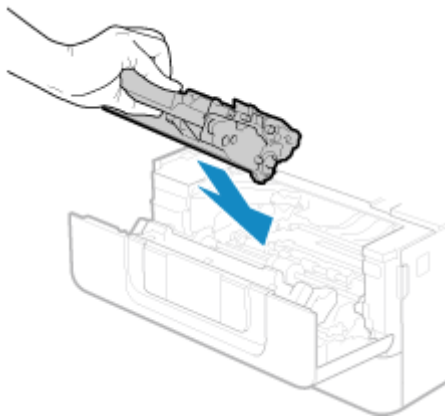

## 6 Close the rear cover.

- ➡ The message [Paper jammed.] disappears, and printing resumes automatically.  
If printing does not resume automatically, try printing again.

### NOTE

#### If Paper Jams Occur Repeatedly

- Check the status of the machine and paper. [▶ Paper Jams That Occur Repeatedly\(P. 397\)](#)



## Paper jam in the 2-sided transport guide

If you cannot remove the paper, do not try to remove it forcibly. Check the control panel, and remove the jammed paper from another location.

### 1 Pull out the paper drawer

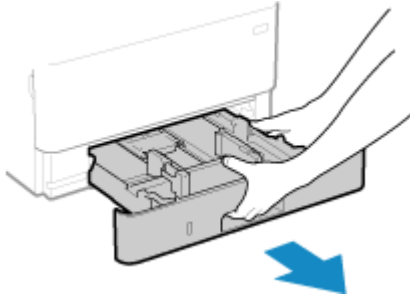

Always hold the paper drawer with both hands and pull it out gently. If you pull the drawer out with only one hand, it may be too heavy to hold, causing it to fall and be damaged.

### 2 While holding the green knob, lower the 2-sided transport guide

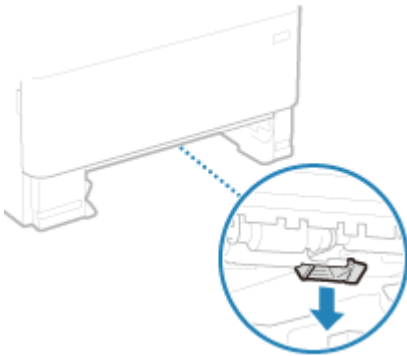

### 3 Gently pull out the paper

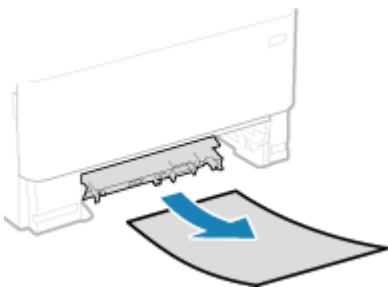

### 4 Return the 2-sided transport guide

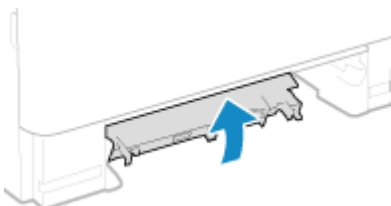

Close it firmly until you hear a click.

## 5 Load the paper drawer into the machine

## 6 When [Is all of the jammed paper removed?] appears, press [Yes] ► **OK**.

- The message [Paper jammed.] disappears, and printing resumes automatically.  
If printing does not resume automatically, try printing again.

### NOTE

#### If Paper Jams Occur Repeatedly

- Check the status of the machine and paper. ► **Paper Jams That Occur Repeatedly(P. 397)**

# Paper Jams in a Paper Source

9664-090

Remove the jammed paper from the location where it occurred. If the paper tears, be sure to remove the parts so that no pieces remain.

▶ **Paper Jams in the Multi-purpose Tray(P. 395)**

▶ **Paper Jams in the Paper Drawer(P. 395)**

## Paper Jams in the Multi-purpose Tray

Remove the jammed paper from the multi-purpose tray or inside the machine. If you cannot remove the paper, do not try to remove it forcibly. Check the control panel, and remove the jammed paper from another location.

**1** If there is other paper loaded in the multi-purpose tray, remove that paper.

**2** Gently pull out the paper.

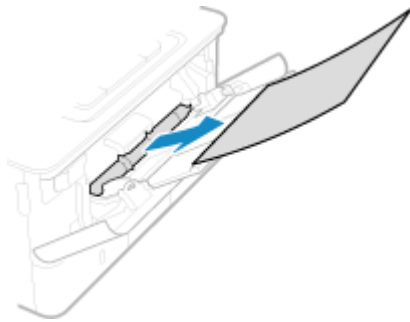

**3** When [Is all of the jammed paper removed?] appears, press [Yes] ▶ **OK**.

⇒ The message [Paper jammed.] disappears, and printing resumes automatically. If printing does not resume automatically, try printing again.

## NOTE

### If Paper Jams Occur Repeatedly

- Check the status of the machine and paper. ▶ **Paper Jams That Occur Repeatedly(P. 397)**

## Paper Jams in the Paper Drawer

Remove the paper loaded in the paper drawer. If you cannot remove the paper, do not try to remove it forcibly. Check the control panel, and remove the jammed paper from another location.

**1** Pull out the paper drawer, and remove it while lifting the front side.

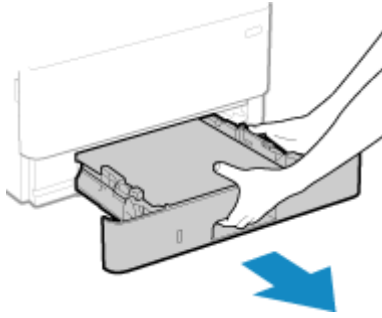

Always hold the paper drawer with both hands and pull it out gently. If you pull the drawer out with only one hand, it may be too heavy to hold, causing it to fall and be damaged.

**2 Gently pull out the paper.**

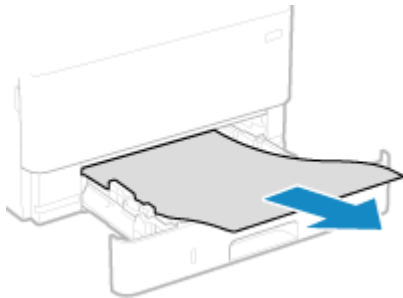

**3 Load the paper drawer into the machine.**

**4 If the optional Cassette Feeding Module-AH is installed, remove the paper while following 1 to 3 above.**

**5 When [Is all of the jammed paper removed?] appears, press [Yes] > .**

⇒ The message [Paper jammed.] disappears, and printing resumes automatically.  
If printing does not resume automatically, try printing again.

**NOTE**

**If Paper Jams Occur Repeatedly**

- Check the status of the machine and paper.  **Paper Jams That Occur Repeatedly(P. 397)**

# Paper Jams That Occur Repeatedly

9664-091

Troubleshoot by checking the items below.

## Are There Paper Scraps or Foreign Objects Inside the Machine?

Remove any paper scraps or foreign objects. **▶ Paper Jams (P. 389)**

## Are You Using Appropriate Paper?

Check whether the paper in the machine is usable, and replace it with appropriate paper, as needed.

**▶ Usable Paper (P. 18)**

**▶ Loading Paper (P. 104)**

## Is Paper Loaded Correctly?

- Fan the paper thoroughly in small batches so that it is not stuck together.
- Align the edges by tapping the paper on a flat surface a few times before loading the paper. **▶ Loading Paper (P. 104)**
- Make sure the loaded paper does not exceed the load limit line or load limit guide ( **a** ).

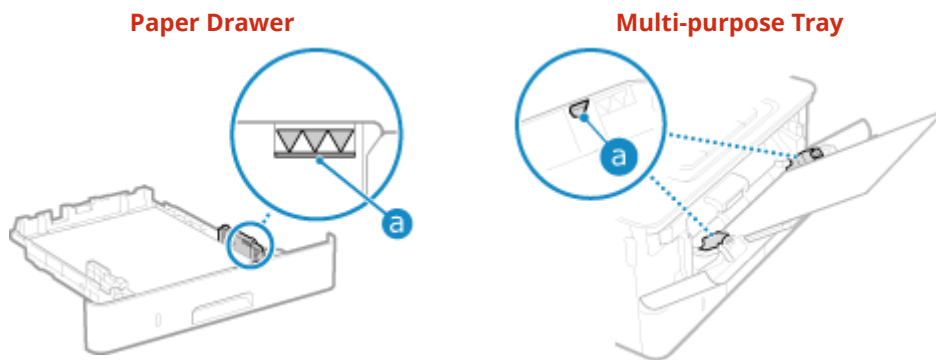

- Check that the paper guides are aligned with the markings and are not too loose or too tight.

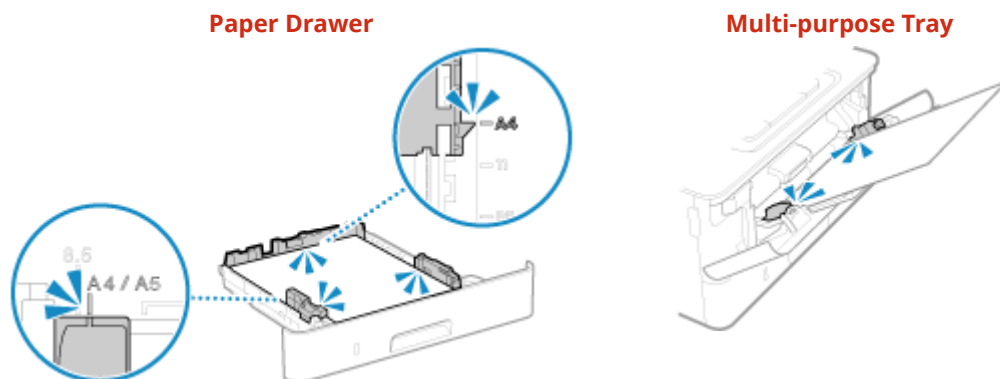

## Do Paper Jams Occur When Printing on the Back Side of Printed Paper?

Flatten the edges of the paper to thoroughly remove any curls.

\* When printing on the back side of printed paper, you can only use paper printed with this machine. Do not use paper printed with another printer or multifunction machine, as this can cause paper jams or damage the machine.

## Do Paper Jams Occur When Printing on Paper in the Optional Cassette Feeding Module-AH?

---

Reinstall Cassette Feeding Module-AH. For details about installing Cassette Feeding Module-AH, see "Setup Guide." [▶Manuals of the Machine\(P. 466\)](#)

## Problems with Printing Results

9664-092

If printouts show any of the symptoms below, check how to troubleshoot the problem based on the symptom.



▶ **Toner Smudges and Splatters Appear(P. 401)**

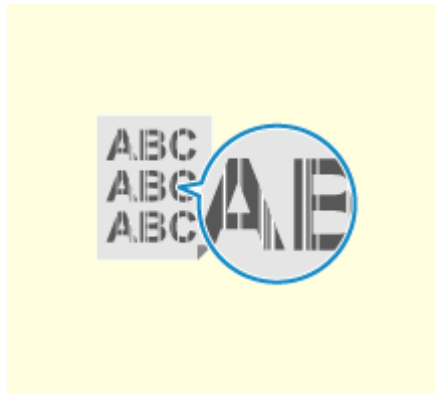

▶ **Streaks Appear(P. 402)**



▶ **Printing Is Uneven(P. 404)**

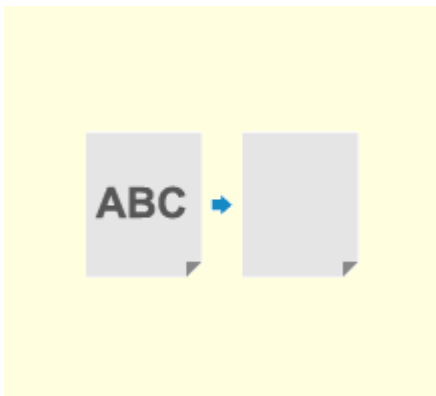

▶ **Printed Paper Is Blank(P. 405)**

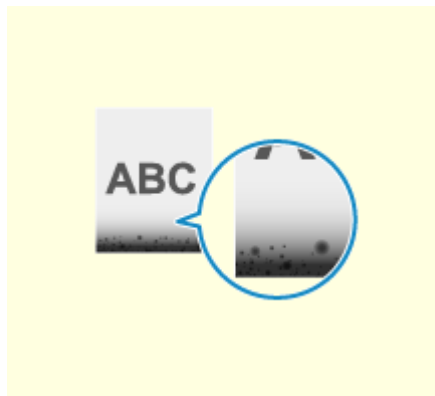

▶ **Smudge Marks Appear on the Edge of Printouts(P. 406)**



▶ **Text or Images Are Blurry(P. 407)**

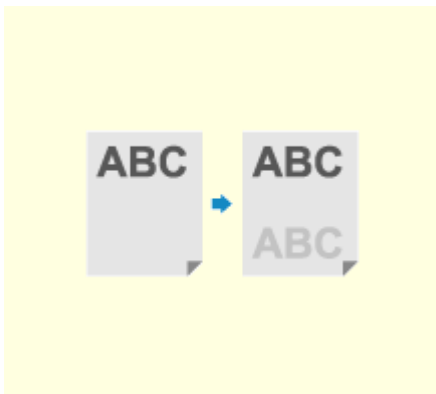

▶ **Printouts Have Ghost Images(P. 408)**



▶ **Printouts Are Faded(P. 409)**

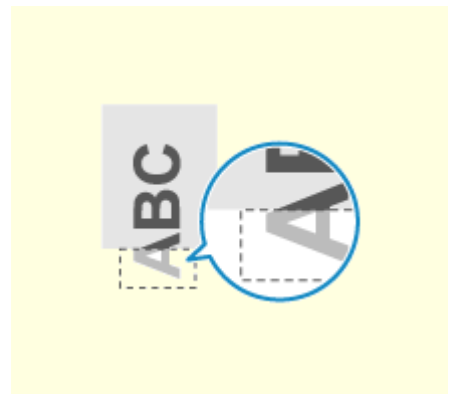

▶ **The Edge of the Page Is Not Printed(P. 411)**



▶ **The Background Is Generally Dark(P. 412)**



▶ **White Spots Appear(P. 413)**

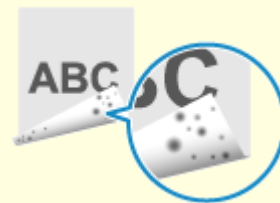

▶ **Smudge Marks Appear on the Back Side of Printouts(P. 415)**

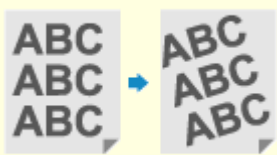

▶ **Printouts Are Skewed(P. 416)**



▶ **The Printed Barcode Cannot be Scanned(P. 417)**



# Toner Smudges and Splatters Appear

9664-093

Troubleshoot by checking in the following order:

- ▶ **Step 1: Checking the Paper(P. 401)**
- ▶ **Step 2: Checking the Toner Cartridge(P. 401)**
- ▶ **Step 3: Checking the Usage Environment of the Machine(P. 401)**
- ▶ **Step 4: Checking the Maintenance Status(P. 401)**

## Step 1: Checking the Paper

### Are You Using Appropriate Paper?

Check whether the paper in the machine is usable, and replace it with appropriate paper, as needed.

- ▶ **Usable Paper(P. 18)**
- ▶ **Loading Paper(P. 104)**

## Step 2: Checking the Toner Cartridge

### Check the Remaining Amount of Toner in the Toner Cartridge.

Check the remaining amount of toner in the toner cartridge and replace the cartridge that is low on toner.







- ▶ **Checking the Remaining Amount of Consumables(P. 377)**
- ▶ **Replacing the Toner Cartridge(P. 372)**

\* Depending on the usage condition of the machine, the actual remaining amount of toner may be lower than indicated or the parts may be deteriorated. If the problem persists, replace the toner cartridge.

## Step 3: Checking the Usage Environment of the Machine

### Are You Using the Machine in an Environment with Low Humidity?

Setting [Low Humidity Mode] to [Mode 1] may solve the problem. If that does not work, select [Mode 2].

[Home] screen on the control pane | ▶ [Menu] ▶  ▶ [Adjustment/Maintenance] ▶  ▶ [Adjust Image Quality] ▶  ▶ [Special Processing] ▶  ▶ [Low Humidity Mode] ▶  ▶ [Mode 1] or [Mode 2] ▶ 

\* Enabling this setting may reduce the density or create fading in a humid environment.

## Step 4: Checking the Maintenance Status

### Have You Cleaned the Fixing Assembly?

These symptoms may occur when the fixing assembly is dirty. In this case, clean the fixing assembly. ▶ **Cleaning the Fixing Assembly(P. 370)**

# Streaks Appear

9664-094

Troubleshoot by checking in the following order:

- ▶ **Step 1: Checking the Paper(P. 402)**
- ▶ **Step 2: Checking the Toner Cartridge(P. 402)**
- ▶ **Step 3: Checking the Usage Environment of the Machine(P. 402)**
- ▶ **Step 4: Checking the Maintenance Status(P. 403)**
- ▶ **Step 5: Checking for Streaking at the Paper Edges(P. 403)**

## Step 1: Checking the Paper

### Are You Using Appropriate Paper?

Check whether the paper in the machine is usable, and replace it with appropriate paper, as needed.

- ▶ **Usable Paper(P. 18)**
- ▶ **Loading Paper(P. 104)**

## Step 2: Checking the Toner Cartridge

### Check the Remaining Amount of Toner in the Toner Cartridge.

Check the remaining amount of toner in the toner cartridge, and replace any toner cartridge, as needed.

- ▶ **Checking the Remaining Amount of Consumables(P. 377)**
- ▶ **Replacing the Toner Cartridge(P. 372)**

\* Depending on the usage condition of the machine, the actual remaining amount of toner may be lower than indicated or the parts may be deteriorated. If the problem persists, replace the toner cartridge.

## Step 3: Checking the Usage Environment of the Machine

### Are You Using the Machine in an Environment with Sudden Temperature Changes?

Sudden temperature changes can create condensation, which can result in faded or blurry images and text. Setting [Control Condensation] to [On] may solve the problem.

[Home] screen on the control panel ▶ [Menu] ▶ **OK** ▶ [Adjustment/Maintenance] ▶ **OK** ▶ [Maintenance] ▶ **OK** ▶ [Control Condensation] ▶ **OK** ▶ [On] ▶ **OK**

\* During condensation removal, a blank sheet of paper may be output without being printed correctly. If you set this to [On], you can set whether to restrict printing.

\* If you set this to [On], you must keep the machine ON to continuously remove the condensation. The Auto Shutdown Time setting is disabled.

### Is the Machine Installed in a Location Subject to Strong Wind Such as from an Air Conditioner?

If so, adjust the air direction and volume of the air conditioner. If that does not work, setting [Switch Paper Feed Method] to [Print Side Priority] may improve the problem.

[Home] on the control panel ▶ [Menu] ▶ **OK** ▶ [Function Settings] ▶ **OK** ▶ [Common] ▶ **OK** ▶ [Paper Feed Settings] ▶ **OK** ▶ [Switch Paper Feed Method] ▶ **OK** ▶ [Print Side Priority] ▶ **OK**

\* When you select [Print Side Priority], the printing speed for 1-Sided printing will decrease.

## Step 4: Checking the Maintenance Status

### Have You Cleaned the Fixing Assembly?

These symptoms may occur when the fixing assembly is dirty. In this case, clean the fixing assembly. ▶  
**Cleaning the Fixing Assembly(P. 370)**

## Step 5: Checking for Streaking at the Paper Edges

### Do Streaks Appear at the Paper Edges?

Setting [Rdc. Wrinkles(Humidity)/Streaks] to [On] may solve the problem.

[Home] on the control panel ▶ **OK** ▶ [Menu] ▶ **OK** ▶ [Adjustment/Maintenance] ▶ **OK** ▶ [Adjust Image Quality] ▶ **OK** ▶ [Special Processing] ▶ **OK** ▶ [Rdc. Wrinkles(Humidity)/Streaks] ▶ **OK** ▶ [On] ▶ **OK**

\* Specifying [On] decreases the printing speed.

# Printing Is Uneven

9664-095

Troubleshoot by checking in the following order:

- ▶ **Step 1: Checking the Paper(P. 404)**
- ▶ **Step 2: Checking the Toner Cartridge(P. 404)**
- ▶ **Step 3: Checking the Usage Environment of the Machine(P. 404)**

## Step 1: Checking the Paper

### Are You Using Appropriate Paper?

Check whether the paper in the machine is usable, and replace it with appropriate paper, as needed.

- ▶ **Usable Paper(P. 18)**
- ▶ **Loading Paper(P. 104)**

## Step 2: Checking the Toner Cartridge

### Check the Remaining Amount of Toner in the Toner Cartridge.

Check the remaining amount of toner in the toner cartridge and replace the cartridge that are low on toner.

- ▶ **Checking the Remaining Amount of Consumables(P. 377)**
- ▶ **Replacing the Toner Cartridge(P. 372)**

\* Depending on the usage condition of the machine, the actual remaining amount of toner may be lower than indicated or the parts may be deteriorated. If the problem persists, replace the toner cartridge.

## Step 3: Checking the Usage Environment of the Machine

### Are You Using the Machine in an Environment with Sudden Temperature Changes?

Sudden temperature changes can create condensation, which can result in faded or blurry images and text. Setting [Control Condensation] to [On] may solve the problem.

[Home] screen on the control panel ▶ [Menu] ▶ **OK** ▶ [Adjustment/Maintenance] ▶ **OK** ▶  
 [Maintenance] ▶ **OK** ▶ [Control Condensation] ▶ **OK** ▶ [On] ▶ **OK**

\* During condensation removal, a blank sheet of paper may be output without being printed correctly. If you set this to [On], you can set whether to restrict printing.

\* If you set this to [On], you must keep the machine ON to continuously remove the condensation. The Auto Shutdown Time setting is disabled.

### Is the Machine Installed in a Location Subject to Strong Wind Such as from an Air Conditioner?

If so, adjust the air direction and volume of the air conditioner.

If that does not work, setting [Switch Paper Feed Method] to [Print Side Priority] may improve the problem.

[Home] on the control panel ▶ [Menu] ▶ **OK** ▶ [Function Settings] ▶ **OK** ▶ [Common] ▶ **OK** ▶ [Paper Feed Settings] ▶ **OK** ▶ [Switch Paper Feed Method] ▶ **OK** ▶ [Print Side Priority] ▶ **OK**

\* When you select [Print Side Priority], the printing speed for 1-Sided printing will decrease.

# Printed Paper Is Blank

---

9664-096

Troubleshoot by checking the items below.

## **Is Condensation Removal Being Performed?**

---

Check the control panel, and wait for condensation removal to finish.

# Smudge Marks Appear on the Edge of Printouts

---

9664-097

Troubleshoot by checking in the following order:

## Are You Using Appropriate Paper?

---

- Check whether the paper in the machine is usable, and replace it with appropriate paper, as needed.
  - ▶ **Usable Paper(P. 18)**
  - ▶ **Loading Paper(P. 104)**
- Set the paper size and type correctly according to the loaded paper. ▶ **Specifying the Paper Size and Type(P. 119)**

## Are You Printing to the Edge of the Paper Without Margins?

---

This symptom may occur when the margin is set to none in the printer driver. To print with this machine, a margin of 5 mm (10 mm at the top and bottom of an envelope) is required.

On the [Printing preferences] screen of the printer driver, configure the following setting to provide a margin.

[Finishing] tab ▶ [Advanced Settings] ▶ [Expand Print Region and Print] ▶ [Off]

## Have You Cleaned the Fixing Assembly?

---

These symptoms may occur when the fixing assembly is dirty. In this case, clean the fixing assembly. ▶ **Cleaning the Fixing Assembly(P. 370)**

# Text or Images Are Blurry

9664-098

Troubleshoot by checking the following steps:

- 🔴 **Step 1: Checking the Paper(P. 407)**
- 🔴 **Step 2: Checking the Usage Environment of the Machine(P. 407)**

## Step 1: Checking the Paper

### Are You Using Appropriate Paper?

Check whether the paper in the machine is usable, and replace it with appropriate paper, as needed.

- 🔴 **Usable Paper(P. 18)**
- 🔴 **Loading Paper(P. 104)**

### Is the Paper Stained According to the Paper Type or Usage Environment?

Setting [Correct Blurry Image] to [Mode 1] may solve the problem. If that does not work, try specifying [Mode 2], [Mode 3] and then [Mode 4] in sequence.





[Home] screen on the control panel ▶ [Menu] ▶  ▶ [Adjustment/Maintenance] ▶  ▶ [Adjust Image Quality] ▶  ▶ [Special Processing] ▶  ▶ [Correct Blurry Image] ▶  ▶ select the mode ▶ 

\* Enabling this setting may lower the print density or slow down printing. It may also make outlines less distinct or make them slightly rougher.

## Step 2: Checking the Usage Environment of the Machine

### Are You Using the Machine in an Environment with Sudden Temperature Changes?







Sudden temperature changes can create condensation, which can result in faded or blurry images and text. Setting [Control Condensation] to [On] may solve the problem.

[Home] screen on the control panel ▶ [Menu] ▶  ▶ [Adjustment/Maintenance] ▶  ▶ [Maintenance] ▶  ▶ [Control Condensation] ▶  ▶ [On] ▶ 

- \* During condensation removal, a blank sheet of paper may be output without being printed correctly. If you set this to [On], you can set whether to restrict printing.
- \* If you set this to [On], you must keep the machine ON to continuously remove the condensation. The Auto Shutdown Time setting is disabled.

### Are You Using the Machine in an Environment with Low Humidity?

Setting [Low Humidity Mode] to [Mode 1] may solve the problem. If that does not work, specify [Mode 2].

[Home] screen on the control panel ▶ [Menu] ▶  ▶ [Adjustment/Maintenance] ▶  ▶ [Adjust Image Quality] ▶  ▶ [Special Processing] ▶  ▶ [Low Humidity Mode] ▶  ▶ [Mode 1] or [Mode 2] ▶ 

\* Enabling this setting may reduce the density or create fading in a humid environment.

# Printouts Have Ghost Images

9664-099

Troubleshoot by checking the following steps:

- ▶ **Step 1: Checking the Paper and Toner Cartridge(P. 408)**
- ▶ **Step 2: Checking the Occurrence of Ghost Images(P. 408)**
- ▶ **Step 3: Checking the Maintenance Status of the Machine(P. 408)**

## Step 1: Checking the Paper and Toner Cartridge

### Are You Using Appropriate Paper?

Check whether the paper in the machine is usable, and replace it with appropriate paper, as needed.

- ▶ **Usable Paper(P. 18)**
- ▶ **Loading Paper(P. 104)**

### Have the Toner Cartridge Reached the End of Their Lifetime?

Parts inside the toner cartridge may have deteriorated. If this symptom occurs, it is recommended to replace the toner cartridge regardless of the remaining amount of toner or messages displayed. ▶ **Replacing the Toner Cartridge(P. 372)**

## Step 2: Checking the Occurrence of Ghost Images

### Do Ghost Images Appear on the Same Page?

Setting [High Humidity Mode] to [On] may solve the problem.

[Home] screen on the control panel ▶ **OK** ▶ [Menu] ▶ **OK** ▶ [Adjustment/Maintenance] ▶ **OK** ▶ [Adjust Image Quality] ▶ **OK** ▶ [Special Processing] ▶ **OK** ▶ [High Humidity Mode] ▶ **OK** ▶ [On] ▶ **OK**

\* Specifying [On] may lead to variations in the print density in environments with low humidity.

### Do Ghost Images Appear with Streaks?

If you print on small-sized paper and then continue printing on a larger sized paper, ghost images may appear in the unprinted sections of the paper. In this event, setting [Reduce Ghosting 1] to [On] may improve the print results.

[Home] screen on the control panel ▶ [Menu] ▶ **OK** ▶ [Adjustment/Maintenance] ▶ **OK** ▶ [Adjust Image Quality] ▶ **OK** ▶ [Special Processing] ▶ **OK** ▶ [Reduce Ghosting 1] ▶ **OK** ▶ [On] ▶ **OK**

\* When you select [On], the printing speed may decrease.

## Step 3: Checking the Maintenance Status of the Machine

### Have You Cleaned the Fixing Assembly?

These symptoms may occur when the fixing assembly is dirty. In this case, clean the fixing assembly. ▶ **Cleaning the Fixing Assembly(P. 370)**



# Printouts Are Faded

9664-09A

Troubleshoot by checking the following steps:

- ▶ **Step 1: Checking the Paper and Toner Cartridge(P. 409)**
- ▶ **Step 2: Checking the Usage Environment of the Machine(P. 409)**

## Step 1: Checking the Paper and Toner Cartridge

### Are You Using Appropriate Paper?

- Check whether the paper in the machine is usable, and replace it with appropriate paper, as needed.
  - ▶ **Usable Paper(P. 18)**
  - ▶ **Loading Paper(P. 104)**
- Set the paper size and type correctly according to the loaded paper. ▶ **Specifying the Paper Size and Type(P. 119)**

### Is Printing Faded When Printing Envelopes?

When printing on envelopes with a rough surface, setting [Rough Surface Envelope Mode] to [On] may solve the problem.

[Home] screen on the control panel ▶ [Menu] ▶ **OK** ▶ [Adjustment/Maintenance] ▶ **OK** ▶ [Adjust Image Quality] ▶ **OK** ▶ [Special Processing] ▶ **OK** ▶ [Special Paper Processing] ▶ **OK** ▶ [Rough Surface Envelope Mode] ▶ **OK** ▶ [On] ▶ **OK**

- \* This setting is only available when the paper type is set to [Envelope 2].
- \* Specifying [On] decreases the printing speed.
- \* Specifying [On] disables the [Paper Curl Correction] setting.

### Have the Toner Cartridge Reached the End of Their Lifetime?

Parts inside the toner cartridge may have deteriorated. If this symptom occurs, it is recommended to replace the toner cartridge regardless of the remaining amount of toner or messages displayed. ▶ **Replacing the Toner Cartridge(P. 372)**

- \* Depending on the usage condition of the machine, the actual remaining amount of toner may be lower than indicated or the parts may be deteriorated. If the problem persists, replace the toner cartridge.

## Step 2: Checking the Usage Environment of the Machine

### Are You Using the Machine in an Environment with Sudden Temperature Changes?

Sudden temperature changes can create condensation, which can result in faded or blurry images and text. Setting [Control Condensation] to [On] may solve the problem.

[Home] screen on the control panel ▶ [Menu] ▶ **OK** ▶ [Adjustment/Maintenance] ▶ **OK** ▶ [Maintenance] ▶ **OK** ▶ [Control Condensation] ▶ **OK** ▶ [On] ▶ **OK**

- \* During condensation removal, a blank sheet of paper may be output without being printed correctly. If you set this to [On], you can set whether to restrict printing.
- \* If you set this to [On], you must keep the machine ON to continuously remove the condensation. The automatic shutdown setting is disabled.

## Is the Machine Installed in a Location Subject to Strong Wind Such as from an Air Conditioner?

---

If so, adjust the air direction and volume of the air conditioner.

If that does not work, setting [Switch Paper Feed Method] to [Print Side Priority] may improve the problem.

[Home] on the control panel ▶ [Menu] ▶  ▶ [Function Settings] ▶  ▶ [Common] ▶  ▶ [Paper Feed Settings] ▶  ▶ [Switch Paper Feed Method] ▶  ▶ [Print Side Priority] ▶ 

\* When you select [Print Side Priority], the printing speed for 1-Sided printing will decrease.

# The Edge of the Page Is Not Printed

---

9664-09C

Troubleshoot by checking in the following order:

## Are You Using Appropriate Paper?

---

Check whether the paper in the machine is usable, and replace it with appropriate paper, as needed.

▶ **Usable Paper(P. 18)**

▶ **Loading Paper(P. 104)**

## Are the Paper Guides Correctly Aligned with the Paper?

---

Paper guides that are aligned but too loose or too tight can cause part of the page to not be printed. Check the paper guides, and align them with the width of the paper. ▶ **Loading Paper(P. 104)**

## Are You Printing to the Edge of the Paper Without Margins?

---

This symptom may occur when the margin is set to none in the printer driver. To print with this machine, a margin of 5 mm (10 mm at the top and bottom of an envelope) is required.

On the [Printing preferences] screen of the printer driver, configure the following setting to provide a margin.

[Finishing] tab ▶ [Advanced Settings] ▶ [Expand Print Region and Print] ▶ [Off]

# The Background Is Generally Dark

---

9664-09E

Troubleshoot by checking in the following order:

## Are You Using the Machine in an Appropriate Environment?

---

- Re-install the machine in an appropriate environment.
  - ▶ **Moving the Machine(P. 384)**
- Keep the toner cartridge in a suitable location and try printing again after 2-3 hours. If the problem persists, replace the toner cartridge.
  - ▶ **Replacing the Toner Cartridge(P. 372)**

# White Spots Appear

9664-09F

Troubleshoot by checking the following steps:

- ▶ **Step 1: Checking the Paper(P. 413)**
- ▶ **Step 2: Checking the Toner Cartridge(P. 413)**
- ▶ **Step 3: Checking the Occurrence of White Spots(P. 413)**
- ▶ **Step 4: Checking the Usage Environment of the Machine(P. 413)**

## Step 1: Checking the Paper

### Are You Using Appropriate Paper?

Check whether the paper in the machine is usable, and replace it with appropriate paper, as needed.

- ▶ **Usable Paper(P. 18)**
- ▶ **Loading Paper(P. 104)**

### Are You Using Paper That Has Absorbed Moisture?

Check the precautions, and replace the paper with dry paper.

- ▶ **Precautions When Handling Paper(P. 22)**
- ▶ **Loading Paper(P. 104)**

## Step 2: Checking the Toner Cartridge

### Check the Remaining Amount of Toner in the Toner Cartridge.

Check the remaining amount of toner in the toner cartridge and replace the cartridge that are low on toner.

- ▶ **Checking the Remaining Amount of Consumables(P. 377)**
- ▶ **Replacing the Toner Cartridge(P. 372)**

\* Depending on the usage condition of the machine, the actual remaining amount of toner may be lower than indicated or the parts may be deteriorated. If the problem persists, replace the toner cartridge.

## Step 3: Checking the Occurrence of White Spots

### Are Dark Characters and Lines Hollowed Out?

Setting [High Humidity Mode] to [On] may solve the problem.

[Home] screen on the control panel ▶ [Menu] ▶ **OK** ▶ [Adjustment/Maintenance] ▶ **OK** ▶ [Adjust Image Quality] ▶ **OK** ▶ [Special Processing] ▶ **OK** ▶ [High Humidity Mode] ▶ **OK** ▶ [On] ▶ **OK**

\* Specifying [On] may lead to variations in the print density in environments with low humidity.

## Step 4: Checking the Usage Environment of the Machine

### Are You Using the Machine in an Environment with Sudden Temperature Changes?

Sudden temperature changes can create condensation, which can result in faded or blurry images and text. Setting [Control Condensation] to [On] may solve the problem.

[Home] screen on the control panel ▶ [Menu] ▶ **OK** ▶ [Adjustment/Maintenance] ▶ **OK** ▶  
 [Maintenance] ▶ **OK** ▶ [Control Condensation] ▶ **OK** ▶ [On] ▶ **OK**

\* During condensation removal, a blank sheet of paper may be output without being printed correctly. If you set this to [On], you can set whether to restrict printing.

\* If you set this to [On], you must keep the machine ON to continuously remove the condensation. The automatic shutdown setting is disabled.

### Are You Using the Machine in a Humid Environment?

---

Setting [High Humidity Mode] to [On] may solve the problem.

[Home] screen on the control panel ▶ [Menu] ▶ **OK** ▶ [Adjustment/Maintenance] ▶ **OK** ▶ [Adjust Image  
 Quality] ▶ **OK** ▶ [Special Processing] ▶ **OK** ▶ [High Humidity Mode] ▶ **OK** ▶ [On] ▶ **OK**

\* Specifying [On] may lead to variations in the print density in environments with low humidity.

## Smudge Marks Appear on the Back Side of Printouts

---

9664-0CL

Troubleshoot by checking in the following order:

### Are You Using Paper That Is Smaller Than the Size of the Print Data?

---

Replace with paper that is the same size as the print data. ▶ **Loading Paper(P. 104)**

### Does staining occur when you print photos or other halftone images on small-sized heavy paper?

---

Setting [Rdc. Tnr Flaking from Heavy Sml. Ppr] to [On] may solve the problem.

[Home] screen on the control panel ▶ **OK** ▶ [Menu] ▶ **OK** ▶ [Adjustment/Maintenance] ▶ **OK** ▶ [Adjust Image Quality] ▶ **OK** ▶ [Special Processing] ▶ **OK** ▶ [Special Paper Processing] ▶ **OK** ▶ [Rdc. Tnr Flaking from Heavy Sml. Ppr] ▶ **OK** ▶ [On] ▶ **OK**

\* Specifying [On] may make printing slower.

### Have You Cleaned the Fixing Assembly?

---

These symptoms may occur when the fixing assembly is dirty. In this case, clean the fixing assembly. ▶ **Cleaning the Fixing Assembly(P. 370)**

## Printouts Are Skewed

9664-09J

This symptom may occur when the paper guides are aligned but too loose or too tight. Check the paper guides, and align them with the width of the paper. **▶ Loading Paper (P. 104)**

**Paper Drawer**

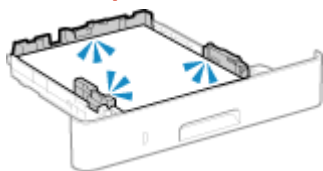

**Multi-purpose Tray**





# The Printed Barcode Cannot be Scanned

---

9664-OCR

Troubleshoot by checking in the following order:

## Are You Using a Very Small Barcode or One With Thick Lines?

---

- Enlarge the barcode.
- If the barcode lines are perpendicular to the output feed direction, rotate the image 90° so that the lines are parallel.

## Try using Barcode Adjustment Mode

---

Setting [Barcode Adjustment Mode] to [Mode 1] in the printer driver may solve the problem. If that does not work, try selecting [Mode 2] and then [Mode 3] in sequence.

- Specify the settings below in the [Printing preferences] screen of the printer driver.

[Finishing] tab ▶ [Advanced Settings] ▶ [Barcode Adjustment Mode] ▶ select the mode

\* When this setting is enabled, the print density may decrease.

- If setting [Barcode Adjustment Mode] to [Mode 3] does not work, changing the [Printer Density] may solve the problem. ▶ **Adjusting the Print Density(P. 381)**

## Paper and Paper Feeding Problems

---

9664-09K

Check how to troubleshoot the problem based on the symptom.

- ▶ **Paper Creases(P. 419)**
- ▶ **Paper Curls(P. 420)**
- ▶ **Paper Is Not Fed or Two or More Sheets Are Fed Together(P. 421)**

# Paper Creases

9664-OCS

Troubleshoot by checking the items below.

## Is Paper Loaded Correctly?

- Make sure the loaded paper does not exceed the load limit line or load limit guide ( a ).

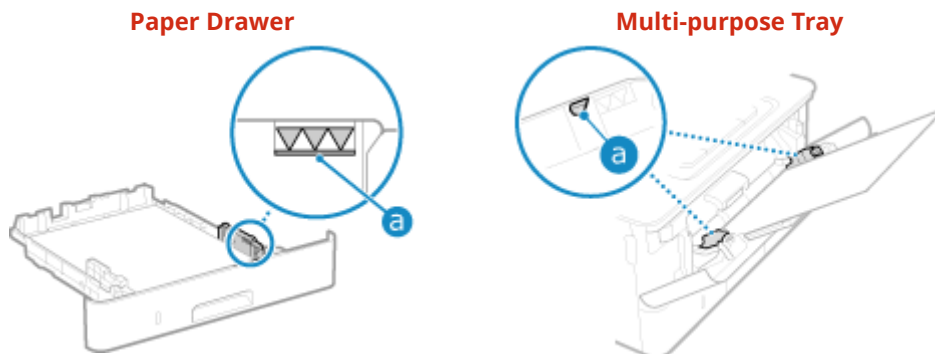

- Check that the paper guides are aligned with the markings and are not too loose or too tight.

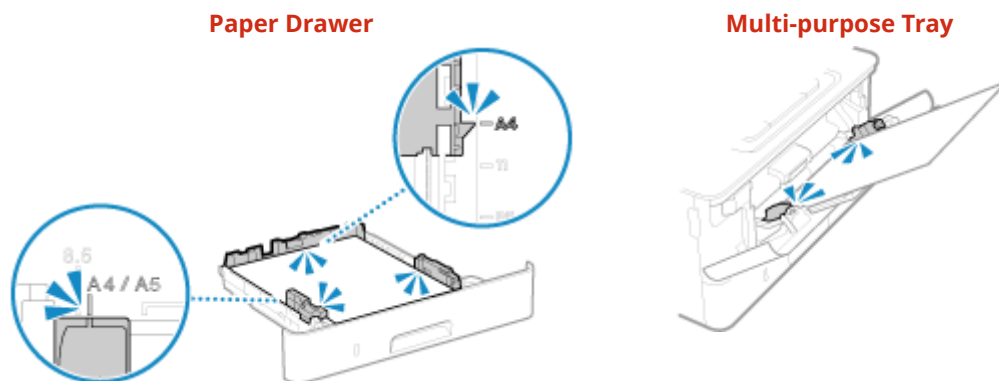

## Are You Using Paper That Has Absorbed Moisture?

Check the precautions, and replace the paper with dry paper.

- **Precautions When Handling Paper(P. 22)**
- **Loading Paper(P. 104)**

## Are You Using Appropriate Paper?

Check whether the paper in the machine is usable, and replace it with appropriate paper, as needed.

- **Usable Paper(P. 18)**
- **Loading Paper(P. 104)**

## Does This Occur When Printing on Plain Paper or Thin Paper?

Setting [Paper Wrinkle Correction] to [On] may solve the problem.

```
[Home] screen on the control panel ▶ OK ▶ [Menu] ▶ OK ▶ [Adjustment/Maintenance] ▶ OK ▶ [Adjust Image Quality] ▶ OK ▶ [Special Processing] ▶ OK ▶ [Special Paper Processing] ▶ OK ▶ [Paper Wrinkle Correction] ▶ OK ▶ [On] ▶ OK
```

Specifying [On] may lead to faded printouts or slower printing speeds.

# Paper Curls

9664-09R

Troubleshoot by checking the items below.

## Are You Using Appropriate Paper?

- Check whether the paper in the machine is usable, and replace it with appropriate paper, as needed.
  - ▶ **Usable Paper(P. 18)**
  - ▶ **Loading Paper(P. 104)**
- Set the paper size and type correctly according to the loaded paper. ▶ **Specifying the Paper Size and Type(P. 119)**
- Setting [Paper Curl Correction] to [On] may improve the problem.

[Home] screen on the control panel ▶ [Menu] ▶ **OK** ▶ [Adjustment/Maintenance] ▶ **OK** ▶ [Adjust Image Quality] ▶ **OK** ▶ [Special Processing] ▶ **OK** ▶ [Special Paper Processing] ▶ **OK** ▶ [Paper Curl Correction] ▶ **OK** ▶ [On] ▶ **OK**

\* When you select [On], this may result in faded printouts and slower printing speeds.

- Setting [Switch Paper Feed Method] to [Print Side Priority] may improve the problem.

[Home] on the control panel ▶ [Menu] ▶ **OK** ▶ [Function Settings] ▶ **OK** ▶ [Common] ▶ **OK** ▶ [Paper Feed Settings] ▶ **OK** ▶ [Switch Paper Feed Method] ▶ **OK** ▶ [Print Side Priority] ▶ **OK**

\* When you select [Print Side Priority], the printing speed for 1-Sided printing will decrease.

- Load the paper with the side to be printed (paper front and back) reversed.
  - \* In rare cases, the symptom may worsen depending on the paper used. In this case, print on the original side of the paper.

## Are You Using Paper That Has Absorbed Moisture?

Try the following in the order below:

- Check the precautions, and replace the paper with dry paper.
  - ▶ **Precautions When Handling Paper(P. 22)**
  - ▶ **Loading Paper(P. 104)**
- Change the paper type setting to a thinner paper. ▶ **Specifying the Paper Size and Type(P. 119)**

# Paper Is Not Fed or Two or More Sheets Are Fed Together

---

9664-09S

Troubleshoot by checking the items below.

## Are You Using Appropriate Paper?

---

Check whether the paper in the machine is usable, and replace it with appropriate paper, as needed.

- ▶ **Usable Paper(P. 18)**
- ▶ **Loading Paper(P. 104)**

## Is Paper Loaded Correctly?

---

- Fan the paper thoroughly in small batches so that it is not stuck together.
- Align the edges by tapping the paper on a flat surface a few times before loading the paper. ▶ **Loading Paper(P. 104)**
- Do not load paper of different sizes or types together.

# Setting Up

---

9664-09W

This is a list of problems that can occur during setup of the machine. Check how to troubleshoot the problem based on the symptom.

## ■ Problems During Driver Installation

### ▶ **The Machine Connected via WSD Port Is Not Displayed During Driver Installation(P. 423)**

## ■ Problems with Wireless LAN and Wired LAN Connection

### **Cannot Connect to Wireless LAN**

Check whether the machine can connect to the network.

#### ▶ **Cannot Connect to Wireless LAN(P. 424)**

### **Cannot Connect to Wired LAN**

The IP address setting may have failed. Set the IP address again.

#### ▶ **Setting IPv4 Addresses(P. 58)**

#### ▶ **Setting IPv6 Addresses(P. 60)**

### **Cannot Connect to Wireless LAN and Wired LAN at the Same Time**

You cannot connect the machine to a wireless LAN and wired LAN at the same time. You can connect to USB and wireless LAN or USB and wired LAN at the same time.

## ■ Problems with USB Connection

### **The Computer Cannot Communicate with the Machine**

Try the following:

- Replace the USB cable. If the USB cable is long, replace it with a short cable.
- If you are using a USB hub, connect the machine directly to the computer using a USB cable.

# The Machine Connected via WSD Port Is Not Displayed During Driver Installation

9664-09X

Troubleshoot by checking the items below.

## Check the Settings of the Machine.

Configure the settings below if they have not been configured. The machine must be restarted to apply the settings.

### WSD Printing and Multicast Discovery Settings

Log in to Remote UI in System Manager Mode ▶ [Settings/Registration] ▶ [Network Settings] ▶ [WSD Settings] ▶ [Edit] ▶ select the [Use WSD Printing] and [Use Multicast Discovery] checkboxes ▶ [OK] ▶ restart the machine.

On the control panel, select [Menu] in the [Home] screen, and then select [Preferences] to configure the settings. ▶ **[WSD Settings](P. 299)**

### Selecting the Page Description Language

Select the page description language (PDL) of the installed driver.

Log in to Remote UI in System Manager Mode ▶ [Settings/Registration] ▶ [Printer Settings] ▶ [PDL Selection (Plug and Play)] ▶ [Edit] ▶ select the PDL in [Network] ▶ [OK] ▶ restart the machine.

On the control panel, select [Menu] in the [Home] screen, and then select [Function Settings] to configure the settings. ▶ **[Network](P. 339)**

## Check the OS Network Settings.

Configure the settings below if they have not been configured.

In Windows, click [Start] (Start) ▶ [Settings] (Settings) ▶ [Network & Internet] ▶ [Status] ▶ [Change connection properties] ▶ [Network profile] ▶ [Private]

## Check Whether the Driver Is Installed.

Use the following procedure to check whether the driver of the machine is displayed.

In Windows, click [Start] (Start) ▶ [Settings] (Settings) ▶ [Devices] ▶ [Printers & scanners] ▶ check whether the driver is displayed.

If the driver is displayed, it is installed. In this case, uninstall the driver, and then reinstall it. For details about uninstalling and installing drivers, see the driver manual at the online manual site. <https://oip.manual.canon/>

# Cannot Connect to Wireless LAN

9664-09Y

Troubleshoot by checking the status of the computer, wireless LAN router (access point), and machine with the steps below.

- ▶ **Step 1: Checking the Status of the Computer and Wireless LAN Router(P. 424)**
- ▶ **Step 2: Checking the Status of the Machine and Wireless LAN Router(P. 424)**
- ▶ **Step 3: Reconnecting to a Wireless LAN(P. 424)**

## Step 1: Checking the Status of the Computer and Wireless LAN Router

### Have You Configured the Settings of the Computer and Wireless LAN Router?

Configure the required settings if they have not been configured.

### Are the Power Cables and Ethernet Cable Connected Correctly?

If any cables are connected incorrectly or disconnected, connect them correctly.

### Is the Power of Wireless LAN Router On?

If you cannot establish a connection even if the power is on, turn off the power of the computer and router and turn it on again.

## Step 2: Checking the Status of the Machine and Wireless LAN Router

### Is the Power of the Machine ON?

If the power is ON, turn OFF the power and turn it ON again.

### Is the Location Appropriate?

- The machine and wireless LAN router should be installed in a location without walls or other obstructions between the devices and within range of 50 m.
- Do not install near a microwave oven, cordless telephone, or other device that generates radio waves.

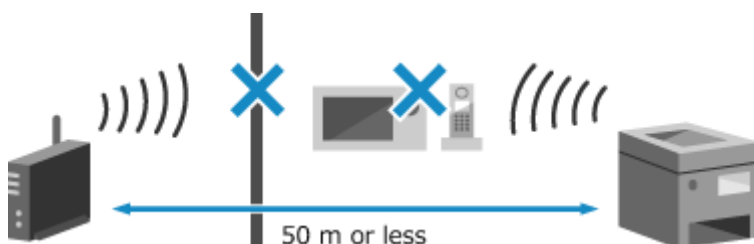

## Step 3: Reconnecting to a Wireless LAN

Connect to the wireless LAN using the connection type according to your wireless LAN router. ▶ **Connecting to a Wireless LAN(P. 47)**



# Network

---

9664-0A0

This is a list of problems that can occur with the network. Check how to troubleshoot the problem based on the symptom.

- ▶ **Cannot Switch to Wireless LAN(P. 426)**
- ▶ **Cannot Find the Print Server to Connect to(P. 427)**
- ▶ **Cannot Connect to a Shared Printer(P. 428)**
- ▶ **Cannot Find the IP Address of the Machine(P. 429)**
- ▶ **AirPrint Does Not Work(P. 430)**

## Cannot Switch to Wireless LAN

---

9664-0A1

Use the network settings to switch from wired LAN connection to wireless LAN connection.

### 1 On the control panel, select [Menu] in the [Home] screen, and press **OK**. **▶**[Home] Screen(P. 94)

Press [Preferences] **▶** **OK** **▶** [Network] **▶** **OK** [Select Wired/Wireless LAN] **▶** **OK**.

⇒ The [Select Wired/Wireless LAN] screen is displayed.

If the login screen appears, enter the System Manager ID and PIN, and then press **ID**. **▶**System Manager ID and PIN(P. 6)

### 3 Press [Wireless LAN].

⇒ The message [Settings applied.] appears.

### 4 Connect the machine to the wireless LAN. **▶**Connecting to a Wireless LAN(P. 47)

### 5 Install the driver to the computer that will use the machine.

When switching the machine from wired LAN connection to wireless LAN connection, any installed drivers must be uninstalled and then reinstalled.

For details about uninstalling and installing drivers, see the driver manual at the online manual site.  
<https://oip.manual.canon/>

# Cannot Find the Print Server to Connect to

---

9664-0A2

Troubleshoot by checking the items below.

## **Are the Print Server and Computer Connected Correctly?**

---

- Check the network settings of the print server and computer, and make sure they are connected correctly.
- If they are connected using an Ethernet cable, make sure the cable is connected correctly.

## **Is the Print Server Started?**

---

Start the print server if it has not been started.

## **Are there Any Restrictions with Connecting to the Print Server?**

---

Check with the administrator of the print server, and ask for permission, if needed.

## **Is Network Discovery Enabled? (Windows)**

---

Enable network discovery if not enabled. [▶ Enabling Network Discovery\(P. 472\)](#)

## Cannot Connect to a Shared Printer

---

9664-0A3

Check if a shared printer is displayed on the network computer. ▶ **Displaying a Shared Printer in the Print Server(P. 472)**



If it is not displayed, contact the network or print server administrator.

## Cannot Find the IP Address of the Machine



9664-0A4

View the IP address using the following procedure:

### Viewing the IPv4 Address

 on the control panel ► [Network Information] ►  ► [IPv4] ►  ► view the setting.

### Viewing the IPv6 Address

 on the control panel ► [Network Information] ►  ► [IPv6] ►  ► view the setting.

## NOTE

### If the IP Address Is Displayed as "0.0.0.0"

- A suitable IP address is not set. Set the IP address again.
  - ▶ [Setting IPv4 Addresses\(P. 58\)](#)
  - ▶ [Setting IPv6 Addresses\(P. 60\)](#)

# AirPrint Does Not Work

---

9664-0A5

Troubleshoot by checking the items below.

## Is the Power of the Machine ON?

---

If the machine is ON, restart the machine, and try AirPrint again. [▶Restarting the Machine\(P. 87\)](#)

## Does an Error Message Appear on the control panel?

---

Follow the instructions of the error message on the screen to fix the problem. [▶A Message Appears\(P. 445\)](#)

## When Using a Mac, Is it Correctly Connected to the Machine?

---

Connect the Mac to the network on the same LAN as the machine. [▶Setting Up the Network\(P. 43\)](#)  
When connecting via USB, directly connect the Mac to the USB port for computer connection on the back of the machine with a USB cable. [▶Rear Side\(P. 12\)](#)

## Are You Required to Enter the Department ID and PIN to Print from a Computer? (When Using Department ID Management on the Machine)

---

If you are required to enter a Department ID and PIN to print from a computer, the machine blocks printing from an unknown Department ID, so AirPrint cannot be used. To enable use of AirPrint, cancel blocking of printing when the Department ID is unknown. [▶Enabling Department ID Management\(P. 198\)](#)

## Have the Functions Usable with AirPrint Been Restricted?

---

If the protocol (IPP or Network Link Scan) for use with AirPrint has been disabled to restrict functions, cancel this restriction to enable the use of AirPrint. [▶Setting the Functions and Security to Be Used with AirPrint\(P. 176\)](#)

## Is Bonjour Enabled on Your Apple Device?

---

Enable Bonjour if it is not enabled. For details, see the manual of your Apple device.

# Printing

---

9664-0A6

This is a list of problems that can occur when printing. Check how to troubleshoot the problem based on the symptom.

- ▶ **Cannot Print(P. 432)**
- ▶ **Printing Is Slow(P. 438)**

## ■ Problems with Printing Results

If the printing results are not as expected, see the following:

- ▶ **Problems with Printing Results(P. 399)**

## ■ Frequently Asked Questions about Operations

### **I Want to Print on an Envelope.**

Place the envelope in the multi-purpose tray while paying attention to the orientation and side of the envelope.

Then, set the paper size and type according to the placed envelope.

Next, use the printer driver of the computer to set the paper size of the document and the paper size to print, and then perform printing.

- ▶ **Preparations and Orientation for Loading Envelopes(P. 113)**
- ▶ **Specifying the Paper Size and Type(P. 119)**
- ▶ **Printing from a Computer(P. 154)**

# Cannot Print

---

9664-0A7

Troubleshoot by checking the items below.

## Has an Error Occurred?

---

Check the print processing status and log, and if a three-digit number starting with "#" (error code) is displayed, check how to troubleshoot the problem based on the error code.

- ▶ **Viewing the Print Job Status and Log(P. 169)**
- ▶ **An Error Code Is Displayed(P. 458)**

## Can You Print a Test Page?

---

If you can print a test page, check if the print settings of the application are correct.

- ▶ **Printing a Test Page(P. 478)**

## Check the Network Status and Settings.

---

Check the required items according to the usage environment.

- ▶ **Cannot Print (Wireless LAN)(P. 433)**
- ▶ **Cannot Print (Wired LAN)(P. 435)**
- ▶ **Cannot Print (USB Connection)(P. 436)**
- ▶ **Cannot Print (via Print Server)(P. 437)**



# Cannot Print (Wireless LAN)

9664-0A8

Troubleshoot by checking the items below.

## Check the Wireless LAN Connection Status.

Check the connection status of the machine, and take action according to the status. [▶Viewing the MAC Address and Connection Information of the Wireless LAN\(P. 78\)](#)

### If the Machine Is Not Connected to the Wireless LAN

Check the status of the computer and wireless LAN router (access point) and the status of the machine, and reconnect to the wireless LAN. [▶Cannot Connect to Wireless LAN\(P. 424\)](#)

### If the Connection Is Poor

Change the following settings on the wireless LAN router, and try printing:

- Change the channel of the wireless LAN router. If there are multiple wireless LAN routers, separate the channels by five or more channels.
- Increase the wireless output of the wireless LAN router if possible.

## Are the Machine and Computer Connected to the Same Wireless LAN Router?

- When you are using a computer connected to a wireless LAN, check that the SSID (identifier of the wireless LAN router) of the machine matches that of the computer.
  - ▶[Viewing the MAC Address and Connection Information of the Wireless LAN\(P. 78\)](#)
  - ▶[Viewing the Network Connection Information of the Computer\(P. 475\)](#)
- If the SSID of the machine and the computer do not match, configure the wireless LAN connection settings on the machine again, and connect the machine to the SSID to which the computer is connected. [▶Connecting to a Wireless LAN\(P. 47\)](#)

## Is the Printer Port of the Computer Configured Correctly? (Windows)

Change the settings if they have not been configured correctly. If there is no available port, add a new port.

- ▶[Viewing the Printer Port\(P. 477\)](#)
- ▶[Configuring a Printer Port \(Windows\)\(P. 141\)](#)

## Can You Access Remote UI?

If you cannot access Remote UI, the firewall settings of the machine may be incorrect, preventing communication with the computer.

Use the following procedure to disable the firewall settings with the control panel, and then use Remote UI to configure the firewall again.

Administrator privileges are required. The machine must be restarted to apply the settings.

- 1 Disable the firewall settings.

### To Disable IPv4 Address Filter

[Home] screen on the control panel ▶ [Menu] ▶ **OK** ▶ [Preferences] ▶ **OK** ▶ [Network] ▶ **OK** ▶ [Firewall Settings] ▶ **OK** ▶ [IPv4 Address Filter] ▶ **OK** ▶ [Outbound Filter] or [Inbound Filter] ▶ **OK** ▶ [Off] ▶ **OK** ▶ Restart the machine.

### To Disable IPv6 Address Filter

[Home] screen on the control panel ▶ [Menu] ▶ **OK** ▶ [Preferences] ▶ **OK** ▶ [Network] ▶ **OK** ▶ [Firewall Settings] ▶ **OK** ▶ [IPv6 Address Filter] ▶ **OK** ▶ [Outbound Filter] or [Inbound Filter] ▶ **OK** ▶ [Off] ▶ **OK** ▶ Restart the machine.

### To Disable MAC Address Filter

[Home] screen on the control panel ▶ [Menu] ▶ **OK** ▶ [Preferences] ▶ **OK** ▶ [Network] ▶ **OK**  
 ▶ [Firewall Settings] ▶ **OK** ▶ [MAC Address Filter] ▶ **OK** ▶ [Outbound Filter] or [Inbound Filter] ▶ **OK** ▶  
 [Off] ▶ **OK** ▶ Restart the machine.

- 2 Configure the firewall correctly. ▶ **Setting the Firewall(P. 203)**

### Reinstall the Printer Driver.

---

Uninstall the installed driver, and then reinstall it.

For details about uninstalling and installing drivers, see the driver manual at the online manual site.

<https://oip.manual.canon/>

### Are You Using Resident Software?

---

If you are using resident software, such as security software, disable it and then try printing.

### Can You Print from Another Computer in the Network?

---

If you cannot print from another computer, contact your dealer or service representative. ▶ **If the Problem Persists(P. 463)**

# Cannot Print (Wired LAN)

9664-0A9

Troubleshoot by checking the items below.

## Is the Printer Port of the Computer Configured Correctly? (Windows)

Change the settings if they have not been configured correctly. If there is no available port, add a new port.

- ▶ **Viewing the Printer Port(P. 477)**
- ▶ **Configuring a Printer Port (Windows)(P. 141)**

## Can You Access Remote UI?

If you cannot access Remote UI, the firewall settings of the machine may be incorrect, preventing communication with the computer.

Use the following procedure to disable the firewall settings with the control panel, and then use Remote UI to configure the firewall again.

Administrator privileges are required. The machine must be restarted to apply the settings.

- 1 Disable the firewall settings.

### To Disable IPv4 Address Filter

[Home] screen on the control panel ▶ [Menu] ▶ **OK** ▶ [Preferences] ▶ **OK** ▶ [Network] ▶ **OK**  
 ▶ [Firewall Settings] ▶ **OK** ▶ [IPv4 Address Filter] ▶ **OK** ▶ [Outbound Filter] or [Inbound Filter] ▶ **OK** ▶  
 [Off] ▶ **OK** ▶ Restart the machine.

### To Disable IPv6 Address Filter

[Home] screen on the control panel ▶ [Menu] ▶ **OK** ▶ [Preferences] ▶ **OK** ▶ [Network] ▶ **OK**  
 ▶ [Firewall Settings] ▶ **OK** ▶ [IPv6 Address Filter] ▶ **OK** ▶ [Outbound Filter] or [Inbound Filter] ▶ **OK** ▶  
 [Off] ▶ **OK** ▶ Restart the machine.

### To Disable MAC Address Filter

[Home] screen on the control panel ▶ [Menu] ▶ **OK** ▶ [Preferences] ▶ **OK** ▶ [Network] ▶ **OK**  
 ▶ [Firewall Settings] ▶ **OK** ▶ [MAC Address Filter] ▶ **OK** ▶ [Outbound Filter] or [Inbound Filter] ▶ **OK** ▶  
 [Off] ▶ **OK** ▶ Restart the machine.

- 2 Configure the firewall correctly. ▶ **Setting the Firewall(P. 203)**

## Reinstalling the Printer Driver

Uninstall the installed driver, and then reinstall it.

For details about uninstalling and installing drivers, see the driver manual at the online manual site.

**https://oip.manual.canon/**

## Are You Using Resident Software?

If you are using resident software, such as security software, disable it and then try printing.

## Can You Print from Another Computer in the Network?

If you cannot print from another computer, contact your dealer or service representative. ▶ **If the Problem Persists(P. 463)**

## Cannot Print (USB Connection)

---

9664-0AA

Troubleshoot by checking the items below.

### Check the USB Cable.

---

- If you are using a long USB cable, replace it with a short USB cable.
- If you still cannot print with a short USB cable, the cable may be damaged. Replace with a new USB cable, and try printing.

### Are You Using a USB Hub?

---

Connect the machine directly to the computer using a USB cable.

### Try Using Another USB Port.

---

Connect the USB cable to another USB port on your computer.

### Is the Printer Port of the Computer Configured Correctly? (Windows)

---

If the printer port is not configured correctly or there is no available port, reinstall the printer driver. When you reinstall the driver, the correct port is configured automatically. ▶ **Viewing the Printer Port(P. 477)**  
For details about installing the driver, see the manual of the driver at the online manual site.  
<https://oip.manual.canon/>

### Is Two-way Communication Between the Machine and Computer Enabled? (Windows)

---

Enable two-way communication if it is not enabled, and restart the computer and machine. ▶ **Viewing Two-way Communication(P. 478)**

### Is a Setting Preventing the Machine from Establishing a USB Connection to the Computer?

---

If usage of the USB port for computer connection on the back of the machine is restricted, cancel this setting. ▶ **Preventing Connection to Computer via USB Port(P. 241)**

### Are You Using Resident Software?

---

If you are using resident software, such as security software, disable it and then try printing.

### Can You Print via USB Connection from Another Computer?

---

If you cannot print from another computer, contact your dealer or service representative. ▶ **If the Problem Persists(P. 463)**

## Cannot Print (via Print Server)

---

9664-0AC

Troubleshoot by checking the items below.

### Can You Print from the Print Server?

---

If you can print, check the connection between the computer and the print server. ▶ **Cannot Find the Print Server to Connect to(P. 427)**

### Reinstall the Printer Driver.

---

Uninstall the installed driver, and then reinstall it.

For details about uninstalling and installing drivers, see the driver manual at the online manual site.

**<https://oip.manual.canon/>**

#### Installing in Windows

Use a print server to install the printer driver.

Double-click the shared printer on the print server, and follow the instructions on the screen to install the printer driver. ▶ **Displaying a Shared Printer in the Print Server(P. 472)**

### Are You Using Resident Software?

---

If you are using resident software, such as security software, disable it and then try printing.

### Can You Print via a Print Server from Another Computer?

---

If you cannot print from another computer, contact your dealer or service representative. ▶ **If the Problem Persists(P. 463)**

## Printing Is Slow

---

9664-0AE

It takes time until the first page is printed. The printing speed may be slower after continuous printing or printing on narrow paper to allow for adjustments of the temperature or image quality of the machine.

In all other cases, an error may have occurred. Troubleshoot by checking the items below.

### Check the Paper Orientation.

---

This symptom may occur depending on the paper orientation. Change the paper orientation if possible. ▶  
**Loading Paper(P. 104)**

### Is Secure Print Enabled?

---

This symptom may occur when Secure Print is enabled. Use the procedure below to disable Secure Print. The machine must be restarted to apply the settings.

Log in to Remote UI in System Manager Mode ▶ [Settings/Registration] ▶ [Secure Print Settings] ▶ [Edit] ▶ clear the [Secure Print] checkbox ▶ [OK] ▶ restart the machine.

On the control panel, select [Menu] in the [Home] screen, and then select [Function Settings] to configure the settings. ▶**[Secure Print](P. 316)**

# Management Functions and Environment Settings

---

9664-0AF

This is a list of frequently asked questions about management functions. Check the applicable item.

- ▶ **Cannot Access Remote UI(P. 440)**
- ▶ **Changing the Volume of the Confirmation Sound and Warning Tone(P. 441)**
- ▶ **Changing the Time Until Sleep Mode(P. 442)**
- ▶ **Lost Department ID or PIN for the Administrator(P. 443)**
- ▶ **Checking the Items That Can Be Configured on the Machine and Their Settings(P. 444)**

# Cannot Access Remote UI

9664-0AH

If the message [Cannot access Remote UI.] or [Cannot continue the settings because the function to perform settings for the device is restricted.] appears and you cannot access Remote UI, troubleshoot by checking the items below.

## Set the Remote UI Access PIN.

To access the Remote UI, you must set the Remote UI Access PIN.

Administrator privileges are required to configure the setting.

[Home] screen on the control panel ▶ [Menu] ▶ **OK** ▶ [Management Settings] ▶ **OK** ▶ [Remote UI Settings/ Update Firmware] ▶ **OK** ▶ [Remote UI Settings] ▶ **OK** ▶ [Remote UI Access Security Settings] ▶ **OK** ▶ [On] ▶ **OK** ▶ enter the PIN ▶ **OK** ▶ enter the PIN again ▶ **OK**

- \* You cannot set a PIN consisting of all zeros, such as "00" or "0000000."
- \* A Remote UI PIN is not required when Department ID Management is enabled.

## Change the System Manager PIN.

When logging in with System Manager Mode, you must change the System Manager PIN from the default settings.

Administrator privileges are required to change the settings.

[Home] screen on the control panel ▶ [Menu] ▶ **OK** ▶ [Management Settings] ▶ **OK** ▶ [User Management] ▶ **OK** ▶ [System Manager Information Settings] ▶ **OK** ▶ [System Manager ID and PIN] ▶ **OK** ▶ enter the System Manager ID ▶ **OK** ▶ enter the PIN ▶ **OK** ▶ enter the PIN again ▶ **OK**

- \* You cannot set a System Manager ID or PIN consisting of all zeros, such as "00" or "0000000."
- \* Only allow certain administrators to have access to the System Manager ID and PIN after the settings are changed.



# Changing the Volume of the Confirmation Sound and Warning Tone

---

9664-0AJ

You can change the volume of the confirmation sound and warning tone according to the usage environment of the machine.

▶ **Adjusting the Volume(P. 132)**

## Changing the Time Until Sleep Mode

---

9664-0AK

In addition to being able to change the time until the machine enters sleep mode, you can also configure a specified time the machine enters sleep mode.

➤ **Reducing Power Consumption (Sleep Mode)(P. 89)**

## Lost Department ID or PIN for the Administrator

---

9664-0AL

Contact the administrator to check whether the System Manager ID and System Manager PIN were changed from the default settings.

The System Manager ID and System Manager PIN are not set by default.

\* If they have not been changed from the default settings, change them for enhanced security, and allow only certain administrators to know this information. ▶ **Setting the Department ID and PIN for the Administrator(P. 191)**

### NOTE

- If you still cannot recover your System Manager ID and PIN even after confirming the above information, contact your dealer or service representative. ▶ **If the Problem Persists(P. 463)**

# Checking the Items That Can Be Configured on the Machine and Their Settings

---

9664-0AR

You can print the User Data List and System Manager Data List to check the items that can be configured on the machine and their settings.

🔗 **Printing and Viewing Reports and Lists(P. 265)**

**User Data List**

Displays the settings that do not require administrator privileges.

**System Manager Data List**

Displays the settings that require administrator privileges.

## A Message Appears

---

9664-0AS

If a message appears on the control panel, select the message from the list below, and check how to troubleshoot the problem.

- ▶ **Cannot analyze the authentication server certificate.(P. 446)**
- ▶ **Cannot find the access point.(P. 446)**
- ▶ **Cannot print. A non-Canon or counterfeit cartridge may be in use. Close: Press OK(P. 447)**
- ▶ **Cannot print RX data.(P. 447)**
- ▶ **Cartridge communication error. Cannot print. A non-Canon or counterfeit cartridge may be inserted. (P. 447)**
- ▶ **Cart. end of lifetime. Rplcmt. recommended.(P. 447)**
- ▶ **Cartridge Communication Error Problems resulting from the use of non-Canon cartridges are not covered under the warranty.(P. 448)**
- ▶ **Change the authentication password.(P. 448)**
- ▶ **Check the authentication settings.(P. 448)**
- ▶ **Could not connect.(P. 448)**
- ▶ **Could not connect. Check the encryption key.(P. 448)**
- ▶ **Could not connect. Device will restart.(P. 449)**
- ▶ **Could not connect. Max connections to access point reached(P. 449)**
- ▶ **Could not connect using the wireless LAN.(P. 449)**
- ▶ **Could not connect using WPS. Wait a moment, then configure the settings again.(P. 449)**
- ▶ **Could not detect any connections from wireless devices.(P. 450)**
- ▶ **Could not perform cleaning.(P. 450)**
- ▶ **Could not perform IEEE 802.1X authentication. Cannot analyze the authentication server certificate. (P. 450)**
- ▶ **Could not perform IEEE 802.1X authentication. Change the authentication password.(P. 450)**
- ▶ **Could not perform IEEE 802.1X authentication. Check the authentication settings.(P. 450)**
- ▶ **Could not perform IEEE 802.1X authentication. Configure the correct authentication information.(P. 451)**
- ▶ **Could not perform IEEE 802.1X authentication. Configure the information required for authentication. (P. 451)**
- ▶ **Could not perform IEEE 802.1X authentication. No reply from the destination.(P. 451)**
- ▶ **Could not perform IEEE 802.1X authentication. The authentication server certificate has expired.(P. 451)**
- ▶ **Could not perform IEEE 802.1X authentication. The authentication server certificate is incorrect.(P. 451)**
- ▶ **Could not perform Open System auth. Chk encryp. key set.(P. 452)**
- ▶ **Could not perform Shared Key auth. Chk encryp. key set.(P. 452)**
- ▶ **Direct Connection terminated.(P. 452)**
- ▶ **Easy Conn. via PC ended due to timeout Device will restart.(P. 452)**
- ▶ **Encryption key not set correctly. Check encryption key set.(P. 453)**
- ▶ **Key Lock is enabled.(P. 453)**
- ▶ **Low Cartridge Level(P. 453)**
- ▶ **Mem. full. Check error w/Status Monitor key.(P. 453)**
- ▶ **Memory full. Process secure print jobs.(P. 454)**
- ▶ **No Paper(P. 454)**
- ▶ **No reply from the destination.(P. 454)**
- ▶ **No response from the host.(P. 454)**
- ▶ **Paper jammed.(P. 454)**
- ▶ **Prepare a cartridge.(P. 454)**
- ▶ **Printing is restricted.(P. 455)**
- ▶ **Problems caused by non-Canon cart. not covered by warranty. Close: Press OK(P. 455)**
- ▶ **Set the correct authentication information.(P. 455)**
- ▶ **Set the information necessary for authentication.(P. 455)**
- ▶ **Size/Settings Mismatch(P. 456)**

- ▶ The authentication server certificate has expired.(P. 456)
- ▶ The authentication server certificate is incorrect.(P. 456)
- ▶ The encryption key is not set correctly. Check the encryption key settings.(P. 456)
- ▶ The memory is full.(P. 457)
- ▶ The number of entered characters is incorrect or invalid characters are used.(P. 457)
- ▶ Use Remote UI to set the information necessary for authentication.(P. 457)

## NOTE

- If the problem persists even after trying the troubleshooting methods, contact your dealer or service representative. ▶ **If the Problem Persists(P. 463)**

### Cannot analyze the authentication server certificate.

The certificate of the authentication server may not be correct, or it may be a format unsupported by the machine.

**Check the Certificate of the Authentication Server, and Change the Setting, as Needed.**

- ▶ **Setting IEEE 802.1X(P. 215)**

### Cannot find the access point.

An error occurred, preventing the machine from detecting the wireless LAN router (access point).

#### Is Connection Type Configured Correctly?

Select the connection type (WPS) according to the method supported by the wireless LAN router. ▶

**Connecting to a Wireless LAN by Using the Router Button (Push Button Mode)(P. 50)**

#### Did You Connect Within the Fixed Time?

When connecting by pressing a button on the wireless LAN router, set the connection type on the control panel of the machine, and then press the button on the wireless LAN router within one or two minutes. ▶

**Connecting to a Wireless LAN by Using the Router Button (Push Button Mode)(P. 50)**

#### Are the SSID and Network Key Configured Correctly?

When entering the wireless LAN router information manually, check the SSID and network key of the wireless LAN router, and configure the settings correctly on the machine. ▶ **Connecting to a Wireless LAN by Setting the Details (Manual Setup Method)(P. 55)**

#### Are the Machine and Wireless LAN Router Located Appropriately?

- The machine and wireless LAN router should be installed in a location without walls or other obstructions between the devices and within range of 50 m.
- Do not install near a microwave oven, digital cordless telephone, or other device that generates radio waves.

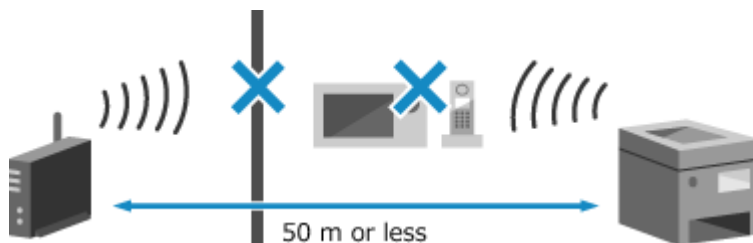

#### Check the Security Settings of the Wireless LAN Router.

For details, see the manual of the wireless LAN router or contact the manufacturer.

## Cannot print. A non-Canon or counterfeit cartridge may be in use. Close: Press OK

Printing cannot be performed due to the use of a toner cartridge whose print quality cannot be guaranteed.

### **Replace with a New Toner Cartridge.**

#### ▶ **Replacing the Toner Cartridge(P. 372)**

For optimum print quality, using Canon genuine toner cartridges is recommended. ▶ **List of Consumables(P. 378)**

## Cannot print RX data.

Received data cannot be printed for some reason.

### **Do the Cause and Solution Appear on the Control Panel?**

If so, follow the instructions on the screen.

### **Is the Front Cover, Rear Cover, or Feeder Cover Open on the Machine?**

Close the covers if they are open.

### **Is Paper Loaded?**

Load paper if not loaded. ▶ **Loading Paper(P. 104)**

### **Is Paper Jammed?**

If so, remove any jammed paper. ▶ **Paper Jams(P. 389)**

### **Have the Toner Cartridge Reached the End of Their Lifetime?**

Check the remaining amount of toner in the toner cartridge, and replace any toner cartridge, as needed.

#### ▶ **Checking the Remaining Amount of Consumables(P. 377)**

#### ▶ **Replacing the Toner Cartridge(P. 372)**

## Cartridge communication error. Cannot print. A non-Canon or counterfeit cartridge may be inserted.

Printing cannot be performed due to incorrect installation of the toner cartridge, a damaged toner cartridge, or the use of a toner cartridge whose print quality cannot be guaranteed.

### **Reinstall the Toner Cartridge or Replace with New Toner Cartridge.**

#### ▶ **Replacing the Toner Cartridge(P. 372)**

- For optimum print quality, using Canon genuine toner cartridges is recommended. ▶ **List of Consumables(P. 378)**
- If the message still appears after repeatedly reinstalling the toner cartridge, contact your dealer or service representative. ▶ **If the Problem Persists(P. 463)**

## Cart. end of lifetime. Rplcmt. recommended.

The toner cartridge has reached the end of their lifetime.

### **It Is Recommended to Replace with New Toner Cartridge.**

#### ▶ **Replacing the Toner Cartridge(P. 372)**

## Cartridge Communication Error Problems resulting from the use of non-Canon cartridges are not covered under the warranty.

Printing cannot be performed due to incorrect installation of the toner cartridge, a damaged toner cartridge, or the use of a non-Canon toner cartridge, resulting in a communication error.

### Reinstall the Toner Cartridge.

#### ▶ Replacing the Toner Cartridge(P. 372)

- For optimum print quality, using Canon genuine toner cartridges is recommended. ▶ **List of Consumables(P. 378)**
- If the message still appears after repeatedly reinstalling the toner cartridge, contact your dealer or service representative. ▶ **If the Problem Persists(P. 463)**

## Change the authentication password.

The password has expired.  
Set a new password.

## Check the authentication settings.

The authentication method set on the machine does not match that set on the RADIUS server.

### Check the Authentication Method Set on the RADIUS Server, and Set This Correctly.

#### ▶ Setting IEEE 802.1X(P. 215)

## Could not connect.

An error occurred, preventing the machine from establishing a direct connection.

### Wait a Moment, and Try Connecting Again.

If you still cannot establish a connection, restart the machine.

### Set the IP Address for Connection to Something Other Than "192.168.22.xx".

The machine must be restarted to apply the settings.

Log in to Remote UI in System Manager Mode ▶ [Settings/Registration] ▶ [Network Settings] ▶ [Direct Connection Settings] ▶ [Edit] ▶ in [IP Address for Direct Connection], enter the IP address ▶ [OK] ▶ restart the machine

On the control panel, select [Menu] in the [Home] screen, and then select [Preferences] to configure the setting. ▶ **[Direct Connection Settings](P. 288)**

### Is the Subnet Mask Configured Correctly?

Check the IPv4 subnet mask settings. Change the settings if they have not been configured correctly. For details, contact the network administrator.

#### ▶ Viewing the IP address set to the machine(P. 77)

#### ▶ Setting IPv4 Addresses(P. 58)

## Could not connect. Check the encryption key.

The network key (encryption key) of the wireless LAN router (access point) is not configured correctly, preventing connection.

### Reset the Network Key.



Check the network key of the wireless LAN router, and configure the settings correctly on the machine. **▶ Connecting to a Wireless LAN(P. 47)**

### Could not connect. Device will restart.

An error occurred, preventing the machine from connecting in Access Point Mode. Alternatively, an error occurred when starting cableless setup mode.

**Restart the Machine, and Start Cableless Setup Mode Again.**  
Administrator privileges are required.

[Home] on the control panel ▶ [Menu] ▶ **OK** ▶ [Preferences] ▶ **OK** ▶ [Network] ▶ **OK** ▶ [Easy Connection via PC] ▶ **OK** ▶ start the settings on the computer

### Could not connect. Max connections to access point reached

The maximum number of devices that can be connected to the wireless LAN router (access point) has been reached, preventing connection.

**Reduce the Number of Devices (Clients) Connected to the Wireless LAN Router.**  
For the maximum number of connections, see the manual of the wireless LAN router or contact the manufacturer.

### Could not connect using the wireless LAN.

An error occurred, preventing the machine from connecting to the wireless LAN.

**Restart the Machine, and Configure the Wireless LAN Connection Again.**  
**▶ Connecting to a Wireless LAN(P. 47)**

**Are the Machine and Wireless LAN Router (Access Point) Located Appropriately?**

- The machine and wireless LAN router should be installed in a location without walls or other obstructions between the devices and within range of 50 m.
- Do not install near a microwave oven, digital cordless telephone, or other device that generates radio waves.

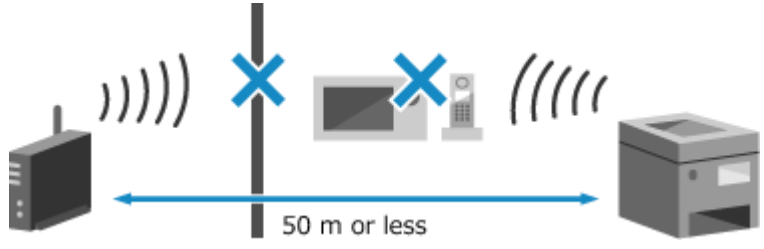

**Check the Security Settings of the Wireless LAN Router.**  
For details, see the manual of the wireless LAN router or contact the manufacturer.

### Could not connect using WPS. Wait a moment, then configure the settings again.

An error occurred, preventing the machine from establishing a WPS connection.

**Wait a Moment, and Configure the Settings Again.**  
If you still cannot establish a WPS connection, check whether the wireless LAN router (access point) supports WPS.

**If It Supports WPS**

Check that the machine and wireless LAN router are located appropriately.

- The machine and wireless LAN router should be installed in a location without walls or other obstructions between the devices and within range of 50 m.
- Do not install near a microwave oven, digital cordless telephone, or other device that generates radio waves.

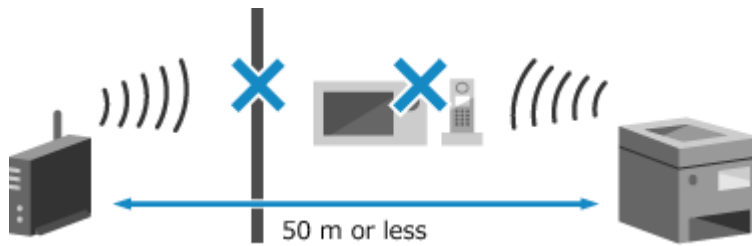

**If It Does Not Support WPS**

Connect using a different connection type. ▶ **Connecting to a Wireless LAN(P. 47)**

**Could not detect any connections from wireless devices.**

An error occurred, preventing the machine from detecting mobile devices.

**Did You Connect Within the Fixed Time?**

Connect the mobile device to the machine within five minutes of the SSID and network key being displayed.

**Could not perform cleaning.**

Cleaning could not be performed due to jammed paper, loading of incorrect paper, or another problem.

**Is Paper Loaded?**

Load paper in the paper drawer if not loaded. ▶ **Loading Paper in the Paper Drawer(P. 105)**

**Is Paper Jammed?**

If so, remove any jammed paper. ▶ **Paper Jams(P. 389)**

**Could not perform IEEE 802.1X authentication. Cannot analyze the authentication server certificate.**

Check the certificate of the authentication server, and change the setting, as needed.

**Check the Certificate of the RADIUS Server, and Change the Setting, as Needed.**

▶ **Setting IEEE 802.1X(P. 215)**

**Could not perform IEEE 802.1X authentication. Change the authentication password.**

The password has expired.

**Set a New Password.**

▶ **Setting IEEE 802.1X(P. 215)**

**Could not perform IEEE 802.1X authentication. Check the authentication settings.**

The authentication method set on the machine does not match that set on the RADIUS server.

**Check the Authentication Method Set on the RADIUS Server, and Set This Correctly.**

- ▶ **Setting IEEE 802.1X(P. 215)**

Could not perform IEEE 802.1X authentication. Configure the correct authentication information.

The authentication method or authentication information of IEEE 802.1X is not set correctly.

**Set the Authentication Method and Authentication Information (Keys and Certificates, Password, CA Certificate) Correctly.**

- ▶ **Setting IEEE 802.1X(P. 215)**
- ▶ **Managing and Verifying a Key and Certificate(P. 217)**

Could not perform IEEE 802.1X authentication. Configure the information required for authentication.

The authentication method or authentication information of IEEE 802.1X is not set correctly.

**Set the Authentication Method and Authentication Information (Keys and Certificates, Password, CA Certificate) Correctly.**

- ▶ **Setting IEEE 802.1X(P. 215)**
- ▶ **Managing and Verifying a Key and Certificate(P. 217)**

Could not perform IEEE 802.1X authentication. No reply from the destination.

The network connection may have a problem.

**Check the Network Status and Settings.**

- Check the Ethernet cable and switch status.
- Check the network key of the wireless LAN router, and configure the settings correctly on the machine.

Could not perform IEEE 802.1X authentication. The authentication server certificate has expired.

The server certificate sent from the RADIUS server has expired.

**Check the Expiry Date of the RADIUS Server.**

- ▶ **Setting IEEE 802.1X(P. 215)**

Could not perform IEEE 802.1X authentication. The authentication server certificate is incorrect.

A CA certificate that supports the certificate of the authentication server is not registered to the machine.

**Check the Certificate Information of the Authentication Server, and Register a Supported CA Certificate.**

- ▶ **Setting IEEE 802.1X(P. 215)**
- ▶ **Registering a Key and Certificate or CA Certificate Obtained from an Issuing Authority(P. 230)**

## Could not perform Open System auth. Chk encryp. key set.

The WEP authentication methods of the machine and wireless LAN router (access point) do not match, or MAC address filtering of the wireless LAN router is set to prevent a connection to the machine, thereby preventing Open System Authentication.

**Use the Manual Setup Method to Change the WEP Authentication Method to [Shared Key], and Connect Again.**

▶ **Connecting to a Wireless LAN by Setting the Details (Manual Setup Method)(P. 55)**

**In the MAC address filtering setting of the wireless LAN router, allow the connection to the machine.**

Check the MAC address of the machine, and configure the wireless LAN router to allow a connection from that MAC address. ▶ **Viewing the MAC Address and Connection Information of the Wireless LAN(P. 78)**  
For the setup method, see the manual of the wireless LAN router or contact the manufacturer.

## Could not perform Shared Key auth. Chk encryp. key set.

The network key (encryption key) of the wireless LAN router (access point) is not configured correctly, or the WEP authentication methods of the machine and wireless LAN router do not match, preventing Shared Key Authentication.

**Reset the Network Key.**

Check the network key of the wireless LAN router, and configure the settings correctly on the machine. ▶ **Connecting to a Wireless LAN(P. 47)**

**Match the WEP Authentication Method on the Machine and Wireless LAN Router.**

The machine may be set to Shared Key Authentication, and the wireless LAN router may be set to Open System Authentication. Change the WEP setting according to the authentication method you are using.

### When Using Open System Authentication

Connect to the wireless LAN using either of the following methods:

- Connect with the access point setup method. ▶ **Connecting to a Wireless LAN by Searching for a Router (Access Point Setup Method)(P. 53)**
- Using the Manual Setup Method, connect with the WEP authentication method set to [Open System]. ▶ **Connecting to a Wireless LAN by Setting the Details (Manual Setup Method)(P. 55)**

### When Using Shared Key Authentication

On the wireless LAN router, change the WEP authentication method to "Shared Key", and connect again. For the setup method, see the manual of the wireless LAN router or contact the manufacturer.

## Direct Connection terminated.

The connection with a mobile device was terminated.

**Directly Connect Again.**





▶ **Connecting a Mobile Device Directly to the Machine (Direct Connection)(P. 180)**

## Easy Conn. via PC ended due to timeout Device will restart.

30 minutes have elapsed since the start of the cableless setup mode without connecting to the computer.

**Restart the Machine, and Start Cableless Setup Mode Again.**

Administrator privileges are required.

[Home] on the control panel ▶ [Menu] ▶  ▶ [Preferences] ▶  ▶ [Network] ▶  ▶ [Easy Connection via PC] ▶  ▶ start the settings on the computer

## Encryption key not set correctly. Check encryption key set.

The network key (encryption key) of the wireless LAN router (access point) may not be configured correctly on the machine.

### Reset the Network Key.

Reset the network key. ▶ **Connecting to a Wireless LAN(P. 47)**

## Key Lock is enabled.

Usage of the control panel keys is restricted.

### Cancel the Key Lock Function with Remote UI.

▶ **Restricting Use of the Control Panel(P. 245)**

## Low Cartridge Level

It is nearing the time to replace the toner cartridge.

### Prepare New Toner Cartridge, and Replace the Old Ones, as Needed.

When printing large printing jobs, it is recommended to press [Display Cartridge Replacement Steps] and replace the toner cartridge while following the instructions on the screen. ▶ **Replacing the Toner Cartridge(P. 372)**

### To Continue Printing, Use the Procedure Below.

#### When I-Faxing

When receiving an I-Fax, the data may be saved to the memory of the machine without being printed to prevent printing text that is difficult to read or images that are difficult to see.

To continue printing, enable [Continue Printing When Amount in Cartridge Is Low].

Log in to Remote UI ▶ [Settings/Registration] ▶ [RX/Forwarding Settings] or [RX Settings] ▶ [Common Settings] ▶ [Edit] in [Common Settings] ▶ select the [Continue Printing When Amount in Cartridge Is Low] checkbox ▶ [OK]

On the control panel, select [Home] in the [Menu] screen, and then select [Function Settings] to configure the settings. ▶ **[Continue Print. When Amount in Cart. Low](P. 341)**

\* When this setting is enabled, the printing results may be light or faded.

## NOTE

- You can manually specify when this message appears (when toner is low). ▶ **[Displ. Timing for Cartridge Prep. Notif.](P. 282)**

## Mem. full. Check error w/Status Monitor key.

The memory is full with data that has not been printed due to an error.

### Cancel Printing of the Data with an Error, or Press [Skip Error] on the [Device Status] Screen.

▶ **Canceling Printing with the Control Panel(P. 168)**

▶ **Viewing the Print Job Status and Log(P. 169)**

## Memory full. Process secure print jobs.

The memory is full with Secure Print data that has not been printed.

### **Print the Secure Print Data Saved to the Memory.**

For details about how to print, see the procedure for when using the Secure Print function. ▶ **Step 2: Printing Secure Data by Entering a PIN or Password(P. 161)**

## No Paper

Usage of the control panel keys is restricted.

### **Load the Paper.**

Load the paper for printing reports, lists, or I-Faxes, and set the paper size and type. ▶ **Loading Paper(P. 104)**

## No reply from the destination.

The Ethernet cable may not be connected or there may be a problem with the switch. Check the Ethernet cable and switch status.

## No response from the host.

The machine is not connected correctly to the network.

### **Check the Settings of the Machine and Network, and Connect Again.**

#### **When Connected via Wireless LAN**

Configure the settings correctly according to your usage environment. ▶ **Connecting to a Wireless LAN(P. 47)**

#### **When Connected via Wired LAN**

Check that the Ethernet cable is properly connected. ▶ **Connecting to a Wired LAN(P. 46)**

## Paper jammed.

Paper jammed in the machine during printing.

### **Remove the Jammed Paper, and If Printing Does Not Resume Automatically, Try Printing Again.**

▶ **Paper Jams(P. 389)**

## Prepare a cartridge.

It is nearing the time to replace the toner cartridge.

### **Prepare New Toner Cartridge, and Replace the Old Ones, as Needed.**

When printing large jobs, it is recommended to replace the toner cartridge. ▶ **Replacing the Toner Cartridge(P. 372)**

### **To Continue Printing, Use the Procedure Below.**

#### **When I-Faxing**

When receiving an I-Fax, the data may be saved to the memory of the machine without being printed to prevent printing text that is difficult to read or images that are difficult to see.

To continue printing, enable [Continue Printing When Amount in Cartridge Is Low].

Log in to Remote UI ▶ [Settings/Registration] ▶ [RX/Forwarding Settings] or [RX Settings] ▶ [Common Settings] ▶ [Edit] in [Common Settings] ▶ select the [Continue Printing When Amount in Cartridge Is Low] checkbox ▶ [OK]

On the control panel, select [Menu] in the [Home] screen, and then select [Function Settings] to configure the settings. ▶ **[Continue Print. When Amount in Cart. Low](P. 341)**

\* When this setting is enabled, the printing results may be light or faded.

## NOTE

- You can manually specify when this message appears (when toner is low). ▶ **[Displ. Timing for Cartridge Prep. Notif.](P. 282)**

## Printing is restricted.

Printing is restricted due to Department ID Management.

### Log In with a Department ID That Does Not Restrict Printing.

For the Department ID and PIN, contact the system administrator.

### To Cancel Restriction, Change the [Restrict Functions] Setting of Your Department ID.

Log in to Remote UI in System Manager Mode ▶ [Settings/Registration] ▶ [User Management] ▶ [Department ID Management] ▶ select the Department ID to edit ▶ clear the [Restrict Color Print] and [Restrict Black & White Print] checkboxes ▶ [OK]

On the control panel, select [Menu] in the [Home] screen, and then select [Management Settings] to change the setting. ▶ **[Department ID Management](P. 345)**

## Problems caused by non-Canon cart. not covered by warranty. Close: Press OK

An error occurred due to the use of a toner cartridge whose print quality cannot be guaranteed.

### Replace with a New Toner Cartridge.

▶ **[Replacing the Toner Cartridge](P. 372)**

For optimum print quality, using Canon genuine toner cartridges is recommended. ▶ **[List of Consumables](P. 378)**

## Set the correct authentication information.

The authentication method or authentication information of IEEE 802.1X is not set correctly.

### Set the Authentication Method and Authentication Information (Keys and Certificates, Password, CA Certificate) Correctly.

▶ **[Setting IEEE 802.1X](P. 215)**

▶ **[Managing and Verifying a Key and Certificate](P. 217)**

## Set the information necessary for authentication.

The authentication method or authentication information of IEEE 802.1X is not set correctly.

### Set the Authentication Method and Authentication Information (Keys and Certificates, Password, CA Certificate) Correctly.

- ▶ **Setting IEEE 802.1X(P. 215)**
- ▶ **Managing and Verifying a Key and Certificate(P. 217)**

## Size/Settings Mismatch

The size of the paper loaded in the machine does not match that set on the control panel or printer driver.

### Match the Size of the Loaded Paper with the Paper Size Setting.

#### When Using the Loaded Paper

- Change the paper size setting on the control panel to match the size of the loaded paper.
  - ▶ **Setting the Paper Size and Type for the Paper Drawer(P. 120)**
  - ▶ **Setting the Paper Size and Type for the Multi-purpose Tray(P. 122)**
- When printing from a computer, change the paper size setting on the printer driver to match the size of the loaded paper. ▶ **Printing from a Computer(P. 154)**

#### When Reloading Paper

Load paper of the size set on the control panel or printer driver. ▶ **Loading Paper(P. 104)**

### Check That the Paper Guides Are Aligned with the Markings and Are Not Too Loose or Too Tight.

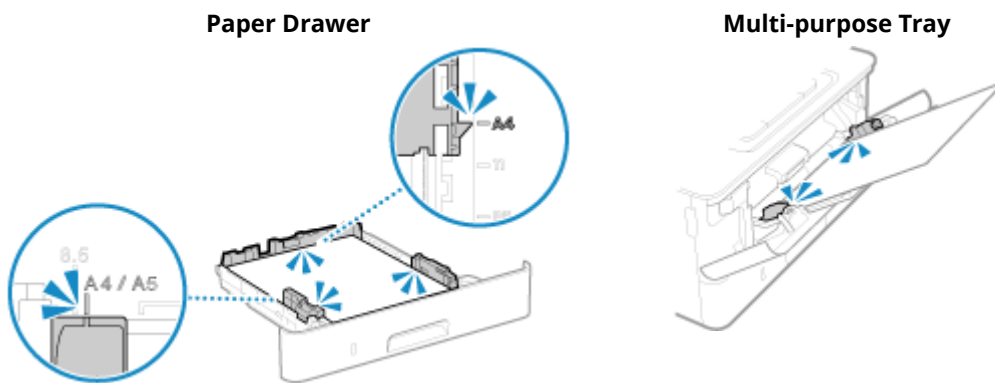

## The authentication server certificate has expired.

The server certificate sent from the RADIUS server has expired.

### Check the Expiry Date of the RADIUS Server.

- ▶ **Setting IEEE 802.1X(P. 215)**

## The authentication server certificate is incorrect.

A CA certificate that supports the certificate of the authentication server is not registered to the machine.

### Check the certificate information of the authentication server, and register a supported CA certificate.

- ▶ **Setting IEEE 802.1X(P. 215)**
- ▶ **Registering a Key and Certificate or CA Certificate Obtained from an Issuing Authority(P. 230)**

## The encryption key is not set correctly. Check the encryption key settings.

The network key (encryption key) of the wireless LAN router (access point) is not configured correctly on the machine. Alternatively, the WEP authentication method of the machine does not match that of the wireless LAN router.

### Reset the Network Key.

Check the network key of the wireless LAN router, and configure the settings correctly on the machine. ▶ **Connecting to a Wireless LAN(P. 47)**

### Match the WEP Authentication Method on the Machine and Wireless LAN Router.



The machine may be set to Shared Key Authentication, and the wireless LAN router may be set to Open System Authentication. Change the WEP setting according to the authentication method you are using.

#### When Using Open System Authentication

Connect to the wireless LAN using either of the following methods:

- Connect with the access point setup method. ▶ **Connecting to a Wireless LAN by Searching for a Router (Access Point Setup Method)(P. 53)**
- Using the Manual Setup Method, connect with the WEP authentication method set to [Open System]. ▶ **Connecting to a Wireless LAN by Setting the Details (Manual Setup Method)(P. 55)**

#### When Using Shared Key Authentication

On the wireless LAN router, change the WEP authentication method to "Shared Key", and connect again. For the setup method, see the manual of the wireless LAN router or contact the manufacturer.

### The memory is full.

Printing cannot be performed due to insufficient available memory. If there is data waiting to be printed, wait until the processing is completed.

#### Reduce the File Size or Divide the File.

Optimize the file to make it smaller, or divide the file and then print it.

### The number of entered characters is incorrect or invalid characters are used.

The network key of the wireless LAN router (access point) is not configured correctly on the machine.

#### Reset the Network Key.

Check the network key of the wireless LAN router, and configure the settings correctly on the machine. ▶ **Connecting to a Wireless LAN(P. 47)**

### Use Remote UI to set the information necessary for authentication.

The authentication method or authentication information of IEEE 802.1X is not set correctly.

#### Check the IEEE 802.1X Setting, and Set This Correctly.

Check the following, and change the setting, as needed. ▶ **Setting IEEE 802.1X(P. 215)**

- The login name is specified correctly.
- At least one of the following checkboxes is selected: [Use TLS], [Use TTLS], and [Use PEAP].
- When using TLS, a key and certificate are registered.
- When using TTLS or PEAP, the user name and password are set correctly.

# An Error Code Is Displayed

9664-0AU

If printing cannot be performed, an I-Fax cannot be received, or another error occurs, an error code (three-digit number starting with "#") is displayed in the job log.

Select the error code from the list below, and check how to troubleshoot the problem.

## #001 to #099

▶ #037(P. 458) ▶ #099(P. 458)

## #401 to #499

▶ #408(P. 458)

## #701 to #799

▶ #701(P. 459) ▶ #752(P. 459) ▶ #753(P. 459) ▶ #766(P. 459)

## #801 to #899

▶ #802(P. 459) ▶ #810(P. 460) ▶ #816(P. 460) ▶ #818(P. 460) ▶ #819(P. 460) ▶ #820(P. 460) ▶ #821(P. 460)  
▶ #822(P. 460) ▶ #827(P. 461) ▶ #829(P. 461) ▶ #852(P. 461) ▶ #853(P. 461) ▶ #861(P. 462) ▶ #863(P. 462)

## #901 to #999

▶ #934(P. 462) ▶ #995(P. 462)

## NOTE

- If the problem persists even after trying the troubleshooting methods, contact your dealer or service representative. ▶ **If the Problem Persists(P. 463)**

## #037

Printing could not be performed due to the file size.

### Reduce the File Size or Divide the File.

Optimize the file to make it smaller, or divide the file and then print it.

## #099

The job was canceled.

This does not indicate a malfunction. Perform the operation again, as needed.

## #408

The USB memory device may have been removed, or the USB memory device was formatted with an unsupported file system.

### Has the USB Memory Device Been Removed?

Confirm the orientation of the USB memory device, and insert it correctly into the machine. ▶ **Inserting and Removing a USB Memory Device(P. 129)**

### Was the USB Memory Device Formatted with a Supported File System?

You can use a USB memory device with a FAT16 or FAT32 file system.

## #701

Authentication could not be performed due to incorrect entry of the Department ID or PIN. Alternatively, the user attempted to perform an operation restricted with Department ID Management without entering the Department ID.

**Enter the Correct Department ID and PIN.**

If you lost your Department ID or PIN, contact the system administrator.

**To Cancel Restriction, Change the [Department ID Management] Setting.**

Log in to Remote UI in System Manager Mode ▶ [Settings/Registration] ▶ [User Management] ▶ [Department ID Management] ▶ [Edit] ▶ select the [Allow Print Jobs with Unknown IDs] checkbox ▶ [OK]

On the control panel, select [Menu] in the [Home] screen, and then select [Management Settings] to change the setting. ▶ **[Department ID Management](P. 345)**

## #752

The POP3 server name is not configured correctly, or the machine is not connected correctly to the network.

**Configure the POP3 Server Name Correctly.**

▶ **Preparing to Receive and Print I-Faxes(P. 152)**

**Check the Network Status and Settings.**

If the machine is not connected to a network, reconfigure the network settings.

▶ **Checking the Network Status and Settings(P. 76)**

▶ **Setting Up the Network(P. 43)**

## #753

The machine was unable to connect to the network due to a disconnected Ethernet cable.

**Check That the Ethernet Cable Is Properly Connected.**

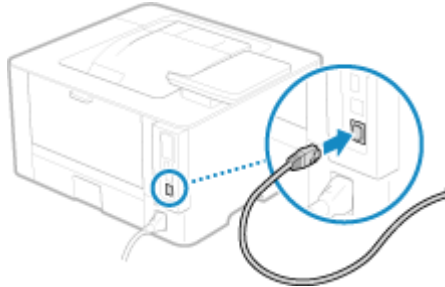

## #766

The certificate has expired.

**Renew the certificate, or use a certificate that is not expired.**

▶ **Managing and Verifying a Key and Certificate(P. 217)**

**Are the current date and time on the machine correct?**

Check the date and time settings. If the settings are not correct, set the time zone, and then set the current date and time. ▶ **Setting the Date and Time(P. 254)**

## #802

The POP3 server name is not set correctly.

**When Receiving an I-Fax, Correctly Set the POP3 Server Name.**

- ▶ **Preparing to Receive and Print I-Faxes(P. 152)**

**#810**

The machine cannot connect to the POP3 server, or the information of the POP3 server is not set correctly.

**Check the Network Status and Settings.**

If the machine is not connected to a network, reconfigure the network settings.

- ▶ **Checking the Network Status and Settings(P. 76)**
- ▶ **Setting Up the Network(P. 43)**

**Set the information of the POP3 server correctly.**

- ▶ **Preparing to Receive and Print I-Faxes(P. 152)**

**Check the Status of the POP3 Server.**

Check that the POP3 server is operating properly on the network. For details about the POP3 server status, contact your provider.

**#816**

The maximum number of pages that can be printed for the department has been reached.

**Check the Usage, and Reset the Count to Zero.**

- ▶ **Confirming Usage by Department ID(P. 201)**

**#818**

The received data is in a format that cannot be printed.  
Have the sender change the file format and resend the file.

**#819**

The received data has invalid MIME information and cannot be processed.  
Have the sender check the settings and resend the data.

**#820**

The received data has invalid BASE64 or uuencode data and cannot be processed.  
Have the sender check the settings and resend the data.

**#821**

The received data has a TIFF analysis error and cannot be processed.  
Have the sender check the settings and resend the data.

**#822**

The file format is unsupported, and printing cannot be performed.

**Save using a supported file format.**

The following file formats can be printed from a USB memory device:

- JPEG (DCF, Exif2.21 or earlier, JFIF)
- TIFF (JPEG, MH, MR, MMR compression)
- PDF

## #827

The received data includes unsupported MIME information and cannot be processed. Have the sender check the settings and resend the data.

## #829

The received data exceeds the maximum size that can be received by the machine.

### Have the Sender Check and Resend the Data.

#### When Receiving an I-Fax

The machine cannot receive an e-mail that exceeds 24 MB. Have the sender reduce the size of the e-mail to 24 MB or less and resend it.

## #852

The power of the machine turned OFF for some reason. Make sure the power plug is firmly inserted into an outlet.

## #853

Printing or Secure Print failed for some reason. If the operation was canceled when print data was being sent from a computer to the machine, try printing again. Otherwise, check the following:

#### Are You Printing a Large Job?







The data volume may have exceeded the processing capacity of the machine. Reduce the number of pages to print, or print when there is no print data being printed or waiting to be printed.

#### Is the Data to Be Printed Corrupted?

If the data is corrupted or otherwise damaged, fix the data.

#### Are You Trying to Print a PDF File from a USB Memory Device?

When printing a password-protected PDF file, enter the password before printing.

[Home] screen on the control panel ► [Memory Media Print] ►  ► [Select File and Print] ►  ► select the file to print ►  ► [<Apply>] ►  ► [Set PDF Details] ►  ► [Password to Open Document] ►  ► enter the password ► <Apply> ► 

#### Are You Trying to Print with Secure Print?

The machine may be configured not to use the Secure Print function. Try either of the following methods:

- Enable Secure Print.

The machine must be restarted to apply the settings.

Log in to Remote UI in System Manager Mode ► [Settings/Registration] ► [Secure Print Settings] ► [Edit] ► select the [Secure Print] checkbox ► [OK] ► restart the machine

On the control panel, select [Menu] in the [Home] screen, and then select [Function Settings] to configure the settings.  **[Secure Print](P. 316)**

- Print without using the Secure Print function.

#### Was the Secure Print Data Left for a While?

If printing of the Secure Print data is not performed after a set period of time, the data is deleted from the memory automatically. If the save period elapses and the data is deleted automatically, try printing with Secure Print again.

\* You can change the save period (time until the data is deleted). **▶ Changing the Time Period That Print Data with a PIN (Secure Data) Is Saved(P. 162)**

## #861

You are using an unsupported printer driver, or the data you are trying to print is corrupted.

**Use the printer driver of the machine, and try printing again.**

**▶ Printing from a Computer(P. 154)**

**Is the Data to Be Printed Corrupted?**

If the data is corrupted or otherwise damaged, fix the data.

## #863

An error occurred, preventing printing.

**Restart the Machine, and Then Print the Data Again.**

**▶ Restarting the Machine(P. 87)**

## #934

The job was deleted by the Auto Delete Suspended Jobs function.

**Resolve the Error That Caused the Job to Be Suspended.**

Resolve the error, and try printing again.

\* Disable the Auto Delete Suspended Jobs function, or change the time until the data is automatically deleted. **▶ [Auto Delete Suspended Jobs](P. 321)**

## #995

Receiving of a waiting job was canceled.  
Try receiving again, as needed.

## If the Problem Persists

9664-0AW

If the problem persists even after trying the troubleshooting methods, contact your dealer or service representative.

### **IMPORTANT**

**Do not disassemble or repair the machine yourself.**

- Disassembling or repairing the machine yourself may void the warranty.

### Checks Before Contacting Us

- Product name (LBP246dw / LBP243dw)
- Dealer purchased from
- Details of the problem (such as operation details and their results)
- Serial number

#### How to Look Up the Serial Number



- You can also check this information using Remote UI from a computer.  **Managing the Machine from a Computer (Remote UI)(P. 255)**
- You can also check this information on the label on the back of the machine.

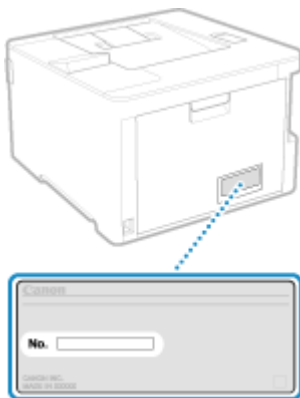

# Appendix

<b>Appendix</b> .....	465
<b>Manuals of the Machine</b> .....	466
<b>Using the User's Guide</b> .....	467
<b>Manual Display Settings</b> .....	469
<b>Operation Examples When Using a Computer</b> .....	470
<b>Environmental Information, Regulations, and Standards</b> .....	480
<b>Notice</b> .....	482
<b>Trademarks and Copyrights</b> .....	483
<b>Third-party Software</b> .....	485



# Appendix

---

9664-0AX

In this chapter, you can view the manuals of the machine and the basic operations required when using the machine with a computer.

## Manuals of the Machine

Manuals are provided according to your purpose.

### ▶ Manuals of the Machine(P. 466)

The User's Guide (this manual) contains information on all functions of the machine and specifications as well as how to maintain the machine. You can search for specific information and change the text size and layout.

### ▶ Using the User's Guide(P. 467)

### ▶ Manual Display Settings(P. 469)

## Basic Operations When Using with a Computer

You must set up a computer to use the machine from the computer and view information set on the machine from the computer. The operations are introduced using Windows and macOS operation examples.

### ▶ Operation Examples When Using a Computer(P. 470)

## Other Information

### ▶ Environmental Information, Regulations, and Standards(P. 480)

### ▶ Notice(P. 482)

### ▶ Trademarks and Copyrights(P. 483)

### ▶ Third-party Software(P. 485)

# Manuals of the Machine

---

9664-0AY

The manuals below are provided with the machine. Use these according to your purpose. Click on the icon to display the corresponding manual (PDF).

### Important Safety Instructions

This contains required information to prevent injury and accidental damage to property.



### Setup Guide

This explains the process from unpacking the machine to setting it up so that it is ready to use.



### User's Guide (this manual)

This describes all the functions of the machine in detail. It also contains the specifications and describes how to maintain the machine. The User's Guide is displayed in a Web browser.

▶ **Using the User's Guide(P. 467)**

## NOTE

- For details about the drivers, software, and manual of the Application Library, see the online manual site.  
<https://oip.manual.canon/>

# Using the User's Guide

9664-0C0

The User's Guide (this manual) contains information on all functions of the machine and specifications as well as how to maintain the machine.

You can use the User's Guide to find useful information through the contents and search function.

\* Click [☰] or [🔍] at the top of the screen to change between contents and search keyword display.

▶ **Screens and Illustrations(P. 467)**

▶ **Symbols(P. 467)**

▶ **Key and Button Indicators(P. 468)**

▶ **Search Function(P. 468)**

## NOTE

- The User's Guide describes the various functions of all model series including the machine. You can view a table indicating which functions and options are supported for each model. ▶ **Supported Functions and Options(P. 3)**

## Screens and Illustrations

In the User's Guide, unless otherwise stated, the following are used in the screens and illustrations.

**Model**

LBP246dw

**Toner Cartridge**

Canon Cartridge 070

**Computer Operating System**

Windows 10

macOS 11

- The operations and screens may vary depending on the computer operating system.
- The screens are subject to change due to updates of the drivers and software.

## Symbols

The warnings and cautions are also listed in the Important Safety Instructions supplied with the machine. See this for more information. ▶ **Manuals of the Machine(P. 466)**



Indicates a warning concerning operations that may lead to death or serious personal injury if not performed correctly. To ensure that you use the machine safely, always observe these warnings.



Indicates a precaution for preventing the risk of personal injury or property damage other than a product fault due to improper use of the machine. To ensure that you use the machine safely, always observe these cautions.



Indicates an operation that must not be performed. Read these items carefully, and make sure not to perform the described operations.



## IMPORTANT

Indicates important requirements and restrictions for security and data protection as well as precautions that should be observed. Be sure to read these items to avoid malfunction, fault, or property damage due to incorrect operation.

## NOTE

Indicates a clarification of an operation, or contains additional explanations for a procedure.

## Key and Button Indicators

The control panel keys and buttons displayed on the screen are indicated as follows:

### control panel Keys

Indicated with an icon.

**Example:** Home key



### Buttons Displayed on the control panel and Computer Screen

Enclosed in square brackets [ ].

**Example:**



[Cancel] ▶ [Yes]

[The memory media can be safely removed.]

## Search Function



### 1 Click [ ] at the top of the screen.

⇒ The search keyword input field is displayed at the top left of the screen.

### 2 Enter a keyword, and click [ ] or press the [Enter] key on the computer.

- Separate multiple keywords with spaces to search for pages that include all keywords.
- Enclose keywords in double quotation marks ("") to search for pages that only contain complete matches including spaces.

### 3 Click the search result to view the page.

- Click [  ] to show or hide the search results.
- Click [  ] to display the contents.

# Manual Display Settings

---

9664-0C1

# Operation Examples When Using a Computer

9664-0C2

When using the machine from a computer, you must configure the settings of the computer according to the function you are using. In addition, you may need the computer information to view the information set on the machine. In this case, use the operation examples below to check the required settings and information on the computer.

- ▶ **Creating a Shared Folder(P. 470)**
- ▶ **Enabling Network Discovery(P. 472)**
- ▶ **Displaying a Shared Printer in the Print Server(P. 472)**
- ▶ **Viewing the System Information of the Computer(P. 473)**
- ▶ **Viewing the Network Connection Information of the Computer(P. 475)**
- ▶ **Viewing the Printer Port(P. 477)**
- ▶ **Viewing Two-way Communication(P. 478)**
- ▶ **Printing a Test Page(P. 478)**

## Creating a Shared Folder

- ▶ **When Using Windows(P. 470)**
- ▶ **When Using macOS(P. 471)**

### ■ When Using Windows

#### 1 Create a folder in any location (such as Desktop).

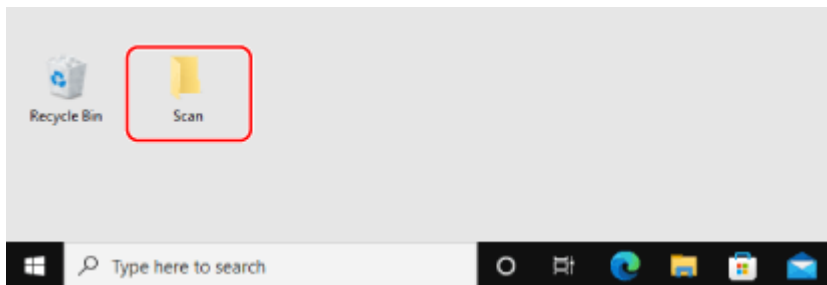

#### 2 Right-click the created folder, and click [Properties].

#### 3 On the [Sharing] tab, click [Advanced Sharing].

⇒ The [Advanced Sharing] screen is displayed.

#### 4 Select the [Share this folder] checkbox, and click [Permissions].

#### 5 Configure the access privilege.

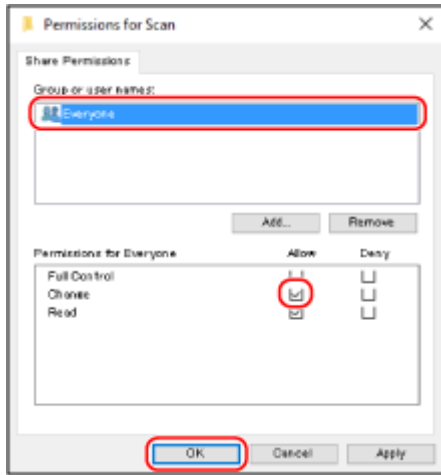

- 1 In [Group or user names], select [Everyone].
- 2 In [Permissions], select the [Allow] checkbox in [Change].
- 3 Click [OK].

## 6 Click [OK] ► [Close].

►► The created folder can be used as a shared folder.

### ■ When Using macOS

## 1 Click [Apple] ► [System Preferences] ► [Sharing].

►► The [Sharing] screen is displayed.

## 2 Select the [File Sharing] checkbox, and click [+] in [Shared Folders].

## 3 Create a folder in any location (such as Desktop), and click [Add].

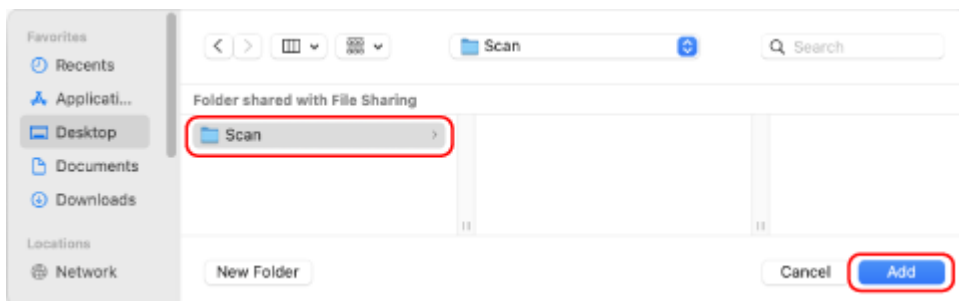

## 4 Configure the access privilege.

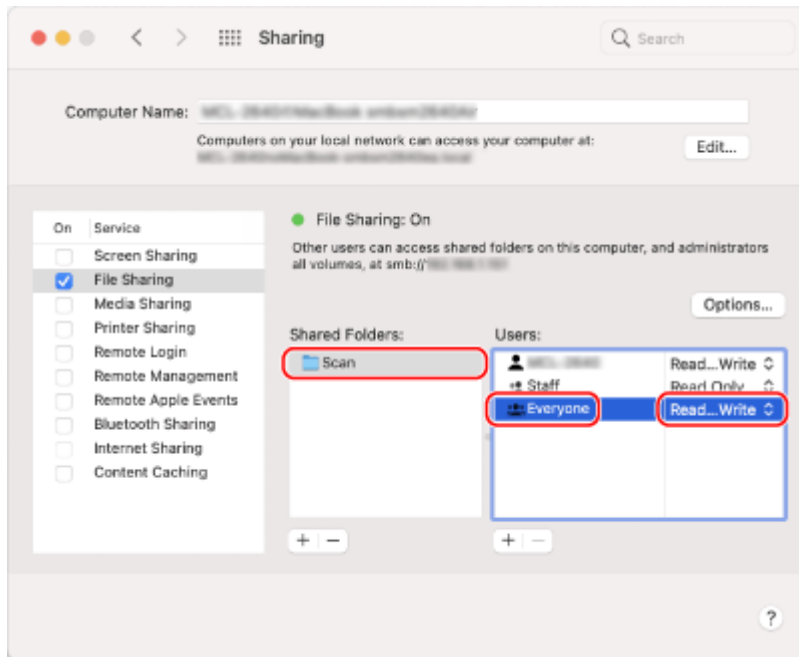

- 1 In [Shared Folders], select the created folder.
- 2 In [Users], select [Everyone] ► [Read & Write].

## 5 Close the screen.

►► The created folder can be used as a shared folder.

## Enabling Network Discovery

### 1 Right-click [⊞] (Start), and click [Network Connections].

►► The [Status] screen is displayed.

### 2 Click [Network and Sharing Center] ► [Change advanced sharing settings].

►► The [Advanced sharing settings] screen is displayed.

### 3 In [Network discovery], select [Turn on network discovery], and click [Save changes].

## Displaying a Shared Printer in the Print Server

- When Using Windows(P. 473)
- When Using macOS(P. 473)



## ■ When Using Windows

- 1 Right-click [⊞] (Start), and click [File Explorer].
- 2 In [Network], select the print server to display the shared printer.

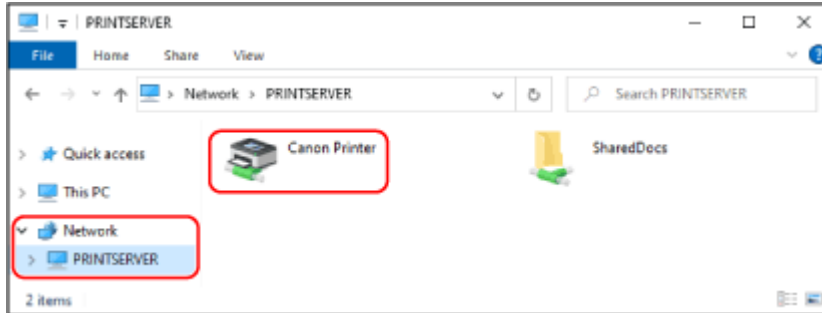

If nothing is displayed in [Network], enable network discovery. ▶ [Enabling Network Discovery\(P. 472\)](#)

## ■ When Using macOS

- 1 Click [🍏] ▶ [System Preferences] ▶ [Printers & Scanners].

⇒ The [Printers & Scanners] screen is displayed.

- 2 Click [+] at the bottom left.

⇒ The [Add] screen is displayed.

- 3 Click [🖨️], to display the shared printer.

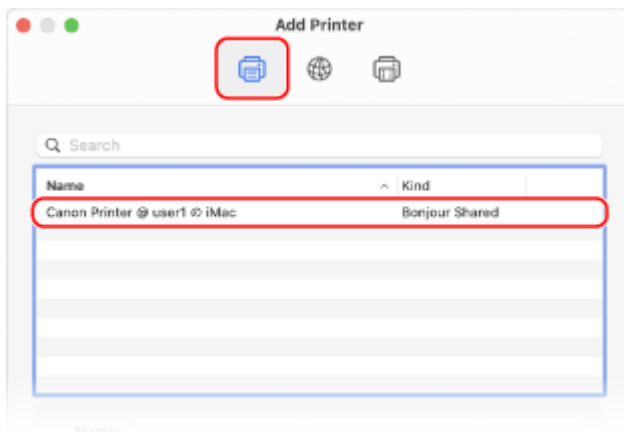

## Viewing the System Information of the Computer

- ▶ [When Using Windows\(P. 474\)](#)
- ▶ [When Using macOS\(P. 474\)](#)

## ■ When Using Windows

### 1 Right-click [Start] (Windows logo), and click [System].

⇒ The [About] screen is displayed.

### 2 In [Device specifications], view the computer name and operating system version.

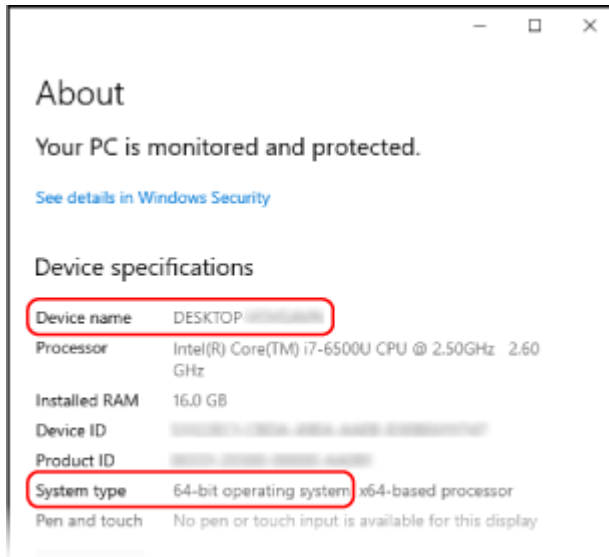

- The computer name is displayed in [Device name].
- The operating system version is displayed in [System type].  
If the computer has a 32-bit operating system, "32-bit Operating System" is displayed.  
If the computer has a 64-bit operating system, "64-bit Operating System" is displayed.

## ■ When Using macOS

### 1 Click [Apple logo] ▶ [System Preferences] ▶ [Sharing].

⇒ The [Sharing] screen is displayed.

The name displayed in [Computer Name] on the [Sharing] screen may not be usable on the network. Use the following procedure to view the computer name used on the network.

### 2 Click [Edit].

### 3 In [Local Hostname], view the computer name.

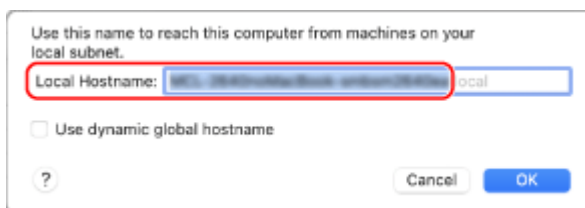

Parts displayed in gray are not included in the computer name.

## 4 Click [Cancel].

### Viewing the Network Connection Information of the Computer

▶ When Using Windows(P. 475)

▶ When Using macOS(P. 476)

#### ■ When Using Windows

## 1 Right-click [ ] (Start), and click [Network Connections].

⇒ The [Status] screen is displayed.

## 2 View the network connection information.

### ■ Viewing the SSID of the Wired LAN

View the SSID in [Network status].

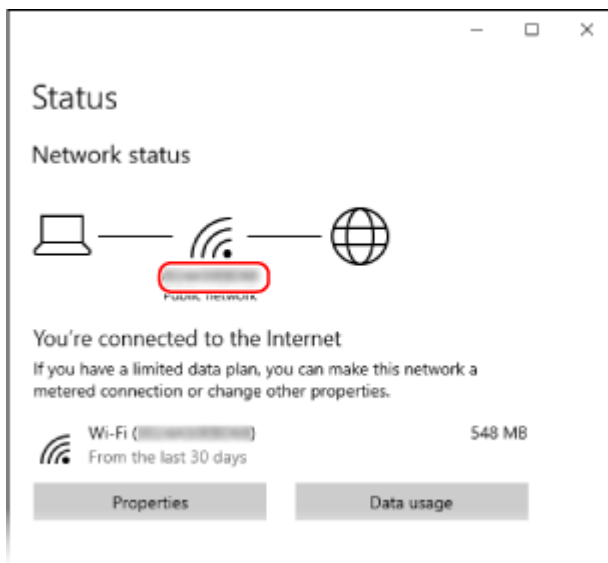

### ■ Viewing the IP Address and DNS Server

- 1 Click [Properties] for the connected network.
- 2 In [Properties], view the IP address and DNS server.

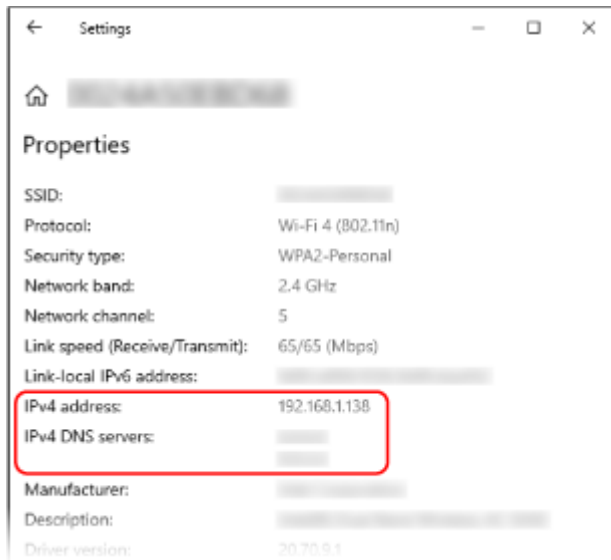

## ■ When Using macOS

**1** Click [🍏] ► [System Preferences] ► [Network].

⇒ The [Network] screen is displayed.

**2** View the IP address, DNS server, and other information.

### ■ For Wired LAN

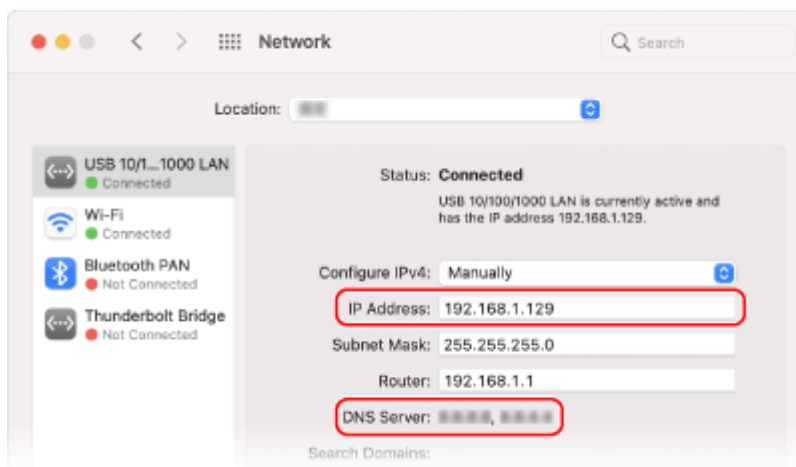

## ■ For Wireless LAN

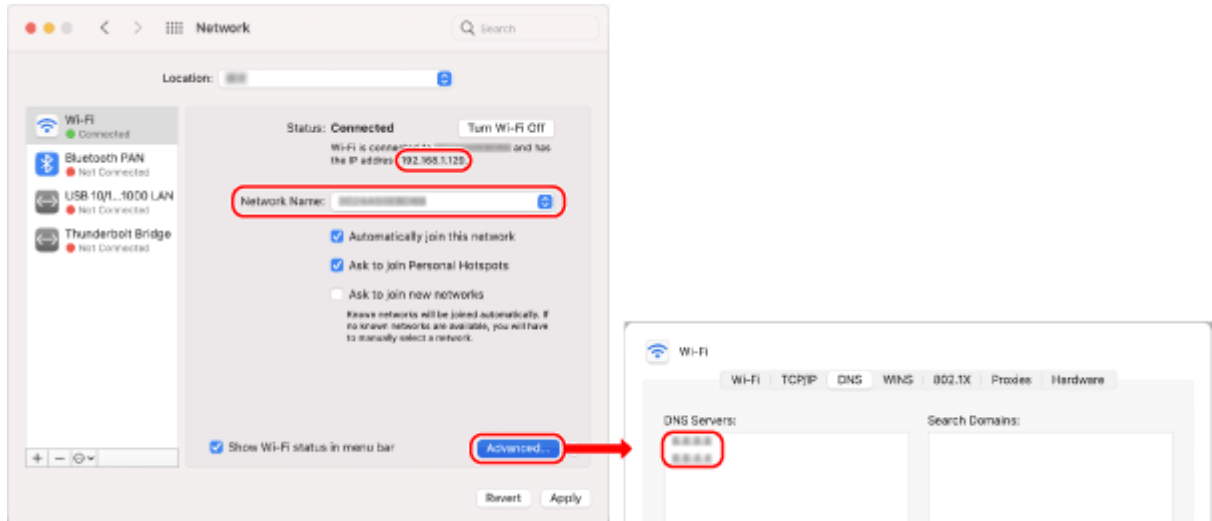

- View the SSID in [Network Name].
- View the IP address in [Status].
- Click [Advanced], and view the DNS server on the [DNS] tab.

## Viewing the Printer Port

### 1 Click [Start] ► [Settings] ► [Devices] ► [Printers & scanners].

► The [Printers & scanners] screen is displayed.

### 2 Click the printer driver of the machine ► [Manage] ► [Printer properties].

► The printer driver properties screen is displayed.

### 3 On the [Ports] tab, view the port being used.

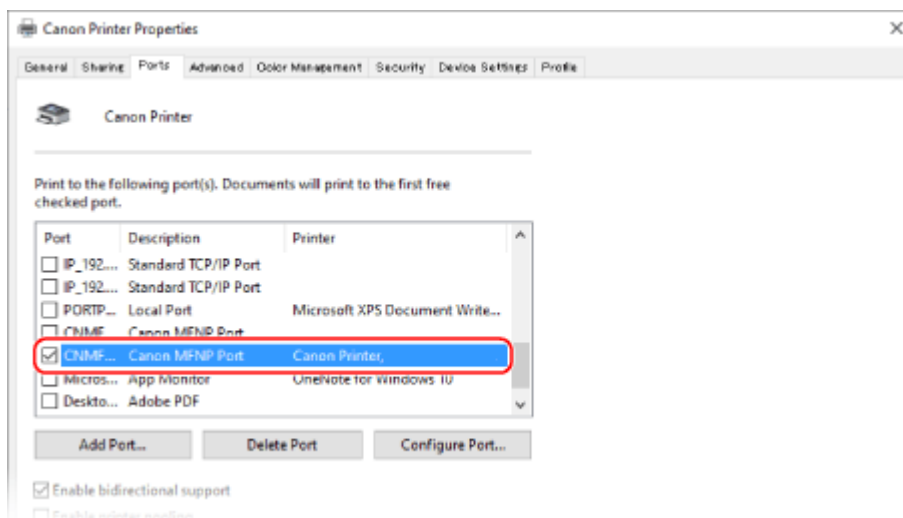

**NOTE**

### If the IP Address of the Machine Is Changed

- You must add a new port. ▶ [Adding a Port\(P. 141\)](#)

## Viewing Two-way Communication

- 1 Click [Start] (Start) ▶ [Settings] (Settings) ▶ [Devices] ▶ [Printers & scanners].

⇒ The [Printers & scanners] screen is displayed.

- 2 Click the printer driver of the machine ▶ [Manage] ▶ [Printer properties].

⇒ The printer driver properties screen is displayed.

- 3 On the [Ports] tab, check that the [Enable bidirectional support] checkbox is selected.

## Printing a Test Page

### Required Preparations

- Load A4 size paper in the paper drawer. ▶ [Loading Paper in the Paper Drawer\(P. 105\)](#)

▶ [When Using Windows\(P. 478\)](#)

▶ [When Using macOS\(P. 478\)](#)

### ■ When Using Windows

- 1 Click [Start] (Start) ▶ [Settings] (Settings) ▶ [Devices] ▶ [Printers & scanners].

⇒ The [Printers & scanners] screen is displayed.

- 2 Click the printer driver of the machine ▶ [Manage] ▶ [Printer properties].

⇒ The printer driver properties screen is displayed.

- 3 On the [General] tab, click [Print Test Page].

⇒ When the print data is sent correctly, a test page is printed from the machine.

### ■ When Using macOS

- 1 Click [Apple] ▶ [System Preferences] ▶ [Printers & Scanners].

⇒ The [Printers & Scanners] screen is displayed.

**2** Select the machine, and click [Open Print Queue].

**3** From the [Printer] menu, click [Print Test Page].

⇒ When the print data is sent correctly, a test page is printed from the machine.

# Environmental Information, Regulations, and Standards

9664-0C3

## ■ IPv6 Ready Logo



The protocol stack included in this product has obtained the IPv6 Ready Logo Phase-2 established by the IPv6 Forum.

## ■ Product Information required by COMMISSION REGULATION (EU) No.801/2013 amending Regulation (EC) No.1275/2008

Power consumption of a product in networked standby mode where wired network ports are connected and all wireless network ports are activated (if available at the same time).

Model Name	Power consumption of the product in networked standby mode
LBP246dw / LBP243dw	3.0 W or less

## NOTE

- The above value(s) are the actual values for a single machine, chosen arbitrarily, and may therefore differ from the value(s) of the actual machine used. Optional network ports are either not connected or not activated in the measurement.

## ■ EU WEEE and Battery Directives



Only for European Union and EEA (Norway, Iceland and Liechtenstein)

These symbols indicate that this product is not to be disposed of with your household waste, according to the WEEE Directive (2012/19/EU), the Battery Directive (2006/66/EC) and/or national legislation implementing those Directives. If a chemical symbol is printed beneath the symbol shown above, in accordance with the Battery Directive, this indicates that a heavy metal (Hg = Mercury, Cd = Cadmium, Pb = Lead) is present in this battery or accumulator at a concentration above an applicable threshold specified in the Battery Directive.

This product should be handed over to a designated collection point, e.g., on an authorized one-for-one basis when you buy a new similar product or to an authorized collection site for recycling waste electrical and electronic equipment (EEE) and batteries and accumulators. Improper handling of this type of waste could have a possible impact on the environment and human health due to potentially hazardous substances that are generally associated with EEE. Your cooperation in the correct disposal of this product will contribute to the effective usage of natural resources.

For more information about the recycling of this product, please contact your local city office, waste authority, approved scheme or your household waste disposal service or visit [www.canon-europe.com/sustainability/approach/](http://www.canon-europe.com/sustainability/approach/).



## ■ Environmental Information

### Reducing your environmental impact while saving money

#### Power Consumption and Activation Time

The amount of electricity a device consumes depends on the way the device is used. This product is designed and set in a way to allow you to reduce your electricity costs. After the last print it switches to Ready Mode. In this mode it can print again immediately if required. If the product is not used for a time, the device switches to its Power Save Mode. The devices consume less power (Watt) in these modes.

If you wish to set a longer Activation Time or would like to completely deactivate the Power Save Mode, please consider that this device may then only switch to a lower energy level after a longer period of time or not at all. Canon does not recommend extending the Activation Times from the optimum ones set as default.

#### Energy Star®

The Energy Star® programme is a voluntary scheme to promote the development and purchase of energy efficient models, which help to minimise environmental impact.

Products which meet the stringent requirements of the Energy Star® programme for both environmental benefits and the amount of energy consumption will carry the Energy Star® logo accordingly.

#### Paper types

This product can be used to print on both recycled and virgin paper (certified to an environmental stewardship scheme), which complies with EN12281 or a similar quality standard. In addition it can support printing on media down to a weight of 64g/m<sup>2</sup>.

Lighter paper means less resources used and a lower environmental footprint for your printing needs.

#### Duplex printing (Standard duplex printing products only)

Duplex printing capability enables you to print on both sides automatically, and therefore helps to reduce the use of valuable resources by reducing your paper consumption.

The duplex function has been auto enabled during the set up and driver installation and Canon strongly recommends that you do not disable this function. You should continue to use the duplex function to reduce the environmental impact of your work with this product at all times.

## ■ When disposing of used toner cartridges

- To protect the environment and make more effective use of resources, Canon promotes the recovery and recycling of used toner cartridges. Please cooperate in the recovery of toner cartridges (resource reuse). For details on resource reuse, see the Canon website:

[global.canon/ctc](http://global.canon/ctc)

When disposing of toner cartridges, pack them in their original packaging to prevent toner dispersal and dispose of the cartridges in accordance with your local government instructions.

## Notice

---

9664-0C4

- The information in this document is subject to change without notice.
- CANON INC. MAKES NO WARRANTY OF ANY KIND WITH REGARD TO THIS MANUAL, EITHER EXPRESS OR IMPLIED, EXCEPT AS STIPULATED HEREIN, INCLUDING WITHOUT LIMITATION THEREOF WARRANTIES AS TO MARKETABILITY, MERCHANTABILITY, FITNESS FOR A PARTICULAR PURPOSE OF USE, OR NON-INFRINGEMENT OF PATENT RIGHTS. CANON INC. SHALL NOT BE LIABLE FOR ANY DIRECT, INCIDENTAL OR CONSEQUENTIAL DAMAGES OF ANY NATURE, NOR FOR LOSSES OR EXPENSES RESULTING FROM THE USE OF THIS MANUAL.
- If you are unable to view the manual in PDF format, download Adobe Acrobat Reader from the Adobe Systems website (<https://get.adobe.com/reader/>).

## Trademarks and Copyrights

---

9664-0C5

### ■ Trademarks

Adobe, Acrobat and Reader are registered trademarks of Adobe Systems Incorporated in the United States and/or other countries.

Apple, Bonjour, iPad, iPhone, iPod touch, Mac, macOS, OS X, and Safari are trademarks of Apple Inc. AirPrint and the AirPrint logo are trademarks of Apple Inc.

iOS is a trademark or registered trademark of Cisco in the U.S. and other countries and is used under license.

Mopria®, the Mopria® Logo and the Mopria® Alliance logo are registered trademarks and service marks of Mopria Alliance, Inc. in the United States and other countries. Unauthorized use is strictly prohibited.

Google Chrome, Chrome OS, Chromebook, and Android are trademarks of Google LLC.

This product contains the Universal Font Scaling Technology or UFST® under license from Monotype Imaging, Inc.

UFST® is a trademark of Monotype Imaging, Inc. registered in the United States Patent and Trademark Office and may be registered in certain jurisdictions.

UFST: Copyright © 1989 - 1996, 1997, 2003, 2004, 2008, 2014 all rights reserved, by Monotype Imaging Inc.



Copyright © 2007 -08 Adobe Systems Incorporated. All rights reserved.

Protected by U.S. Patents 5,737,599; 5,781,785; 5,819,301; 5,929,866; 5,943,063; 6,073,148; 6,515,763; 6,639,593; 6,754,382; 7,046,403; 7,213,269; 7,242,415; Patents pending in the U.S. and other countries.

All instances of the name PostScript in the text are references to the PostScript language as defined by Adobe Systems Incorporated unless otherwise stated. The name PostScript also is used as a product trademark for Adobe Systems' implementation of the PostScript language interpreter.

Except as otherwise stated, any reference to a "PostScript printing device," "PostScript display device," or similar item refers to a printing device, display device or item (respectively) that contains PostScript technology created or licensed by Adobe Systems Incorporated and not to devices or items that purport to be merely compatible with the PostScript language.

Adobe, the Adobe logo, PostScript, the PostScript logo, and PostScript 3 are either registered trademarks or trademarks of Adobe Systems Incorporated in the United States and/or other countries.

Linux is a registered trademark of Linus Torvalds. Microsoft and Windows are either registered trademarks or trademarks of Microsoft Corporation in the United States and/or other countries.

All other trademarks are the property of their respective owners.

All brand names and product names appearing on this document are registered trademarks or trademarks of their respective owners.

All other trademarks are the property of their respective owners.

■ Copyright

Unauthorized reproduction of the contents of this document in whole or in part is prohibited.

V\_230207

# Third-party Software

---

9664-0C6

For details about third-party software, click the following icon:

**Third-Party Services**



**Third-Party Software Included in This Manual**



This Font Software is licensed under the SIL Open Font License, Version 1.1.

This license is copied below, and is also available with a FAQ at: <http://scripts.sil.org/OFL>

-----  
SIL OPEN FONT LICENSE Version 1.1 - 26 February 2007  
-----

#### PREAMBLE

The goals of the Open Font License (OFL) are to stimulate worldwide development of collaborative font projects, to support the font creation efforts of academic and linguistic communities, and to provide a free and open framework in which fonts may be shared and improved in partnership with others.

The OFL allows the licensed fonts to be used, studied, modified and redistributed freely as long as they are not sold by themselves. The fonts, including any derivative works, can be bundled, embedded, redistributed and/or sold with any software provided that any reserved names are not used by derivative works. The fonts and derivatives, however, cannot be released under any other type of license. The requirement for fonts to remain under this license does not apply to any document created using the fonts or their derivatives.

#### DEFINITIONS

"Font Software" refers to the set of files released by the Copyright Holder(s) under this license and clearly marked as such. This may include source files, build scripts and documentation.

"Reserved Font Name" refers to any names specified as such after the copyright statement(s).

"Original Version" refers to the collection of Font Software components as distributed by the Copyright Holder(s).

"Modified Version" refers to any derivative made by adding to, deleting, or substituting -- in part or in whole -- any of the components of the Original Version, by changing formats or by porting the Font Software to a new environment.

"Author" refers to any designer, engineer, programmer, technical writer or other person who contributed to the Font Software.

#### PERMISSION & CONDITIONS

Permission is hereby granted, free of charge, to any person obtaining a copy of the Font Software, to use, study, copy, merge, embed, modify, redistribute, and sell modified and unmodified copies of the Font Software, subject to the following conditions:

- 1) Neither the Font Software nor any of its individual components, in Original or Modified Versions, may be sold by itself.
- 2) Original or Modified Versions of the Font Software may be bundled, redistributed and/or sold with any software, provided that each copy contains the above copyright notice and this license. These can be included either as stand-alone text files, human-readable headers or in the appropriate machine-readable metadata fields within text or binary files as long as those fields can be easily viewed by the user.
- 3) No Modified Version of the Font Software may use the Reserved Font Name(s) unless explicit written permission is granted by the corresponding Copyright Holder. This restriction only applies to the primary font name as presented to the users.
- 4) The name(s) of the Copyright Holder(s) or the Author(s) of the Font Software shall not be used to promote, endorse or advertise any Modified Version, except to acknowledge the contribution(s) of the Copyright Holder(s) and the Author(s) or with their explicit written permission.
- 5) The Font Software, modified or unmodified, in part or in whole, must be distributed entirely under this license, and must not be distributed under any other license. The requirement for fonts to remain under this license does not apply to any document created using the Font Software.

#### TERMINATION

This license becomes null and void if any of the above conditions are not met.

#### DISCLAIMER

THE FONT SOFTWARE IS PROVIDED "AS IS", WITHOUT WARRANTY OF ANY KIND, EXPRESS OR IMPLIED, INCLUDING BUT NOT LIMITED TO ANY WARRANTIES OF MERCHANTABILITY, FITNESS FOR A PARTICULAR PURPOSE AND NONINFRINGEMENT OF COPYRIGHT, PATENT, TRADEMARK, OR OTHER RIGHT. IN NO EVENT SHALL THE COPYRIGHT HOLDER BE LIABLE FOR ANY CLAIM, DAMAGES OR OTHER LIABILITY, INCLUDING ANY GENERAL, SPECIAL, INDIRECT, INCIDENTAL, OR CONSEQUENTIAL DAMAGES, WHETHER IN AN ACTION OF CONTRACT, TORT OR OTHERWISE, ARISING FROM, OUT OF THE USE OR INABILITY TO USE THE FONT SOFTWARE OR FROM OTHER DEALINGS IN THE FONT SOFTWARE.

## **Third-Party Services**

If you use third-party services through the PRODUCT, use of the services are subjected the conditions below.

When you access and/or obtain some third party content (such as text, images, videos, audios, or software) through the SOFTWARE, except as expressly permitted by the content owner or by applicable law, you may not (a) scrape, build databases or otherwise create permanent copies of such content, or keep cached copies longer than permitted by the cache header; (b) copy, translate, modify, create a derivative work of, sell, lease, lend, convey, distribute, publicly display or sublicense to any third party; (c) misrepresent the source or ownership; and (d) remove, obscure, or alter any copyright, trademark or other proprietary rights notices, falsify or delete any author attributions, legal notices or other labels of the origin or source of material.



## The Software Subjected to Other License Conditions

Please refer to Contents of Software and respective License terms below, for more detail and corresponding license conditions.

### Contents of Software

#### Names of Software

1. Adobe PDF Scan Library .....	3
2. Adobe PostScript 3 .....	6
3. expat .....	13
4. HarfBuzz .....	14
5. libjingle .....	15
6. Lua .....	15
7. LuaSocket .....	17
8. LuneScript .....	18
9. MD4 .....	19
10. Net-SNMP .....	19
11. OpenSSL .....	39

## 1. Adobe PDF Scan Library

Portions use software under the following terms:

-----  
This product contains either BSAFE and/or TIPEM software by RSA Security Inc.  
-----

This product includes software developed by the Apache Software Foundation (<http://www.apache.org/>).

Copyright (c) 1998–2000 The Apache Software Foundation. All rights reserved.

Redistribution and use in source and binary forms, with or without modification, are permitted provided that the following conditions are met:

1. Redistributions of source code must retain the above copyright notice, this list of conditions and the following disclaimer.
2. Redistributions in binary form must reproduce the above copyright notice, this list of conditions and the following disclaimer in the documentation and/or other materials provided with the distribution.
3. The end–user documentation included with the redistribution, if any, must include the following acknowledgment:

"This product includes software developed by the Apache Software Foundation (<http://www.apache.org/>)."

Alternately, this acknowledgment may appear in the software itself, if and wherever such third–party acknowledgments normally appear.

4. The names "Xerces" and "Apache Software Foundation" must not be used to endorse or promote products derived from this software without prior written permission. For written permission, please contact [apache@apache.org](mailto:apache@apache.org).
5. Products derived from this software may not be called "Apache", nor may "Apache" appear in their name, without prior written permission of the Apache Software Foundation.

THIS SOFTWARE IS PROVIDED ``AS IS" AND ANY EXPRESSED OR IMPLIED WARRANTIES, INCLUDING, BUT NOT LIMITED TO, THE IMPLIED WARRANTIES OF MERCHANTABILITY AND FITNESS FOR A PARTICULAR PURPOSE ARE DISCLAIMED. IN NO EVENT SHALL THE APACHE SOFTWARE FOUNDATION OR ITS CONTRIBUTORS BE LIABLE FOR ANY DIRECT, INDIRECT, INCIDENTAL, SPECIAL, EXEMPLARY, OR CONSEQUENTIAL DAMAGES (INCLUDING, BUT NOT LIMITED TO, PROCUREMENT OF SUBSTITUTE GOODS OR SERVICES; LOSS OF USE, DATA, OR PROFITS; OR BUSINESS INTERRUPTION) HOWEVER CAUSED AND ON ANY THEORY OF LIABILITY, WHETHER IN CONTRACT, STRICT LIABILITY, OR TORT

(INCLUDING NEGLIGENCE OR OTHERWISE) ARISING IN ANY WAY OUT OF THE USE OF THIS SOFTWARE, EVEN IF ADVISED OF THE POSSIBILITY OF SUCH DAMAGE.

This software consists of voluntary contributions made by many individuals on behalf of the Apache Software Foundation and was originally based on software copyright (c) 1999, International Business Machines, Inc., <http://www.ibm.com>. For more information on the Apache Software Foundation, please see <http://www.apache.org/>.

---

March 27, 2003

Portions of this product are based on Modifications created from the Original Code known as the "Sablotron XSLT Processor". The Sablotron XSLT Processor is subject to the Mozilla Public License Version 1.1 (the "License"). You may obtain a copy of the License at <http://www.mozilla.org/MPL/>

Software distributed under the License is distributed on an "AS IS" basis, WITHOUT WARRANTY OF ANY KIND, either express or implied. See the License for the specific language governing rights and limitations under the License.

The Original Code is the Sablotron XSLT Processor.

The Initial Developer of the Original Code is Ginger Alliance Ltd. Portions created by Ginger Alliance are Copyright (C) 2000 Ginger Alliance Ltd. All Rights Reserved.

Pursuant to sections 3.2 and 3.6 of the License, the Modifications created by Adobe Systems Incorporated are available as Source Code. The Modifications may be downloaded via the Internet from:

<http://partners.adobe.com/asn/tech/xml/sablotron/index.jsp>

The Original Code may be downloaded via the Internet from:

<https://sourceforge.net/projects/sablotron/>

---

Portions Copyright (c) 1997–1999 Silicon Graphics Computer Systems, Inc.

Permission to use, copy, modify, distribute and sell this software and its documentation for any purpose is hereby granted without fee, provided that the above copyright notice appear in all copies

and that both that copyright notice and this permission notice appear in supporting documentation. Silicon Graphics makes no representations about the suitability of this software for any purpose. It is provided "as is" without express or implied warranty.

---

The Loki Library

Portions Copyright (c) 2001 by Andrei Alexandrescu . This code accompanies the book: Alexandrescu, Andrei. "Modern C++ Design: Generic Programming and Design Patterns Applied".

Portions Copyright (c) 2001. Addison-Wesley. Permission to use, copy, modify, distribute and sell this software for any purpose is hereby granted without fee, provided that the above copyright notice appear in all copies and that both that copyright notice and this permission notice appear in supporting documentation. The author or Addison-Wesley Longman make no representations about the suitability of this software for any purpose. It is provided "as is" without express or implied warranty.

---

Updated Information/Additional Third Party Code Information available at <http://www.adobe.com/go/thirdparty> .

---

## 2.Adobe PostScript 3

Copyright 2007–2008 Adobe Systems Incorporated and its licensors. All rights reserved.

Portions include software under the following terms:

-----  
This product contains either BSAFE and/or TIPEM software by RSA Security Inc.

-----  
Portions of Pool.c\_Copyright 1987 – NeXT, Inc., and portions of Graphics.c\_Copyright 1988 NeXT, Inc. as an unpublished work. All Rights Reserved.

-----  
The Apache Software License, Version 1.1

This product includes software developed by the Apache Software Foundation (<http://www.apache.org/>).

Portions Copyright (c) 1998–2000 The Apache Software Foundation. All rights reserved.

Redistribution and use in source and binary forms, with or without modification, are permitted provided that the following conditions are met:

1. Redistributions of source code must retain the above copyright notice, this list of conditions and the following disclaimer.
2. Redistributions in binary form must reproduce the above copyright notice, this list of conditions and the following disclaimer in the documentation and/or other materials provided with the distribution.
3. The end–user documentation included with the redistribution, if any, must include the following acknowledgment:

"This product includes software developed by the Apache Software Foundation (<http://www.apache.org/>)."

Alternately, this acknowledgment may appear in the software itself, if and wherever such third–party acknowledgments normally appear.

4. The names "Xerces" and "Apache Software Foundation" must not be used to endorse or promote products derived from this software without prior written permission. For written permission, please contact [apache@apache.org](mailto:apache@apache.org).

5. Products derived from this software may not be called "Apache", nor may "Apache" appear in their name, without prior written permission of the Apache Software Foundation.

THIS SOFTWARE IS PROVIDED ``AS IS" AND ANY EXPRESSED OR IMPLIED WARRANTIES, INCLUDING,

BUT NOT LIMITED TO, THE IMPLIED WARRANTIES OF MERCHANTABILITY AND FITNESS FOR A PARTICULAR PURPOSE ARE DISCLAIMED. IN NO EVENT SHALL THE APACHE SOFTWARE FOUNDATION OR ITS CONTRIBUTORS BE LIABLE FOR ANY DIRECT, INDIRECT, INCIDENTAL, SPECIAL, EXEMPLARY, OR CONSEQUENTIAL DAMAGES (INCLUDING, BUT NOT LIMITED TO, PROCUREMENT OF SUBSTITUTE GOODS OR SERVICES; LOSS OF USE, DATA, OR PROFITS; OR BUSINESS INTERRUPTION) HOWEVER CAUSED AND ON ANY THEORY OF LIABILITY, WHETHER IN CONTRACT, STRICT LIABILITY, OR TORT (INCLUDING NEGLIGENCE OR OTHERWISE) ARISING IN ANY WAY OUT OF THE USE OF THIS SOFTWARE, EVEN IF ADVISED OF THE POSSIBILITY OF SUCH DAMAGE.

This software consists of voluntary contributions made by many individuals on behalf of the Apache Software Foundation and was originally based on software copyright (c) 1999, International Business Machines, Inc., <http://www.ibm.com>. For more information on the Apache Software Foundation, please see <http://www.apache.org/>.

-----  
This product includes software developed by the University of California, Berkeley and its contributors. Portions Copyright (c) 1990 The Regents of the University of California. All rights reserved.

Redistribution and use in source and binary forms, with or without modification, are permitted provided that the following conditions are met:

1. Redistributions of source code must retain the above copyright notice, this list of conditions and the following disclaimer.
2. Redistributions in binary form must reproduce the above copyright notice, this list of conditions and the following disclaimer in the documentation and/or other materials provided with the distribution.
3. All advertising materials mentioning features or use of this software must display the following acknowledgement:

This product includes software developed by the University of California, Berkeley and its contributors.

4. Neither the name of the University nor the names of its contributors may be used to endorse or promote products derived from this software without specific prior written permission.

THIS SOFTWARE IS PROVIDED BY THE REGENTS AND CONTRIBUTORS "AS IS" AND ANY EXPRESS OR IMPLIED WARRANTIES, INCLUDING, BUT NOT LIMITED TO, THE IMPLIED WARRANTIES OF MERCHANTABILITY AND FITNESS FOR A PARTICULAR PURPOSE ARE DISCLAIMED. IN NO EVENT SHALL THE REGENTS OR CONTRIBUTORS BE LIABLE FOR ANY DIRECT, INDIRECT, INCIDENTAL, SPECIAL, EXEMPLARY, OR CONSEQUENTIAL DAMAGES (INCLUDING, BUT NOT LIMITED TO, PROCUREMENT OF SUBSTITUTE GOODS OR SERVICES; LOSS OF USE, DATA, OR PROFITS; OR BUSINESS INTERRUPTION) HOWEVER CAUSED AND ON ANY THEORY OF LIABILITY, WHETHER IN CONTRACT, STRICT LIABILITY, OR TORT (INCLUDING NEGLIGENCE OR OTHERWISE) ARISING IN ANY WAY OUT OF THE USE OF THIS

SOFTWARE, EVEN IF ADVISED OF THE POSSIBILITY OF SUCH DAMAGE.

-----  
Portions Copyright (c) 1985, 1986 The Regents of the University of California. All rights reserved.

This code is derived from software contributed to Berkeley by James A. Woods, derived from original work by Spencer Thomas and Joseph Orost.

Redistribution and use in source and binary forms are permitted provided that the above copyright notice and this paragraph are duplicated in all such forms and that any documentation, advertising materials, and other materials related to such distribution and use acknowledge that the software was developed by the University of California, Berkeley. The name of the University may not be used to endorse or promote products derived from this software without specific prior written permission.

THIS SOFTWARE IS PROVIDED ``AS IS" AND WITHOUT ANY EXPRESS OR IMPLIED WARRANTIES, INCLUDING, WITHOUT LIMITATION, THE IMPLIED WARRANTIES OF MERCHANTABILITY AND FITNESS FOR A PARTICULAR PURPOSE.

Portions Copyright (c) 1993 X Consortium

Permission is hereby granted, free of charge, to any person obtaining a copy of this software and associated documentation files (the "Software"), to deal in the Software without restriction, including without limitation the rights to use, copy, modify, merge, publish, distribute, sublicense, and/or sell copies of the Software, and to permit persons to whom the Software is furnished to do so, subject to the following conditions:

The above copyright notice and this permission notice shall be included in all copies or substantial portions of the Software.

THE SOFTWARE IS PROVIDED "AS IS", WITHOUT WARRANTY OF ANY KIND, EXPRESS OR IMPLIED, INCLUDING BUT NOT LIMITED TO THE WARRANTIES OF MERCHANTABILITY, FITNESS FOR A PARTICULAR PURPOSE AND NONINFRINGEMENT. IN NO EVENT SHALL THE X CONSORTIUM BE LIABLE FOR ANY CLAIM, DAMAGES OR OTHER LIABILITY, WHETHER IN AN ACTION OF CONTRACT, TORT OR OTHERWISE, ARISING FROM, OUT OF OR IN CONNECTION WITH THE SOFTWARE OR THE USE OR OTHER DEALINGS IN THE SOFTWARE.

Except as contained in this notice, the name of the X Consortium shall not be used in advertising or otherwise to promote the sale, use or other dealings in this Software without prior written authorization from the X Consortium.

---

NOTICE REGARDING SABLOTRON

March 27, 2003

Portions of this product are based on Modifications created from the Original Code known as the "Sablotron XSLT Processor". The Sablotron XSLT Processor is subject to the Mozilla Public License Version 1.1 (the "License"). You may obtain a copy of the License at <http://www.mozilla.org/MPL/>

Software distributed under the License is distributed on an "AS IS" basis, WITHOUT WARRANTY OF ANY KIND, either express or implied. See the License for the specific language governing rights and limitations under the License.

The Original Code is the Sablotron XSLT Processor.

The Initial Developer of the Original Code is Ginger Alliance Ltd. Portions created by Ginger Alliance are Copyright (C) 2000 Ginger Alliance Ltd. All Rights Reserved.

Pursuant to sections 3.2 and 3.6 of the License, the Modifications created by Adobe Systems Incorporated are available as Source Code. The Modifications may be downloaded via the Internet from:

<http://partners.adobe.com/asn/tech/xml/sablotron/index.jsp>

The Original Code may be downloaded via the Internet from:

<https://sourceforge.net/projects/sablotron/>

---

This product includes software developed by the University of California, Berkeley and its contributors. Portions Copyright (c) 1982, 1986, 1987, 1988, 1989, 1990, 1991, 1992, 1993, 1994 The Regents of the University of California. All rights reserved.

Redistribution and use in source and binary forms, with or without modification, are permitted provided that the following conditions are met:

1. Redistributions of source code must retain the above copyright notice, this list of conditions and the following disclaimer.
2. Redistributions in binary form must reproduce the above copyright notice, this list of conditions



and the following disclaimer in the documentation and/or other materials provided with the distribution.

3. All advertising materials mentioning features or use of this software must display the following acknowledgement: This product includes software developed by the University of California, Berkeley and its contributors.

4. Neither the name of the University nor the names of its contributors may be used to endorse or promote products derived from this software without specific prior written permission.

THIS SOFTWARE IS PROVIDED BY THE REGENTS AND CONTRIBUTORS "AS IS" AND ANY EXPRESS OR IMPLIED WARRANTIES, INCLUDING, BUT NOT LIMITED TO, THE IMPLIED WARRANTIES OF MERCHANTABILITY AND FITNESS FOR A PARTICULAR PURPOSE ARE DISCLAIMED. IN NO EVENT SHALL THE REGENTS OR CONTRIBUTORS BE LIABLE FOR ANY DIRECT, INDIRECT, INCIDENTAL, SPECIAL, EXEMPLARY, OR CONSEQUENTIAL DAMAGES (INCLUDING, BUT NOT LIMITED TO, PROCUREMENT OF SUBSTITUTE GOODS OR SERVICES; LOSS OF USE, DATA, OR PROFITS; OR BUSINESS INTERRUPTION) HOWEVER CAUSED AND ON ANY THEORY OF LIABILITY, WHETHER IN CONTRACT, STRICT LIABILITY, OR TORT (INCLUDING NEGLIGENCE OR OTHERWISE) ARISING IN ANY WAY OUT OF THE USE OF THIS SOFTWARE, EVEN IF ADVISED OF THE POSSIBILITY OF SUCH DAMAGE.

---

Portions Copyright (c) 2001 by Andrei Alexandrescu. This code accompanies the book: Alexandrescu, Andrei. "Modern C++ Design: Generic Programming and Design Patterns Applied". Copyright (c) 2001. Addison-Wesley.

Permission to use, copy, modify, distribute and sell this software for any purpose is hereby granted without fee, provided that the above copyright notice appear in all copies and that both that copyright notice and this permission notice appear in supporting documentation. The author or Addison-Wesley Longman make no representations about the suitability of this software for any purpose. It is provided "as is" without express or implied warranty.

---

Portions developed by the University of California, Berkeley.

---

Portions Copyright © 1991–2005 Unicode, Inc. All rights reserved. Distributed under the Terms of Use in <http://www.unicode.org/copyright.html>.

Permission is hereby granted, free of charge, to any person obtaining a copy of the Unicode data files and associated documentation (the "Data Files") or Unicode software and associated documentation (the "Software") to deal in the Data Files or Software without restriction, including without limitation the rights to use, copy, modify, merge, publish, distribute, and/or sell copies of the Data Files or Software, and to permit persons to whom the Data Files or Software are furnished to do so, provided that (a) the above copyright notice(s) and this permission notice appear in all copies of the Data Files

or Software, (b) both the above copyright notice(s) and this permission notice appear in associated documentation, and (c) there is clear notice in each modified Data File or in the Software as well as in the documentation associated with the Data File(s) or Software that the data or software has been modified.

THE DATA FILES AND SOFTWARE ARE PROVIDED "AS IS", WITHOUT WARRANTY OF ANY KIND, EXPRESS OR IMPLIED, INCLUDING BUT NOT LIMITED TO THE WARRANTIES OF MERCHANTABILITY, FITNESS FOR A PARTICULAR PURPOSE AND NON-INFRINGEMENT OF THIRD PARTY RIGHTS. IN NO EVENT SHALL THE COPYRIGHT HOLDER OR HOLDERS INCLUDED IN THIS NOTICE BE LIABLE FOR ANY CLAIM, OR ANY SPECIAL INDIRECT OR CONSEQUENTIAL DAMAGES, OR ANY DAMAGES WHATSOEVER RESULTING FROM LOSS OF USE, DATA OR PROFITS, WHETHER IN AN ACTION OF CONTRACT, NEGLIGENCE OR OTHER TORTIOUS ACTION, ARISING OUT OF OR IN CONNECTION WITH THE USE OR PERFORMANCE OF THE DATA FILES OR SOFTWARE.

Except as contained in this notice, the name of a copyright holder shall not be used in advertising or otherwise to promote the sale, use or other dealings in these Data Files or Software without prior written authorization of the copyright holder.

Unicode and the Unicode logo are trademarks of Unicode, Inc., and may be registered in some jurisdictions. All other trademarks and registered trademarks mentioned herein are the property of their respective owners.

-----  
Adobe shall retain and reproduce, and require its Sublicensees to retain and reproduce JIM's following copyright notice within each copy of the licensed programs in any form, in whole or in part: "© 1981, 1990 JMI Consultants, Inc. All rights reserved."  
-----

This product includes software developed by the University of California, Berkeley and its contributors. Portions Copyright (c) 1990, 1993 The Regents of the University of California. All rights reserved.

This code is derived from software contributed to Berkeley by Chris Torek.

Redistribution and use in source and binary forms, with or without modification, are permitted provided that the following conditions are met:

1. Redistributions of source code must retain the above copyright notice, this list of conditions and the following disclaimer.
2. Redistributions in binary form must reproduce the above copyright notice, this list of conditions and the following disclaimer in the documentation and/or other materials provided with the distribution.

3. All advertising materials mentioning features or use of this software must display the following acknowledgement:

This product includes software developed by the University of California, Berkeley and its contributors.

4. Neither the name of the University nor the names of its contributors may be used to endorse or promote products derived from this software without specific prior written permission.

THIS SOFTWARE IS PROVIDED BY THE REGENTS AND CONTRIBUTORS "AS IS" AND ANY EXPRESS OR IMPLIED WARRANTIES, INCLUDING, BUT NOT LIMITED TO, THE IMPLIED WARRANTIES OF MERCHANTABILITY AND FITNESS FOR A PARTICULAR PURPOSE ARE DISCLAIMED. IN NO EVENT SHALL THE REGENTS OR CONTRIBUTORS BE LIABLE FOR ANY DIRECT, INDIRECT, INCIDENTAL, SPECIAL, EXEMPLARY, OR CONSEQUENTIAL DAMAGES (INCLUDING, BUT NOT LIMITED TO, PROCUREMENT OF SUBSTITUTE GOODS OR SERVICES; LOSS OF USE, DATA, OR PROFITS; OR BUSINESS INTERRUPTION) HOWEVER CAUSED AND ON ANY THEORY OF LIABILITY, WHETHER IN CONTRACT, STRICT LIABILITY, OR TORT (INCLUDING NEGLIGENCE OR OTHERWISE) ARISING IN ANY WAY OUT OF THE USE OF THIS SOFTWARE, EVEN IF ADVISED OF THE POSSIBILITY OF SUCH DAMAGE.

---

The Loki Library

Portions Copyright (c) 2001 by Andrei Alexandrescu // This code accompanies the book: Alexandrescu, Andrei. "Modern C++ Design: Generic Programming and Design Patterns Applied". Copyright (c) 2001. Addison-Wesley.

Permission to use, copy, modify, distribute and sell this software for any purpose is hereby granted without fee, provided that the above copyright notice appear in all copies and that both that copyright notice and this permission notice appear in supporting documentation. The author or Addison-Wesley Longman make no representations about the suitability of this software for any purpose. It is provided "as is" without express or implied warranty.

---

Updated Information/Additional Third Party Code Information available at <http://www.adobe.com/go/thirdparty> .

---

### 3. expat

Copyright (c) 1998, 1999, 2000 Thai Open Source Software Center Ltd  
and Clark Cooper

Copyright (c) 2001, 2002, 2003, 2004, 2005, 2006 Expat maintainers.

Permission is hereby granted, free of charge, to any person obtaining a copy of this software and associated documentation files (the "Software"), to deal in the Software without restriction, including without limitation the rights to use, copy, modify, merge, publish, distribute, sublicense, and/or sell copies of the Software, and to permit persons to whom the Software is furnished to do so, subject to the following conditions:

The above copyright notice and this permission notice shall be included in all copies or substantial portions of the Software.

THE SOFTWARE IS PROVIDED "AS IS", WITHOUT WARRANTY OF ANY KIND, EXPRESS OR IMPLIED, INCLUDING BUT NOT LIMITED TO THE WARRANTIES OF MERCHANTABILITY, FITNESS FOR A PARTICULAR PURPOSE AND NONINFRINGEMENT. IN NO EVENT SHALL THE AUTHORS OR COPYRIGHT HOLDERS BE LIABLE FOR ANY CLAIM, DAMAGES OR OTHER LIABILITY, WHETHER IN AN ACTION OF CONTRACT, TORT OR OTHERWISE, ARISING FROM, OUT OF OR IN CONNECTION WITH THE SOFTWARE OR THE USE OR OTHER DEALINGS IN THE SOFTWARE.

#### 4.HarfBuzz

Copyright (C) 2006 Behdad Esfahbod

Copyright (C) 1998–2004 David Turner and Werner Lemberg

Copyright (C) 2008 Nokia Corporation and/or its subsidiary(-ies)

Copyright (C) 2004,2007 Red Hat, Inc.

Permission is hereby granted, without written agreement and without license or royalty fees, to use, copy, modify, and distribute this software and its documentation for any purpose, provided that the above copyright notice and the following two paragraphs appear in all copies of this software.

IN NO EVENT SHALL THE COPYRIGHT HOLDER BE LIABLE TO ANY PARTY FOR DIRECT, INDIRECT, SPECIAL, INCIDENTAL, OR CONSEQUENTIAL DAMAGES ARISING OUT OF THE USE OF THIS SOFTWARE AND ITS DOCUMENTATION, EVEN IF THE COPYRIGHT HOLDER HAS BEEN ADVISED OF THE POSSIBILITY OF SUCH DAMAGE.

THE COPYRIGHT HOLDER SPECIFICALLY DISCLAIMS ANY WARRANTIES, INCLUDING, BUT NOT LIMITED TO, THE IMPLIED WARRANTIES OF MERCHANTABILITY AND FITNESS FOR A PARTICULAR PURPOSE. THE SOFTWARE PROVIDED HEREUNDER IS ON AN "AS IS" BASIS, AND THE COPYRIGHT HOLDER HAS NO OBLIGATION TO PROVIDE MAINTENANCE, SUPPORT, UPDATES, ENHANCEMENTS, OR MODIFICATIONS.

## 5. libjingle

Copyright 2004--2007, Google Inc.

Redistribution and use in source and binary forms, with or without modification, are permitted provided that the following conditions are met:

1. Redistributions of source code must retain the above copyright notice, this list of conditions and the following disclaimer.
2. Redistributions in binary form must reproduce the above copyright notice, this list of conditions and the following disclaimer in the documentation and/or other materials provided with the distribution.
3. The name of the author may not be used to endorse or promote products derived from this software without specific prior written permission.

THIS SOFTWARE IS PROVIDED BY THE AUTHOR ``AS IS" AND ANY EXPRESS OR IMPLIED WARRANTIES, INCLUDING, BUT NOT LIMITED TO, THE IMPLIED WARRANTIES OF MERCHANTABILITY AND FITNESS FOR A PARTICULAR PURPOSE ARE DISCLAIMED. IN NO EVENT SHALL THE AUTHOR BE LIABLE FOR ANY DIRECT, INDIRECT, INCIDENTAL, SPECIAL, EXEMPLARY, OR CONSEQUENTIAL DAMAGES (INCLUDING, BUT NOT LIMITED TO, PROCUREMENT OF SUBSTITUTE GOODS OR SERVICES; LOSS OF USE, DATA, OR PROFITS; OR BUSINESS INTERRUPTION) HOWEVER CAUSED AND ON ANY THEORY OF LIABILITY, WHETHER IN CONTRACT, STRICT LIABILITY, OR TORT (INCLUDING NEGLIGENCE OR OTHERWISE) ARISING IN ANY WAY OUT OF THE USE OF THIS SOFTWARE, EVEN IF ADVISED OF THE POSSIBILITY OF SUCH DAMAGE.

## 6. Lua

Copyright © 1994-2014 Lua.org, PUC-Rio.

Permission is hereby granted, free of charge, to any person obtaining a copy of this software and associated documentation files (the "Software"), to deal in the Software without restriction, including without limitation the rights to use, copy, modify, merge, publish, distribute, sublicense, and/or sell copies of the Software, and to permit persons to whom the Software is furnished to do so, subject to the following conditions:

The above copyright notice and this permission notice shall be included in all copies or substantial portions of the Software.

THE SOFTWARE IS PROVIDED "AS IS", WITHOUT WARRANTY OF ANY KIND, EXPRESS OR IMPLIED, INCLUDING BUT NOT LIMITED TO THE WARRANTIES OF MERCHANTABILITY, FITNESS FOR A PARTICULAR PURPOSE AND NONINFRINGEMENT. IN NO EVENT SHALL THE AUTHORS OR COPYRIGHT HOLDERS BE LIABLE FOR ANY CLAIM, DAMAGES OR OTHER LIABILITY, WHETHER IN AN ACTION OF CONTRACT, TORT OR OTHERWISE, ARISING FROM, OUT OF OR IN CONNECTION WITH THE SOFTWARE

OR THE USE OR OTHER DEALINGS IN THE SOFTWARE.

## 7. LuaSocket

LuaSocket 2.0.2 license

Copyright © 2004–2007 Diego Nehab

Permission is hereby granted, free of charge, to any person obtaining a copy of this software and associated documentation files (the "Software"), to deal in the Software without restriction, including without limitation the rights to use, copy, modify, merge, publish, distribute, sublicense, and/or sell copies of the Software, and to permit persons to whom the Software is furnished to do so, subject to the following conditions:

The above copyright notice and this permission notice shall be included in all copies or substantial portions of the Software.

THE SOFTWARE IS PROVIDED "AS IS", WITHOUT WARRANTY OF ANY KIND, EXPRESS OR IMPLIED, INCLUDING BUT NOT LIMITED TO THE WARRANTIES OF MERCHANTABILITY, FITNESS FOR A PARTICULAR PURPOSE AND NONINFRINGEMENT. IN NO EVENT SHALL THE AUTHORS OR COPYRIGHT HOLDERS BE LIABLE FOR ANY CLAIM, DAMAGES OR OTHER LIABILITY, WHETHER IN AN ACTION OF CONTRACT, TORT OR OTHERWISE, ARISING FROM, OUT OF OR IN CONNECTION WITH THE SOFTWARE OR THE USE OR OTHER DEALINGS IN THE SOFTWARE.



## 8. LuneScript

MIT License

LuneScript

Copyright (c) 2018–2020 ifritJP

Permission is hereby granted, free of charge, to any person obtaining a copy of this software and associated documentation files (the "Software"), to deal in the Software without restriction, including without limitation the rights to use, copy, modify, merge, publish, distribute, sublicense, and/or sell copies of the Software, and to permit persons to whom the Software is furnished to do so, subject to the following conditions:

The above copyright notice and this permission notice shall be included in all copies or substantial portions of the Software.

THE SOFTWARE IS PROVIDED "AS IS", WITHOUT WARRANTY OF ANY KIND, EXPRESS OR IMPLIED, INCLUDING BUT NOT LIMITED TO THE WARRANTIES OF MERCHANTABILITY, FITNESS FOR A PARTICULAR PURPOSE AND NONINFRINGEMENT. IN NO EVENT SHALL THE AUTHORS OR COPYRIGHT HOLDERS BE LIABLE FOR ANY CLAIM, DAMAGES OR OTHER LIABILITY, WHETHER IN AN ACTION OF CONTRACT, TORT OR OTHERWISE, ARISING FROM, OUT OF OR IN CONNECTION WITH THE SOFTWARE OR THE USE OR OTHER DEALINGS IN THE SOFTWARE.

## 9.MD4

"RSA Data Security, Inc. MD4 Message-Digest Algorithm"

"derived from the RSA Data Security, Inc. MD4 Message-Digest Algorithm"

## 10.Net-SNMP

Various copyrights apply to this package, listed in various separate parts below. Please make sure that you read all the parts.

----- Part 1: CMU/UCD copyright notice: (BSD like) -----

Copyright 1989, 1991, 1992 by Carnegie Mellon University

Derivative Work - 1996, 1998-2000

Copyright 1996, 1998-2000 The Regents of the University of California

All Rights Reserved

Permission to use, copy, modify and distribute this software and its documentation for any purpose and without fee is hereby granted, provided that the above copyright notice appears in all copies and that both that copyright notice and this permission notice appear in supporting documentation, and that the name of CMU and The Regents of the University of California not be used in advertising or publicity pertaining to distribution of the software without specific written permission.

CMU AND THE REGENTS OF THE UNIVERSITY OF CALIFORNIA DISCLAIM ALL WARRANTIES WITH REGARD TO THIS SOFTWARE, INCLUDING ALL IMPLIED WARRANTIES OF MERCHANTABILITY AND FITNESS. IN NO EVENT SHALL CMU OR THE REGENTS OF THE UNIVERSITY OF CALIFORNIA BE LIABLE FOR ANY SPECIAL, INDIRECT OR CONSEQUENTIAL DAMAGES OR ANY DAMAGES WHATSOEVER RESULTING FROM THE LOSS OF USE, DATA OR PROFITS, WHETHER IN AN ACTION OF CONTRACT, NEGLIGENCE OR OTHER TORTIOUS ACTION, ARISING OUT OF OR IN

CONNECTION WITH THE USE OR PERFORMANCE OF THIS SOFTWARE.

----- Part 2: Networks Associates Technology, Inc copyright notice (BSD) -----

Copyright (c) 2001–2003, Networks Associates Technology, Inc  
All rights reserved.

Redistribution and use in source and binary forms, with or without  
modification, are permitted provided that the following conditions are met:

- \* Redistributions of source code must retain the above copyright notice,  
this list of conditions and the following disclaimer.
- \* Redistributions in binary form must reproduce the above copyright  
notice, this list of conditions and the following disclaimer in the  
documentation and/or other materials provided with the distribution.
- \* Neither the name of the Networks Associates Technology, Inc nor the  
names of its contributors may be used to endorse or promote  
products derived from this software without specific prior written  
permission.

THIS SOFTWARE IS PROVIDED BY THE COPYRIGHT HOLDERS AND CONTRIBUTORS "AS IS" AND ANY EXPRESS OR IMPLIED WARRANTIES, INCLUDING, BUT NOT LIMITED TO, THE IMPLIED WARRANTIES OF MERCHANTABILITY AND FITNESS FOR A PARTICULAR PURPOSE ARE DISCLAIMED. IN NO EVENT SHALL THE COPYRIGHT HOLDERS OR CONTRIBUTORS BE LIABLE FOR ANY DIRECT, INDIRECT, INCIDENTAL, SPECIAL, EXEMPLARY, OR CONSEQUENTIAL DAMAGES (INCLUDING, BUT NOT LIMITED TO, PROCUREMENT OF SUBSTITUTE GOODS OR SERVICES; LOSS OF USE, DATA, OR PROFITS; OR BUSINESS INTERRUPTION) HOWEVER CAUSED AND ON ANY THEORY OF LIABILITY, WHETHER IN CONTRACT, STRICT LIABILITY, OR TORT (INCLUDING NEGLIGENCE OR OTHERWISE) ARISING IN ANY WAY OUT OF THE USE OF THIS SOFTWARE, EVEN IF ADVISED OF THE POSSIBILITY OF SUCH DAMAGE.

----- Part 3: Cambridge Broadband Ltd. copyright notice (BSD) -----

Portions of this code are copyright (c) 2001–2003, Cambridge Broadband Ltd.

All rights reserved.

Redistribution and use in source and binary forms, with or without modification, are permitted provided that the following conditions are met:

- \* Redistributions of source code must retain the above copyright notice, this list of conditions and the following disclaimer.
- \* Redistributions in binary form must reproduce the above copyright notice, this list of conditions and the following disclaimer in the documentation and/or other materials provided with the distribution.
- \* The name of Cambridge Broadband Ltd. may not be used to endorse or promote products derived from this software without specific prior written permission.

THIS SOFTWARE IS PROVIDED BY THE COPYRIGHT HOLDER "AS IS" AND ANY EXPRESS OR IMPLIED WARRANTIES, INCLUDING, BUT NOT LIMITED TO, THE IMPLIED WARRANTIES OF MERCHANTABILITY AND FITNESS FOR A PARTICULAR PURPOSE ARE DISCLAIMED. IN NO EVENT SHALL THE COPYRIGHT HOLDER BE LIABLE FOR ANY DIRECT, INDIRECT, INCIDENTAL, SPECIAL, EXEMPLARY, OR CONSEQUENTIAL DAMAGES (INCLUDING, BUT NOT LIMITED TO, PROCUREMENT OF SUBSTITUTE GOODS OR SERVICES; LOSS OF USE, DATA, OR PROFITS; OR BUSINESS INTERRUPTION) HOWEVER CAUSED AND ON ANY THEORY OF LIABILITY, WHETHER IN CONTRACT, STRICT LIABILITY, OR TORT (INCLUDING NEGLIGENCE OR OTHERWISE) ARISING IN ANY WAY OUT OF THE USE OF THIS SOFTWARE, EVEN IF ADVISED OF THE POSSIBILITY OF SUCH DAMAGE.

----- Part 4: Sun Microsystems, Inc. copyright notice (BSD) -----

Copyright (c) 2003 Sun Microsystems, Inc., 4150 Network Circle, Santa Clara, California 95054, U.S.A. All rights reserved.

Use is subject to license terms below.

This distribution may include materials developed by third parties.

Sun, Sun Microsystems, the Sun logo and Solaris are trademarks or registered trademarks of Sun Microsystems, Inc. in the U.S. and other countries.

Redistribution and use in source and binary forms, with or without modification, are permitted provided that the following conditions are met:

- \* Redistributions of source code must retain the above copyright notice, this list of conditions and the following disclaimer.
- \* Redistributions in binary form must reproduce the above copyright notice, this list of conditions and the following disclaimer in the documentation and/or other materials provided with the distribution.
- \* Neither the name of the Sun Microsystems, Inc. nor the names of its contributors may be used to endorse or promote products derived from this software without specific prior written permission.

THIS SOFTWARE IS PROVIDED BY THE COPYRIGHT HOLDERS AND CONTRIBUTORS "AS IS" AND ANY EXPRESS OR IMPLIED WARRANTIES, INCLUDING, BUT NOT LIMITED TO, THE IMPLIED WARRANTIES OF MERCHANTABILITY AND FITNESS FOR A PARTICULAR PURPOSE ARE DISCLAIMED. IN NO EVENT SHALL THE COPYRIGHT HOLDERS OR CONTRIBUTORS BE LIABLE FOR ANY DIRECT, INDIRECT, INCIDENTAL, SPECIAL, EXEMPLARY, OR CONSEQUENTIAL DAMAGES (INCLUDING, BUT NOT LIMITED TO, PROCUREMENT OF SUBSTITUTE GOODS OR SERVICES; LOSS OF USE, DATA, OR PROFITS; OR BUSINESS INTERRUPTION) HOWEVER CAUSED AND ON ANY THEORY OF LIABILITY, WHETHER IN CONTRACT, STRICT LIABILITY, OR TORT (INCLUDING NEGLIGENCE OR OTHERWISE) ARISING IN ANY WAY OUT OF THE USE OF THIS SOFTWARE, EVEN IF ADVISED OF THE POSSIBILITY OF SUCH DAMAGE.

----- Part 5: Sparta, Inc copyright notice (BSD) -----

Copyright (c) 2003-2013, Sparta, Inc  
All rights reserved.

Redistribution and use in source and binary forms, with or without modification, are permitted provided that the following conditions are met:

- \* Redistributions of source code must retain the above copyright notice, this list of conditions and the following disclaimer.
- \* Redistributions in binary form must reproduce the above copyright notice, this list of conditions and the following disclaimer in the documentation and/or other materials provided with the distribution.
- \* Neither the name of Sparta, Inc nor the names of its contributors may be used to endorse or promote products derived from this software without specific prior written permission.

THIS SOFTWARE IS PROVIDED BY THE COPYRIGHT HOLDERS AND CONTRIBUTORS "AS IS" AND ANY EXPRESS OR IMPLIED WARRANTIES, INCLUDING, BUT NOT LIMITED TO, THE IMPLIED WARRANTIES OF MERCHANTABILITY AND FITNESS FOR A PARTICULAR PURPOSE ARE DISCLAIMED. IN NO EVENT SHALL THE COPYRIGHT HOLDERS OR CONTRIBUTORS BE LIABLE FOR ANY DIRECT, INDIRECT, INCIDENTAL, SPECIAL, EXEMPLARY, OR CONSEQUENTIAL DAMAGES (INCLUDING, BUT NOT LIMITED TO, PROCUREMENT OF SUBSTITUTE GOODS OR SERVICES; LOSS OF USE, DATA, OR PROFITS; OR BUSINESS INTERRUPTION) HOWEVER CAUSED AND ON ANY THEORY OF LIABILITY, WHETHER IN CONTRACT, STRICT LIABILITY, OR TORT (INCLUDING NEGLIGENCE OR OTHERWISE) ARISING IN ANY WAY OUT OF THE USE OF THIS SOFTWARE, EVEN IF ADVISED OF THE POSSIBILITY OF SUCH DAMAGE.

----- Part 6: Cisco/BUPTNIC copyright notice (BSD) -----

Copyright (c) 2004, Cisco, Inc and Information Network  
Center of Beijing University of Posts and Telecommunications.  
All rights reserved.

Redistribution and use in source and binary forms, with or without modification, are permitted provided that the following conditions are met:

- \* Redistributions of source code must retain the above copyright notice, this list of conditions and the following disclaimer.
- \* Redistributions in binary form must reproduce the above copyright notice, this list of conditions and the following disclaimer in the documentation and/or other materials provided with the distribution.

- \* Neither the name of Cisco, Inc, Beijing University of Posts and Telecommunications, nor the names of their contributors may be used to endorse or promote products derived from this software without specific prior written permission.

THIS SOFTWARE IS PROVIDED BY THE COPYRIGHT HOLDERS AND CONTRIBUTORS "AS IS" AND ANY EXPRESS OR IMPLIED WARRANTIES, INCLUDING, BUT NOT LIMITED TO, THE IMPLIED WARRANTIES OF MERCHANTABILITY AND FITNESS FOR A PARTICULAR PURPOSE ARE DISCLAIMED. IN NO EVENT SHALL THE COPYRIGHT HOLDERS OR CONTRIBUTORS BE LIABLE FOR ANY DIRECT, INDIRECT, INCIDENTAL, SPECIAL, EXEMPLARY, OR CONSEQUENTIAL DAMAGES (INCLUDING, BUT NOT LIMITED TO, PROCUREMENT OF SUBSTITUTE GOODS OR SERVICES; LOSS OF USE, DATA, OR PROFITS; OR BUSINESS INTERRUPTION) HOWEVER CAUSED AND ON ANY THEORY OF LIABILITY, WHETHER IN CONTRACT, STRICT LIABILITY, OR TORT (INCLUDING NEGLIGENCE OR OTHERWISE) ARISING IN ANY WAY OUT OF THE USE OF THIS SOFTWARE, EVEN IF ADVISED OF THE POSSIBILITY OF SUCH DAMAGE.

----- Part 7: Fabasoft R&D Software GmbH & Co KG copyright notice (BSD) -----

Copyright (c) Fabasoft R&D Software GmbH & Co KG, 2003  
oss@fabasoft.com  
Author: Bernhard Penz <bernhard.penz@fabasoft.com>

Redistribution and use in source and binary forms, with or without modification, are permitted provided that the following conditions are met:

- \* Redistributions of source code must retain the above copyright notice, this list of conditions and the following disclaimer.
- \* Redistributions in binary form must reproduce the above copyright notice, this list of conditions and the following disclaimer in the documentation and/or other materials provided with the distribution.
- \* The name of Fabasoft R&D Software GmbH & Co KG or any of its subsidiaries, brand or product names may not be used to endorse or promote products derived from this software without specific prior written permission.

THIS SOFTWARE IS PROVIDED BY THE COPYRIGHT HOLDER "AS IS" AND ANY EXPRESS OR IMPLIED WARRANTIES, INCLUDING, BUT NOT LIMITED TO, THE IMPLIED WARRANTIES OF MERCHANTABILITY AND FITNESS FOR A PARTICULAR PURPOSE ARE DISCLAIMED. IN NO EVENT SHALL THE COPYRIGHT HOLDER BE LIABLE FOR ANY DIRECT, INDIRECT, INCIDENTAL, SPECIAL, EXEMPLARY, OR CONSEQUENTIAL DAMAGES (INCLUDING, BUT NOT LIMITED TO, PROCUREMENT OF SUBSTITUTE GOODS OR SERVICES; LOSS OF USE, DATA, OR PROFITS; OR BUSINESS INTERRUPTION) HOWEVER CAUSED AND ON ANY THEORY OF LIABILITY, WHETHER IN CONTRACT, STRICT LIABILITY, OR TORT (INCLUDING NEGLIGENCE OR OTHERWISE) ARISING IN ANY WAY OUT OF THE USE OF THIS SOFTWARE, EVEN IF ADVISED OF THE POSSIBILITY OF SUCH DAMAGE.

----- Part 8: Apple Inc. copyright notice (BSD) -----

Copyright (c) 2007 Apple Inc. All rights reserved.

Redistribution and use in source and binary forms, with or without modification, are permitted provided that the following conditions are met:

1. Redistributions of source code must retain the above copyright notice, this list of conditions and the following disclaimer.
2. Redistributions in binary form must reproduce the above copyright notice, this list of conditions and the following disclaimer in the documentation and/or other materials provided with the distribution.
3. Neither the name of Apple Inc. ("Apple") nor the names of its contributors may be used to endorse or promote products derived from this software without specific prior written permission.

THIS SOFTWARE IS PROVIDED BY APPLE AND ITS CONTRIBUTORS "AS IS" AND ANY EXPRESS OR IMPLIED WARRANTIES, INCLUDING, BUT NOT LIMITED TO, THE IMPLIED WARRANTIES OF MERCHANTABILITY AND FITNESS FOR A PARTICULAR PURPOSE ARE DISCLAIMED. IN NO EVENT SHALL APPLE OR ITS CONTRIBUTORS BE LIABLE FOR ANY DIRECT, INDIRECT, INCIDENTAL, SPECIAL, EXEMPLARY, OR CONSEQUENTIAL DAMAGES (INCLUDING, BUT NOT LIMITED TO, PROCUREMENT OF SUBSTITUTE GOODS OR SERVICES; LOSS OF USE, DATA, OR PROFITS; OR BUSINESS INTERRUPTION) HOWEVER CAUSED AND



ON ANY THEORY OF LIABILITY, WHETHER IN CONTRACT, STRICT LIABILITY, OR TORT (INCLUDING NEGLIGENCE OR OTHERWISE) ARISING IN ANY WAY OUT OF THE USE OF THIS SOFTWARE, EVEN IF ADVISED OF THE POSSIBILITY OF SUCH DAMAGE.

----- Part 9: ScienceLogic, LLC copyright notice (BSD) -----

Copyright (c) 2009, ScienceLogic, LLC  
All rights reserved.

Redistribution and use in source and binary forms, with or without modification, are permitted provided that the following conditions are met:

- \* Redistributions of source code must retain the above copyright notice, this list of conditions and the following disclaimer.
- \* Redistributions in binary form must reproduce the above copyright notice, this list of conditions and the following disclaimer in the documentation and/or other materials provided with the distribution.
- \* Neither the name of ScienceLogic, LLC nor the names of its contributors may be used to endorse or promote products derived from this software without specific prior written permission.

THIS SOFTWARE IS PROVIDED BY THE COPYRIGHT HOLDERS AND CONTRIBUTORS ``AS IS'' AND ANY EXPRESS OR IMPLIED WARRANTIES, INCLUDING, BUT NOT LIMITED TO, THE IMPLIED WARRANTIES OF MERCHANTABILITY AND FITNESS FOR A PARTICULAR PURPOSE ARE DISCLAIMED. IN NO EVENT SHALL THE COPYRIGHT HOLDERS OR CONTRIBUTORS BE LIABLE FOR ANY DIRECT, INDIRECT, INCIDENTAL, SPECIAL, EXEMPLARY, OR CONSEQUENTIAL DAMAGES (INCLUDING, BUT NOT LIMITED TO, PROCUREMENT OF SUBSTITUTE GOODS OR SERVICES; LOSS OF USE, DATA, OR PROFITS; OR BUSINESS INTERRUPTION) HOWEVER CAUSED AND ON ANY THEORY OF LIABILITY, WHETHER IN CONTRACT, STRICT LIABILITY, OR TORT (INCLUDING NEGLIGENCE OR OTHERWISE) ARISING IN ANY WAY OUT OF THE USE OF THIS SOFTWARE, EVEN IF ADVISED OF THE POSSIBILITY OF SUCH DAMAGE.

----- Part 10: Lennart Poettering copyright notice (BSD-like) -----

Copyright 2010 Lennart Poettering

Permission is hereby granted, free of charge, to any person obtaining a copy of this software and associated documentation files (the "Software"), to deal in the Software without restriction, including without limitation the rights to use, copy, modify, merge, publish, distribute, sublicense, and/or sell copies of the Software, and to permit persons to whom the Software is furnished to do so, subject to the following conditions:

The above copyright notice and this permission notice shall be included in all copies or substantial portions of the Software.

THE SOFTWARE IS PROVIDED "AS IS", WITHOUT WARRANTY OF ANY KIND, EXPRESS OR IMPLIED, INCLUDING BUT NOT LIMITED TO THE WARRANTIES OF MERCHANTABILITY, FITNESS FOR A PARTICULAR PURPOSE AND NONINFRINGEMENT. IN NO EVENT SHALL THE AUTHORS OR COPYRIGHT HOLDERS BE LIABLE FOR ANY CLAIM, DAMAGES OR OTHER LIABILITY, WHETHER IN AN ACTION OF CONTRACT, TORT OR OTHERWISE, ARISING FROM, OUT OF OR IN CONNECTION WITH THE SOFTWARE OR THE USE OR OTHER DEALINGS IN THE SOFTWARE.

----- Part 11: IETF copyright notice (BSD) -----

Copyright (c) 2013 IETF Trust and the persons identified as authors of the code. All rights reserved.

Redistribution and use in source and binary forms, with or without modification, are permitted provided that the following conditions are met:

- \* Redistributions of source code must retain the above copyright notice, this list of conditions and the following disclaimer.
- \* Redistributions in binary form must reproduce the above copyright notice, this list of conditions and the following disclaimer in the

documentation and/or other materials provided with the distribution.

\* Neither the name of Internet Society, IETF or IETF Trust, nor the names of specific contributors, may be used to endorse or promote products derived from this software without specific prior written permission.

THIS SOFTWARE IS PROVIDED BY THE COPYRIGHT HOLDERS AND CONTRIBUTORS "AS IS" AND ANY EXPRESS OR IMPLIED WARRANTIES, INCLUDING, BUT NOT LIMITED TO, THE IMPLIED WARRANTIES OF MERCHANTABILITY AND FITNESS FOR A PARTICULAR PURPOSE ARE DISCLAIMED. IN NO EVENT SHALL THE COPYRIGHT OWNER OR CONTRIBUTORS BE LIABLE FOR ANY DIRECT, INDIRECT, INCIDENTAL, SPECIAL, EXEMPLARY, OR CONSEQUENTIAL DAMAGES (INCLUDING, BUT NOT LIMITED TO, PROCUREMENT OF SUBSTITUTE GOODS OR SERVICES; LOSS OF USE, DATA, OR PROFITS; OR BUSINESS INTERRUPTION) HOWEVER CAUSED AND ON ANY THEORY OF LIABILITY, WHETHER IN CONTRACT, STRICT LIABILITY, OR TORT (INCLUDING NEGLIGENCE OR OTHERWISE) ARISING IN ANY WAY OUT OF THE USE OF THIS SOFTWARE, EVEN IF ADVISED OF THE POSSIBILITY OF SUCH DAMAGE.

----- Part 12: Arista Networks copyright notice (BSD) -----

Copyright (c) 2013, Arista Networks, Inc.

All rights reserved.

Redistribution and use in source and binary forms, with or without modification, are permitted provided that the following conditions are met:

- \* Redistributions of source code must retain the above copyright notice, this list of conditions and the following disclaimer.
- \* Redistributions in binary form must reproduce the above copyright notice, this list of conditions and the following disclaimer in the documentation and/or other materials provided with the distribution.
- \* Neither the name of Arista Networks, Inc. nor the names of its contributors may be used to endorse or promote products derived from this software without specific prior written permission.

THIS SOFTWARE IS PROVIDED BY THE COPYRIGHT HOLDERS AND CONTRIBUTORS  
`AS IS" AND ANY EXPRESS OR IMPLIED WARRANTIES, INCLUDING, BUT NOT  
LIMITED TO, THE IMPLIED WARRANTIES OF MERCHANTABILITY AND FITNESS FOR  
A PARTICULAR PURPOSE ARE DISCLAIMED. IN NO EVENT SHALL THE COPYRIGHT  
HOLDERS OR CONTRIBUTORS BE LIABLE FOR ANY DIRECT, INDIRECT,  
INCIDENTAL, SPECIAL, EXEMPLARY, OR CONSEQUENTIAL DAMAGES (INCLUDING,  
BUT NOT LIMITED TO, PROCUREMENT OF SUBSTITUTE GOODS OR SERVICES; LOSS  
OF USE, DATA, OR PROFITS; OR BUSINESS INTERRUPTION) HOWEVER CAUSED AND  
ON ANY THEORY OF LIABILITY, WHETHER IN CONTRACT, STRICT LIABILITY, OR  
TORT (INCLUDING NEGLIGENCE OR OTHERWISE) ARISING IN ANY WAY OUT OF THE  
USE OF THIS SOFTWARE, EVEN IF ADVISED OF THE POSSIBILITY OF SUCH  
DAMAGE.

----- Part 13: VMware, Inc. copyright notice (BSD) -----

Copyright (c) 2016, VMware, Inc.

All rights reserved.

Redistribution and use in source and binary forms, with or without  
modification, are permitted provided that the following conditions are met:

- \* Redistributions of source code must retain the above copyright notice,  
this list of conditions and the following disclaimer.
- \* Redistributions in binary form must reproduce the above copyright  
notice, this list of conditions and the following disclaimer in the  
documentation and/or other materials provided with the distribution.
- \* Neither the name of VMware, Inc. nor the names of its contributors  
may be used to endorse or promote products derived from this software  
without specific prior written permission.

THIS SOFTWARE IS PROVIDED BY THE COPYRIGHT HOLDERS AND CONTRIBUTORS `AS  
IS" AND ANY EXPRESS OR IMPLIED WARRANTIES, INCLUDING, BUT NOT LIMITED TO,  
THE IMPLIED WARRANTIES OF MERCHANTABILITY AND FITNESS FOR A PARTICULAR  
PURPOSE ARE DISCLAIMED. IN NO EVENT SHALL THE COPYRIGHT HOLDERS OR  
CONTRIBUTORS BE LIABLE FOR ANY DIRECT, INDIRECT, INCIDENTAL, SPECIAL,

EXEMPLARY, OR CONSEQUENTIAL DAMAGES (INCLUDING, BUT NOT LIMITED TO, PROCUREMENT OF SUBSTITUTE GOODS OR SERVICES; LOSS OF USE, DATA, OR PROFITS; OR BUSINESS INTERRUPTION) HOWEVER CAUSED AND ON ANY THEORY OF LIABILITY, WHETHER IN CONTRACT, STRICT LIABILITY, OR TORT (INCLUDING NEGLIGENCE OR OTHERWISE) ARISING IN ANY WAY OUT OF THE USE OF THIS SOFTWARE, EVEN IF ADVISED OF THE POSSIBILITY OF SUCH DAMAGE.

----- Part 14: USC/Information Sciences Institute copyright notice (BSD) -----

Copyright (c) 2017–2018, Information Sciences Institute  
All rights reserved.

Redistribution and use in source and binary forms, with or without modification, are permitted provided that the following conditions are met:

- \* Redistributions of source code must retain the above copyright notice, this list of conditions and the following disclaimer.
- \* Redistributions in binary form must reproduce the above copyright notice, this list of conditions and the following disclaimer in the documentation and/or other materials provided with the distribution.
- \* Neither the name of Information Sciences Institute nor the names of its contributors may be used to endorse or promote products derived from this software without specific prior written permission.

THIS SOFTWARE IS PROVIDED BY THE COPYRIGHT HOLDERS AND CONTRIBUTORS "AS IS" AND ANY EXPRESS OR IMPLIED WARRANTIES, INCLUDING, BUT NOT LIMITED TO, THE IMPLIED WARRANTIES OF MERCHANTABILITY AND FITNESS FOR A PARTICULAR PURPOSE ARE DISCLAIMED. IN NO EVENT SHALL THE COPYRIGHT HOLDERS OR CONTRIBUTORS BE LIABLE FOR ANY DIRECT, INDIRECT, INCIDENTAL, SPECIAL, EXEMPLARY, OR CONSEQUENTIAL DAMAGES (INCLUDING, BUT NOT LIMITED TO, PROCUREMENT OF SUBSTITUTE GOODS OR SERVICES; LOSS OF USE, DATA, OR PROFITS; OR BUSINESS INTERRUPTION) HOWEVER CAUSED AND ON ANY THEORY OF LIABILITY, WHETHER IN CONTRACT, STRICT LIABILITY, OR TORT (INCLUDING NEGLIGENCE OR OTHERWISE) ARISING IN ANY WAY OUT OF THE USE OF THIS SOFTWARE, EVEN IF ADVISED OF THE POSSIBILITY OF SUCH DAMAGE.

Various copyrights apply to this package, listed in various separate parts below. Please make sure that you read all the parts.

----- Part 1: CMU/UCD copyright notice: (BSD like) -----

Copyright 1989, 1991, 1992 by Carnegie Mellon University

Derivative Work - 1996, 1998-2000

Copyright 1996, 1998-2000 The Regents of the University of California

All Rights Reserved

Permission to use, copy, modify and distribute this software and its documentation for any purpose and without fee is hereby granted, provided that the above copyright notice appears in all copies and that both that copyright notice and this permission notice appear in supporting documentation, and that the name of CMU and The Regents of the University of California not be used in advertising or publicity pertaining to distribution of the software without specific written permission.

CMU AND THE REGENTS OF THE UNIVERSITY OF CALIFORNIA DISCLAIM ALL WARRANTIES WITH REGARD TO THIS SOFTWARE, INCLUDING ALL IMPLIED WARRANTIES OF MERCHANTABILITY AND FITNESS. IN NO EVENT SHALL CMU OR THE REGENTS OF THE UNIVERSITY OF CALIFORNIA BE LIABLE FOR ANY SPECIAL, INDIRECT OR CONSEQUENTIAL DAMAGES OR ANY DAMAGES WHATSOEVER RESULTING FROM THE LOSS OF USE, DATA OR PROFITS, WHETHER IN AN ACTION OF CONTRACT, NEGLIGENCE OR OTHER TORTIOUS ACTION, ARISING OUT OF OR IN CONNECTION WITH THE USE OR PERFORMANCE OF THIS SOFTWARE.

----- Part 2: Networks Associates Technology, Inc copyright notice (BSD) -----

Copyright (c) 2001-2003, Networks Associates Technology, Inc  
All rights reserved.

Redistribution and use in source and binary forms, with or without modification, are permitted provided that the following conditions are met:

- \* Redistributions of source code must retain the above copyright notice, this list of conditions and the following disclaimer.
- \* Redistributions in binary form must reproduce the above copyright notice, this list of conditions and the following disclaimer in the documentation and/or other materials provided with the distribution.
- \* Neither the name of the Networks Associates Technology, Inc nor the names of its contributors may be used to endorse or promote products derived from this software without specific prior written permission.

THIS SOFTWARE IS PROVIDED BY THE COPYRIGHT HOLDERS AND CONTRIBUTORS "AS IS" AND ANY EXPRESS OR IMPLIED WARRANTIES, INCLUDING, BUT NOT LIMITED TO, THE IMPLIED WARRANTIES OF MERCHANTABILITY AND FITNESS FOR A PARTICULAR PURPOSE ARE DISCLAIMED. IN NO EVENT SHALL THE COPYRIGHT HOLDERS OR CONTRIBUTORS BE LIABLE FOR ANY DIRECT, INDIRECT, INCIDENTAL, SPECIAL, EXEMPLARY, OR CONSEQUENTIAL DAMAGES (INCLUDING, BUT NOT LIMITED TO, PROCUREMENT OF SUBSTITUTE GOODS OR SERVICES; LOSS OF USE, DATA, OR PROFITS; OR BUSINESS INTERRUPTION) HOWEVER CAUSED AND ON ANY THEORY OF LIABILITY, WHETHER IN CONTRACT, STRICT LIABILITY, OR TORT (INCLUDING NEGLIGENCE OR OTHERWISE) ARISING IN ANY WAY OUT OF THE USE OF THIS SOFTWARE, EVEN IF ADVISED OF THE POSSIBILITY OF SUCH DAMAGE.

----- Part 3: Cambridge Broadband Ltd. copyright notice (BSD) -----

Portions of this code are copyright (c) 2001–2003, Cambridge Broadband Ltd.  
All rights reserved.

Redistribution and use in source and binary forms, with or without modification, are permitted provided that the following conditions are met:

- \* Redistributions of source code must retain the above copyright notice, this list of conditions and the following disclaimer.

- \* Redistributions in binary form must reproduce the above copyright notice, this list of conditions and the following disclaimer in the documentation and/or other materials provided with the distribution.
- \* The name of Cambridge Broadband Ltd. may not be used to endorse or promote products derived from this software without specific prior written permission.

THIS SOFTWARE IS PROVIDED BY THE COPYRIGHT HOLDER "AS IS" AND ANY EXPRESS OR IMPLIED WARRANTIES, INCLUDING, BUT NOT LIMITED TO, THE IMPLIED WARRANTIES OF MERCHANTABILITY AND FITNESS FOR A PARTICULAR PURPOSE ARE DISCLAIMED. IN NO EVENT SHALL THE COPYRIGHT HOLDER BE LIABLE FOR ANY DIRECT, INDIRECT, INCIDENTAL, SPECIAL, EXEMPLARY, OR CONSEQUENTIAL DAMAGES (INCLUDING, BUT NOT LIMITED TO, PROCUREMENT OF SUBSTITUTE GOODS OR SERVICES; LOSS OF USE, DATA, OR PROFITS; OR BUSINESS INTERRUPTION) HOWEVER CAUSED AND ON ANY THEORY OF LIABILITY, WHETHER IN CONTRACT, STRICT LIABILITY, OR TORT (INCLUDING NEGLIGENCE OR OTHERWISE) ARISING IN ANY WAY OUT OF THE USE OF THIS SOFTWARE, EVEN IF ADVISED OF THE POSSIBILITY OF SUCH DAMAGE.

----- Part 4: Sun Microsystems, Inc. copyright notice (BSD) -----

Copyright © 2003 Sun Microsystems, Inc., 4150 Network Circle, Santa Clara, California 95054, U.S.A. All rights reserved.

Use is subject to license terms below.

This distribution may include materials developed by third parties.

Sun, Sun Microsystems, the Sun logo and Solaris are trademarks or registered trademarks of Sun Microsystems, Inc. in the U.S. and other countries.

Redistribution and use in source and binary forms, with or without modification, are permitted provided that the following conditions are met:

- \* Redistributions of source code must retain the above copyright notice, this list of conditions and the following disclaimer.



- \* Redistributions in binary form must reproduce the above copyright notice, this list of conditions and the following disclaimer in the documentation and/or other materials provided with the distribution.
- \* Neither the name of the Sun Microsystems, Inc. nor the names of its contributors may be used to endorse or promote products derived from this software without specific prior written permission.

THIS SOFTWARE IS PROVIDED BY THE COPYRIGHT HOLDERS AND CONTRIBUTORS "AS IS" AND ANY EXPRESS OR IMPLIED WARRANTIES, INCLUDING, BUT NOT LIMITED TO, THE IMPLIED WARRANTIES OF MERCHANTABILITY AND FITNESS FOR A PARTICULAR PURPOSE ARE DISCLAIMED. IN NO EVENT SHALL THE COPYRIGHT HOLDERS OR CONTRIBUTORS BE LIABLE FOR ANY DIRECT, INDIRECT, INCIDENTAL, SPECIAL, EXEMPLARY, OR CONSEQUENTIAL DAMAGES (INCLUDING, BUT NOT LIMITED TO, PROCUREMENT OF SUBSTITUTE GOODS OR SERVICES; LOSS OF USE, DATA, OR PROFITS; OR BUSINESS INTERRUPTION) HOWEVER CAUSED AND ON ANY THEORY OF LIABILITY, WHETHER IN CONTRACT, STRICT LIABILITY, OR TORT (INCLUDING NEGLIGENCE OR OTHERWISE) ARISING IN ANY WAY OUT OF THE USE OF THIS SOFTWARE, EVEN IF ADVISED OF THE POSSIBILITY OF SUCH DAMAGE.

----- Part 5: Sparta, Inc copyright notice (BSD) -----

Copyright (c) 2003-2012, Sparta, Inc  
 All rights reserved.

Redistribution and use in source and binary forms, with or without modification, are permitted provided that the following conditions are met:

- \* Redistributions of source code must retain the above copyright notice, this list of conditions and the following disclaimer.
- \* Redistributions in binary form must reproduce the above copyright notice, this list of conditions and the following disclaimer in the documentation and/or other materials provided with the distribution.
- \* Neither the name of Sparta, Inc nor the names of its contributors may

be used to endorse or promote products derived from this software without specific prior written permission.

THIS SOFTWARE IS PROVIDED BY THE COPYRIGHT HOLDERS AND CONTRIBUTORS "AS IS" AND ANY EXPRESS OR IMPLIED WARRANTIES, INCLUDING, BUT NOT LIMITED TO, THE IMPLIED WARRANTIES OF MERCHANTABILITY AND FITNESS FOR A PARTICULAR PURPOSE ARE DISCLAIMED. IN NO EVENT SHALL THE COPYRIGHT HOLDERS OR CONTRIBUTORS BE LIABLE FOR ANY DIRECT, INDIRECT, INCIDENTAL, SPECIAL, EXEMPLARY, OR CONSEQUENTIAL DAMAGES (INCLUDING, BUT NOT LIMITED TO, PROCUREMENT OF SUBSTITUTE GOODS OR SERVICES; LOSS OF USE, DATA, OR PROFITS; OR BUSINESS INTERRUPTION) HOWEVER CAUSED AND ON ANY THEORY OF LIABILITY, WHETHER IN CONTRACT, STRICT LIABILITY, OR TORT (INCLUDING NEGLIGENCE OR OTHERWISE) ARISING IN ANY WAY OUT OF THE USE OF THIS SOFTWARE, EVEN IF ADVISED OF THE POSSIBILITY OF SUCH DAMAGE.

----- Part 6: Cisco/BUPTNIC copyright notice (BSD) -----

Copyright (c) 2004, Cisco, Inc and Information Network  
Center of Beijing University of Posts and Telecommunications.  
All rights reserved.

Redistribution and use in source and binary forms, with or without modification, are permitted provided that the following conditions are met:

- \* Redistributions of source code must retain the above copyright notice, this list of conditions and the following disclaimer.
- \* Redistributions in binary form must reproduce the above copyright notice, this list of conditions and the following disclaimer in the documentation and/or other materials provided with the distribution.
- \* Neither the name of Cisco, Inc, Beijing University of Posts and Telecommunications, nor the names of their contributors may be used to endorse or promote products derived from this software without specific prior written permission.

THIS SOFTWARE IS PROVIDED BY THE COPYRIGHT HOLDERS AND CONTRIBUTORS "AS IS" AND ANY EXPRESS OR IMPLIED WARRANTIES, INCLUDING, BUT NOT LIMITED TO,

THE IMPLIED WARRANTIES OF MERCHANTABILITY AND FITNESS FOR A PARTICULAR PURPOSE ARE DISCLAIMED. IN NO EVENT SHALL THE COPYRIGHT HOLDERS OR CONTRIBUTORS BE LIABLE FOR ANY DIRECT, INDIRECT, INCIDENTAL, SPECIAL, EXEMPLARY, OR CONSEQUENTIAL DAMAGES (INCLUDING, BUT NOT LIMITED TO, PROCUREMENT OF SUBSTITUTE GOODS OR SERVICES; LOSS OF USE, DATA, OR PROFITS; OR BUSINESS INTERRUPTION) HOWEVER CAUSED AND ON ANY THEORY OF LIABILITY, WHETHER IN CONTRACT, STRICT LIABILITY, OR TORT (INCLUDING NEGLIGENCE OR OTHERWISE) ARISING IN ANY WAY OUT OF THE USE OF THIS SOFTWARE, EVEN IF ADVISED OF THE POSSIBILITY OF SUCH DAMAGE.

----- Part 7: Fabasoft R&D Software GmbH & Co KG copyright notice (BSD) -----

Copyright (c) Fabasoft R&D Software GmbH & Co KG, 2003

oss@fabasoft.com

Author: Bernhard Penz <bernhard.penz@fabasoft.com>

Redistribution and use in source and binary forms, with or without modification, are permitted provided that the following conditions are met:

- \* Redistributions of source code must retain the above copyright notice, this list of conditions and the following disclaimer.
- \* Redistributions in binary form must reproduce the above copyright notice, this list of conditions and the following disclaimer in the documentation and/or other materials provided with the distribution.
- \* The name of Fabasoft R&D Software GmbH & Co KG or any of its subsidiaries, brand or product names may not be used to endorse or promote products derived from this software without specific prior written permission.

THIS SOFTWARE IS PROVIDED BY THE COPYRIGHT HOLDER "AS IS" AND ANY EXPRESS OR IMPLIED WARRANTIES, INCLUDING, BUT NOT LIMITED TO, THE IMPLIED WARRANTIES OF MERCHANTABILITY AND FITNESS FOR A PARTICULAR PURPOSE ARE DISCLAIMED. IN NO EVENT SHALL THE COPYRIGHT HOLDER BE LIABLE FOR ANY DIRECT, INDIRECT, INCIDENTAL, SPECIAL, EXEMPLARY, OR CONSEQUENTIAL DAMAGES (INCLUDING, BUT NOT LIMITED TO, PROCUREMENT OF SUBSTITUTE GOODS OR SERVICES; LOSS OF USE, DATA, OR PROFITS; OR BUSINESS INTERRUPTION) HOWEVER CAUSED AND ON ANY THEORY OF LIABILITY,

WHETHER IN CONTRACT, STRICT LIABILITY, OR TORT (INCLUDING NEGLIGENCE OR OTHERWISE) ARISING IN ANY WAY OUT OF THE USE OF THIS SOFTWARE, EVEN IF ADVISED OF THE POSSIBILITY OF SUCH DAMAGE.

----- Part 8: Apple Inc. copyright notice (BSD) -----

Copyright (c) 2007 Apple Inc. All rights reserved.

Redistribution and use in source and binary forms, with or without modification, are permitted provided that the following conditions are met:

1. Redistributions of source code must retain the above copyright notice, this list of conditions and the following disclaimer.
2. Redistributions in binary form must reproduce the above copyright notice, this list of conditions and the following disclaimer in the documentation and/or other materials provided with the distribution.
3. Neither the name of Apple Inc. ("Apple") nor the names of its contributors may be used to endorse or promote products derived from this software without specific prior written permission.

THIS SOFTWARE IS PROVIDED BY APPLE AND ITS CONTRIBUTORS "AS IS" AND ANY EXPRESS OR IMPLIED WARRANTIES, INCLUDING, BUT NOT LIMITED TO, THE IMPLIED WARRANTIES OF MERCHANTABILITY AND FITNESS FOR A PARTICULAR PURPOSE ARE DISCLAIMED. IN NO EVENT SHALL APPLE OR ITS CONTRIBUTORS BE LIABLE FOR ANY DIRECT, INDIRECT, INCIDENTAL, SPECIAL, EXEMPLARY, OR CONSEQUENTIAL DAMAGES (INCLUDING, BUT NOT LIMITED TO, PROCUREMENT OF SUBSTITUTE GOODS OR SERVICES; LOSS OF USE, DATA, OR PROFITS; OR BUSINESS INTERRUPTION) HOWEVER CAUSED AND ON ANY THEORY OF LIABILITY, WHETHER IN CONTRACT, STRICT LIABILITY, OR TORT (INCLUDING NEGLIGENCE OR OTHERWISE) ARISING IN ANY WAY OUT OF THE USE OF THIS SOFTWARE, EVEN IF ADVISED OF THE POSSIBILITY OF SUCH DAMAGE.

----- Part 9: ScienceLogic, LLC copyright notice (BSD) -----

Copyright (c) 2009, ScienceLogic, LLC

All rights reserved.

Redistribution and use in source and binary forms, with or without modification, are permitted provided that the following conditions are met:

- \* Redistributions of source code must retain the above copyright notice, this list of conditions and the following disclaimer.
- \* Redistributions in binary form must reproduce the above copyright notice, this list of conditions and the following disclaimer in the documentation and/or other materials provided with the distribution.
- \* Neither the name of ScienceLogic, LLC nor the names of its contributors may be used to endorse or promote products derived from this software without specific prior written permission.

THIS SOFTWARE IS PROVIDED BY THE COPYRIGHT HOLDERS AND CONTRIBUTORS ``AS IS'' AND ANY EXPRESS OR IMPLIED WARRANTIES, INCLUDING, BUT NOT LIMITED TO, THE IMPLIED WARRANTIES OF MERCHANTABILITY AND FITNESS FOR A PARTICULAR PURPOSE ARE DISCLAIMED. IN NO EVENT SHALL THE COPYRIGHT HOLDERS OR CONTRIBUTORS BE LIABLE FOR ANY DIRECT, INDIRECT, INCIDENTAL, SPECIAL, EXEMPLARY, OR CONSEQUENTIAL DAMAGES (INCLUDING, BUT NOT LIMITED TO, PROCUREMENT OF SUBSTITUTE GOODS OR SERVICES; LOSS OF USE, DATA, OR PROFITS; OR BUSINESS INTERRUPTION) HOWEVER CAUSED AND ON ANY THEORY OF LIABILITY, WHETHER IN CONTRACT, STRICT LIABILITY, OR TORT (INCLUDING NEGLIGENCE OR OTHERWISE) ARISING IN ANY WAY OUT OF THE USE OF THIS SOFTWARE, EVEN IF ADVISED OF THE POSSIBILITY OF SUCH DAMAGE.

## 11. OpenSSL

### OpenSSL License

-----

/\*

=====  
=====

\* Copyright (c) 1998-2018 The OpenSSL Project. All rights reserved.

\*

\* Redistribution and use in source and binary forms, with or without  
\* modification, are permitted provided that the following conditions  
\* are met:

\*

\* 1. Redistributions of source code must retain the above copyright  
\* notice, this list of conditions and the following disclaimer.

\*

\* 2. Redistributions in binary form must reproduce the above copyright  
\* notice, this list of conditions and the following disclaimer in  
\* the documentation and/or other materials provided with the  
\* distribution.

\*

\* 3. All advertising materials mentioning features or use of this  
\* software must display the following acknowledgment:  
\* "This product includes software developed by the OpenSSL Project  
\* for use in the OpenSSL Toolkit. (<http://www.openssl.org/>)"

\*

\* 4. The names "OpenSSL Toolkit" and "OpenSSL Project" must not be used to  
\* endorse or promote products derived from this software without  
\* prior written permission. For written permission, please contact  
\* [openssl-core@openssl.org](mailto:openssl-core@openssl.org).

\*

\* 5. Products derived from this software may not be called "OpenSSL"  
\* nor may "OpenSSL" appear in their names without prior written  
\* permission of the OpenSSL Project.

\*

\* 6. Redistributions of any form whatsoever must retain the following

\* acknowledgment:  
\* "This product includes software developed by the OpenSSL Project  
\* for use in the OpenSSL Toolkit (<http://www.openssl.org/>)"  
\*  
\* THIS SOFTWARE IS PROVIDED BY THE OpenSSL PROJECT ``AS IS'' AND ANY  
\* EXPRESSED OR IMPLIED WARRANTIES, INCLUDING, BUT NOT LIMITED TO, THE  
\* IMPLIED WARRANTIES OF MERCHANTABILITY AND FITNESS FOR A PARTICULAR  
\* PURPOSE ARE DISCLAIMED. IN NO EVENT SHALL THE OpenSSL PROJECT OR  
\* ITS CONTRIBUTORS BE LIABLE FOR ANY DIRECT, INDIRECT, INCIDENTAL,  
\* SPECIAL, EXEMPLARY, OR CONSEQUENTIAL DAMAGES (INCLUDING, BUT  
\* NOT LIMITED TO, PROCUREMENT OF SUBSTITUTE GOODS OR SERVICES;  
\* LOSS OF USE, DATA, OR PROFITS; OR BUSINESS INTERRUPTION)  
\* HOWEVER CAUSED AND ON ANY THEORY OF LIABILITY, WHETHER IN CONTRACT,  
\* STRICT LIABILITY, OR TORT (INCLUDING NEGLIGENCE OR OTHERWISE)  
\* ARISING IN ANY WAY OUT OF THE USE OF THIS SOFTWARE, EVEN IF ADVISED  
\* OF THE POSSIBILITY OF SUCH DAMAGE.

=====  
=====

\* This product includes cryptographic software written by Eric Young  
\* (eay@cryptsoft.com). This product includes software written by Tim  
\* Hudson (tjh@cryptsoft.com).

\*/

Original SSLeay License  
-----

/\* Copyright (C) 1995-1998 Eric Young (eay@cryptsoft.com)  
\* All rights reserved.  
\*  
\* This package is an SSL implementation written  
\* by Eric Young (eay@cryptsoft.com).  
\* The implementation was written so as to conform with Netscapes SSL.  
\*  
\* This library is free for commercial and non-commercial use as long as  
\* the following conditions are aheared to. The following conditions

\* apply to all code found in this distribution, be it the RC4, RSA,  
 \* lhash, DES, etc., code; not just the SSL code. The SSL documentation  
 \* included with this distribution is covered by the same copyright terms  
 \* except that the holder is Tim Hudson (tjh@cryptsoft.com).  
 \*

\* Copyright remains Eric Young's, and as such any Copyright notices in  
 \* the code are not to be removed.

\* If this package is used in a product, Eric Young should be given attribution  
 \* as the author of the parts of the library used.

\* This can be in the form of a textual message at program startup or  
 \* in documentation (online or textual) provided with the package.  
 \*

\* Redistribution and use in source and binary forms, with or without  
 \* modification, are permitted provided that the following conditions  
 \* are met:

\* 1. Redistributions of source code must retain the copyright  
 \* notice, this list of conditions and the following disclaimer.

\* 2. Redistributions in binary form must reproduce the above copyright  
 \* notice, this list of conditions and the following disclaimer in the  
 \* documentation and/or other materials provided with the distribution.

\* 3. All advertising materials mentioning features or use of this software  
 \* must display the following acknowledgement:  
 \* "This product includes cryptographic software written by  
 \* Eric Young (eay@cryptsoft.com)"  
 \* The word 'cryptographic' can be left out if the routines from the library  
 \* being used are not cryptographic related :-).

\* 4. If you include any Windows specific code (or a derivative thereof) from  
 \* the apps directory (application code) you must include an acknowledgement:  
 \* "This product includes software written by Tim Hudson (tjh@cryptsoft.com)"  
 \*

\* THIS SOFTWARE IS PROVIDED BY ERIC YOUNG `AS IS" AND  
 \* ANY EXPRESS OR IMPLIED WARRANTIES, INCLUDING, BUT NOT LIMITED TO, THE  
 \* IMPLIED WARRANTIES OF MERCHANTABILITY AND FITNESS FOR A PARTICULAR PURPOSE  
 \* ARE DISCLAIMED. IN NO EVENT SHALL THE AUTHOR OR CONTRIBUTORS BE LIABLE  
 \* FOR ANY DIRECT, INDIRECT, INCIDENTAL, SPECIAL, EXEMPLARY, OR CONSEQUENTIAL  
 \* DAMAGES (INCLUDING, BUT NOT LIMITED TO, PROCUREMENT OF SUBSTITUTE GOODS  
 \* OR SERVICES; LOSS OF USE, DATA, OR PROFITS; OR BUSINESS INTERRUPTION)  
 \* HOWEVER CAUSED AND ON ANY THEORY OF LIABILITY, WHETHER IN CONTRACT, STRICT



\* LIABILITY, OR TORT (INCLUDING NEGLIGENCE OR OTHERWISE) ARISING IN ANY WAY  
\* OUT OF THE USE OF THIS SOFTWARE, EVEN IF ADVISED OF THE POSSIBILITY OF  
\* SUCH DAMAGE.  
\*  
\* The licence and distribution terms for any publically available version or  
\* derivative of this code cannot be changed. i.e. this code cannot simply be  
\* copied and put under another distribution licence  
\* [including the GNU Public Licence.]  
\*/

## OpenSSL License

-----

/\*

=====  
=====

\* Copyright (c) 1998-2011 The OpenSSL Project. All rights reserved.

\*

\* Redistribution and use in source and binary forms, with or without  
\* modification, are permitted provided that the following conditions  
\* are met:

\*

\* 1. Redistributions of source code must retain the above copyright  
\* notice, this list of conditions and the following disclaimer.

\*

\* 2. Redistributions in binary form must reproduce the above copyright  
\* notice, this list of conditions and the following disclaimer in  
\* the documentation and/or other materials provided with the  
\* distribution.

\*

\* 3. All advertising materials mentioning features or use of this  
\* software must display the following acknowledgment:  
\* "This product includes software developed by the OpenSSL Project  
\* for use in the OpenSSL Toolkit. (<http://www.openssl.org/>)"

\*

\* 4. The names "OpenSSL Toolkit" and "OpenSSL Project" must not be used to  
\* endorse or promote products derived from this software without  
\* prior written permission. For written permission, please contact  
\* [openssl-core@openssl.org](mailto:openssl-core@openssl.org).

\*

\* 5. Products derived from this software may not be called "OpenSSL"  
\* nor may "OpenSSL" appear in their names without prior written  
\* permission of the OpenSSL Project.

\*

\* 6. Redistributions of any form whatsoever must retain the following  
\* acknowledgment:

\* "This product includes software developed by the OpenSSL Project  
\* for use in the OpenSSL Toolkit (<http://www.openssl.org/>)"

\*  
\* THIS SOFTWARE IS PROVIDED BY THE OpenSSL PROJECT ``AS IS" AND ANY  
\* EXPRESSED OR IMPLIED WARRANTIES, INCLUDING, BUT NOT LIMITED TO, THE  
\* IMPLIED WARRANTIES OF MERCHANTABILITY AND FITNESS FOR A PARTICULAR  
\* PURPOSE ARE DISCLAIMED. IN NO EVENT SHALL THE OpenSSL PROJECT OR  
\* ITS CONTRIBUTORS BE LIABLE FOR ANY DIRECT, INDIRECT, INCIDENTAL,  
\* SPECIAL, EXEMPLARY, OR CONSEQUENTIAL DAMAGES (INCLUDING, BUT  
\* NOT LIMITED TO, PROCUREMENT OF SUBSTITUTE GOODS OR SERVICES;  
\* LOSS OF USE, DATA, OR PROFITS; OR BUSINESS INTERRUPTION)  
\* HOWEVER CAUSED AND ON ANY THEORY OF LIABILITY, WHETHER IN CONTRACT,  
\* STRICT LIABILITY, OR TORT (INCLUDING NEGLIGENCE OR OTHERWISE)  
\* ARISING IN ANY WAY OUT OF THE USE OF THIS SOFTWARE, EVEN IF ADVISED  
\* OF THE POSSIBILITY OF SUCH DAMAGE.

=====  
=====

\*  
\* This product includes cryptographic software written by Eric Young  
\* (eay@cryptsoft.com). This product includes software written by Tim  
\* Hudson (tjh@cryptsoft.com).  
\*  
\*/

Original SSLeay License  
-----

/\* Copyright (C) 1995-1998 Eric Young (eay@cryptsoft.com)  
\* All rights reserved.  
\*  
\* This package is an SSL implementation written  
\* by Eric Young (eay@cryptsoft.com).  
\* The implementation was written so as to conform with Netscapes SSL.  
\*  
\* This library is free for commercial and non-commercial use as long as  
\* the following conditions are aheared to. The following conditions  
\* apply to all code found in this distribution, be it the RC4, RSA,  
\* lhash, DES, etc., code; not just the SSL code. The SSL documentation  
\* included with this distribution is covered by the same copyright terms

\* except that the holder is Tim Hudson (tjh@cryptsoft.com).

\*

\* Copyright remains Eric Young's, and as such any Copyright notices in  
 \* the code are not to be removed.

\* If this package is used in a product, Eric Young should be given attribution  
 \* as the author of the parts of the library used.

\* This can be in the form of a textual message at program startup or  
 \* in documentation (online or textual) provided with the package.

\*

\* Redistribution and use in source and binary forms, with or without  
 \* modification, are permitted provided that the following conditions  
 \* are met:

\* 1. Redistributions of source code must retain the copyright  
 \* notice, this list of conditions and the following disclaimer.

\* 2. Redistributions in binary form must reproduce the above copyright  
 \* notice, this list of conditions and the following disclaimer in the  
 \* documentation and/or other materials provided with the distribution.

\* 3. All advertising materials mentioning features or use of this software  
 \* must display the following acknowledgement:  
 \* "This product includes cryptographic software written by  
 \* Eric Young (eay@cryptsoft.com)"  
 \* The word 'cryptographic' can be left out if the routines from the library  
 \* being used are not cryptographic related :-).

\* 4. If you include any Windows specific code (or a derivative thereof) from  
 \* the apps directory (application code) you must include an acknowledgement:  
 \* "This product includes software written by Tim Hudson (tjh@cryptsoft.com)"

\*

\* THIS SOFTWARE IS PROVIDED BY ERIC YOUNG ``AS IS" AND  
 \* ANY EXPRESS OR IMPLIED WARRANTIES, INCLUDING, BUT NOT LIMITED TO, THE  
 \* IMPLIED WARRANTIES OF MERCHANTABILITY AND FITNESS FOR A PARTICULAR PURPOSE  
 \* ARE DISCLAIMED. IN NO EVENT SHALL THE AUTHOR OR CONTRIBUTORS BE LIABLE  
 \* FOR ANY DIRECT, INDIRECT, INCIDENTAL, SPECIAL, EXEMPLARY, OR CONSEQUENTIAL  
 \* DAMAGES (INCLUDING, BUT NOT LIMITED TO, PROCUREMENT OF SUBSTITUTE GOODS  
 \* OR SERVICES; LOSS OF USE, DATA, OR PROFITS; OR BUSINESS INTERRUPTION)  
 \* HOWEVER CAUSED AND ON ANY THEORY OF LIABILITY, WHETHER IN CONTRACT, STRICT  
 \* LIABILITY, OR TORT (INCLUDING NEGLIGENCE OR OTHERWISE) ARISING IN ANY WAY  
 \* OUT OF THE USE OF THIS SOFTWARE, EVEN IF ADVISED OF THE POSSIBILITY OF  
 \* SUCH DAMAGE.

\*

\* The licence and distribution terms for any publically available version or  
\* derivative of this code cannot be changed. i.e. this code cannot simply be  
\* copied and put under another distribution licence  
\* [including the GNU Public Licence.]

\*/