

LCD display

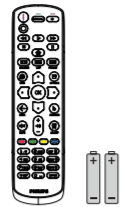

Remote Control and AAA Batteries



Quick start guide



Power Cord

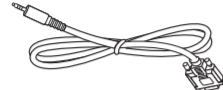

RS232 Cable

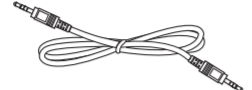

RS232 Daisy Chain Cable



IR Sensor Cable



USB Cover



AC Switch Cover



Cable Clip x 3PCS



Philips logo plate

* Differences according to regions.

Display design and accessories may differ from those illustrated above.

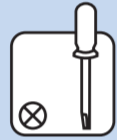

1

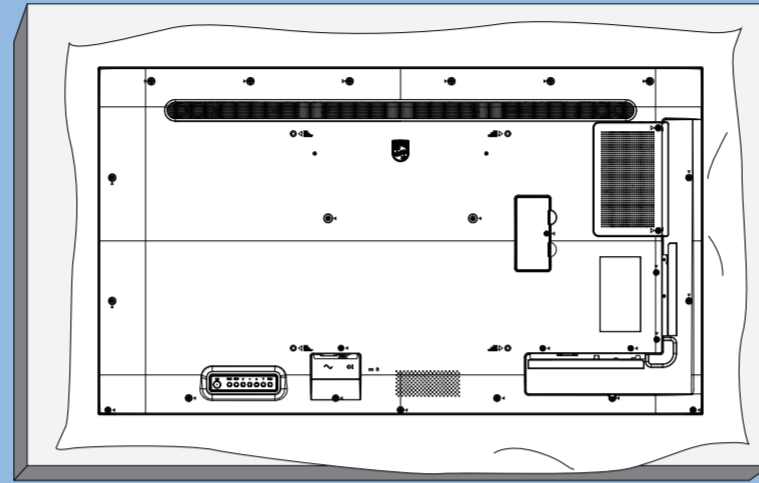

2

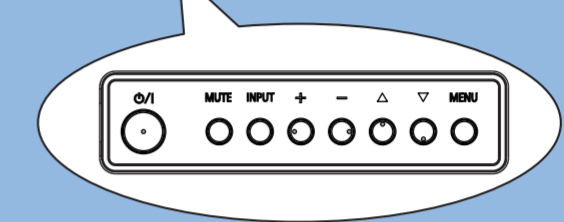
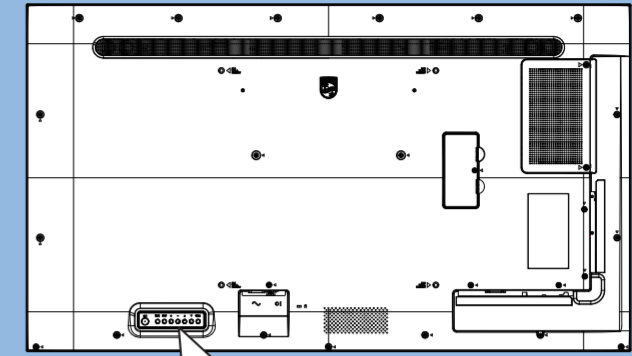

3

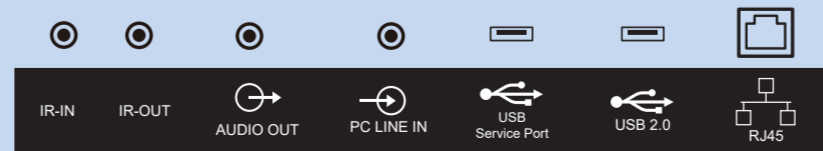
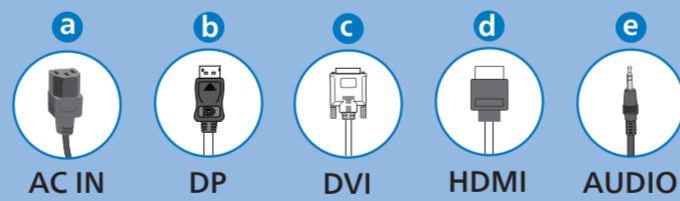
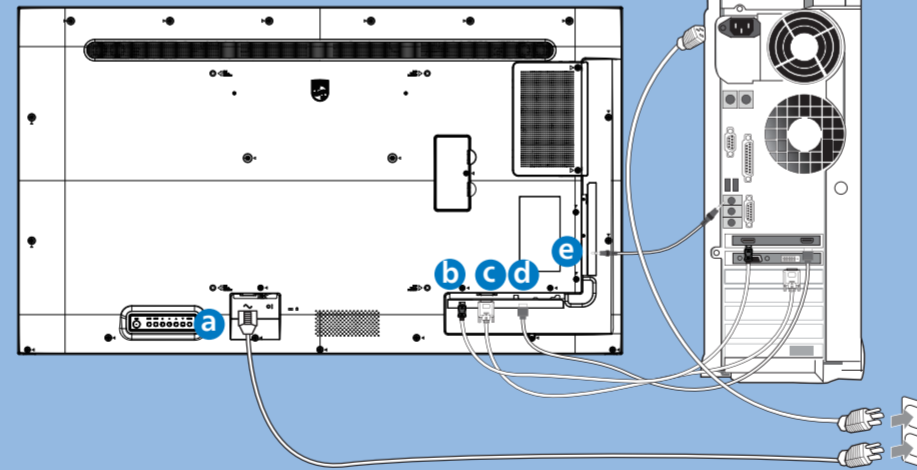
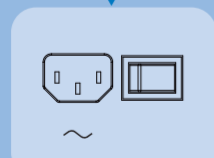
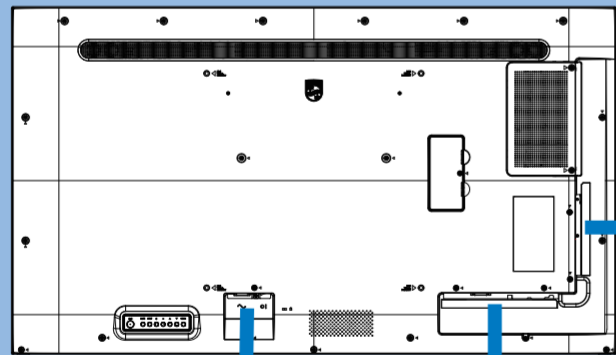

4

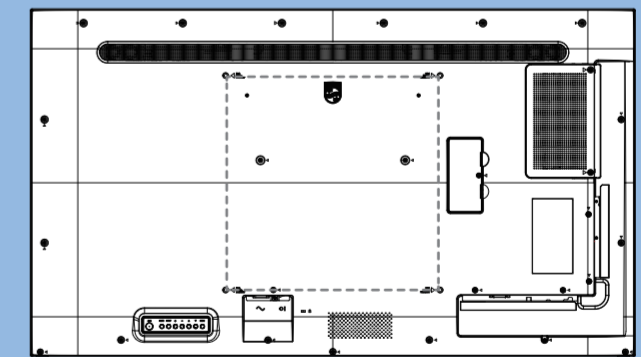

M6 * (10+X) mm
(X=Thickness of Wall mount BKT)

43BDL4511D: 200mmx200mm
50BDL4511D: 400mmx400mm
55BDL4511D: 400mmx400mm

5

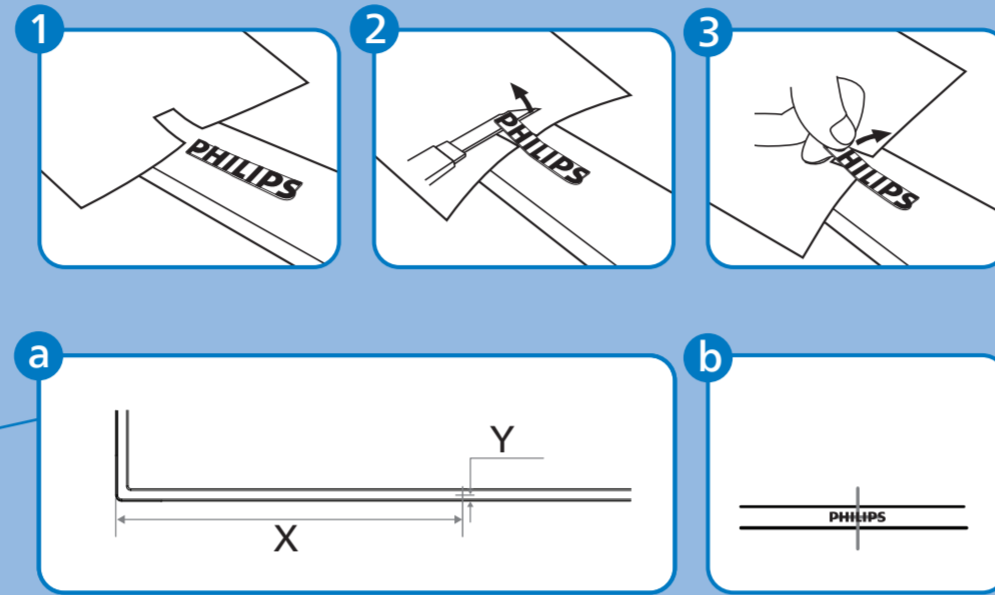
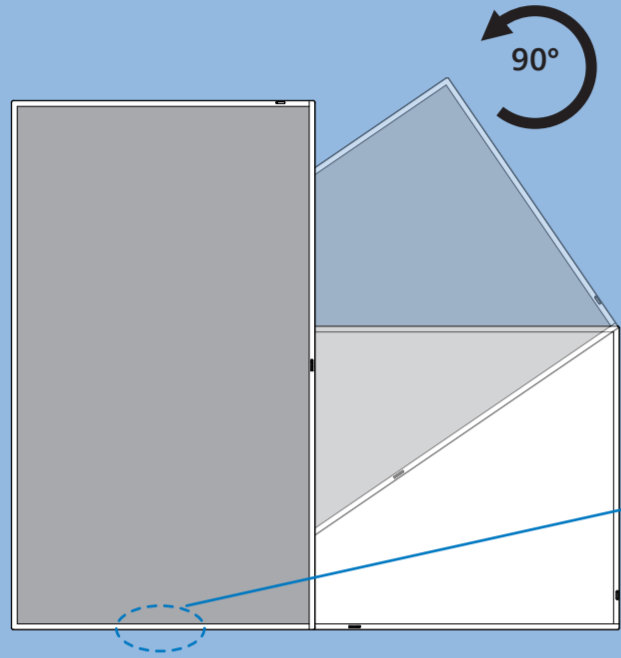

43BDL4511D: X=280.6mm Y=7.4mm
 50BDL4511D: X=324.5mm Y=7.9mm
 55BDL4511D: X=356.3mm Y=7.4mm

PHILIPS

Professional Display Solutions

D Line

43BDL4511D/50BDL4511D
55BDL4511D

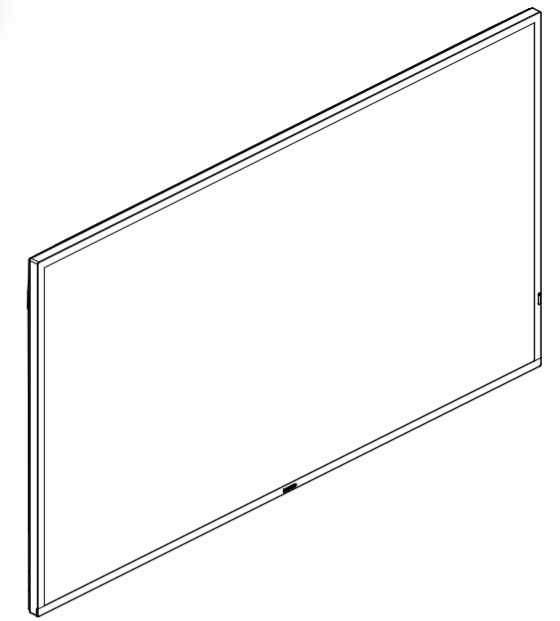

Quick Start



Please check out the website below for more product information.
www.philips.com/signagesolutions-support



Envision Peripherals Inc.
 490 N McCarthy Blvd, Suite #120
 Milpitas, CA 95035
 USA

2021 © TOP Victory Investments Ltd. All rights reserved.
 This product has been manufactured by and is sold under the responsibility of Top Victory Investments Ltd., and Top Victory Investments Ltd. is the warrantor in relation to this product. Philips and the Philips Shield Emblem are registered trademarks of Koninklijke Philips N.V. and are used under license.

Specifications are subject to change without notice.

Version: V1.00 2021-09-06



Q41G50M181318A