

EPOS

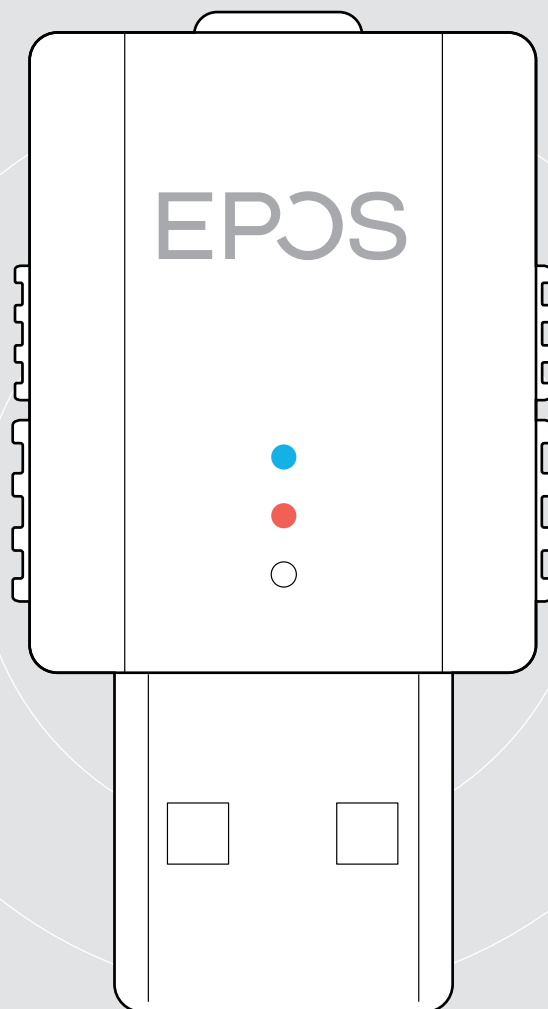

SDW D1 USB

DECT dongle for IMPACT 5000 Series headsets

User Guide

Contents

Important DECT information	2
Package contents.....	3
SDW D1 USB dongle	3
Bundles with headset, carry pouch and charging cable.....	3
Product overview.....	4
Overview of the SDW D1 USB dongle	4
Overview of the headsets.....	4
Overview of the LEDs.....	6
Preparing dongle and headset for use	7
Charging the headset before first use.....	7
Installing software	7
Connecting the dongle to a computer.....	8
Pairing the headset and the dongle.....	8
Assembling and wearing the headset SDW 10 HS	9
Using the headset with the headband.....	9
Using the headset with the ear hook.....	10
Using the headset with the neckband	12
Detaching headband, ear hook or neckband	14
Adjusting and wearing the headset SDW 30 HS SDW 60 HS	15
Labeling the headset	16
Setting up and using the headset.....	17
Switching the headset on.....	17
Switching the headset off.....	17
Adjusting the volume	18
Muting the headset's microphone.....	19
Making calls.....	20
Making / ending a call.....	20
Handling a call	20
Redialing*	21
Managing a second call – second softphone	21
Additional functions.....	22
Verifying battery life	22
Charging the headset.....	22
If you leave the DECT range	23
Reconnecting the headset	23
Enabling / disabling voice prompts.....	23
Switching between DECT dongle and base station	24
Cleaning and maintaining the headset system.....	25
Replacing the ear pads.....	25
Replacing / removing the headset's rechargeable battery.....	26
Updating the firmware of the products.....	26
If a problem occurs	27
Specifications.....	28

Important DECT information

CAUTION

Danger of malfunctions!

This DECT dongle uses restricted wireless radio frequencies which vary by country. DECT products should never be used outside the region/country in which they were originally purchased and intended to be used. If used in unauthorized countries, it is a violation of law, may disrupt telecommunications networks and devices and can subject you to fines and penalties by regulatory agencies.

- ▷ Only use the product in environments where wireless transmission is permitted.
- ▷ Before putting the product into operation, please observe the respective country-specific regulations!

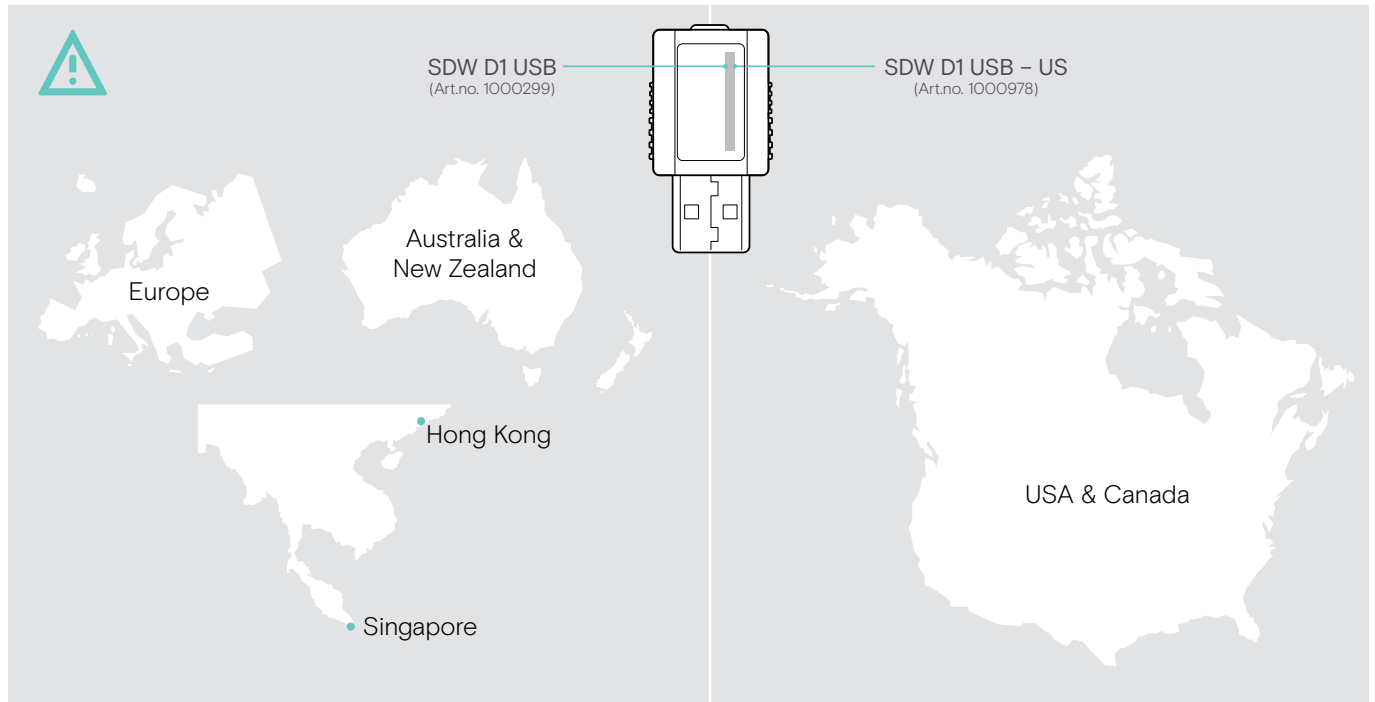

For safety instructions, consult the Safety Guide.



A list of accessories can be found on the product page at www.eposaudio.com.

Package contents

SDW D1 USB dongle

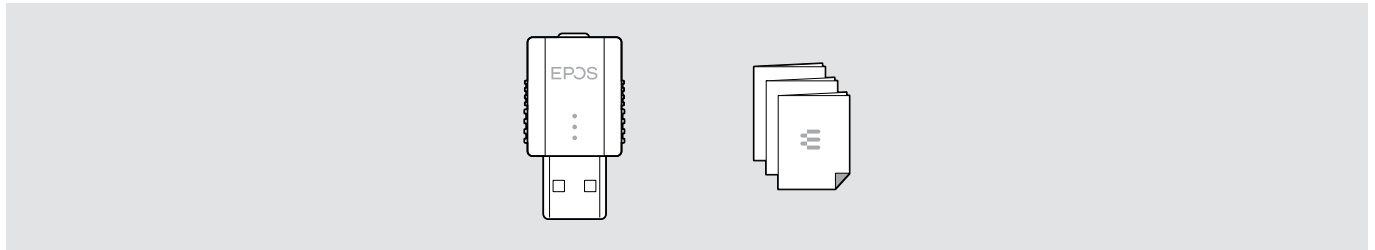

Bundles with headset, carry pouch and charging cable

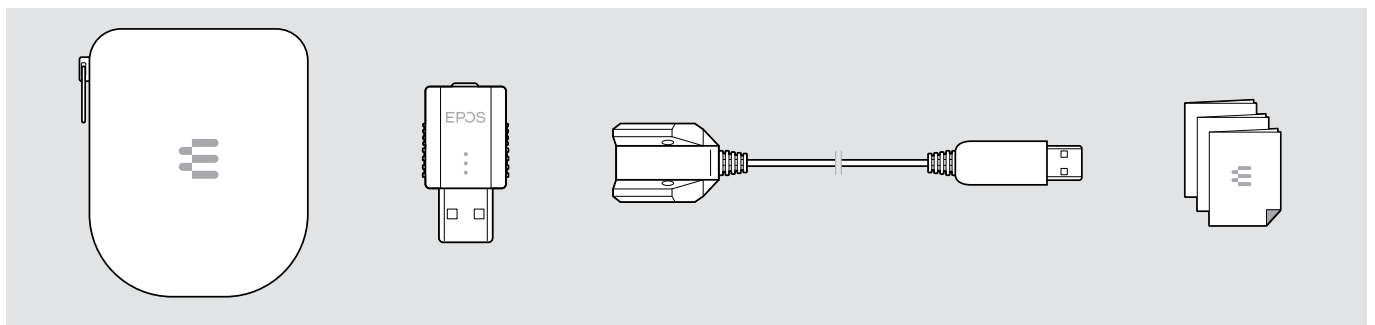
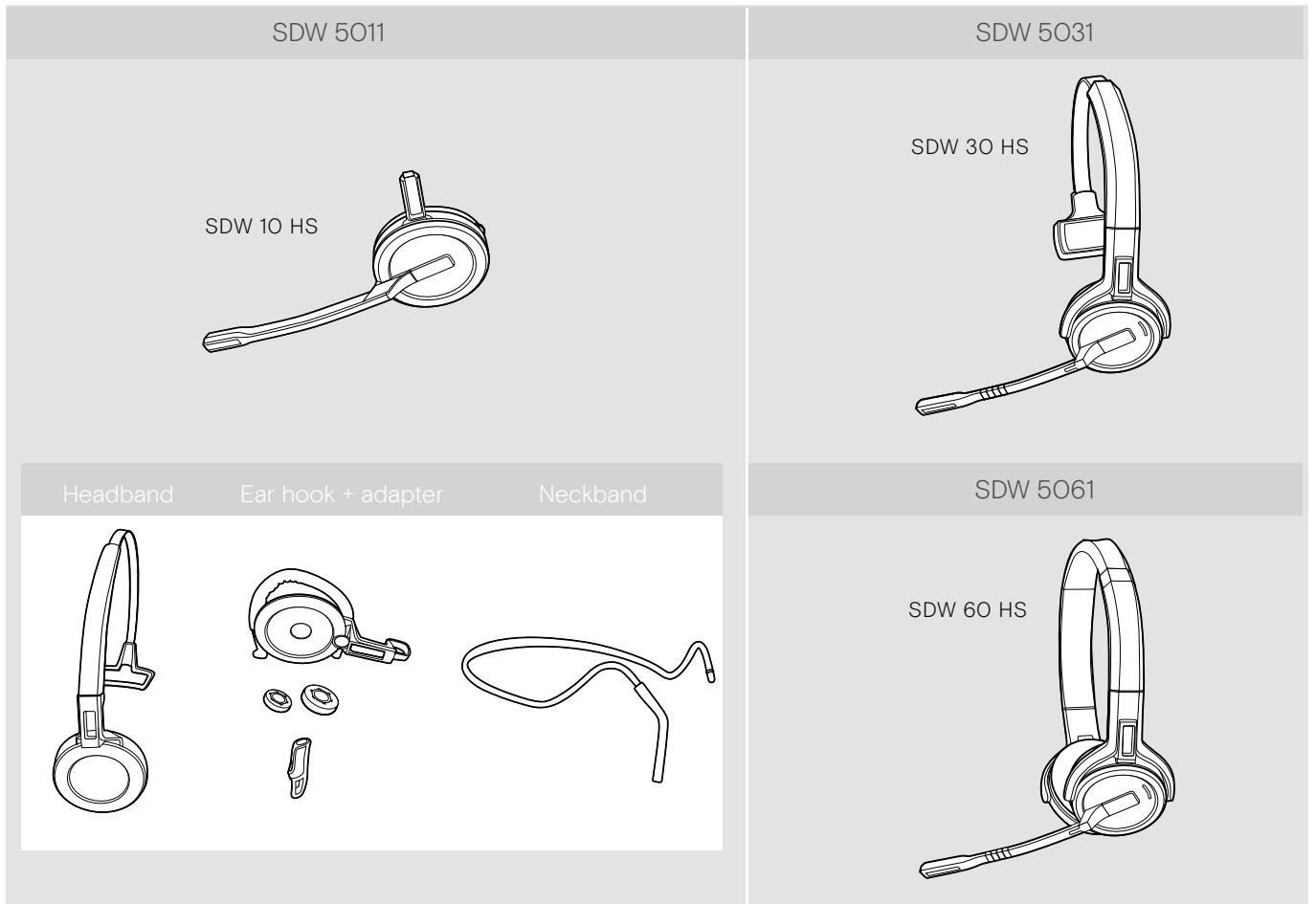

Product overview

Overview of the SDW D1 USB dongle

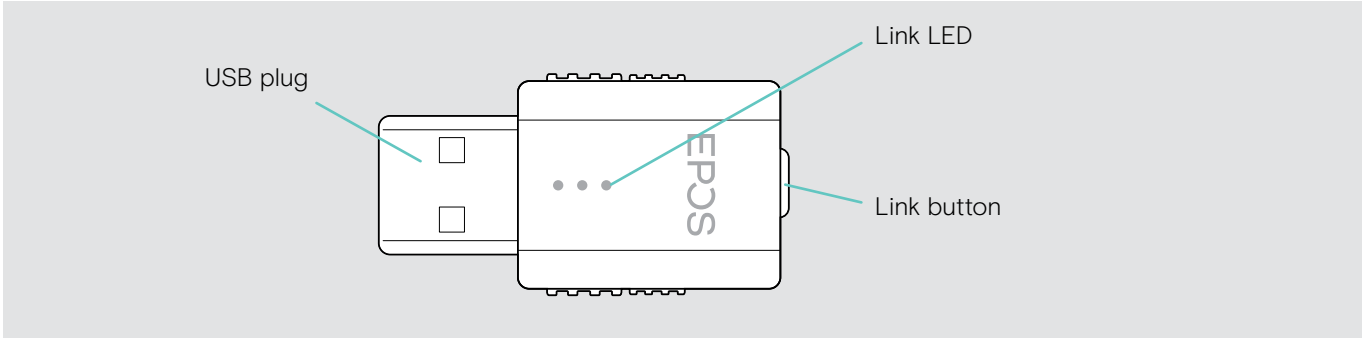

Overview of the headsets

Overview of the headset SDW 10 HS

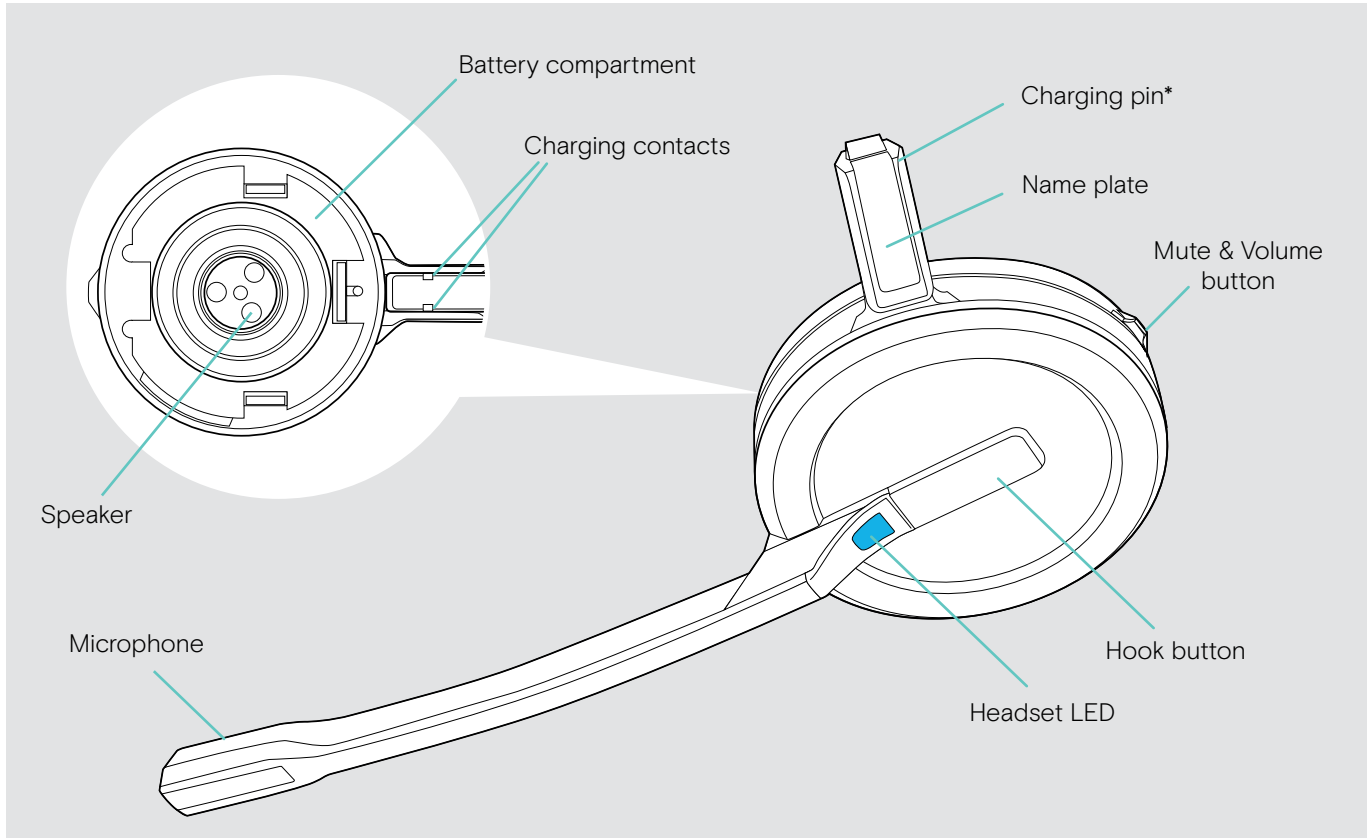

*Inserted into the holder of the headband or wearing style adapter

Overview of the headset SDW 30 HS

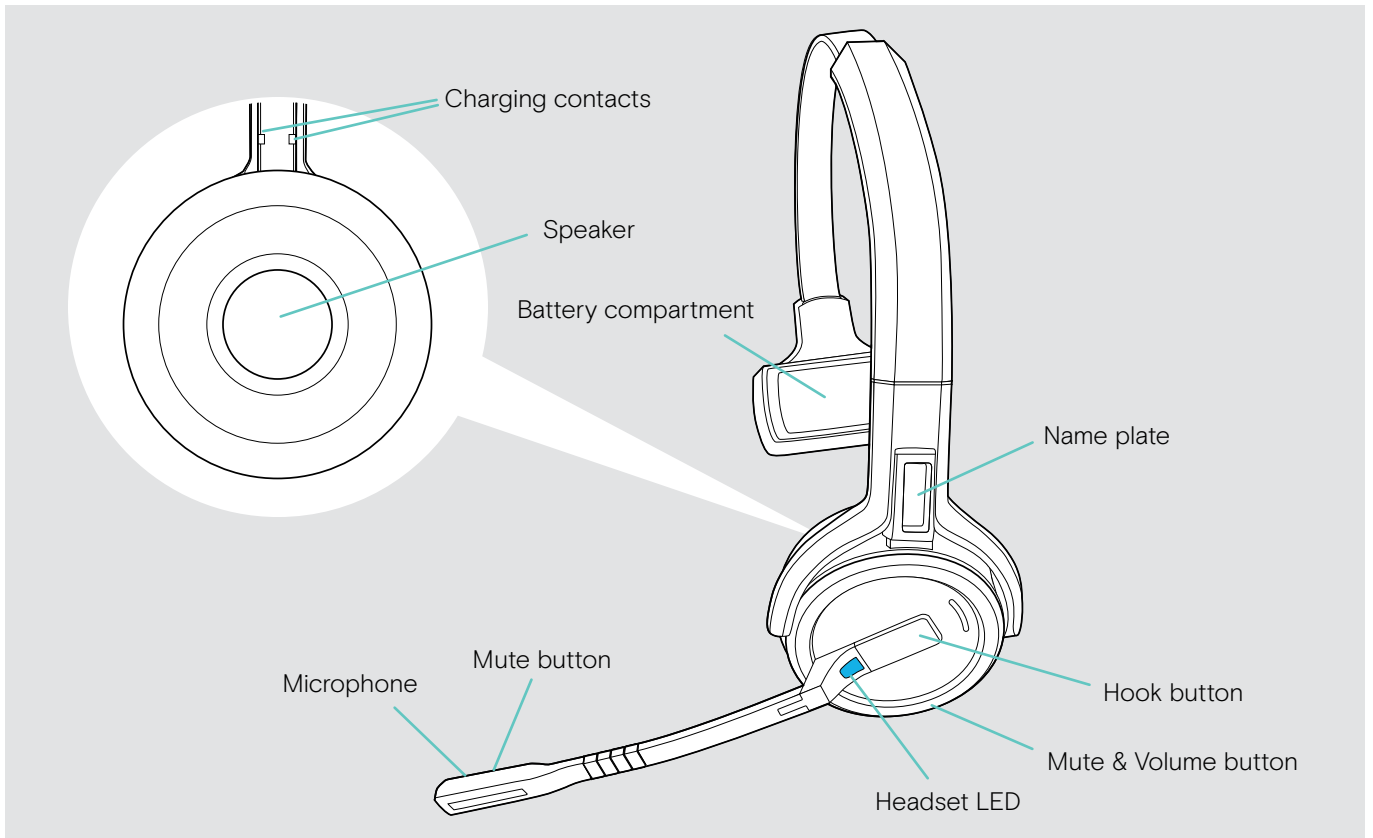



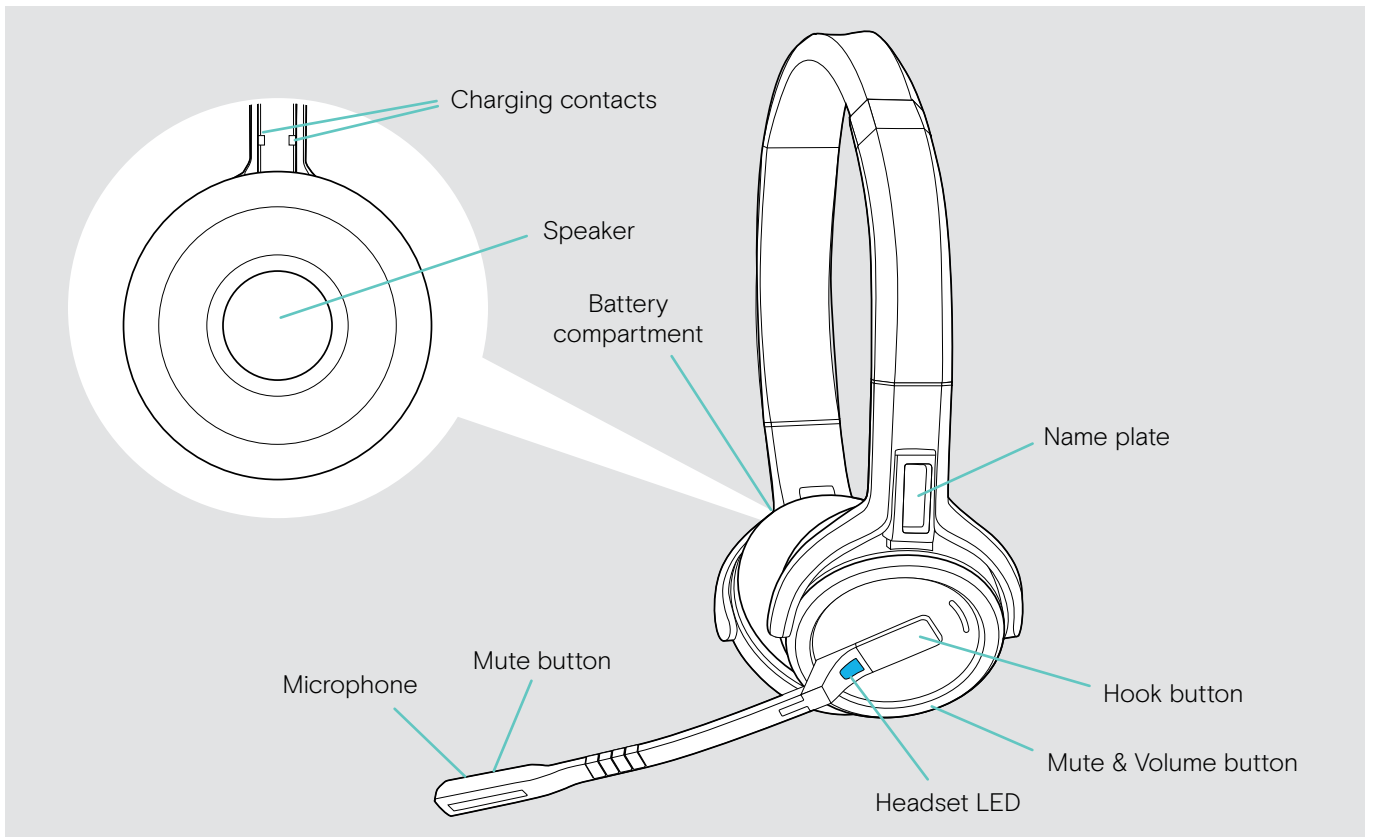





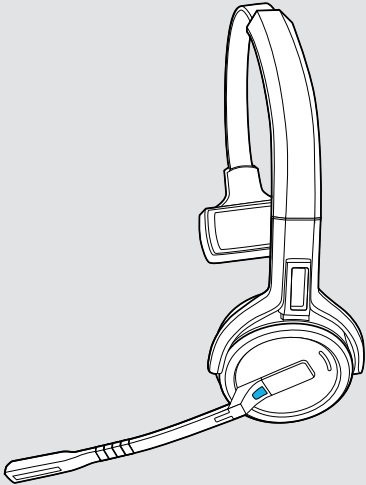







Overview of the headset SDW 60 HS











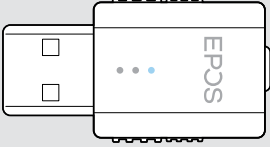





Overview of the LEDs

Overview of the headset LED

Headset	LED	Meaning
	 ...	Headset battery is being charged
	    ...	Headset is being paired to DECT dongle
	3x  ...	<ul style="list-style-type: none"> Headset switches on Headset successfully connected to the dongle
	3x  ...	Headset switches off
	 0.2s  0.2s ...	Incoming call
	 ...	<ul style="list-style-type: none"> Outgoing / active call Softphone status: BUSY
	 ...	Headset in idle mode
	    ...	Firmware upgrade

Overview of the dongle

Dongle	LED	Meaning
	    ...	Dongle in pairing mode: searching for headset to pair and connect
	3x  ...	Pairing successful
	3x  ...	Pairing failed
	 2s  2s ...	Dongle tries to connect to a headset
	 ...	Dongle and headset connected
	 ...	<ul style="list-style-type: none"> Outgoing / active call Media streaming in standard quality
	 0.2s  0.2s ...	Incoming call
	 3s  3s ...	Microphone of the headset is muted

Preparing dongle and headset for use

Charging the headset before first use

- ▶ Charge the rechargeable battery for at least 20 minutes before using it for the first time. A complete charging process takes about 4 hours for SDW 10 HS and 7 hours for SDW 30 HS / SDW 60 HS (see page 22).

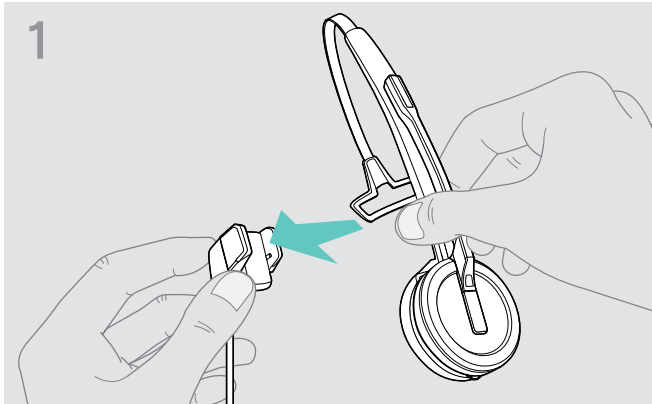

- ▶ Place the headset into the magnetic holder of the charging cable. Alternatively you can use the CH 30 headset charging stand (see page 22).

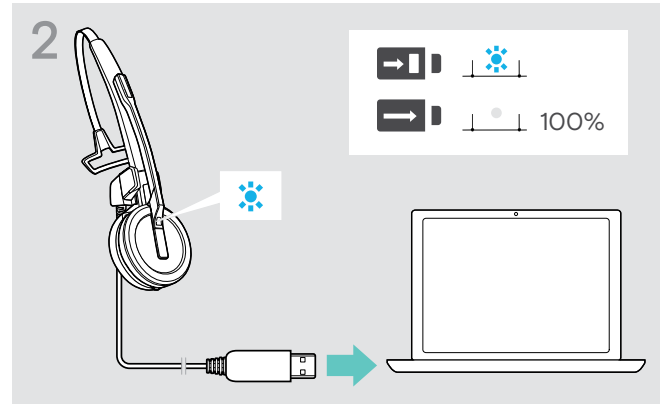

- ▶ Connect the charging cable to a USB socket on your computer. The LED lights up blue until the battery is fully charged.



During the first charging process and after long periods of non-use, it may take up to 5 minutes until the headset LED lights up.

Installing software

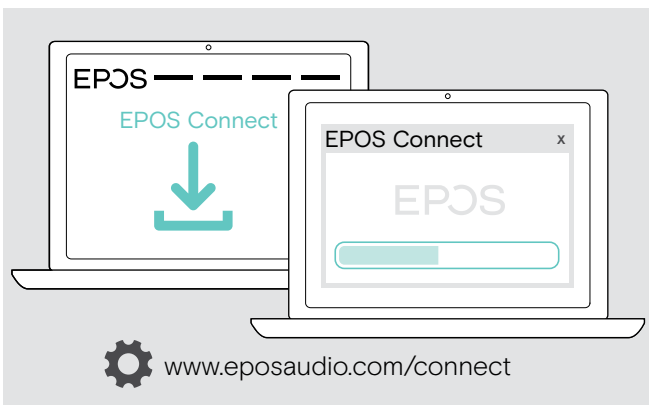

With the free of charge **EPOS Connect** software, you can change the settings for audio quality (narrowband/wideband), range, Audio limiter and USB auto audio.

- ▶ Download the software from www.eposaudio.com/connect.
- ▶ Install the software. You need administrator rights on your computer – if necessary, contact your IT department.

To make calls:

- ▶ Install a **softphone** (VoIP Software) or ask your admin for support.

Connecting the dongle to a computer

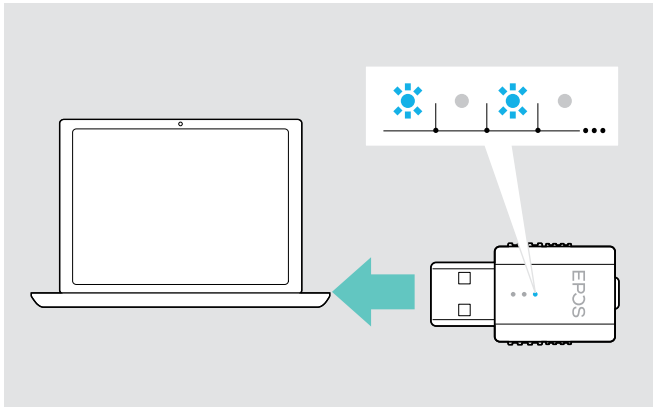

The dongle controls the wireless communication between computer and headset.

- ▶ Connect the dongle to a USB socket on your computer. The dongle flashes blue or goes directly into pairing mode when used for the first time (see next chapter). The operating system detects the USB audio device “EPOS IMPACT D1” and installs the necessary drivers.

Pairing the headset and the dongle

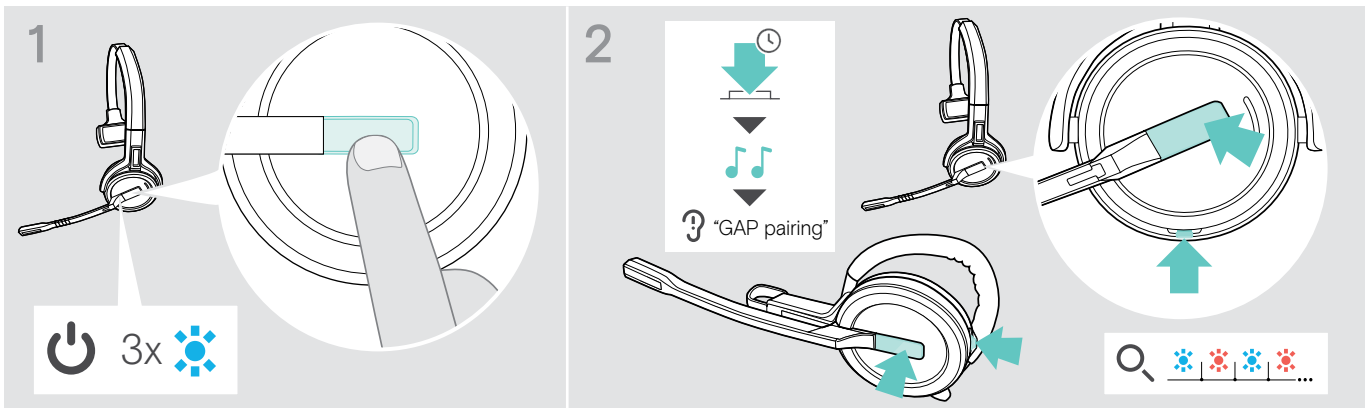

- ▶ Press the hook button to switch the headset on. The LED flashes 3 times blue.
- ▶ Press and hold the hook and mute button simultaneously until you hear 2 beeps and the voice prompt “GAP pairing”. Release the buttons. The LED flashes blue / red alternately.

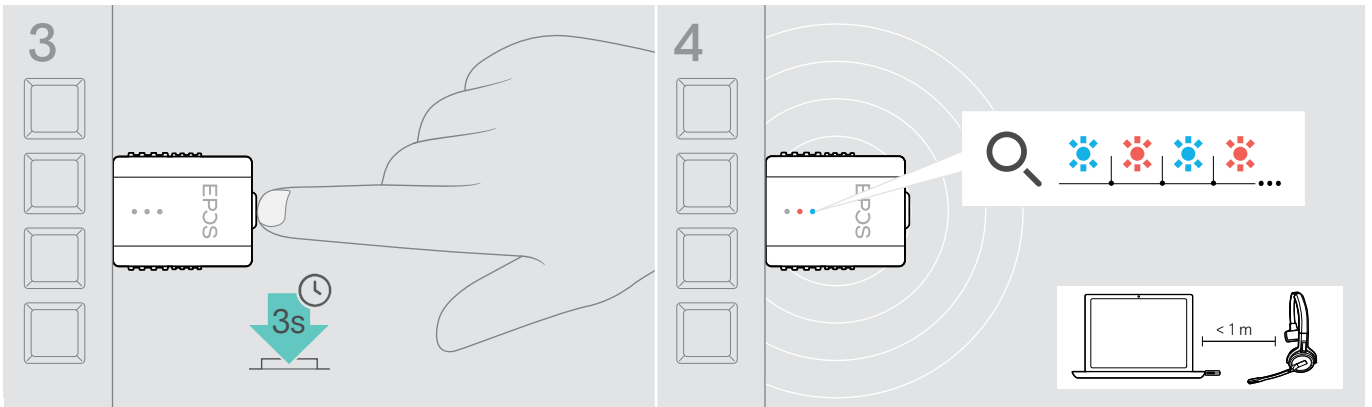

- ▶ Press and hold the dongle’s button for 3 seconds to enter pairing mode. The LED alternately flashes blue and red.

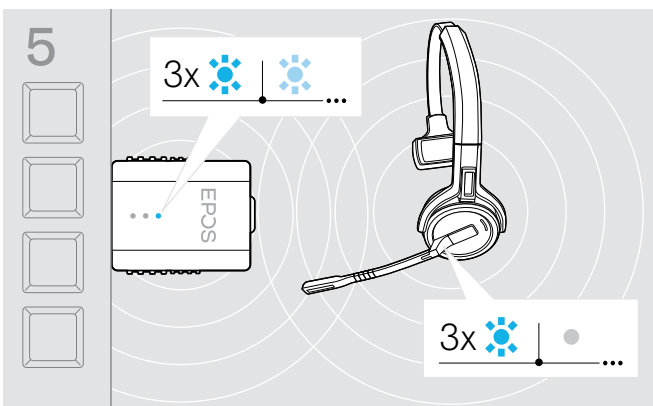

If pairing is successful, the dongle LED lights up dimmed blue and the headset LED switches off.

If pairing is not successful within 2 minutes, headset and dongle switch back to standby mode.

Assembling and wearing the headset SDW 10 HS

You can wear the headset either with the headband, the ear hook or the neckband.

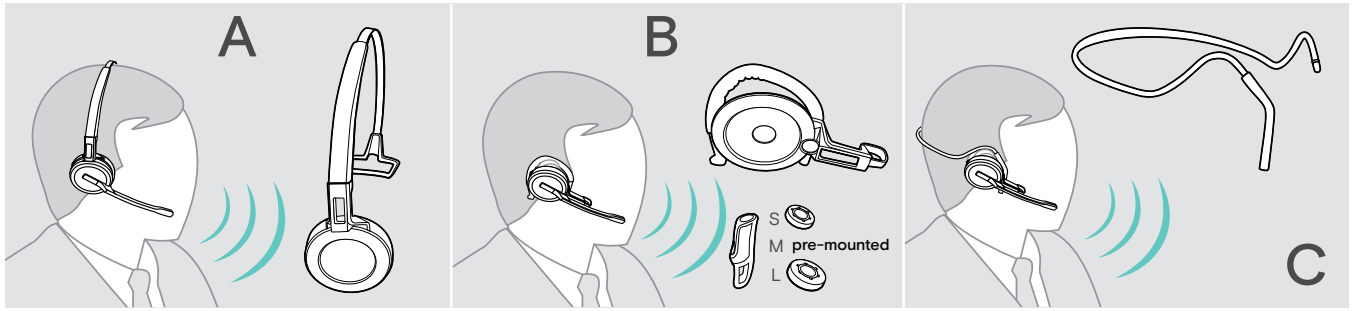

▷ Before assembly, remove the stickers showing where the charging pin should be inserted.

Using the headset with the headband

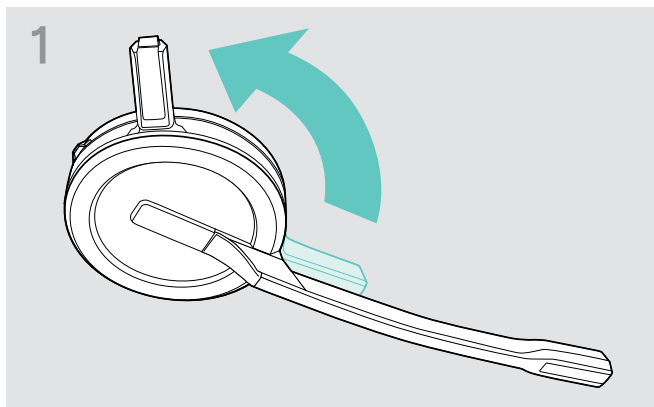

▷ Rotate the headset's charging pin away from the microphone boom.

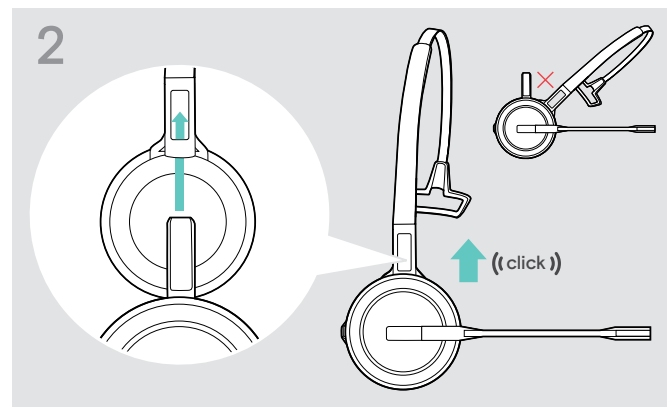

▷ Slide the charging pin into the holder of the headband.

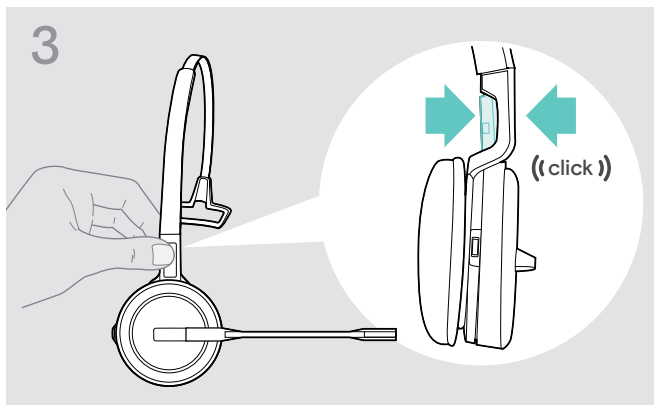

▷ Snap the charging pin into the headband.

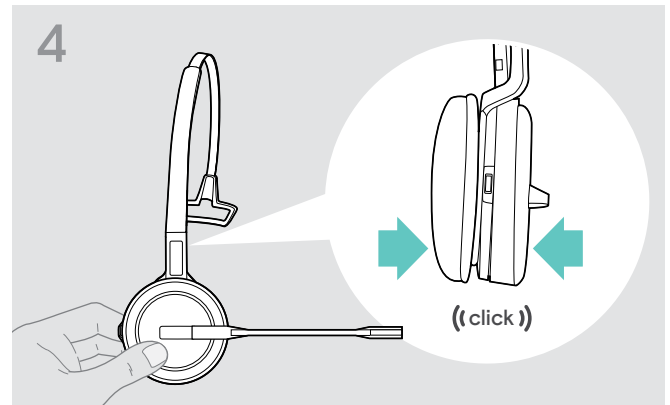

▷ Snap the headset into the circular part of the headband.

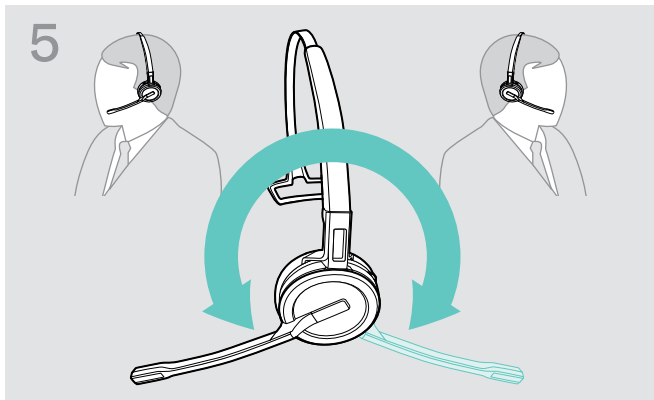

▷ Rotate the microphone boom to change wearing side.

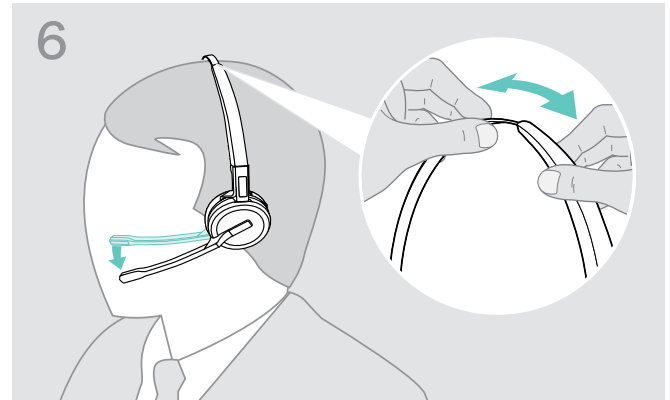

▷ Adjust the headset so that the ear pad rests comfortably on your right or left ear.

Using the headset with the ear hook

Assembling the ear hook and the headset

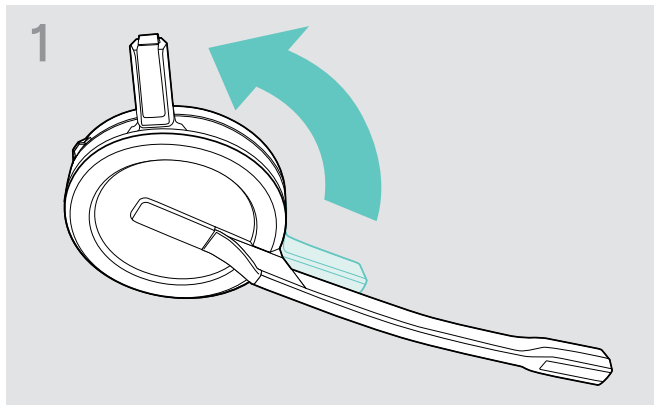

- ▶ Rotate the headset's charging pin away from the microphone boom.

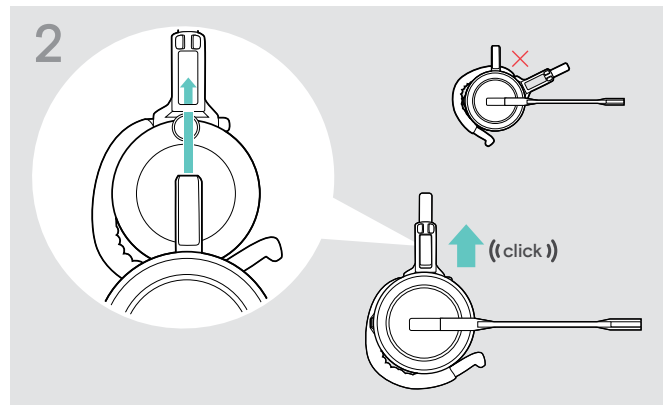

- ▶ Insert the charging pin into the holder of the wearing style adapter.

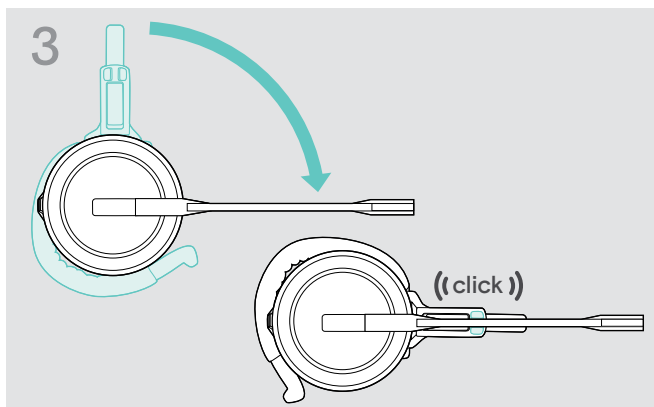

- ▶ Rotate the boomarm to snap it in the wearing style adapter.

Adjusting the ear hook for perfect wearing comfort

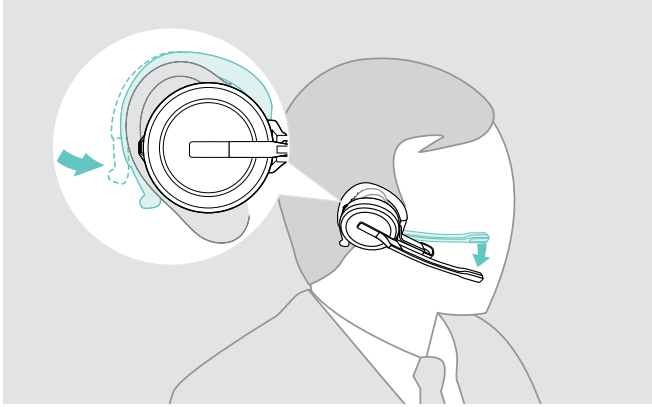

- ▷ Fit the ear hook around your ear with the ear bud placed in your ear.
- ▷ Bend the flexible ear hook so that the headset sits comfortably and securely on your ear.

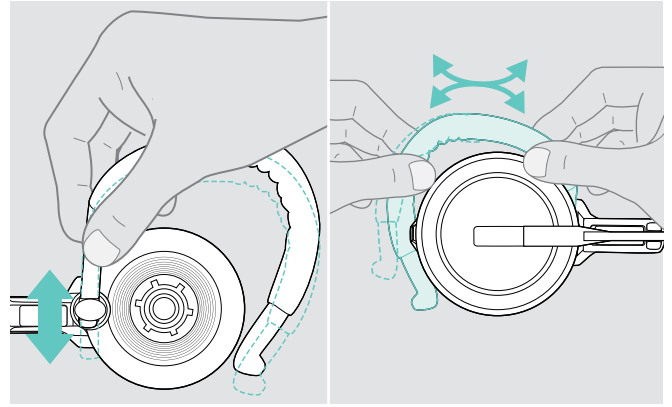

- ▷ Adjust the ear hook's height and shape.

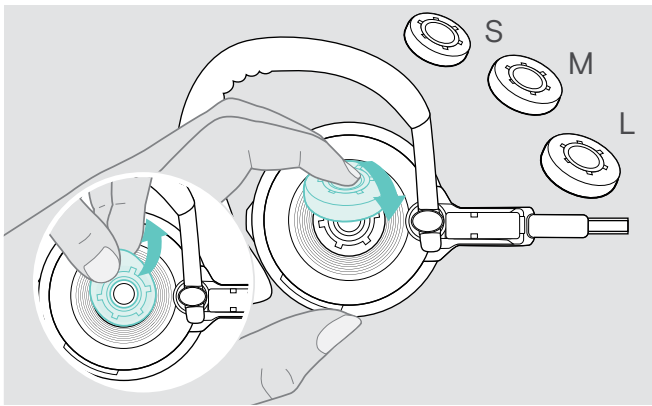

- ▷ Change ear bud size for optimal fit – if required.

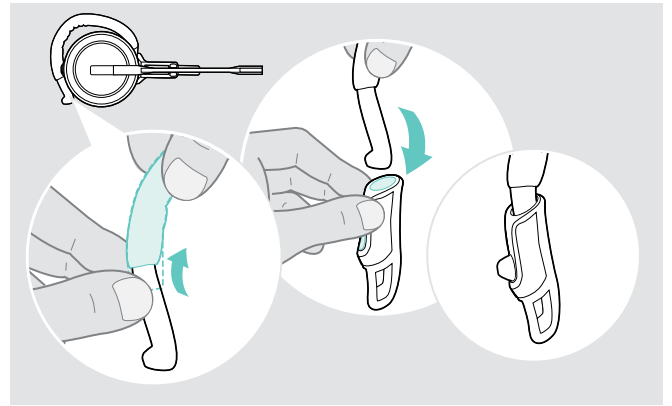

- ▷ Mount the ear hook stabilizer for an improved fit – if required.

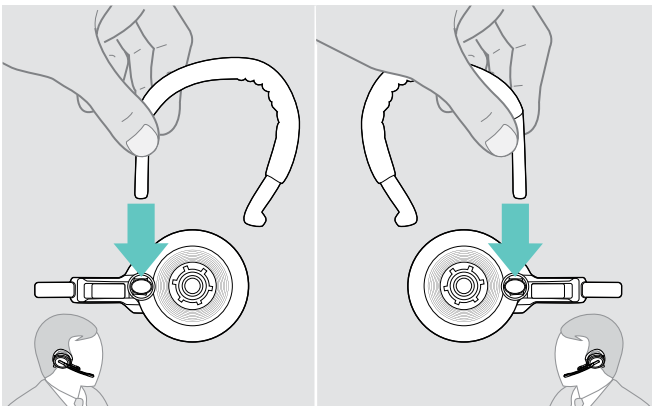

- ▷ Change wearing side – if required.

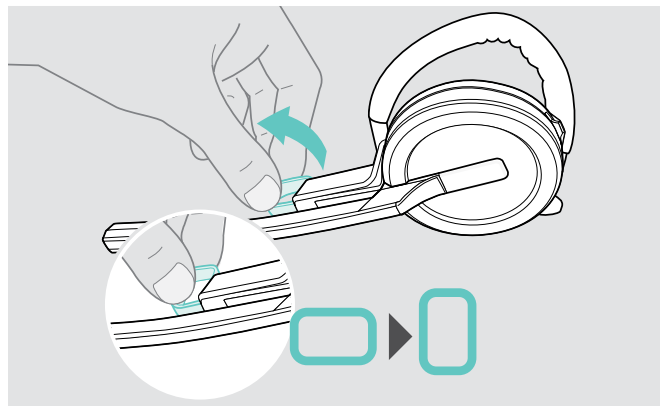

- ▷ Rotate the cheek spacer to increase or decrease the distance between the microphone and your mouth – if required.

Using the headset with the neckband

Assembling the neckband and the headset

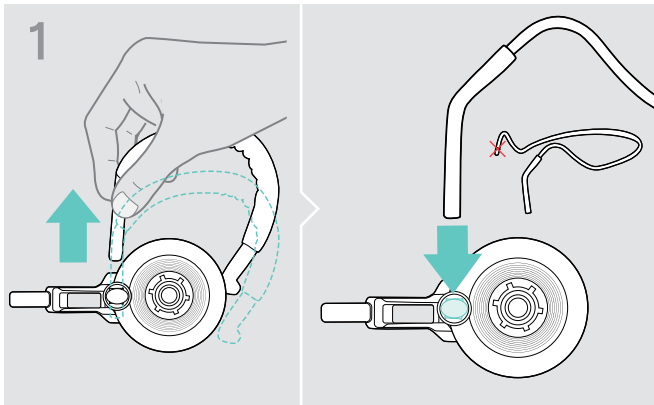

- ▷ Remove the ear hook from the wearing style adapter and insert the neckband instead. Make sure the inserted side has the holder mounted on the neckband.

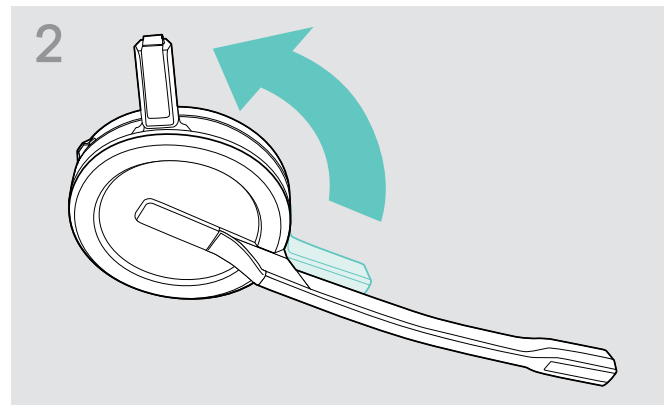

- ▷ Rotate the headset's charging pin away from the microphone boom.

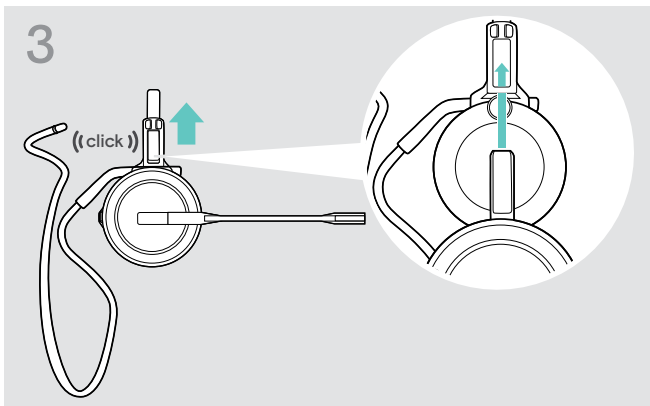

- ▷ Insert the charging pin into the holder of the wearing style adapter.

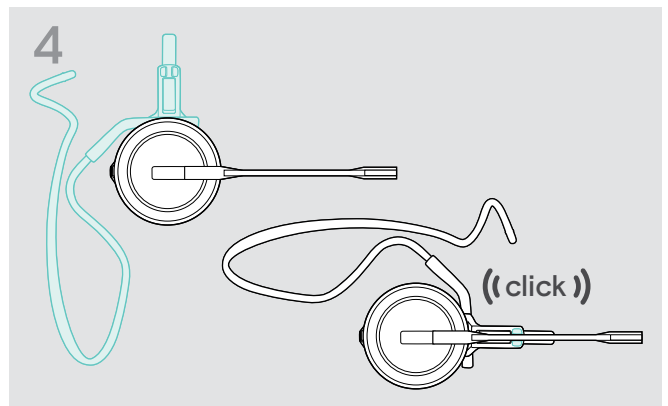

- ▷ Rotate the boomarm to snap it on the wearing style adapter like shown.

Adjusting the neckband for perfect wearing comfort

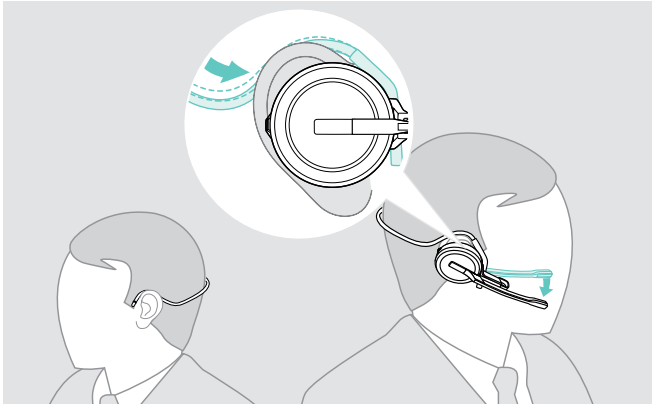

▷ Fit the neckband around your neck and both ears. Ensure that the ear bud is placed in your ear.

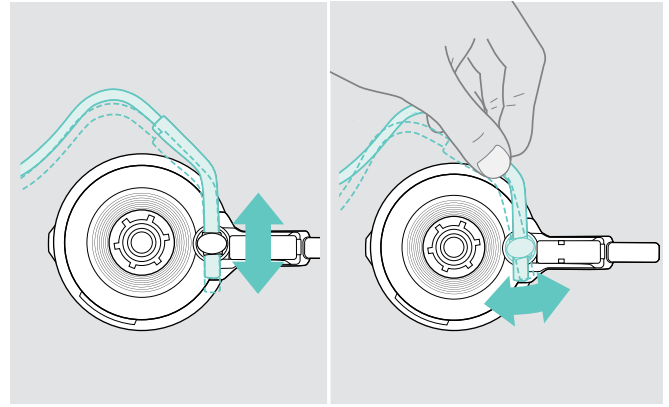

▷ Adjust the neckband's height and angle.

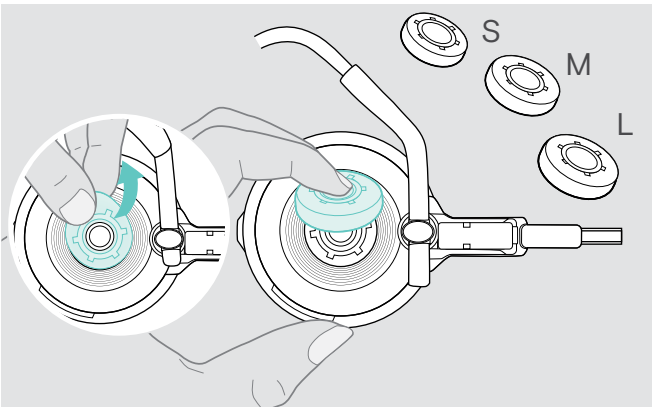

▷ Change ear bud size for optimal fit – if required.

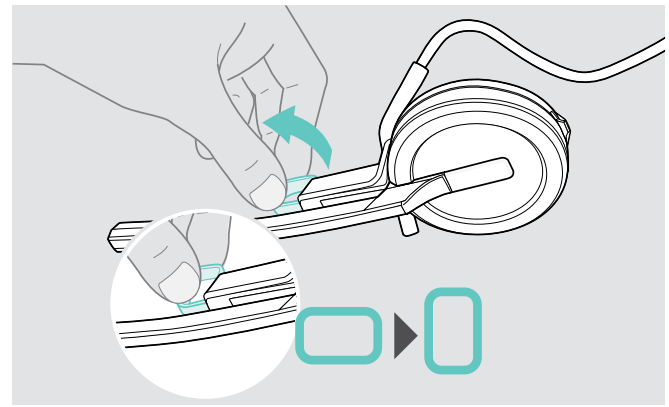

▷ Rotate the cheek spacer to increase or decrease the distance between the microphone and your mouth – if required.

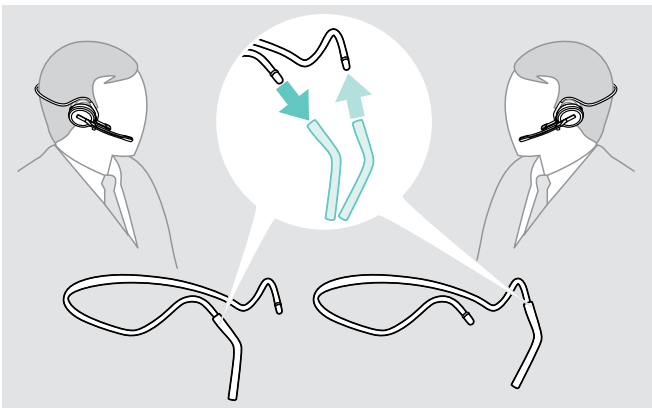

▷ Change wearing side – if required.

Detaching headband, ear hook or neckband

CAUTION

Improper handling can damage the product!

If the charging pin and microphone boom overlap while detaching, they can break.

- ▷ Rotate the charging pin as shown.

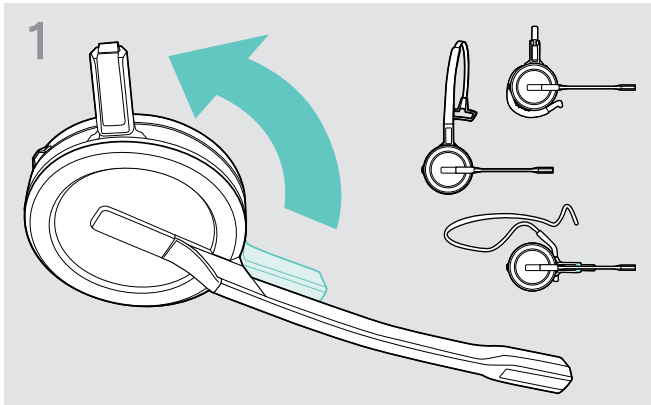

- ▷ Rotate the holder with the charging pin away from the microphone boom.

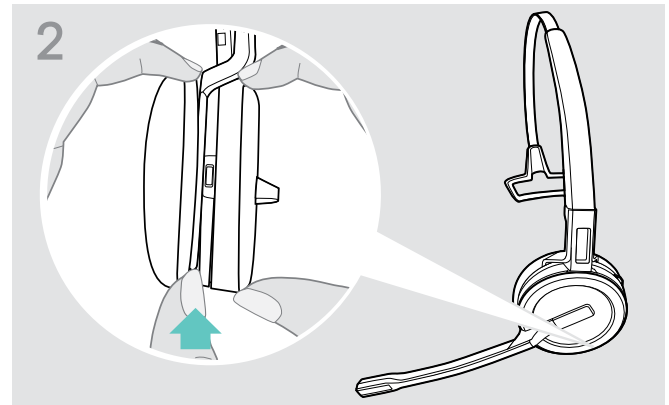

- ▷ Hold the headset with the one hand.
- ▷ Slide one finger of the other hand into the small recess on the headband or wearing style adapter.

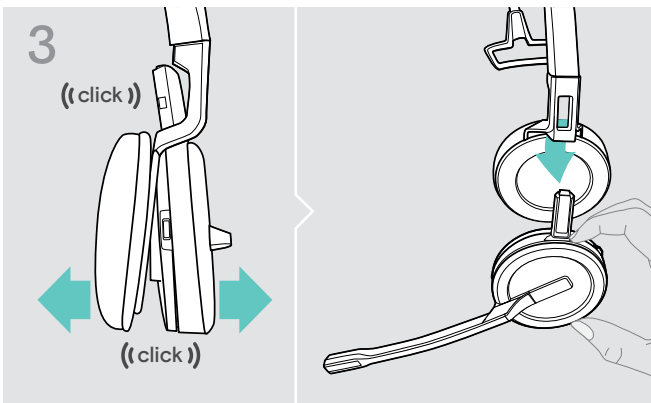

- ▷ Pull the two units apart from each other. The headset loosens and you hear a click.
- ▷ Remove the headset from the holder.

Adjusting and wearing the headset SDW 30 HS | SDW 60 HS

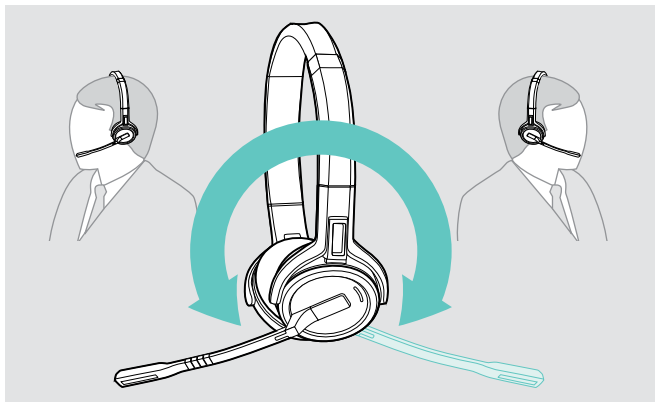

▷ Rotate the microphone boom to change wearing side.

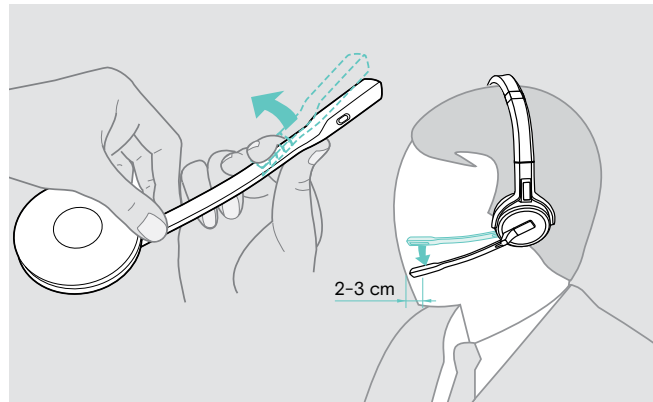

▷ Bend and rotate the microphone boom so that the microphone is about 0.8" (2 cm) from the corner of your mouth.

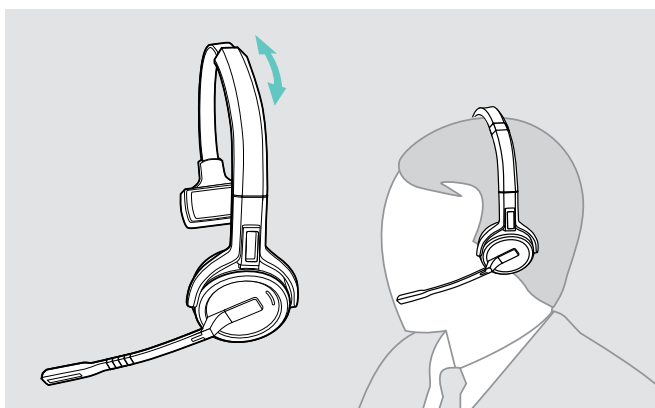

▷ Adjust the headset so that the ear pad rests comfortably on your right or left ear.

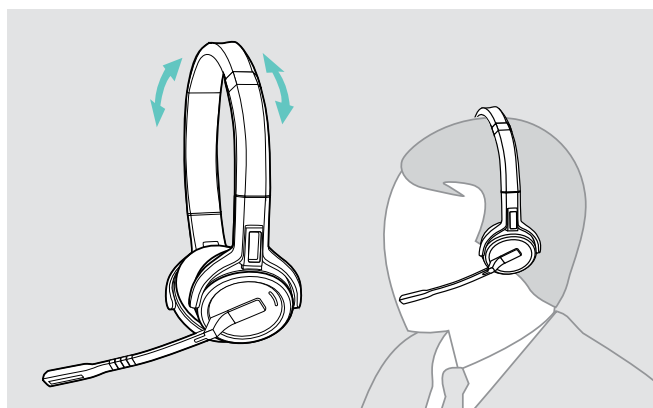

▷ Adjust the headset so that the ear pads rest comfortably on your ears.

Labeling the headset

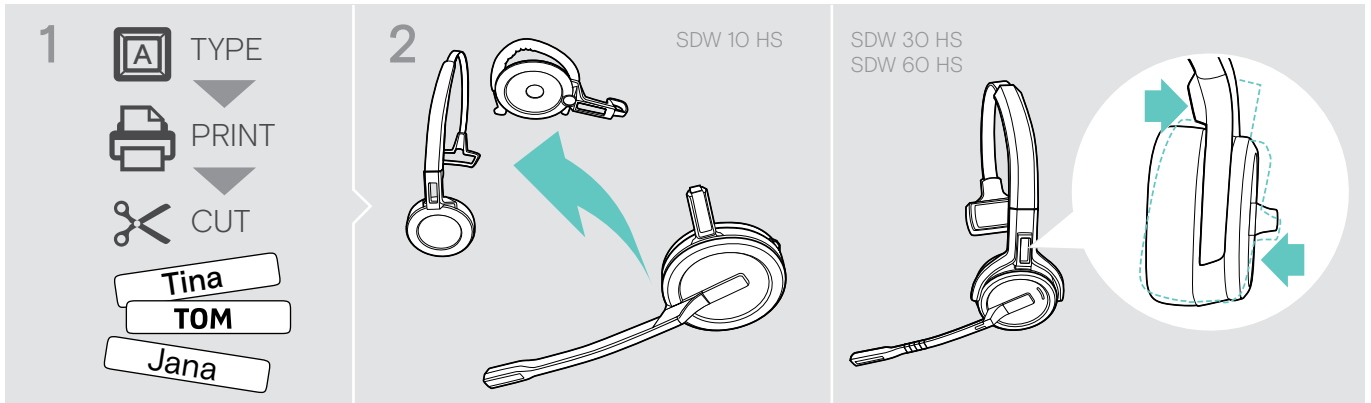

SDW 10 HS:

- ▷ Detach the headband or wearing style adapter from the headset (see page 14).

SDW 30 HS | SDW 60 HS:

- ▷ Tilt the earcup with the boom arm as shown.

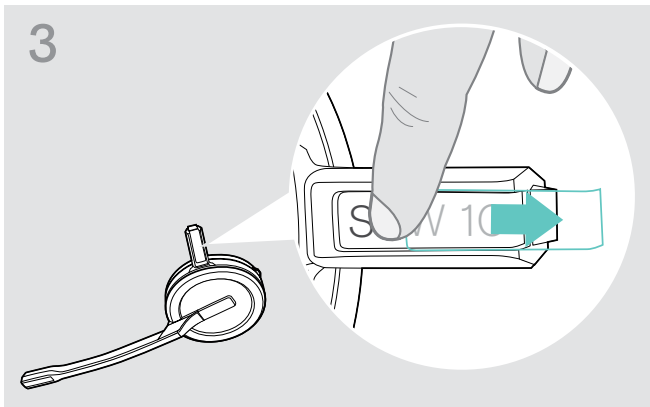

- ▷ Remove the cover.

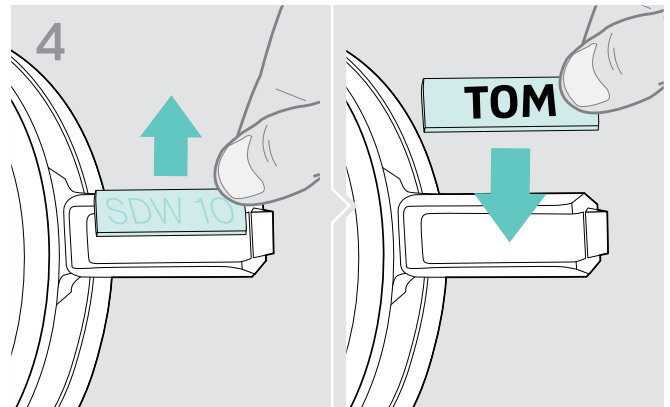

- ▷ Replace the name plate.

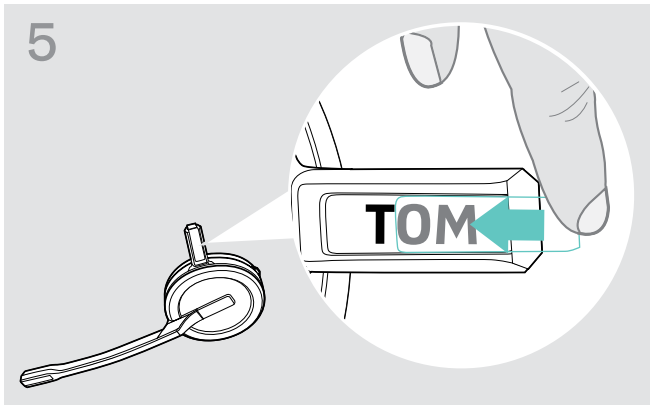

- ▷ Slide the cover in the holder.

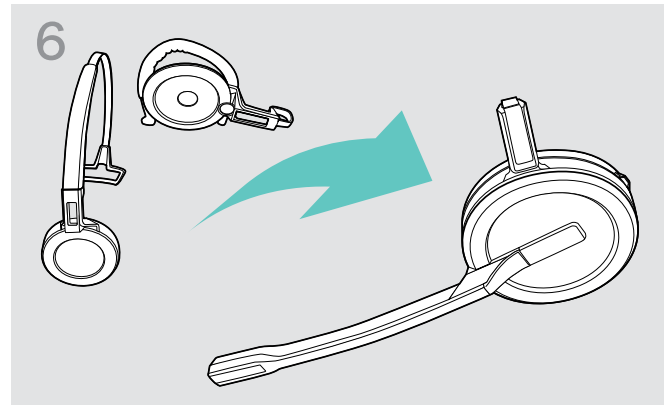

SDW 10 HS:

- ▷ Reassemble the headset with the headband or wearing style adapter (see page 9).

Setting up and using the headset

Switching the headset on

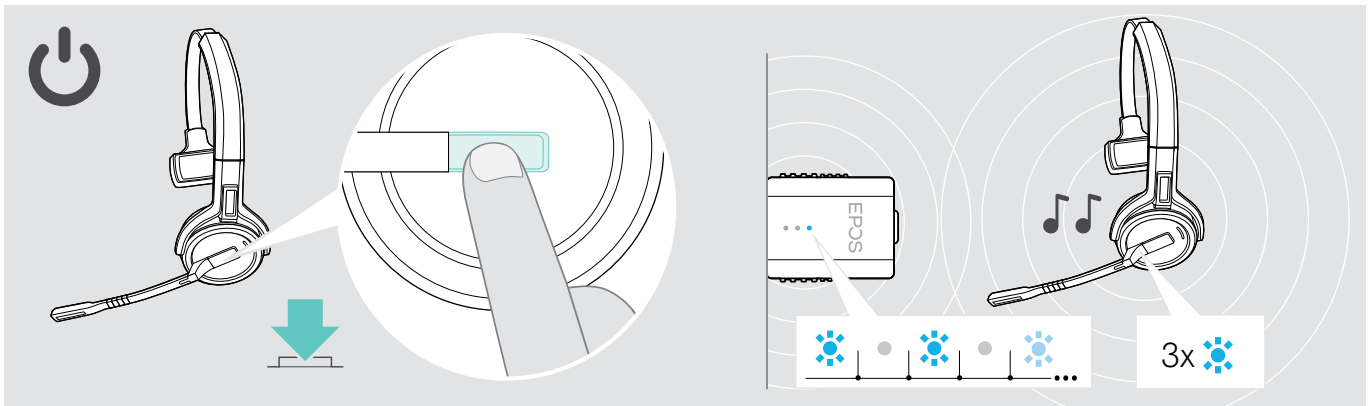

- ▶ Press the hook button.

The headset switches on and searches for the dongle*. If the connection is successful, you hear 2 beeps. The headset LED flashes blue 3 times and the dongle LED lights up dimmed blue.



*If the headset was last used with a base station, it searches for the base station instead of the dongle. For how to switch the search to the dongle, see page 24.

Switching the headset off

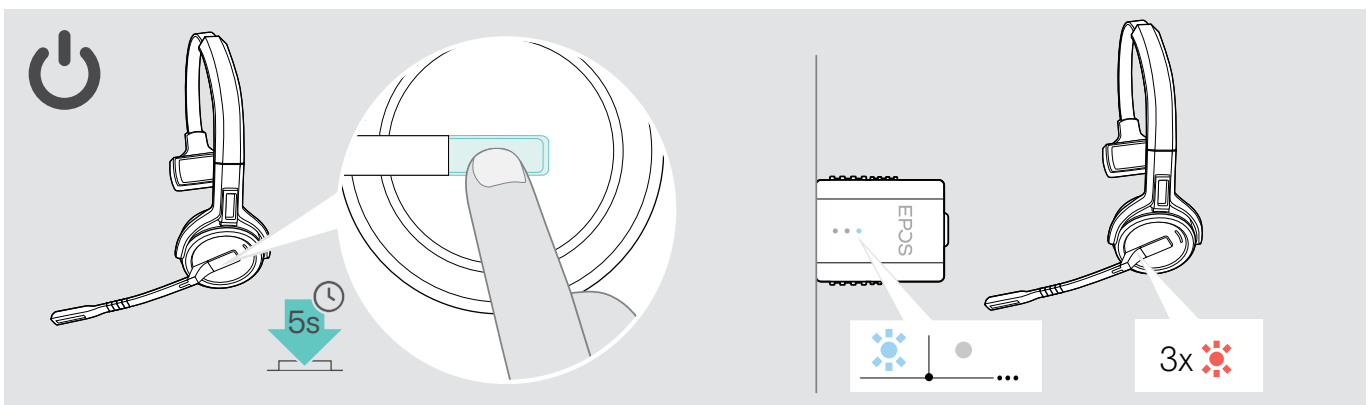

- ▶ Press the hook button for 5 seconds.

The headset switches off. The LED on the headset flashes red 3 times and the dongle LED lights turns off.



To ensure that the headset is fully charged when needed:

- ▶ Dock it to the charging cable or the optional charging stand CH 30 (see page 22).

Adjusting the volume



CAUTION

Hearing damage due to high volumes!

Listening at high volume levels for long periods can lead to permanent hearing defects.

- ▷ Set the volume to a low level before putting on the headset.
- ▷ Do not continuously expose yourself to high volumes.

Adjusting the speaker volume

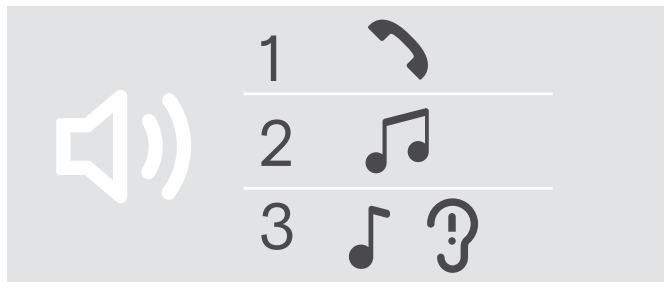

You can adjust three independent volume settings for the headset:

1. Call volume: during an active call
2. Media volume: during media streaming
3. Volume for ring tone, tones and voice prompts: in idle mode – no active call or media streaming

The direction of the volume buttons can be swapped.

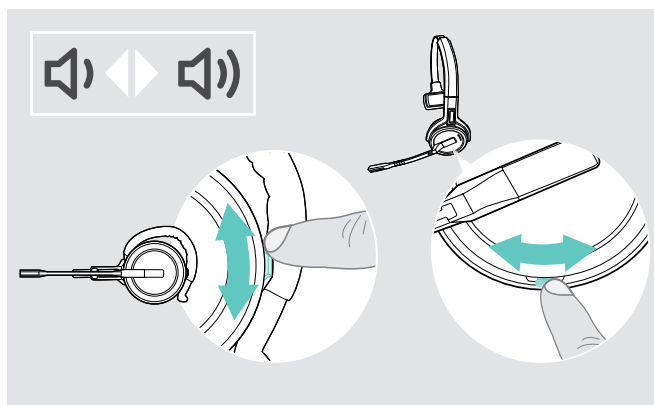

To adjust **volume for calls and the audio signal**:

- ▷ Make a call (see page 20).
- ▷ Move the Volume button to adjust the volume.

To adjust volume for **ring tone, beeps and voice prompts**:

- ▷ Make sure that the headset is in idle mode – no active call or media reproduction.
- ▷ Move the Volume button to adjust the volume.

When the minimum or maximum volume is reached, the voice prompt “Volume min” or “Volume max” is announced in the headset. When the voice prompts are disabled, you hear a beep in the headset instead.

Adjusting the headset’s microphone volume for softphones

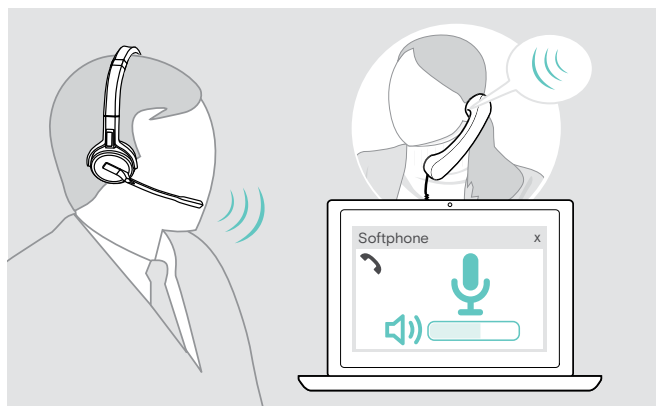

- ▷ Make a call to someone who will help you find the correct volume setting for your microphone.
- ▷ Change the microphone volume in your softphone application* and / or in your computer’s audio application.

*Activate the option “Automatically adjust microphone sensitivity” – if available.

Swapping the direction of the volume buttons

You can change the direction of the Volume button if, for example, you want to wear the headset on the other ear.

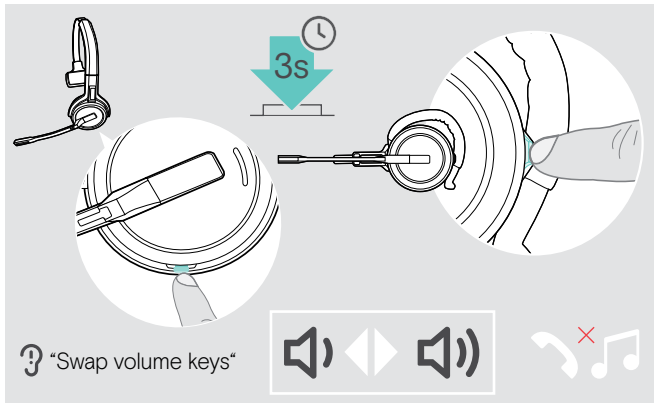

- ▶ Press and hold the Mute & Volume button while headset is in idle mode – no active call or media reproduction. The direction of the button is changed. The voice prompt “Swap volume keys” is announced.

SDW 60 HS:

Stereo channels left / right will be changed too.

Muting the headset’s microphone

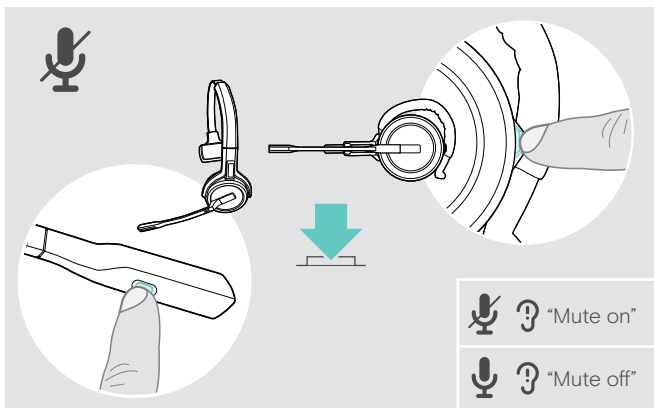

- ▶ Press the Mute & Volume button on the headset **OR** Mute button on the boom arm for SDW 30 HS | SDW 60 HS.

The microphone is:

- muted:
 - The voice prompt “Mute on” is announced.
 - The dongle LED flashes red.
- unmuted:
 - The voice prompt “Mute off” is announced.
 - The dongle LED lights up dimmed blue.

Making calls

During a call the dongle LED lights up blue and the headset LED lights up red.

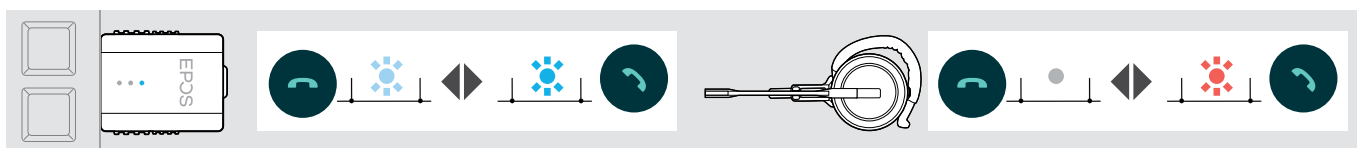

Making / ending a call

Start or end the call via your softphone OR Press the hook button on the headset.

		Initiates a call: dongle LED lights up blue
		Ends a call*



*To ensure that the headset is fully charged when needed:

▷ Dock it to the charging cable or the optional charging stand CH 30 (see page 22).





Handling a call

When you receive a call, you hear a ring tone in the headset and the LED flashes blue.

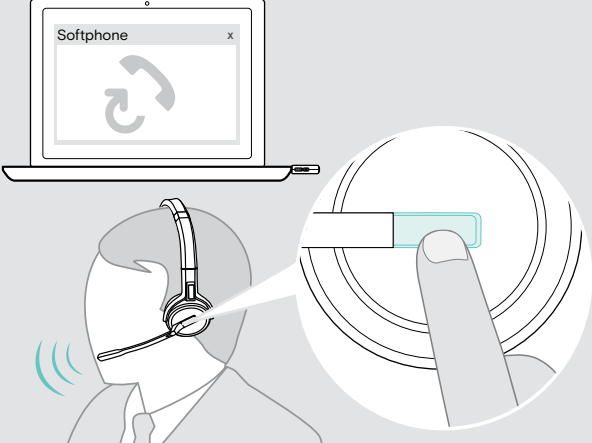
		Accepts a call
		<ul style="list-style-type: none"> • Puts the call on hold (pause) "Call held" • Resumes the call "Call unheld"
		Rejects a call "Call rejected"

Redialing*











		Redials the last number "Redialing"
		Cancels redialing

* This feature is softphone dependent

Managing a second call – second softphone



Active call	2nd incoming call	
		 Accepts the incoming call and puts the active call on hold
		 Rejects the incoming call and continues the active call
		 Toggles between the active and held call

Additional functions

Verifying battery life

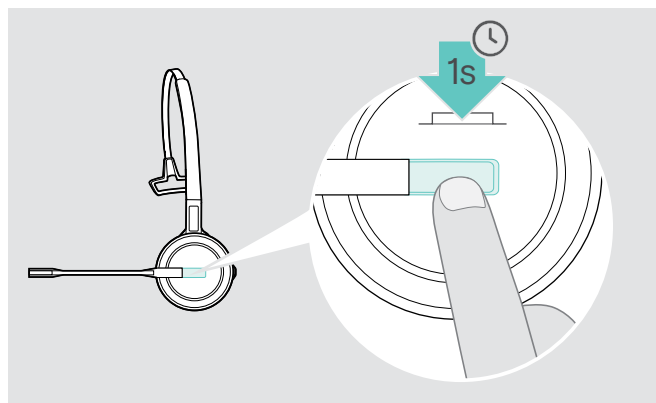

You can retrieve information on the remaining battery life at any time except when you are on a call or listening to media playback:

- ▶ Press the hook button for 1 second. The remaining battery life is announced.



Shortly before the rechargeable battery is about to run flat (15 minutes remaining) the voice prompt "recharge headset" is announced.

Information announced	Remaining battery life
"More than eighty percent battery left"	> 80%
"More than sixty percent battery left"	> 60%
"More than forty percent battery left"	> 40%
"More than twenty percent battery left"	> 20%
"Less than twenty percent battery left"	< 20%

Charging the headset

To ensure that the headset is fully charged when needed:

- ▶ Dock it to the charging cable A or the optional charging stand CH 30* B.

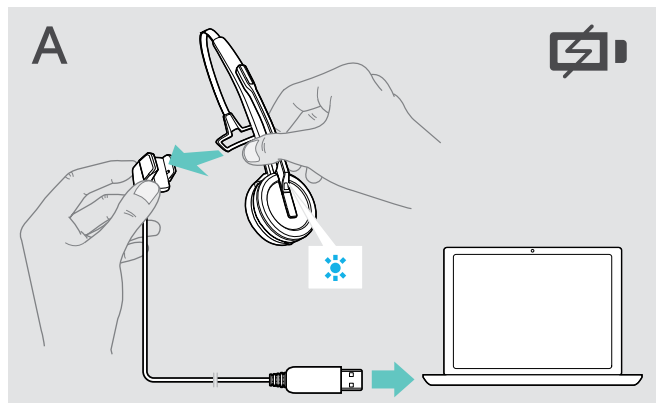

- ▶ Connect the charging cable with your computer.
- ▶ Place the headset into the magnetic holder of the charging cable.

The battery is being charged. The LED lights up blue until the battery is fully charged.

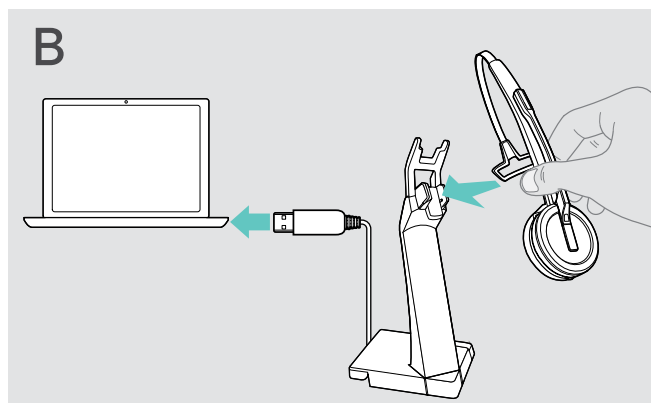

- ▶ Connect the charging stand with your computer.
- ▶ Place the headset into the magnetic holder of the charging stand CH 30.

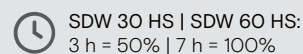
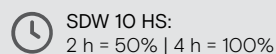

If the headset has not been used for 12 hours, it will switch off in order to conserve battery power. To switch it on again, press the headset's hook button.

*A list of accessories can be found on the product page at www.eposaudio.com.

If you leave the DECT range

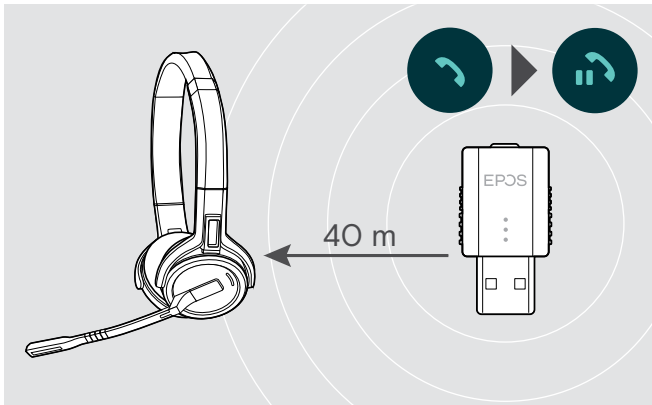

In office buildings, the range between DECT headset and dongle is up to 40 m.

If the audio quality deteriorates during a call or the link breaks down completely, the voice prompt **“device disconnected”** is announced in the headset.

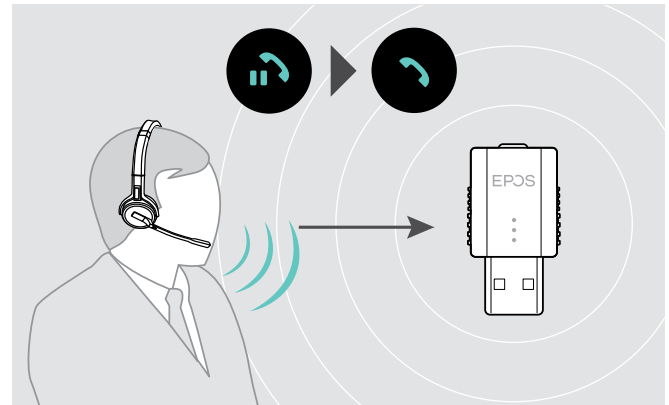

▷ Re-enter the radio range of the dongle to resume the call.

If your softphone supports call control, the call will automatically be ended 60 seconds after leaving the radio range.

Reconnecting the headset

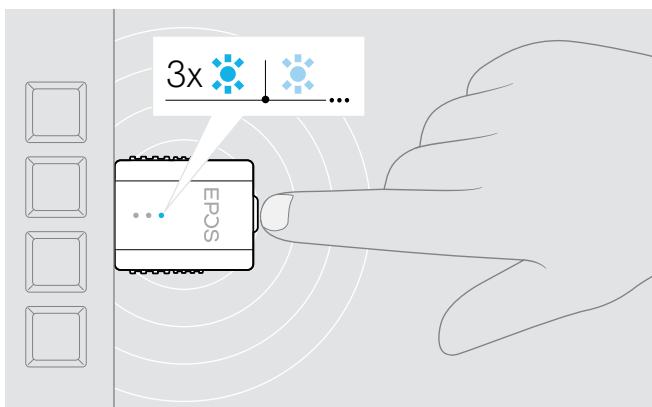

If the headset was out of range and lost connection to the dongle:

▷ Tap the dongle’s button.
The LED flashes 3 times blue and lights to dimmed blue if the connection is established.

Enabling / disabling voice prompts

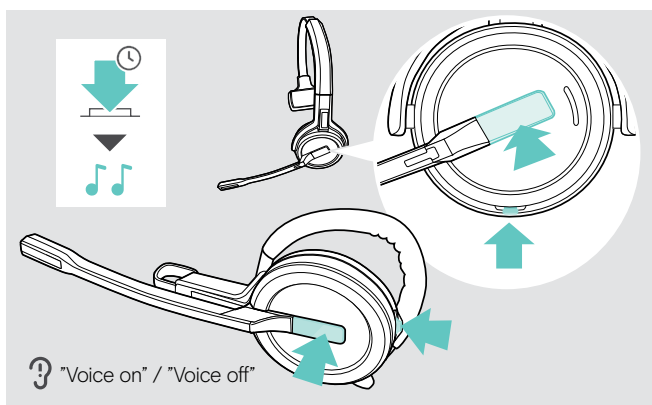

▷ Simultaneously press and hold the hook and mute button until you hear 2 beeps, then release the button. The voice prompts are now activated or deactivated and the voice prompt **“Voice on”** or **“Voice off”** is announced. If the voice prompts are deactivated, the headset emits beeps.

Switching between DECT dongle and base station

Your headset can be connected to either a DECT dongle or an IMPACT SDW 5000 base station.

You can switch between these two devices when your headset is in idle mode – no active call or media reproduction.

Switching from the base station to the dongle

The headset needs to be paired to the dongle (see page 8).

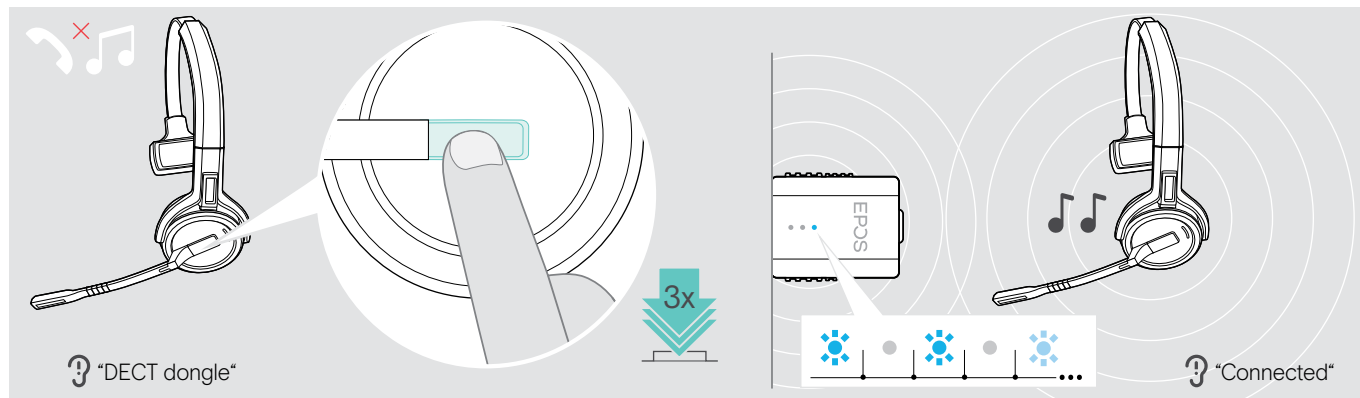

- ▶ Press the hook button 3 times.

The voice prompt “DECT dongle” is announced in the headset. If the voice prompts are disabled, you hear a beep instead.

If the connection is successful, the dongle LED lights up dimmed blue. The voice prompt “Connected” is announced in the headset. If the voice prompts are disabled, you hear 2 beeps instead.

Switching from the dongle to the base station

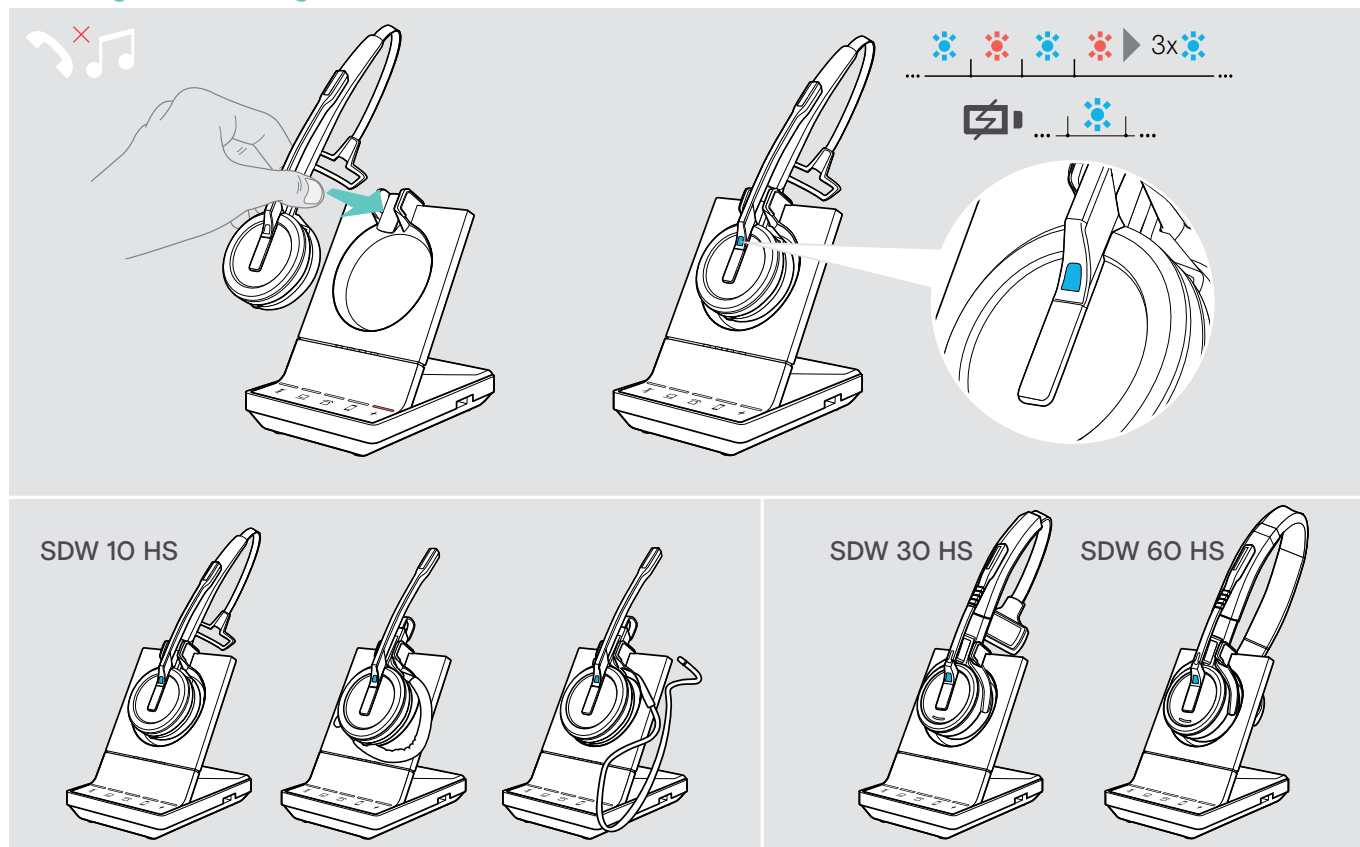

- ▶ Place the headset into the magnetic holder of the base station.

The headset is paired to the base station, the LED flashes blue and red. The LED turns blue when pairing is complete and the headset will start charging.

Cleaning and maintaining the headset system

CAUTION

Liquids can damage the electronics of the product!

Liquids entering the housing of the device can cause a short circuit and damage the electronics.

- ▷ Keep all liquids far away from the product.
- ▷ Do not use any cleansing agents or solvents.

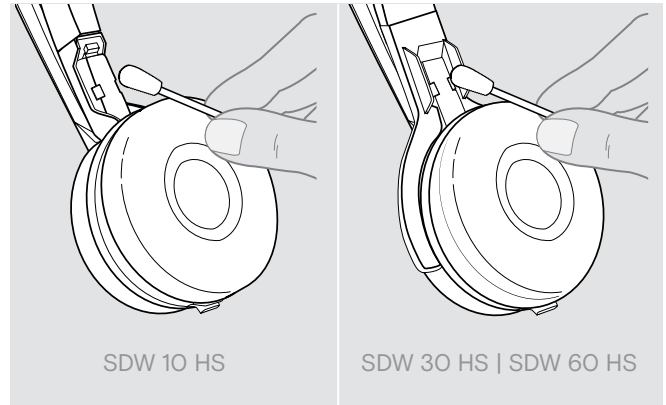
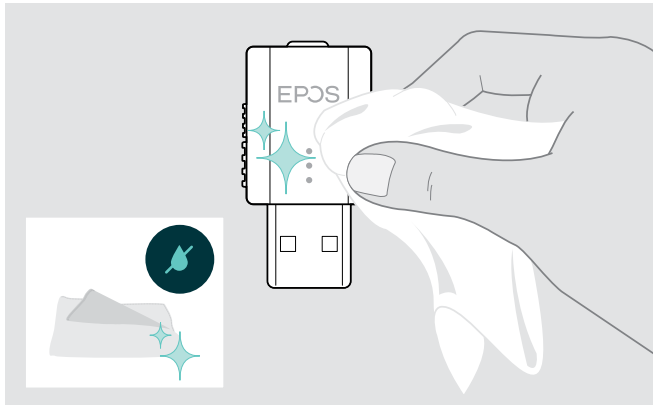

- ▷ Only use a dry and soft cloth to clean the product.
- ▷ Clean the charging contacts of the headset and the charging cable from time to time using e.g. a cotton swab.

Replacing the ear pads

For hygienic reasons, you should replace the ear pads from time to time. Spare ear pads are available from your EPOS partner.

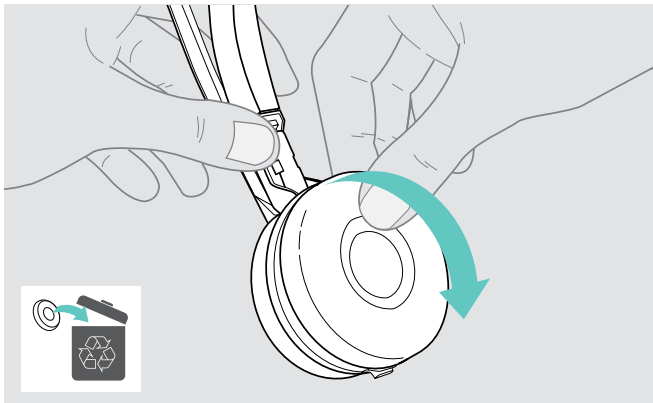

- ▷ Carefully remove the old ear pad from the ear cup.

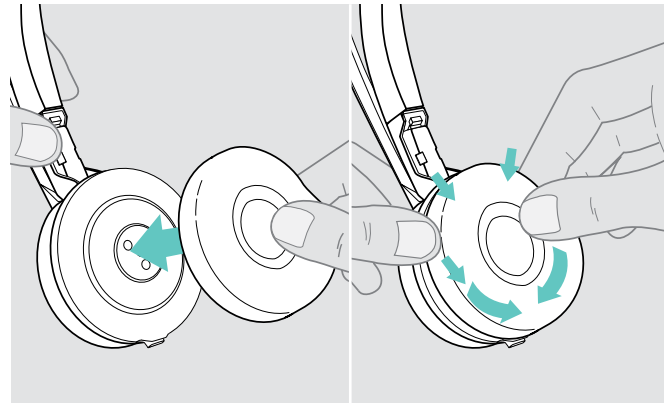

- ▷ Attach the new ear pad to the ear cup by pressing firmly around the ear pad.

Replacing / removing the headset's rechargeable battery

The rechargeable battery may be replaced or removed by any qualified technician of your IT or Service department.

▶ Visit www.eposaudio.com and check the Support pages to get these instructions.

Updating the firmware of the products

You can update the firmware of your headset and dongle by using the free [EPOS Connect](#) software (see page 7).

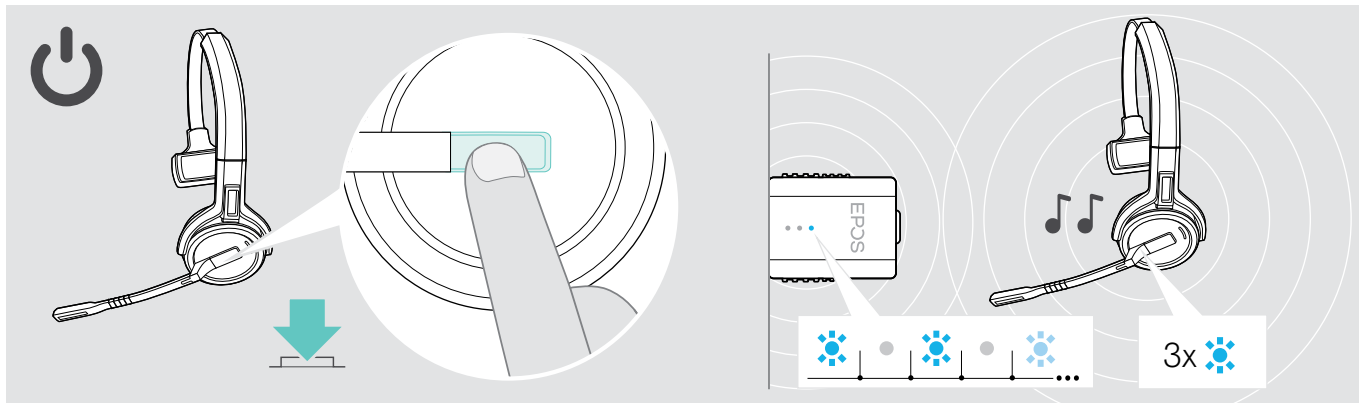

▶ Press the hook button.

The headset switches on and searches for the dongle. If the connection is successful, you hear 2 beeps. The headset LED flashes blue 3 times and the dongle LED lights up dimmed blue.



▶ Start [EPOS Connect](#).

[EPOS Connect](#) checks if the installed firmware is the latest version available on the EPOS server. If required, upgrade to the latest version.

If a problem occurs ...

Problem	Possible cause	Solution	Page
Link between headset and dongle cannot be established	Headset is not paired with the dongle	▷ Pair the dongle and your headset.	8
	Headset has been used with the base station before and searches for the base station instead of the dongle.	▷ Switch to the dongle search.	24
Bad or no connection between headset and dongle	Transmission range is exceeded	▷ Reduce the distance between headset and dongle.	23
		▷ Adjust the radio range in EPOS Connect.	–
Noise interference and connection loss	Dongle not inserted correctly in USB socket of your computer	▷ Plug in the dongle again.	7
	Microphone placed in the wrong position	▷ Adjust the headset so that the microphone is about 0.8 - 1.2" (2 - 3 cm) from the corner of your mouth.	9
Headset battery cannot be charged	Too many DECT systems within the radio range	▷ Reduce the radio range in EPOS Connect.	–
	Charging contacts of the headset or dongle are dirty	▷ Clean the charging contacts.	25
Beeps instead of voice prompts	Rechargeable battery is defective / worn out	▷ Ask a technician to replace the rechargeable battery.	26
	Headset is not properly placed in the magnetic holder of the charging cable or charging stand	▷ Place the headset again into the magnetic holder.	22
The talk time is reduced	Voice prompts are deactivated	▷ Activate the voice prompts.	23
Dropped calls due to high density	Worn-out rechargeable battery	▷ Ask a technician to replace the rechargeable battery.	26
	Large distance between dongle and headset	▷ Reduce the distance if possible. Larger distances require a higher transmission power and reduce the talk time.	–
	Many DECT systems in the same area	▷ Switch off DECT systems that are currently not required. Congestion requires a higher transmission power and reduces the talk time.	–
	Narrowband / wideband setting	▷ Set to narrowband transmission as it requires less power than wideband transmission.	–
Dropped calls due to high density	High density: Too many DECT systems in the same area	▷ Reduce the radio range on all DECT systems in the area.	–
		▷ Reduce audio quality to narrowband.	–

If a problem occurs that is not listed in the above table or if the problem cannot be solved with the proposed solutions, please contact your local EPOS partner for assistance.

To find an EPOS partner in your country, search at www.eposaudio.com.

Specifications

DECT dongle SDW D1 USB

Dimensions (W x H x D)	20.5 x 23 x 8.5 mm / 0.81 x 0.91 x 0.33 in
Weight	5 g / 0.18 oz
DECT frequency range	European Union: 1880 – 1900 MHz United States: 1920 – 1930 MHz
RF Output Power	max. 100 mW (EIRP)

Headset SDW 10 HS

Dimensions (W x H x D)	50 x 25 x 140 mm / 1.97 x 0.98 x 5.51 in
Weight with...	ear hook: 44 g / 1.55 oz headband: 58 g / 2.05 oz neckband: 43 g / 1.52 oz
Talk time	narrowband: up to 10 hours wideband: up to 8 hours
Standby time	48 hours
Charging time	50% approx. 2 hours 100% approx. 4 hours
Range (environment dependent)	free line of sight: up to 135 m / 442 ft in office buildings: up to 40 m / 131 ft
Frequency response speaker	100 Hz – 7.5 kHz
Rechargeable battery (built-in)	Lithium Polymer; 3.7 V; 335 mAh
Output power	European Union: max. 250 mW (EIRP) United States: max. 100 mW (EIRP)
Speaker type	neodymium magnet
Microphone type	Digital MEMs microphone (2 microphones), noise cancelling

Headset SDW 30 HS | Headset SDW 60 HS

Dimensions (W x H x D)	SDW 30 HS: 165 x 165 x 62 mm / 6.50 x 6.50 x 2.44 in SDW 60 HS: 165 x 170 x 62 mm / 6.50 x 6.69 x 2.44 in
Weight	SDW 30 HS: 100 g / 3.52 oz SDW 60 HS: 136 g / 4.80 oz
Talk time	narrowband: up to 14 hours wideband: up to 11 hours
Listening time	wideband: up to 12 hours
Standby time	44 hours
Charging time	50% approx. 3 hours 100% approx. 7 hours
Range (environment dependent)	free line of sight: up to 135 m / 442 ft in office buildings: up to 40 m / 131 ft
Frequency response speaker	50 Hz – 7.5 kHz
Rechargeable battery (built-in)	Lithium Polymer; 3.7 V; 530 mAh
Output power	European Union: max. 250 mW (EIRP) United States: max. 100 mW (EIRP)
Speaker type	neodymium magnet
Microphone type	Digital MEMs microphone (2 microphones), noise cancelling

General data

Temperature range	operation: +5 °C to +45 °C / +41 °F to +113 °F storage: -20 °C to +70 °C / -4 °F to +158 °F
Relative humidity	operation: 20% to 85% storage: 20% to 95%

EPOS

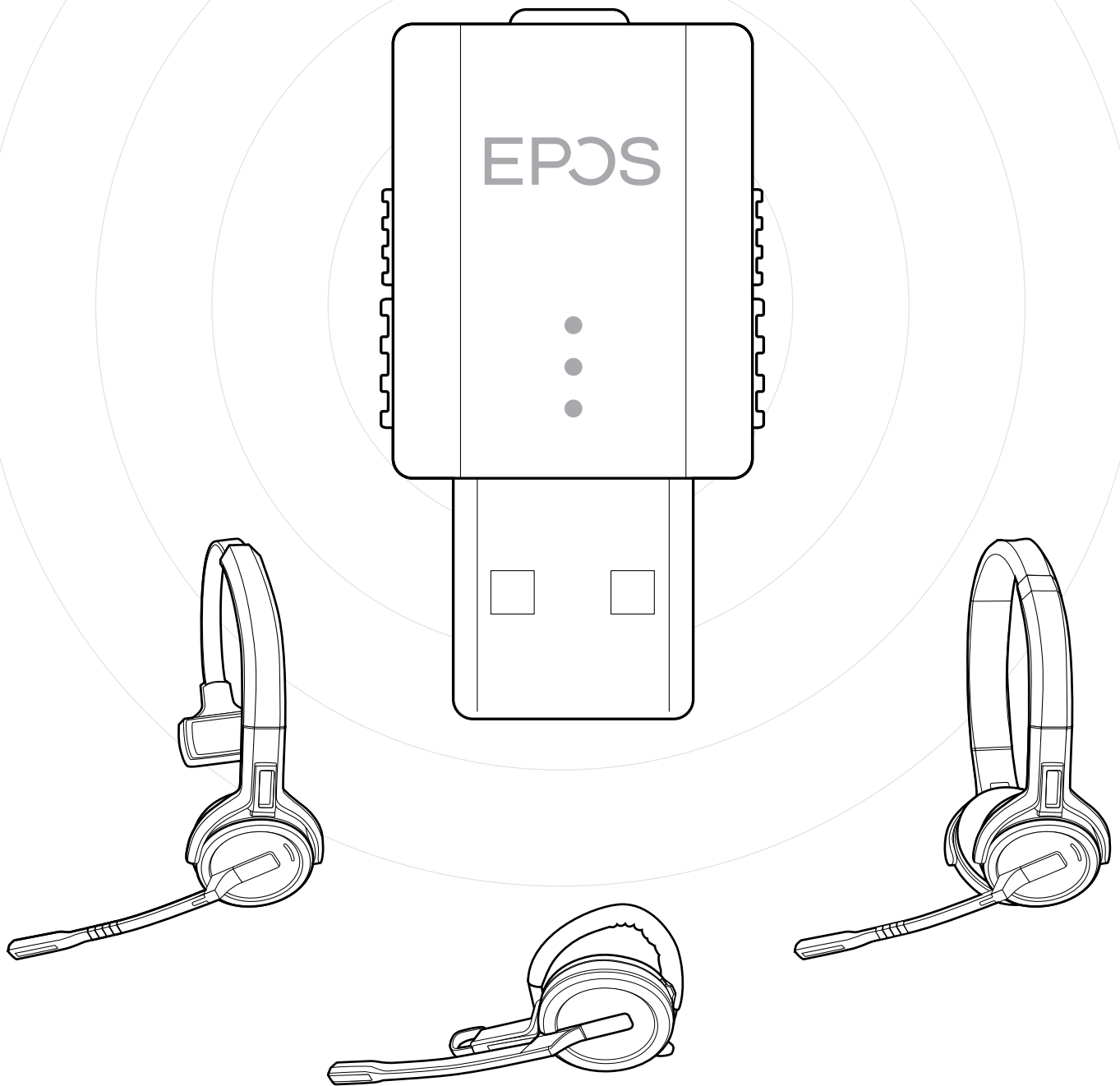

DSEA A/S

Kongebakken 9, DK-2765 Smørum, Denmark
www.eposaudio.com

Publ. 05/21, A03