



ROG STRIX OLED XG27AQDN GAMING MONITOR

USER GUIDE



Copyright © 2025 ASUSTeK COMPUTER INC. All Rights Reserved.

No part of this manual, including the products and software described in it, may be reproduced, transmitted, transcribed, stored in a retrieval system, or translated into any language in any form or by any means, except documentation kept by the purchaser for backup purposes, without the express written permission of ASUSTeK COMPUTER INC. ("ASUS").

Product warranty or service will not be extended if: (1) the product is repaired, modified or altered, unless such repair, modification or alteration is authorized in writing by ASUS; or (2) the serial number of the product is defaced or missing.

ASUS PROVIDES THIS MANUAL "AS IS" WITHOUT WARRANTY OF ANY KIND, EITHER EXPRESS OR IMPLIED, INCLUDING BUT NOT LIMITED TO THE IMPLIED WARRANTIES OR CONDITIONS OF MERCHANTABILITY OR FITNESS FOR A PARTICULAR PURPOSE. IN NO EVENT SHALL ASUS, ITS DIRECTORS, OFFICERS, EMPLOYEES OR AGENTS BE LIABLE FOR ANY INDIRECT, SPECIAL, INCIDENTAL, OR CONSEQUENTIAL DAMAGES (INCLUDING DAMAGES FOR LOSS OF PROFITS, LOSS OF BUSINESS, LOSS OF USE OR DATA, INTERRUPTION OF BUSINESS AND THE LIKE), EVEN IF ASUS HAS BEEN ADVISED OF THE POSSIBILITY OF SUCH DAMAGES ARISING FROM ANY DEFECT OR ERROR IN THIS MANUAL OR PRODUCT.

SPECIFICATIONS AND INFORMATION CONTAINED IN THIS MANUAL ARE FURNISHED FOR INFORMATIONAL USE ONLY, AND ARE SUBJECT TO CHANGE AT ANY TIME WITHOUT NOTICE, AND SHOULD NOT BE CONSTRUED AS A COMMITMENT BY ASUS. ASUS ASSUMES NO RESPONSIBILITY OR LIABILITY FOR ANY ERRORS OR INACCURACIES THAT MAY APPEAR IN THIS MANUAL, INCLUDING THE PRODUCTS AND SOFTWARE DESCRIBED IN IT.

Products and corporate names appearing in this manual may or may not be registered trademarks or copyrights of their respective companies, and are used only for identification or explanation and to the owners' benefit, without intent to infringe.

Contents

Notices.....	iv
Safety Information	v
Care & Cleaning	vi
Takeback Services.....	vii
Chapter 1: Product Introduction	
1.1 Welcome!	1-1
1.2 Package Contents	1-1
1.3 Monitor Introduction	1-2
1.3.1 Front View	1-2
1.3.2 Back View	1-4
1.3.3 GamePlus Function	1-5
1.3.4 GameVisual Function.....	1-9
Chapter 2: Setup	
2.1 Attaching the Stand	2-1
2.2 Cable Management	2-2
2.3 Detaching the Stand (for VESA wall mount).....	2-3
2.4 Connecting the Cables	2-4
2.5 Turning On the Monitor	2-5
2.6 Adjusting the Monitor	2-5
Chapter 3: General Instructions	
3.1 OSD (On-Screen Display) Menu.....	3-1
3.1.1 How to Reconfigure	3-1
3.1.2 OSD Function Introduction.....	3-2
3.2 Specifications.....	3-15
3.3 Outline Dimensions	3-17
3.4 Troubleshooting (FAQ).....	3-18
3.5 Supported Timing List.....	3-19

Notices

Federal Communications Commission Statement

This device complies with Part 15 of the FCC Rules. Operation is subject to the following two conditions:

- This device may not cause harmful interference, and
- This device must accept any interference received including interference that may cause undesired operation.

This equipment has been tested and found to comply with the limits for a Class B digital device, pursuant to Part 15 of the FCC Rules. These limits are designed to provide reasonable protection against harmful interference in a residential installation. This equipment generates, uses and can radiate radio frequency energy and, if not installed and used in accordance with manufacturer's instructions, may cause harmful interference to radio communications. However, there is no guarantee that interference will not occur in a particular installation. If this equipment does cause harmful interference to radio or television reception, which can be determined by turning the equipment off and on, the user is encouraged to try to correct the interference by one or more of the following measures:

- Reorient or relocate the receiving antenna.
- Increase the separation between the equipment and receiver.
- Connect the equipment to an outlet on a circuit different from that to which the receiver is connected.
- Consult the dealer or an experienced radio/TV technician for help.



The use of shielded cables for connection of the monitor to the graphics card is required to assure compliance with FCC regulations. Changes or modifications to this unit not expressly approved by the party responsible for compliance could void the user's authority to operate this equipment.

Canadian Department of Communications Statement

This digital apparatus does not exceed the Class B limits for radio noise emissions from digital apparatus set out in the Radio Interference Regulations of the Canadian Department of Communications.

This class B digital apparatus complies with Canadian ICES-003.

This Class B digital apparatus meets all requirements of the Canadian Interference - Causing Equipment Regulations.

Cet appareil numérique de la classe B respecte toutes les exigences du Règlement sur le matériel brouiller du Canada.



Safety Information

This equipment is not suitable for use in locations where children are likely to be present.

- Before setting up the monitor, carefully read all the documentation that came with the package.
- To prevent fire or shock hazard, never expose the monitor to rain or moisture.
- Never try to open the monitor cabinet. The dangerous high voltages inside the monitor may result in serious physical injury.
- If the power supply is broken, do not try to fix it by yourself. Contact a qualified service technician or your retailer.
- Before using the product, make sure all cables are correctly connected and the power cables are not damaged. If you detect any damage, contact your dealer immediately.
- Slots and openings on the back or top of the cabinet are provided for ventilation. Do not block these slots. Never place this product near or over a radiator or heat source unless proper ventilation is provided.
- The monitor should be operated only from the type of power source indicated on the label. If you are not sure of the type of power supply to your home, consult your dealer or local power company.
- Use the appropriate power plug which complies with your local power standard.
- Do not overload power strips and extension cords. Overloading can result in fire or electric shock.
- Avoid dust, humidity, and temperature extremes. Do not place the monitor in any area where it may become wet. Place the monitor on a stable surface.
- Unplug the unit during a lightning storm or if it will not be used for a long period of time. This will protect the monitor from damage due to power surges.
- Never push objects or spill liquid of any kind into the slots on the monitor cabinet.
- To ensure satisfactory operation, use the monitor only with UL listed computers which have appropriate configured receptacles marked between 100-240V AC.
- If you encounter technical problems with the monitor, contact a qualified service technician or your retailer.

- Adjustment of the volume control as well as the equalizer to other settings than the center position may increase the ear-/headphones output voltage and therefore the sound pressure level.
- CLASS 1 CONSUMER LASER PRODUCT
EN 50689:2021



This symbol of the crossed out wheeled bin indicates that the product (electrical, electronic equipment, and mercury-containing button cell battery) should not be placed in municipal waste. Please check local regulations for disposal of electronic products.

AEEE yönetmeliğine uygundur

Care & Cleaning

- Before you lift or reposition your monitor, it is better to disconnect the cables and power cord. Follow the correct lifting techniques when positioning the monitor. When lifting or carrying the monitor, grasp the edges of the monitor. Do not lift the display by the stand or the cord.
- Cleaning. Turn your monitor off and unplug the power cord. Clean the monitor surface with a lint-free, non-abrasive cloth. Stubborn stains may be removed with a cloth dampened with mild cleaner.
- Avoid using a cleaner containing alcohol or acetone. Use a cleaner intended for use with the OLED. Never spray cleaner directly on the screen, as it may drip inside the monitor and cause an electric shock.

The following symptoms are normal with the monitor:

- The screen may flicker during the initial use due to the nature of the fluorescent light. Turn off the Power Switch and turn it on again to make sure that the flicker disappears.
- You may find slightly uneven brightness on the screen depending on the desktop pattern you use.
- When the same image is displayed for hours, an afterimage of the previous screen may remain after switching the image. The screen will recover slowly or you can turn off the Power Switch for hours.
- When the screen becomes black or flashes, or cannot work anymore, contact your dealer or service center to fix it. Do not repair the screen by yourself!

Conventions used in this guide



WARNING: Information to prevent injury to yourself when trying to complete a task.



CAUTION: Information to prevent damage to the components when trying to complete a task.



IMPORTANT: Information that you **MUST** follow to complete a task.



NOTE: Tips and additional information to aid in completing a task.

Where to find more information

Refer to the following sources for additional information and for product and software updates.

1. **ASUS websites**

The ASUS websites worldwide provide updated information on ASUS hardware and software products. Refer to <http://www.asus.com>

2. **Optional documentation**

Your product package may include optional documentation that may have been added by your dealer. These documents are not part of the standard package.

3. **About Flicker**

https://www.asus.com/Microsite/display/eye_care_technology/

4. **Product information for EU Energy label**



XG27AQDNG

Takeback Services

ASUS recycling and takeback programs come from our commitment to the highest standards for protecting our environment. We believe in providing solutions for our customers to be able to responsibly recycle our products, batteries and other components as well as the packaging materials.

Please go to <http://csr.asus.com/english/Takeback.htm> for detail recycling information in different region.

HDMI[™]
HIGH-DEFINITION MULTIMEDIA INTERFACE

The Adopted Trademarks HDMI, HDMI High-Definition Multimedia Interface, HDMI trade dress and the HDMI Logos are trademarks or registered trademarks of HDMI Licensing Administrator, Inc. in the United States and other countries.

1.1 Welcome!

Thank you for purchasing the ASUS® OLED Gaming monitor!

The latest widescreen OLED monitor from ASUS provides a crisper, broader, and brighter display, plus a host of features that enhance your viewing experience.

With these features, you can enjoy the convenience and delightful visual experience that the monitor brings to you!

1.2 Package Contents

Check your package for the following items:

- ✓ OLED Monitor
- ✓ Quick Start Guide
- ✓ Warranty Card
- ✓ Power Cord
- ✓ ROG Pouch
- ✓ ROG Sticker
- ✓ Monitor Base
- ✓ Wall Mount Kit
- ✓ Microfiber Cloth
- ✓ HDMI cable (optional)
- ✓ DP cable (optional)
- ✓ USB cable (optional)









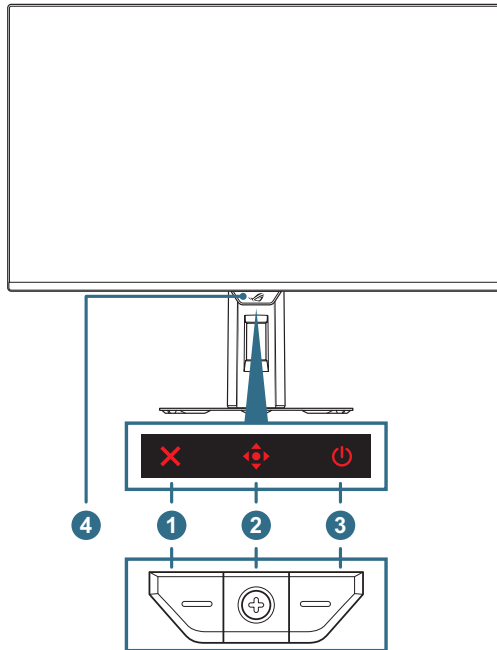

If any of the above items is damaged or missing, contact your retailer immediately.

1.3 Monitor Introduction







1.3.1 Front View



1. **✗ Close button:**
 - When the OSD menu is OFF, press the    button to activate the **Pixel Cleaning** hotkey.
 - When the OSD menu is ON, press to exit the OSD menu.
2. **⬆️ Control buttons:**
 - a. When the OSD menu is OFF:
 - Press the  button to activate the OSD menu.
 - Move the  button right to activate the **GamePlus** hotkey.
 - Move the  button left to activate the **Volume (Earphone Out)** hotkey.
 - Move the  button up to activate the **GameVisual** hotkey.
 - Move the  button down to activate the **Input Select** hotkey.



To change the preset hotkey function, go to the **MyFavorite > Shortcut** menu.

- b. When the OSD menu is ON:
 - Press the  button to enact the selected OSD menu item.
 - Move the  button right to enter the submenu.
 - Move the  button left to return to the previous menu or exit the menu.
 - Move the  button up to move your selection up or increase value.
 - Move the  button down to move your selection down or decrease value.
3.  **Power button:** Turn the monitor on/off.
4. **Neo proximity sensor:** Measure the distance between the user and monitor.

1.3.2 Back View

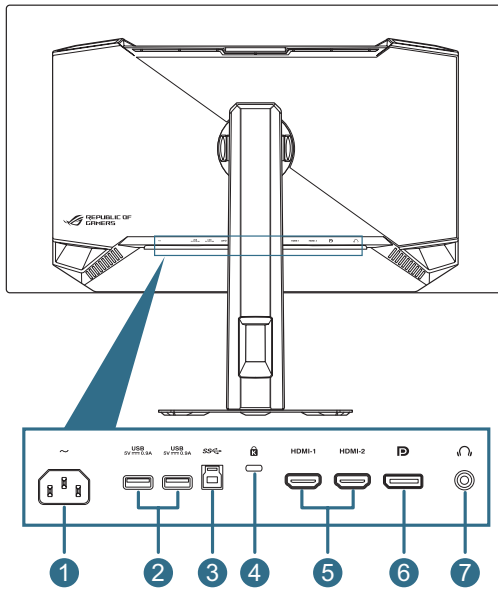









1. **AC-IN port:** This port connects the power cord.
2. **USB3.2 Gen 1 downstream ports:** When the upstream port is connected. The connection enables the USB 3.2 port on the monitor and power delivery 5V/0.9A.
3. **USB3.2 Gen 1 upstream port:** This port is for connection with a USB upstream cable. The connection enables the USB hub function on the monitor.
4. **Kensington lock slot**
5. **HDMI ports:** This port is for connection with an HDMI 2.1 compatible device.
6. **DisplayPort:** This port is for connection with a DisplayPort 1.4 compatible device.
7. **Earphone jack:** This port is connection with an Earphone (Impedance: 32Ω at 1 kHz)

1.3.3 GamePlus Function

The GamePlus function provides a toolkit and creates a better gaming environment for users when playing different types of games. The crosshair overlay with several crosshair options letting you choose the one that best suits the game you're playing. There are also on screen timer and stopwatch you can position on the left of the display so you can keep track of the gaming time; while the FPS (frames per second) counter lets you know how smooth the game is running. Sniper function (only available when HDR is disabled on your device) is customized for first-person shooters. You can select the magnification ratio and the type of alignment in sequence.

To activate GamePlus:

1. Move the  button right.
2. Move the  button up/down to select among different functions.
3. Press the  button or move the  button right to confirm the function you choose, and move the  button up/down to navigate through the settings. Move the  button left to go back, off, or exit.
4. Highlight the desired setting and press the  button to activate it. Press the  button to inactivate it.

GamePlus Main Menu

GamePlus — FPS Counter

GamePlus — Crosshair (Dynamic Crosshair: Automatically adjusts the crosshair color to a highly contrasting color against the background, making it more prominent for more accurate targeting)

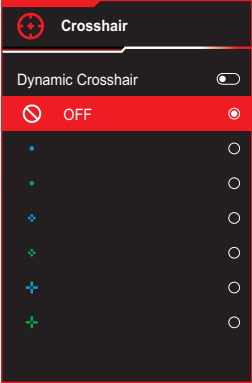
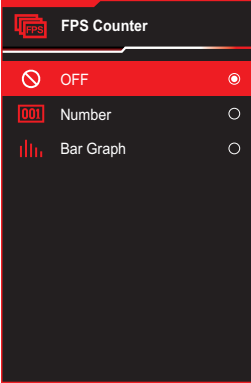

GamePlus — Sniper

GamePlus — Timer

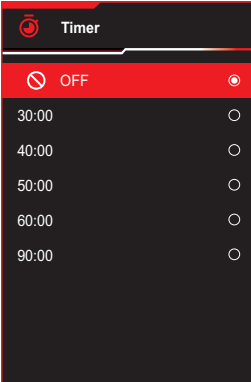
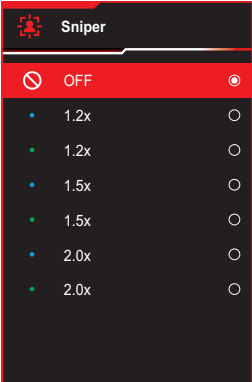

GamePlus — Timer



GamePlus — Stopwatch

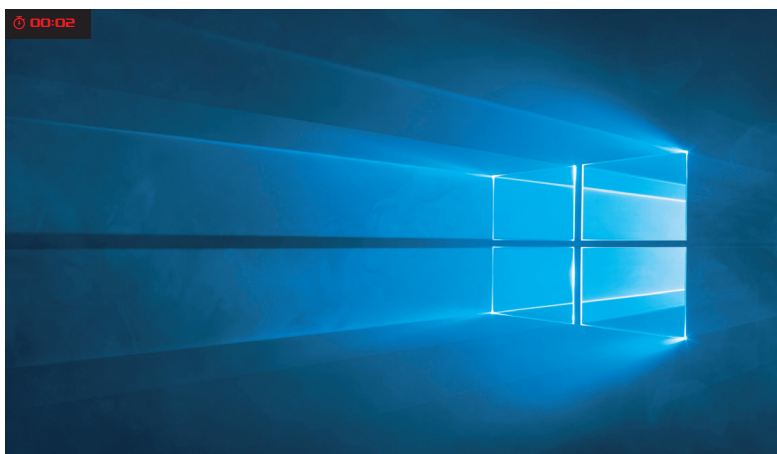

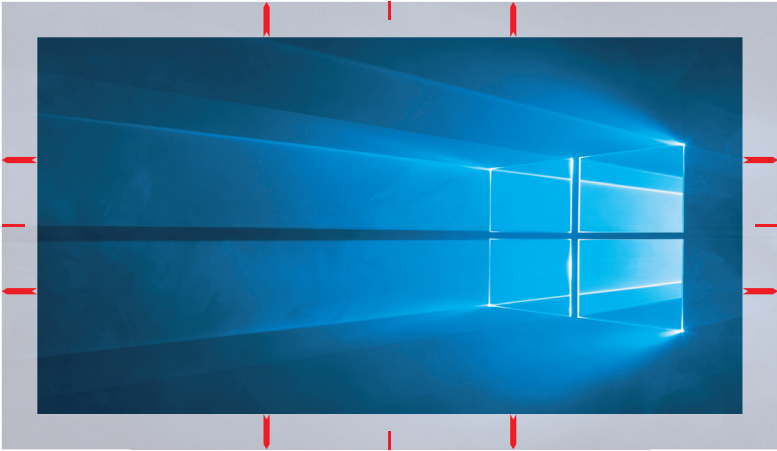

GamePlus — Display Alignment



1.3.4 GameVisual Function

The GameVisual function helps you select among different picture modes in a convenient way.

To activate GameVisual:

1. Press the GameVisual shortcut button.
2. Move the  button up/down to select the desired setting.
 - **Scenery Mode:** This is the best choice for scenery photo displaying with GameVisual™ Video intelligence Technology.
 - **Racing Mode:** This is the best choice for racing game playing with GameVisual™ Video intelligence Technology.
 - **Cinema Mode:** This is the best choice for movie watching with GameVisual™ Video intelligence Technology.
 - **RTS/RPG Mode:** This is the best choice for Real-Time Strategy (RTS)/ Role-Playing Game (RPG) playing with GameVisual™ Video intelligence Technology.
 - **FPS Mode:** This is the best choice for First Person Shooter game playing with GameVisual™ Video intelligence Technology.
 - **sRGB Cal Mode:** This is the best choice for viewing photos and graphics from PCs.
 - **MOBA Mode:** This is the best choice for Multiplayer Online Battle Arena (MOBA) games playing with GameVisual™ Video intelligence Technology.
 - **Night Vision:** This is the best choice for dark scenery playing GameVisual™ Video intelligence Technology.
 - **User Mode:** More items are adjustable in the Color menu.
3. Press the  button to activate the setting.



-
- In the sRGB Cal mode, the following function(s) are not user-configurable: Shadow Boost, Uniform Brightness, Contrast, Blue Light Filter, Display Color Space, Color Temp., Saturation, Six-axis Saturation, Gamma.
 - In the MOBA Mode, the following function(s) are not user-configurable: Shadow Boost, VividPixel, Saturation, Six-axis Saturation.
 - In the Night Vision mode, the following function(s) are not user-configurable: Saturation, Six-axis Saturation.
-

2.1 Attaching the Stand

1. Align and install the base to the stand. Then fix the base to the stand by fastening the bundled screw.
2. Align and install the stand to its compartment on the rear of the monitor.
3. Carefully remove the monitor from the EPS packaging.
4. Place the monitor on a stable surface in the upright position.

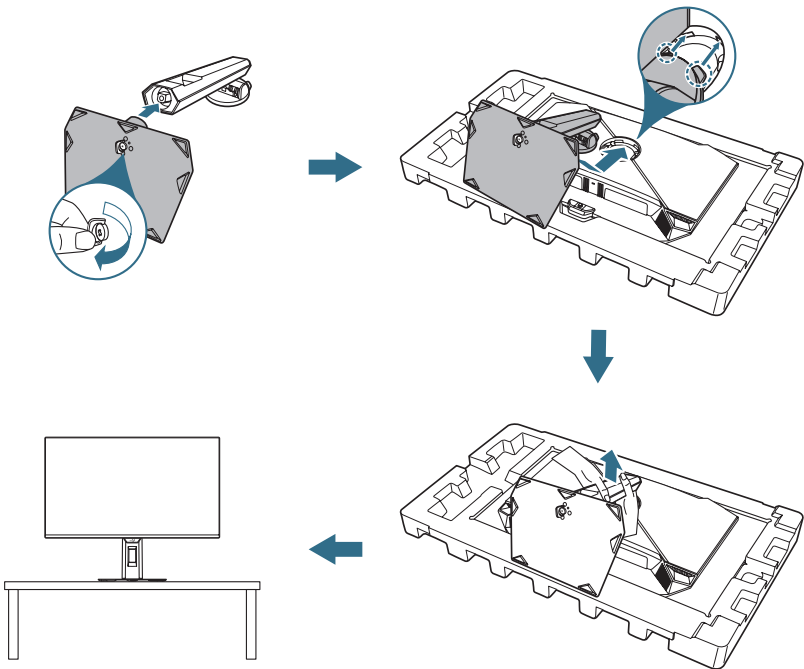

2.2 Cable Management

You can organize the cables by arranging them as shown in the illustration below:

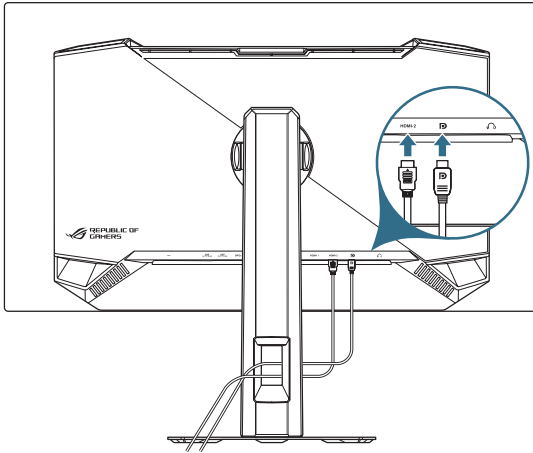

2.3 Detaching the Stand (for VESA wall mount)

The detachable stand of this monitor is specially designed for VESA wall mount.

1. Press the release button to detach the stand from the monitor. Then remove the stand.
2. Install the wall mount bracket on the rear of the monitor.
3. Install VESA wall mount kit if you need to use VESA wall mount.

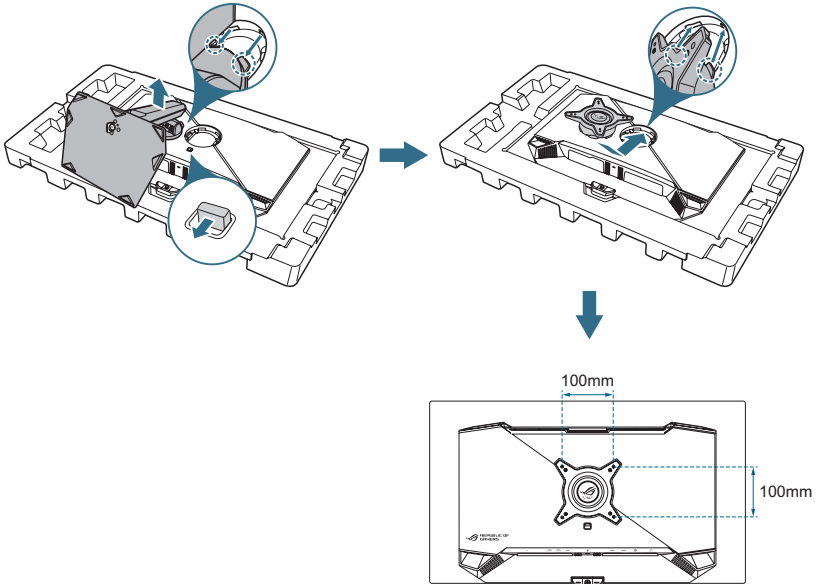

- The VESA wall mount kit (100 x 100 mm) is purchased separately.
- Use only the UL Listed Wall Mount Bracket with minimum weight/load 22.7kg.
- Mounting screw size is M4 x 8 mm (4pcs).

2.4 Connecting the Cables

Connect the cables as the following instructions:

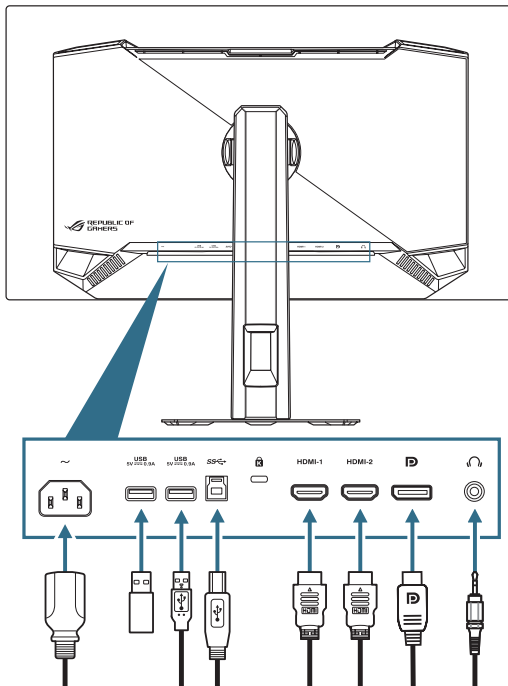

- **To connect the power cord:** Connect one end of the power cord to the monitor's AC IN input and the other end to a power outlet.
- **To use the USB Type-A/B ports:** Take the supplied USB 3.2 cable, and plug the smaller end (Type-B) of the USB upstream cable to the monitor's USB upstream port, and the larger end (Type-A) to your computer's USB 3.2 port. Make sure your computer is installed with the latest Windows 10/ Windows 11 operating system. That will enable the USB hub function on the monitor to work.
- **To connect the DisplayPort/HDMI cable:**
 - a. Plug one end of the DisplayPort/HDMI cable to the monitor's DisplayPort/ HDMI/ port.
 - b. Connect the other end of the DisplayPort/HDMI cable to your computer's DisplayPort/HDMI port.
- **To use the earphone:** Connect the end with 3.5mm audio jack to the monitor's earphone jack.

2.5 Turning On the Monitor

Press the  button on the monitor to turn on the monitor.

If the Power Indicator function is enabled and an input source is detected, the power LED will light up red to indicate that the monitor is turned on.

You can also press any button to turn on the monitor when the monitor is turned off.

2.6 Adjusting the Monitor

- For optimal viewing, we recommend that you look at the full face of the monitor, then adjust the monitor to the angle that is most comfortable for you.
- Hold the stand to prevent the monitor from falling when you change its angle.
- You can adjust the monitor's angle from -5° to 20° and it allows 45° swivel adjustment from either left or right. You can also adjust the monitor's height within ± 110 mm and rotate the monitor (90° clockwise or counter-clockwise) to portrait orientation.

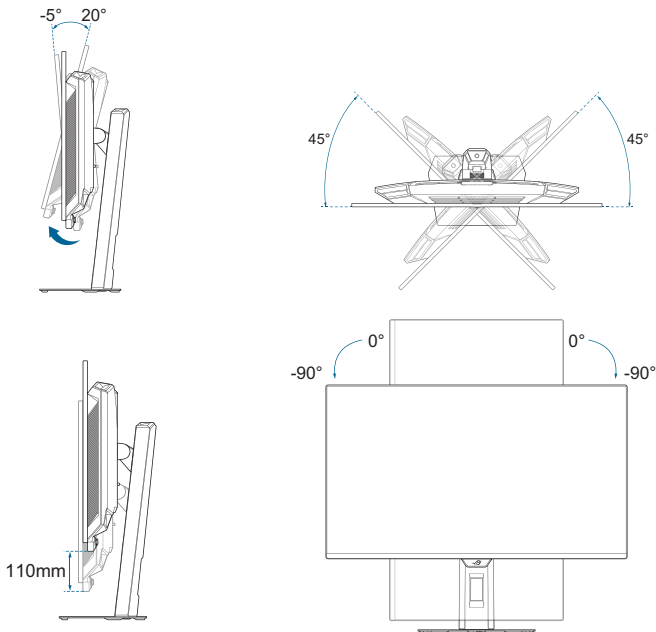







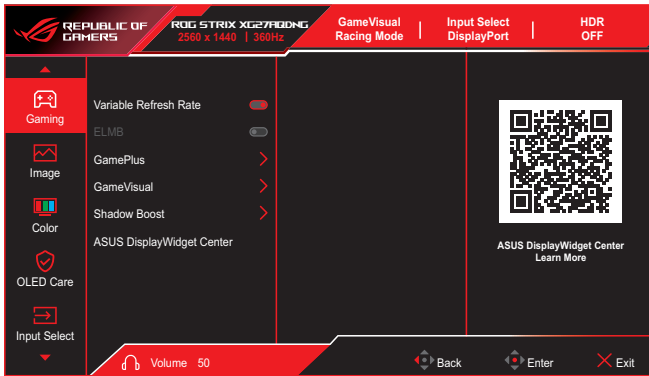

3.1 OSD (On-Screen Display) Menu

3.1.1 How to Reconfigure

Use the control buttons on the monitor to navigate through the menu and make adjustments.



To navigate through the menu and make adjustments, do the following:

1. Press the  button to activate the OSD menu.
2. Move the  button up/down to navigate through the functions. Highlight the desired function and press the  button to activate it. If the function selected has a sub-menu, move the  button up/down again to navigate through the sub-menu functions. Highlight the desired sub-menu function and press the  button or move the  button right to activate it.
3. Move the  button up/down to change the settings of the selected function.
4. To exit and save the OSD menu, press the  button or move the  button left repeatedly until the OSD menu disappears. To adjust other functions, repeat steps 1 to 3.

3.1.2 OSD Function Introduction

1. Gaming

Configure your gaming preferences.

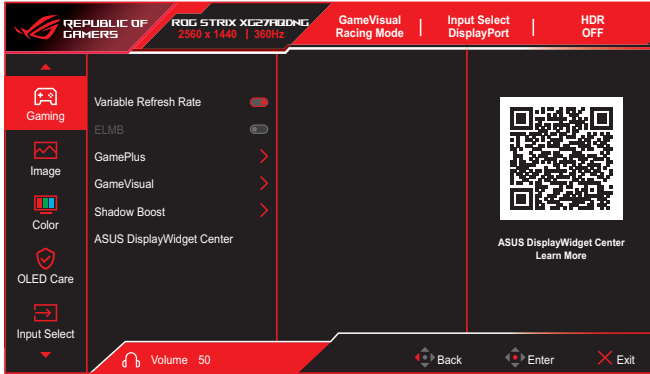

- **Variable Refresh Rate:** Allows an Variable Refresh Rate supported graphics source to dynamically adjust display refresh rate based on typical content frame rates for power efficient, virtually stutter free and low-latency display update.



- This function can only be activated within 48Hz~360Hz for HDMI and DisplayPort.
- For supported GPUs, minimum PC system and driver requirements, please contact the GPU manufactures.
- The following function will be disabled when Variable Refresh Rate turn on.
 - ELMB

- **ELMB:** Configure the ELMB related settings. This function eliminates screen tearing, reduces ghosting and motion blur when playing games.



- To activate ELMB, turn off Variable Refresh Rate function first.
- The following function will be disabled when ELMB turn on.
 - Variable Refresh Rate
 - Blue Light Filter
 - Aspect Control
 - Brightness
 - Uniform Brightness
 - HDR Setting
 - Sniper
 - Auto Logo Brightness
- This function is only available when the refresh rate is 120Hz & 180 Hz.

- **GamePlus:** Configure the gaming environment.
See 1.3.3 GamePlus Function for details.
- **GameVisual:** Select the picture mode.
See 1.3.4 GameVisual Function for details.



When HDR function is turned on, Game Visual will be disabled.

- **Shadow Boost:** Adjust the monitor gamma curve to enrich the dark tones in an image, making dark scenes and objects much easier to be seen.
 - **Dynamic Shadow Boost:** Automatically enhances dark areas in scenes, making it easier to spot enemies hiding in dimly lit areas of the map.
- **ASUS DisplayWidget Center:** Display a QR code for you to access the information about ASUS DisplayWidget Center.

2. Image

Configure the image settings.

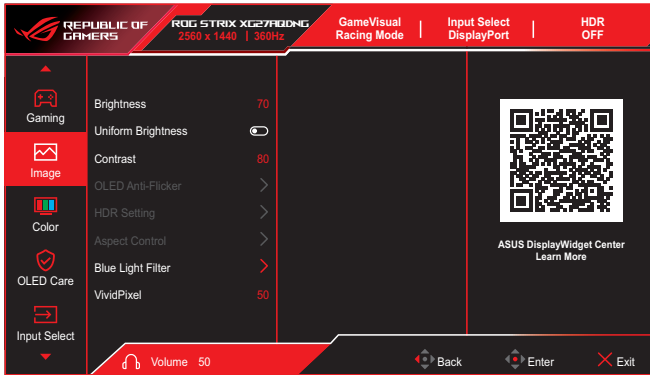

- **Brightness:** Adjust the brightness level.
- **Uniform Brightness:** With the feature enabled, the system will not adjust the maximum brightness of the screen when the screen is displayed in a different screen size.
- **Contrast:** Adjust the contrast level.
- **OLED Anti-Flicker:** Designed to enhance your viewing experience by stabilizing the refresh rate within a specified range.



-
- OLED Anti-Flicker only supports in the limited refresh rate.
 - This function is only available when the input source is DisplayPort.
-

- **HDR Setting:** Set the HDR mode to Gaming HDR, Cinema HDR, Console HDR, DisplayHDR 400 True Black, Adjustable HDR, or Dynamic Brightness Boost.
If the setting is set to **Adjustable HDR**, HDR PQ curve will be affected.



- The following function will be disabled when HDR turn on.
 - ELMB
 - GameVisual
 - Shadow Boost
 - Contrast
 - Blue Light Filter
 - Color Temp.
 - Gamma
 - Saturation
 - Power Saving
 - Display Color Space
 - Six-axis Saturation
 - Sniper
 - Uniform Brightness
-

- **Aspect Control:** Select the aspect ratio and adjust the screen position.



- The following function will be disabled when Aspect Control turn on.
 - ELMB
-

- **Blue Light Filter:** Reduce the energy level of blue light emitted from the harmful blue light.

- **OFF:** No change.
- **Level 1~4:** The higher the level, the less blue light is scattered. When Blue Light Filter is activated, the default settings of Racing Mode will be automatically imported.
 - ✦ Between Level 1 to Level 3, the Brightness function is user-configurable.
 - ✦ Level 4 is optimized setting. The Brightness function is not user-configurable.



-
- The **ELMB** function will be disabled when **Blue Light Filter** is turned on.
 - The monitor uses low blue light panel and compliance with TUV Rheinland Low Blue Light Hardware Solution at factory reset/default setting mode.
-



Please refer to the following to alleviate eye strains:

- Users should take some time away from the display if working for long hours. It is advised to take short breaks (at least 5 mins) after around 1 hour of continuous working at the computer. Taking short and frequent breaks is more effective than a single longer break.
 - To minimize eye strain and dryness in your eyes, users should rest the eye periodically by focusing on objects that are far away.
 - Eye exercises can help to reduce eye strain. Repeat these exercises often. If eye strain continues please consult a physician. Eye exercises: (1) Repeating look up and down (2) Slowly roll your eyes (3) Move your eyes diagonal.
 - High energy blue light may lead to eye strain and AMD (Age-Related Macular Degeneration). Blue light filter to reduce 70% (max.) harmful blue light to avoiding CVS (Computer Vision Syndrome).
-
- **VividPixel:** Enhance the outline of the displayed picture and generates high-quality images on screen.

3. Color

Configure the image color settings.

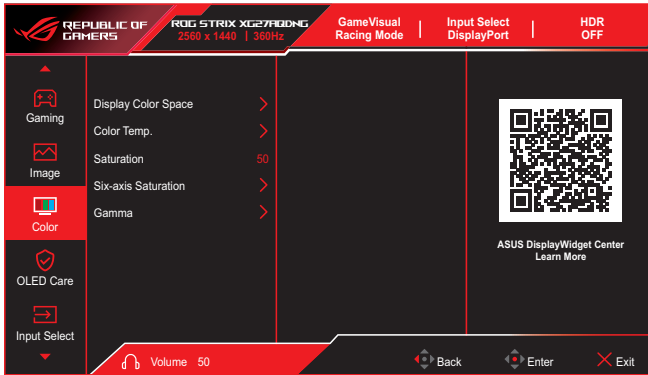

- **Display Color Space:** Select the color space for the monitor color output.
- **Color Temp.:** Contain 8 modes including 4000K, 5000K, 6500K, 7500K , 8200K, 9300K, 10000K and User mode.
- **Saturation:** Adjust the saturation level.
- **Six-axis Saturation:** Adjust the saturation for R, G, B, C, M, Y.
- **Gamma:** Allow you to set the color mode to 1.8, 2.0, 2.2, 2.4 and 2.6.

4. OLED Care

Configure the screen protection related settings.

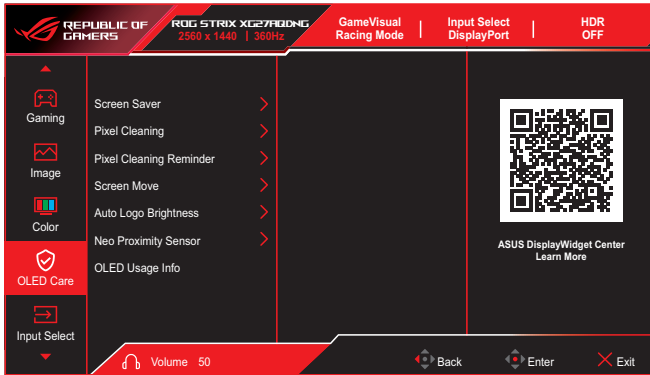

- **Screen Saver:** Enable/Disable the screen saver function. The screen brightness will automatically decrease when there is no change on the screen.
- **Pixel Cleaning:** It calibrates any issues that may arise on the screen when your monitor has been turned on for a long time. The process will take approximately 4 minutes. This function will automatically activate when the monitor is turned off. Do not unplug the power cord while it is in progress. If you power on the monitor, the Pixel Cleaning will stop operating.
- **Pixel Cleaning Reminder:** Set a reminder for user to perform the Pixel Cleaning.



The screen may have mura and image sticking due to OLED characteristic during the initial use or re-used after a long time. It is advised to perform Pixel Cleaning while turning on monitor to make sure situation disappear.

- **Screen Move:** Select the screen movement level to prevent image sticking on the display panel.
- **Auto Logo Brightness:** Enable this function to allow the system to automatically adjust the logo brightness to correct the potential picture quality issues.

- **Neo Proximity Sensor:** If the function is enabled and the system does not detect the presence of object within 60 cm – 120 cm (depending on your selection) over the present time, the monitor will apply Screen-off.
Screen off time can be set as 5 minutes, 10 minutes, or 15 minutes.
- **Tailored mode:** Allows users to customize the Neo Proximity Sensor detection distance. It is recommended to set the distance within 120cm. After a set period of time, the monitor will apply Screen-off.



-
- The angle and placement of the monitor sensor might affect the signal detection results.
 - Before using the sensor, make sure the sensor window is clean and free of dirt, and ensure that no objects are covering the sensor window.
 - Before use, please spray pure water on the included microfiber cloth and wipe the logo plate sensor window.
 - If the sensor does not detect motion within its detection range during the setting time, the screen will perform a screen-off and display a black screen to protect the screen and prevent burn-in, which is a normal phenomenon.
 - It is recommended that players disable this feature during near-static activities to prevent the sensor from detecting no movement within its range, which could cause the screen to display a black screen and negatively impact the user experience.
-
- **OLED Usage Info:** Record the number of times the Pixel Cleaning has been performed and displays the Pixel Cleaning interval information.

5. Input Select

Select your desired input source and toggle the Auto Input Detection function between on and off. The monitor input source will not automatically switch when the Auto Input Detection function is disabled.



6. Lighting Effect

Configure the lighting effect for the rear cover and base cover.



- **Aura Sync:** Allow you to turn on or off the Aura Sync function that synchronizes the Aura RGB light effect among all supported devices.



The **Aura RGB** function will be disabled when **AURA Sync** is turned on.

- **Aura RGB:** There are five living colors that can be chosen: **Rainbow**, **Color Cycle**, **Static**, **Breathing**, **Strobing**, and **OFF**. You can manually change the R/G/B/C/M/Y color for **Static**, **Breathing**, and **Strobing** modes.



The **Aura Sync** function will be disabled when **AURA RGB** is turned on.

7. MyFavorite

Assign a function to the shortcut button, save the current system configurations, or restore the system configuration.

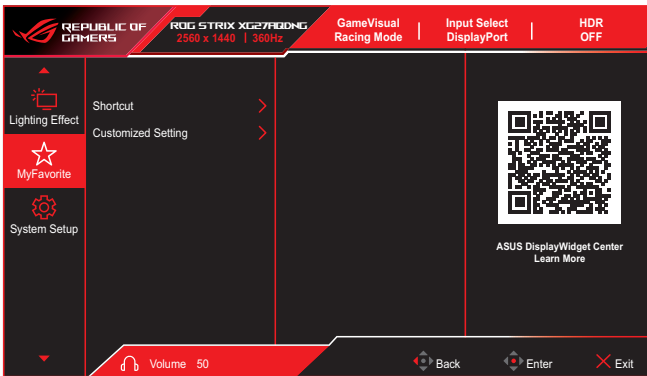

- **Shortcut:** Assign a function for the designated shortcut button.
- **Customized Setting:** Load/Save all settings on the monitor.

8. System Setup

Adjust the system configurations.

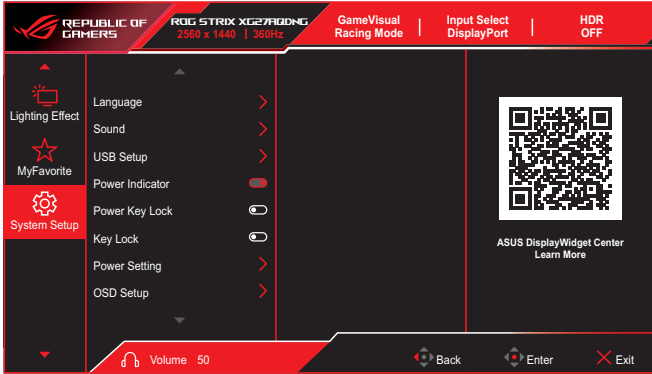

- **Language:** Select the OSD language.
- **Sound:** Configure the sound related settings.
 - **Volume (Earphone Out):** Adjust the volume level.
 - **Mute:** Enable/Disable the mute function.
- **USB Setup:** Configure the USB port settings.
 - **USB Hub:** Set the USB Hub availability during standby.
- **Power Indicator:** Turn the power LED indicator on/off.
- **Power Key Lock:** Disable/Enable the Power key.
- **Key Lock:** To disable all function keys. Press and hold the  button downward for more than five seconds to cancel the key lock function.
- **Power Setting:** Select the power setting mode. If the setting is set to **Performance Mode**, it may result in higher power consumption. On the other hand, if the setting is set to **Power Saving Mode**, it may cause limited luminance performance.
- **OSD Setup:** Configure the OSD menu related settings.
 - **OSD Position:** Set the OSD menu position.
 - **OSD Timeout:** Adjust the OSD timeout.
 - **Transparency:** Adjust the OSD background from opaque to transparent.
 - **DDC/CI:** Enable/Disable the DDC/CI function.



DDC/CI option can be adjusted when VRR is OFF.

- **DisplayPort Stream:** Compatibility with graphic card. Select DisplayPort 1.2, or DisplayPort 1.4 by graphic card supported DP version.
- **DSC Support:** Enable/Disable the DSC (Display Stream Compression) function.
- **ASUS Power Sync:** Allow the power on/off control of the console device or setup box, such as Apple TV, Sony PlayStation, Xbox Series X/S, Nintendo Switch through the monitor. The default setting is **OFF**. If the monitor is turned on, the CEC source device will automatically power on, and vice versa. If the CEC source device is turned on, the monitor will automatically power on.
- **Information:** Display the monitor information.
- **All Reset:** Select **Yes** to revert all settings to the factory default mode.

3.2 Specifications

Panel type	360Hz
Panel size	26.5"
Max. resolution	2560 x 1440
Brightness	250nits (typ.)
Contrast ratio	1.5M:1
Viewing angle (H/V)	178°(H) / 178°(V)
Display colors	10 bit
Response time	0.03ms
Color temperature selection	9 modes(GameVisual: Scenery, Racing, Cinema, RTS/RPG, FPS, sRGB Cal, MOBA, Night Vision, User)
Analog input	No
Digital input	DisplayPort v1.4 x1 HDMI v2.1 x2 USB Type-A x2 USB Type-B x1
Earphone jack	Yes
SPDIF out	No
Speaker (Built-in)	No
USB3.2 Gen 1 port	Downstream: USB Type-A x2 (5V/0.9A) Upstream: USB Type-B x1
USB2.0 port	No
Colors	Black
Power LED	Red (On) Orange (Standby)
Tilt	-5° to 20°
Swivel	±45°
Pivot	±90°
Height adjustment	0 to 110 mm
VESA wall mount	100 x 100 mm
Kensington lock	Yes
Voltage rating	AC 100-240V, 50/60Hz
Power consumption	Power On: < 60W** Power saving: < 0.5W Power Off: < 0.3W
Temperature (Operating)	0°C to 40°C
Temperature (Non-operating)	-20°C to 60°C

Dimensions (W x H x D)	611.1(W) x 395.2(H) x 169.4(D)mm (with stand, lowest) 611.1(W) x 502.5(H) x 169.4(D)mm (with stand, highest) 611.1(W) x 369.6(H) x 66.5(D)mm (without stand)
Package dimensions (W x H x D)	860 X 500 X 163 mm
Weight	4.6±0.5KG(without stand) 6.6±0.5KG(with stand) 9.2±0.5KG(Gross)
Multi-languages	23 languages (English, French, German, Spanish, Italian, Dutch, Russian, Polish, Czech, Croatian, Hungary, Romania, Portuguese, Turkey, Simplified Chinese, Traditional Chinese, Japanese, Korean, Persian, Thai, Indonesian, Ukrainian, Vietnamese)
Compliance and Standards	cTUVus, FCC, ICES-003, FDA, CB, CE, ErP, UkrSEPRO, Ukraine Energy, CU, CCC, CEL, BSMI, RCM, AU_MEPS, VCCI, PSE, J-MOSS, RoHS, WEEE, Windows 10/11 WHQL, KC, KCC, E-STANDBY, PSB, VN_MEPS, TUV-Flicker Free, TUV-Low Blue Light, CEC, SIOC

*Specifications subject to change without notice.

** Measuring a screen brightness of 200 nits without audio/ USB/ card reader connections.

3.3 Outline Dimensions

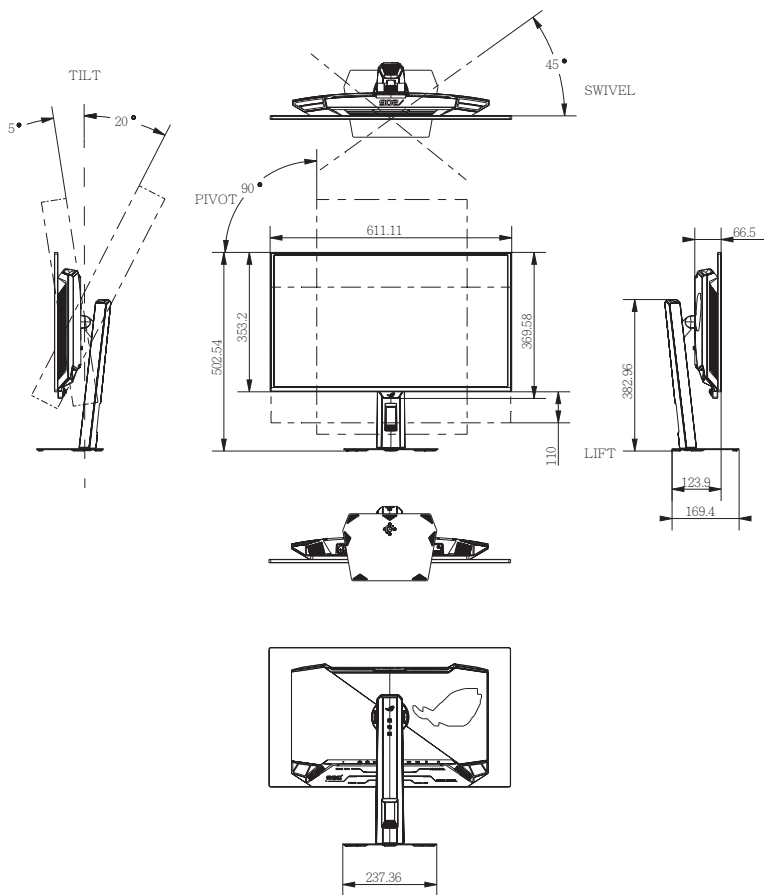

3.4 Troubleshooting (FAQ)

Problem	Possible Solution
Power LED is not ON	<ul style="list-style-type: none">• Press any button to check if the monitor is in the ON mode.• Check if the power cord is properly connected to the monitor and the power outlet.• Check the Power Indicator function in the OSD menu. Select “ON” to turn on the power LED.
How do I set the monitor's refresh rate to the highest value as the monitor spec claimed	<ul style="list-style-type: none">• Gaming considerations: Ensure the game titles you are playing support the range• GPU: It is recommended to use NVIDIA RTX 40 series or an AMD RX 7000 series graphic card.• CPU: It is recommended to use a CPU from the 14th generation Intel or AMD Ryzen 7000 series or newer.
The power LED lights red and there is no screen image	<ul style="list-style-type: none">• Check if the monitor and the computer are turned on.• Make sure the signal cable is properly connected the monitor and the computer.• Inspect the signal cable and make sure none of the pins are bent.• Connect the computer with another available monitor to check if the computer is properly working.
Screen image is too light or dark	<ul style="list-style-type: none">• Adjust the Contrast and Brightness settings via OSD.
Screen image bounces or a wave pattern is present in the image	<ul style="list-style-type: none">• Make sure the signal cable is properly connected to the monitor and the computer.• Move electrical devices that may cause electrical interference.
Screen image has color defects (white does not look white)	<ul style="list-style-type: none">• Inspect the signal cable and make sure that none of the pins are bent.• Perform All Reset via OSD.• Select the appropriate color temperature (Color Temp.) via OSD.
HDR content is not played properly	<ul style="list-style-type: none">• Make sure the input source supports HDR playback (with proper system settings and latest software).• Make sure the content is HDR encoded.

3.5 Supported Timing List

Supporting Timing

HDMI	DP
640x480@60Hz	640x480@60Hz
640x480@75Hz	640x480@75Hz
800x600@60Hz	800x600@60Hz
800x600@75Hz	800x600@75Hz
1024x768@60Hz	1024x768@60Hz
1024x768@75Hz	1024x768@75Hz
1280x960@60Hz	1280x960@60Hz
1280x1024@60Hz	1280x1024@60Hz
1280x750@60Hz	1280x750@60Hz
1600x1200@60Hz	1600x1200@60Hz
1920x1080@60Hz	1920x1080@60Hz
2560x1440@60Hz	2560x1440@60Hz
720x480@60Hz	720x480@60Hz
720x576@50Hz	720x576@50Hz
1280x720@50Hz	1280x720@50Hz
1280x720@60Hz	1280x720@60Hz
1920x1080@24Hz	1920x1080@24Hz
1920x1080@25Hz	1920x1080@25Hz
1920x1080@30Hz	1920x1080@30Hz
1920x1080@50Hz	1920x1080@50Hz
1920x1080@60Hz	1920x1080@60Hz
1920x1080@100Hz	1920x1080@100Hz
1920x1080@120Hz	1920x1080@120Hz
3840x2160@24Hz	2560x1440@120Hz
3840x2160@25Hz	2560x1440@144Hz
3840x2160@30Hz	2560x1440@180Hz
3840x2160@50Hz	2560x1440@360Hz
3840x2160@60Hz	1920x1080@240Hz
3840x2160@100Hz	1920x1080@360Hz
3840x2160@120Hz	
2560x1440@120Hz	
2560x1440@144Hz	
2560x1440@180Hz	
2560x1440@360Hz	
1920x1080@240Hz	
1920x1080@360Hz	



REPUBLIC OF
GAMERS

