

Power cord

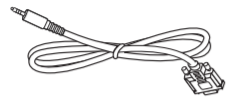

RS232

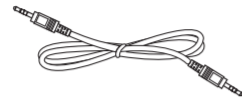

RS232 Daisy Chain Cable



Logo



x 8



x 2



x 1



SD card cover



M3



M2

\* Differences according to regions.

Display design and accessories may differ from those illustrated above.

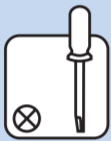

1

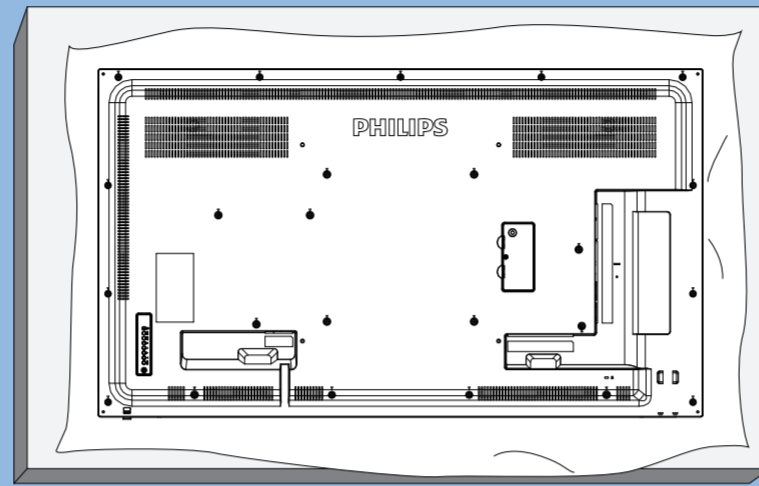

2

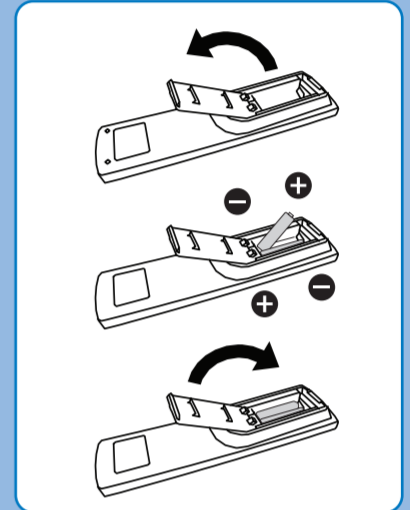
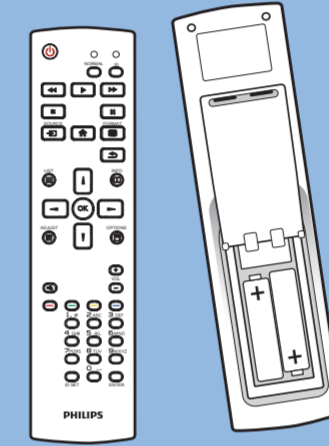
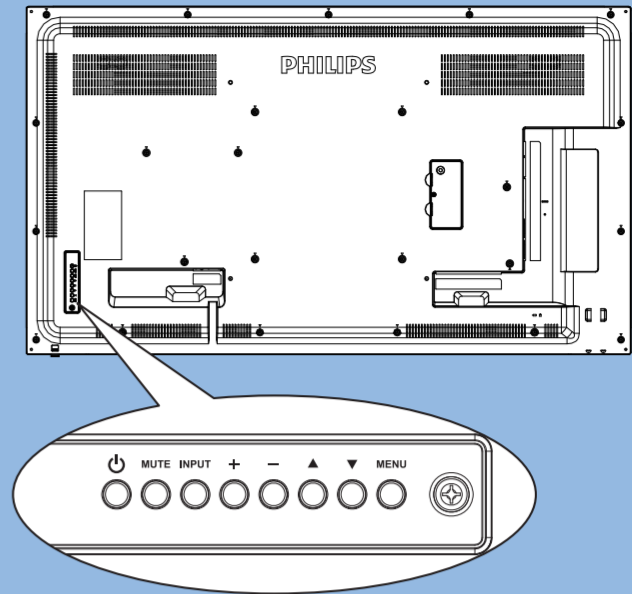

3

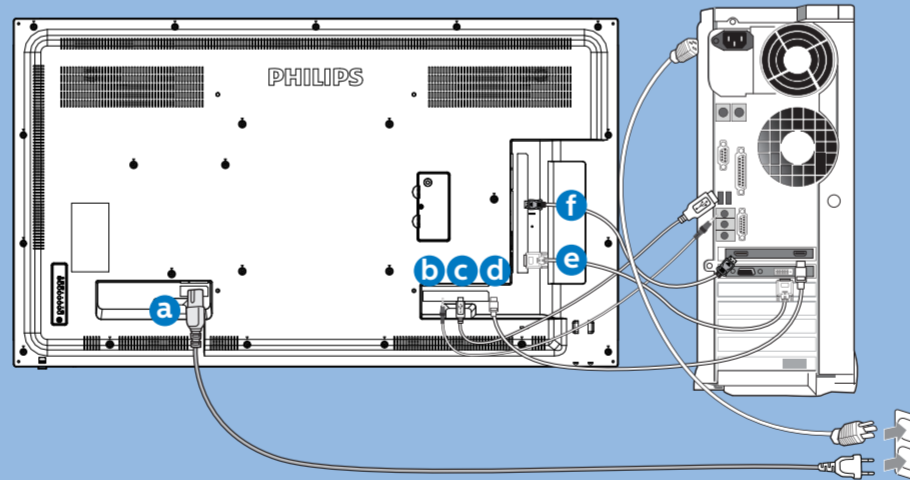
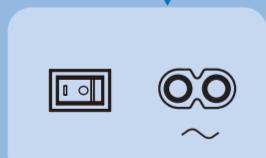
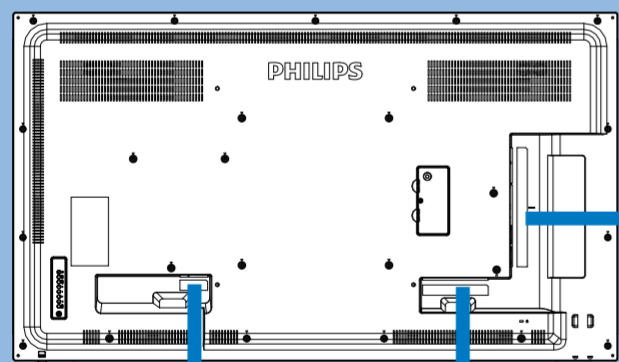

AC IN



AUDIO



Touch USB



HDMI



DVI



DP

4

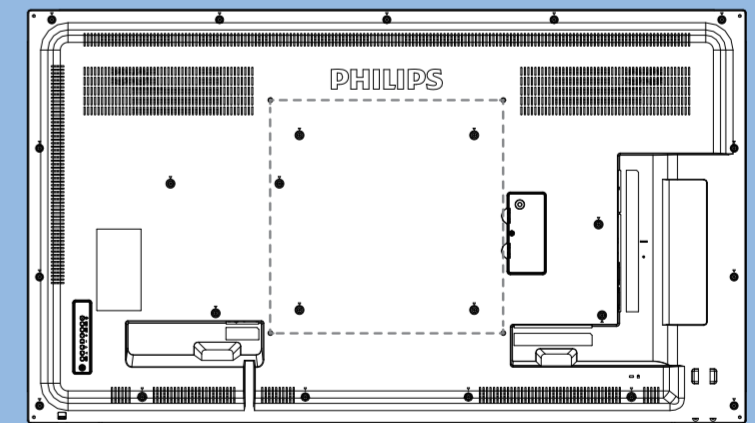

M6 \* (10+X) mm  
(X=Thickness of Wall mount BKT)

55BDL4051D: 400mmx400mm

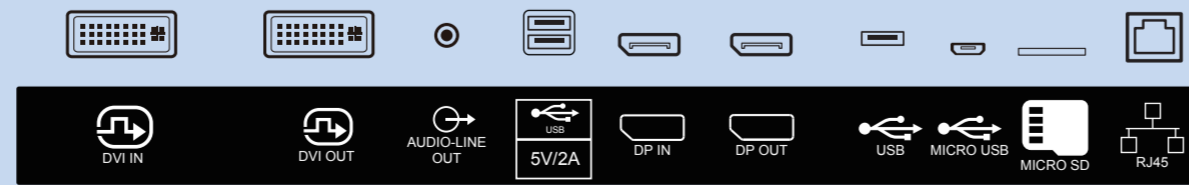
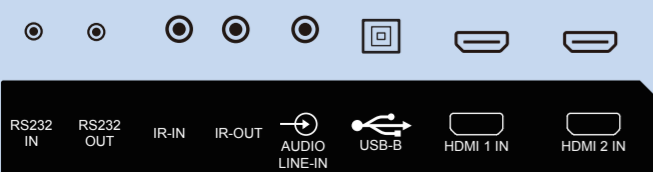

5

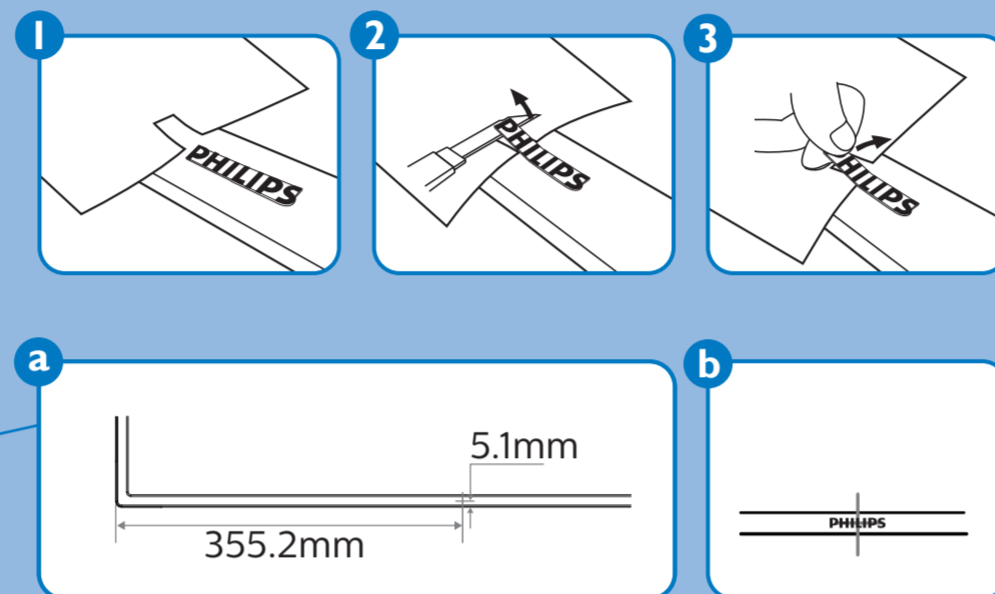
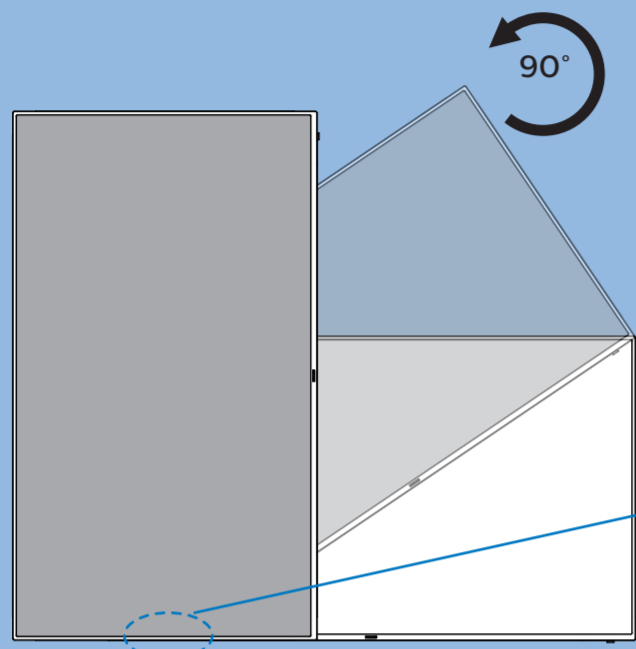

PHILIPS

D line

55BDL4051D



# Quick Start



Please check out the website below for more product information.  
[www.philips.com/signagesolutions-support](http://www.philips.com/signagesolutions-support)



Envision Peripherals Inc.  
 490 N McCarthy Blvd, Suite #120  
 Milpitas, CA 95035  
 USA

© 2019 Koninklijke Philips N.V. All rights reserved.  
 Philips and the Philips Shield Emblem are registered  
 trademarks of Koninklijke Philips N.V. and are used under  
 license from Koninklijke Philips N.V.

Specifications are subject to change without notice.

Version: V1.00 2019-05-23



Q41G55M181350A