



USER GUIDE

LG Digital Signage

(MONITOR SIGNAGE)

Please read this manual carefully before operation and retain it for future reference.

webOS 4.0

CONTENTS

SETTINGS4

- Home.....	4
Global Buttons	
Dashboard	
Content Manager	
- Ez Setting	5
Video Wall	
On/Off Scheduler	
SI Server Setting	
Server Setting	
Fail Over	
Status Mailing	
Play via URL	
Setting Data Cloning	
Sync Mode	
Signage 365 Care	
Multi Screen	
- General.....	11
Language	
System Information	
Set ID	
Time Setting	
Power	
Network	
Safety Mode	
Expert Controls	

- Display	23
Picture Mode	
Aspect Ratio	
Rotation	
Expert Controls	
- Sound.....	28
Sound Mode	
Sound Out	
Audio Out	
AV Sync Adjustment	
Digital Audio Input	
- Admin.....	31
Lock Mode	
Change Password	
Enterprise Settings	
Factory Reset	

CONTENT MANAGER 33

- Web Login.....33
- Content Manager33
 - Player
 - Scheduler
 - Template
- Group Manager 2.040
- ScreenShare.....43

MANAGEMENT TOOLS 44

- Admin.....44
- Picture ID.....45

TOUCH 46

- Touch Assistive Menu.....46
- IDB (Interactive Digital Board).....47

IR CODE 48**CONTROLLING MULTIPLE PRODUCTS..... 50**

- Connecting cables50
- Communication Parameter51
- Command Reference List52
- Transmission/Reception Protocol56

To obtain the source code under GPL, LGPL, MPL, and other open source licenses, that is contained in this product, please visit <http://opensource.lge.com>.

In addition to the source code, all referred license terms, warranty disclaimers and copyright notices are available for download. LG Electronics will also provide open source code to you on CD-ROM for a charge covering the cost of performing such distribution (such as the cost of media, shipping, and handling) upon email request to opensource@lge.com. This offer is valid for a period of three years after our last shipment of this product. This offer is valid to anyone in receipt of this information.



! NOTE

- Software-related content may be changed without prior notice due to upgrades of the product functions.
- Some features described in the User Manual may not be supported in certain models and countries.
- SNMP 2.0 is supported.

SETTINGS

Home

Global Buttons

-  **MOBILE URL:** Provides information necessary to access the monitor set through an external device's browser. With this feature, you can view QR code and URL information. In addition, by accessing the URL, you can also run Content Manager and Group Manager 2.0, and Control Manager. (This feature is optimized for Google Chrome.)
-  **Input:** Navigate to the external input selection screen
-  **Setting:** Navigate to the Settings screen

Dashboard

- This feature displays key information about your Signage monitor in the center of the home screen. In the Dashboard, you can manually change settings by selecting the corresponding items.

! NOTE

- If the dashboard is locked, the focus does not move.

Content Manager

- **Player:** Play a variety of content including images, videos, and SuperSign content.
- **Scheduler:** Manage schedules for content that will be played at different times.
- **Template:** You can create your own content using templates and media files.
- **Group Manager 2.0:** Distribute content schedules and setting data to the connected device.

Ez Setting

Video Wall

SETTINGS / ⚙️ → Ez Setting → Video Wall

Set Video Wall options to create a wide visual canvas.

- **Tile Mode:** Turn **Tile Mode** on or off.
- **Tile Mode Settings:** Display a single integrated screen on multiple Signage monitors.
- **Natural Mode:** Display the image excluding the area that overlaps with the monitor's bezel so that the image displayed has a more natural feel to it.
- **White Balance:** Configure white balance settings (White Pattern, R/G/B-Gain, and Luminance).
- **RESET:** Reset to initial settings.

On/Off Scheduler

SETTINGS / ⚙️ → Ez Setting → On/Off Scheduler

Set a schedule to use your signage by time and day of the week.

- **On/Off Time Setting:** Set on/off times for each day of the week.
- **Holiday Setting:** Set holidays by date and by day of the week.

SI Server Setting

SETTINGS / ⚙️ → Ez Setting → SI Server Setting → SI Server Setting

Set up to connect your signage to an external SI server. Set up a server environment for SI app installation.

SETTINGS / ⚙️ → Ez Setting → SI Server Setting → Developer Mode & Beanviser

This feature provides great convenience to the app developers.

Set up to install and activate the Developer mode and BEANVISER app.

! NOTE

- To use these features, an account (ID/PASSWORD) for webOS Signage developer website (<http://webosignage.developer.lge.com/>) is required.

Server Setting

SETTINGS / ⚙️ → Ez Setting → Server Setting

Set up to connect your signage to a SuperSign server.

- CMS Server
- Control Server

Fail Over

SETTINGS / ⚙️ → Ez Setting → Fail Over

This feature enables automatically switching to other input sources in order of priority if the primary signal is interrupted. It also enables the automatic playback of the content stored on your device.

- **On/Off:** Turns **Fail Over** on or off.
- **Input Priority:** Set the priority of input sources for fail over.
- **Backup via storage:** Automatically play the content stored on the device when there is no input signal. Set to **On** to activate **Auto**, **Manual**, and **SuperSign Contents**.
 - **Auto:** When the automatic input switches due to taking screenshots of an image or video that is playing at regular intervals, this feature will play back the file. (OLED model is not supported.)
 - > **Capture time Interval:** The time interval can be set to 30 min, 1 hour, 2 hours and 3 hours.
 - **Manual:** When the automatic input switches due to the image and video file being uploaded, the feature will play back the file.
 - > **BACKUP MEDIA SELECT:** Using the settings button, you can upload a single file in the internal / external memory.
 - > **Preview:** You can preview the uploaded file.
 - **SuperSign Contents:** When the automatic input switches, this feature will play the file(s) distributed in SuperSign Premium.
- **reset:** Reset to initial settings.

Status Mailing

SETTINGS / ⚙️ → Ez Setting → Status Mailing

This feature configures the system so that the status of the device is assessed and then notified to the administrator by e-mail.

- **On/Off:** Turns **Status Mailing** on or off.
- **Mailing Option, Scheduling:** Sets the email sending interval.
- **User E-mail Address:** Set the user email address of the sender.
- **Sending Server(SMTP):** Set the address of the SMTP server.
- **ID:** Enter the account ID of the sender.
- **Password:** Enter the password for the sender's account.
- **Receiver E-mail Address:** Set the email address of the recipient.
- **SEND MESSAGE:** Immediately assess the status of the device and deliver the information to the specified email address.
- **reset:** Reset to initial settings.

! NOTE

- If the status regarding any of the following items changes or becomes abnormal, a status message can be sent.
 - 1. Temp. Sensor: If the set reaches a dangerous temperature, its current temperature is recorded, and an email containing such information is sent.
 - 2. Temp. Sensor Validation: An email is sent if there is no temperature sensor connected, if the communication status of the temperature sensor is unknown, or if the information provided by the chip provider is abnormal.
 - 3. LAN Status, WiFi Status: An email is sent when the network's connection status is changed. The maximum number of network status changes that can be saved is limited to 50. The saved value is reset once the power turns off.
 - 4. No Signal Check: Checks whether there is a signal. If there are no signals for more than 10 seconds, an email is sent.
 - 5. Schedule Play Status: An email is sent if content cannot be played between the scheduled start time and end time in either Content Management Schedule status or SuperSign Content status. However, this does not apply when terminated using the remote control.
 - 6. Fail Over Status: An email is sent if input switching occurred due to an error. (Excludes input switching initiated by the user (RC, RS232C, SuperSign))
- Only SMTP ports 25, 465, and 587 are supported.
- The occurrence of internal input switches, excluding external input switches (RC, RS232C, SuperSign), are considered as Fail Over Status.
- One email containing the "Failover status : Failover" message is sent when switching to Fail Over Status, and the following status emails sent regularly or upon status changes contain the message "Failover status : None".

Play via URL

SETTINGS / ⚙️ → Ez Setting → Play via URL

Play content you want to play automatically through the built-in web browser.

- **URL Loader:** Turns **Play via URL** on or off.
- **Set URL:** Enter the URL address to display automatically.
- **Preview:** Preview your desired website by accessing the specified URL.
- **Save:** Save the specified URL.
- **Reboot to Apply:** Restarts the monitor set after saving the specified URL.
- **Reset:** Reset to initial settings.

! NOTE

- This feature does not apply when **Screen Rotation** is enabled, and using this feature disables **Preview**.
- If **Time Setting** is not set to **Set Automatically**, website navigation may be difficult.
 - SETTINGS / ⚙️ → CheckGeneral → Time Setting → Set Automatically

Setting Data Cloning

SETTINGS / ⚙️ → Ez Setting → Settings Data Cloning

This feature is used to copy and import the settings of the device to other devices.

- **Export Setting Data:** Export the settings of the device to another device.
- **Import Setting Data:** Import the settings of another device into the device.

Sync Mode

SETTINGS / ⚙️ → Ez Setting → Sync Mode

Sync up time and content among multiple signage.

- **RS-232C Sync:** Sync up multiple signage connected by RS-232C.
- **Network contents sync:** Sync up multiple signage connected to the same network.

Signage 365 Care

SETTINGS / ⚙️ → Ez Setting → Signage 365 Care

You can install the Signage 365 Care (fault diagnosis) solution for fault diagnosis and prediction service.

- **Login/Logout:** Login is required to install and update the Signage 365 Care solution. You will be logged out if there is no connection attempt or the session is expired. The password used for login will be linked to the password for the Admin menu.
- **Install:** Installs the Signage 365 Care solution.
- **Activate/Deactivate:** Activates/deactivates the Signage 365 Care service.
- **Check for Updates:** Checks for available updates in the server.
- **Update:** Updates the Signage 365 Care solution to the latest version.
- **Delete:** Deletes the installed the Signage 365 Care solution.

Multi Screen

SETTINGS / ⚙️ → Ez Setting → Multi Screen

This feature allows you to view multiple external inputs and videos on a single screen.

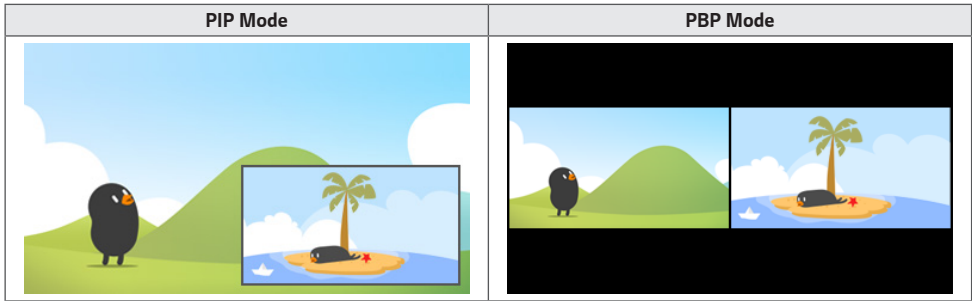

! NOTE

- In multi-screen mode, the DP daisy chain feature is not supported.

Selecting Screen Layout

When you enter multi-screen mode without having set any screen layout, the screen layout selection menu appears. When the screen layout selection menu is not displayed on the screen, go to the screen layout menu bar by pressing the up arrow key on your remote control and select your desired screen layout. If you want to close the screen layout menu, press the back key.

Closing Screen Layout Menu

From the screen layout menu, press the up arrow key on the remote control to go to the screen layout menu bar and select it or press the **back** key to close the screen layout menu.

Changing Screen Input

Press the  button on the top right of each split screen to select the desired input.

! NOTE

- Inputs which have already been selected for other split screens cannot be selected again. To select them, press the RESET button to reset the inputs for all screens first.
- The PIP mode works only when External Input Rotation is set to Off and Screen Rotation is set to Off or 180.
- In the PIP mode, supported resolutions for subscreen are as follows: Other resolutions are not supported.
 - 1680 x 1050 / 1920 x 1080
- Interlaced formats are not supported. E.g. 1080i
- This applies to both AV/Media.

Playing Videos on Split Screens

Press the  button on the upper right of each split screen, select Video File, and then select a storage device to view the list of videos in the selected device. Next, select your desired video from the list to play it.

! NOTE

- Videos created with HEVC, MPEG-2, H.264, or VP9 codecs can be played on split screens. When using PIP mode, the following combinations cannot be used.

Main	Sub
HEVC	HEVC
H.264	HEVC
MPEG2	HEVC
VP9	VP9
H.264 4K	MPEG2
H.264 4K	VP9

General

Language

SETTINGS / ⚙️ → General → Language Settings

You can select the menu language to be displayed on the screen.

- **Menu Language:** Sets the language of your Signage monitor.
- **Keyboard Language:** Sets the language of the keyboard displayed on the screen.

System Information

SETTINGS / ⚙️ → General → System Information

This feature displays information such as the device name, software version, and storage space.

Set ID

SETTINGS / ⚙️ → General → Set ID

- **Set ID (1-1000):** Assigns a unique Set ID number to each product when several products are connected via RS-232C. Assign numbers ranging from 1 to 1000 and exit the option. You can control each product separately by using the Set ID you assigned to each product.
- **Auto Set ID:** Automatically assigns a unique Set ID number to each product when several products are connected for display.
- **Reset Set ID:** Reset the Set ID of the product to 1.

Time Setting

SETTINGS / ⚙️ → General → Time Setting

This feature enables you to view and change the time and date on the device.

- **Set Automatically:** Set **Time** and **Date**.
- **Daylight Saving Time:** Set the start and end times for Daylight Saving Time. The DST start/end times function only when you set them more than one day apart from each other.
- **NTP Server Setting:** Allows you to set other NTP servers other than the basic NTP server.
- **Time Zone:** Allows you to change the time zone based on continent, country/region, city or user settings.

Power

SETTINGS / ⚙️ → General → Power

Power-related feature settings

No Signal Power Off (15 Min)

Set whether to use the 15 Min Auto Off feature.

- You can set this option to **On** or **Off**.
- If you set this feature to **On**, the product turns off when it has remained in No Signal status for 15 minutes.
- If you set this feature to **Off**, the 15 Min Force Off feature is disabled.
- It is recommended that you set this feature to **Off** if you intend to use the product for long periods of time as the feature turns the power of the product off.

No IR Power Off (4hour)

Set whether to use 4 Hours Off feature.

- You can set this option to **On** or **Off**.
- If you set this feature to **On** the product turns off if there is no input from the remote control for 4 hours.
- If you set this feature to **Off**, the 4 Hours Off feature is disabled.
- It is recommended that you set this feature to **Off** if you intend to use the product for long periods of time as the feature turns the power of the product off.

DPM

Set the Display Power Management (DPM) mode.

- If this feature is not set to **Off**, the monitor will enter DPM mode when there is no input signal.
- If you set this feature to **Off**, **DPM** is disabled.

DPM Wake Up Control

Turns on the set according to the digital signal processing of the connected DVI-D/HDMI port.

- When set to **Clock**, the set only checks for digital clock signals and turns on once it finds the clock signal.
- When set to **Clock+DATA**, the set turns on if the digital clock and data signals are both input.

PM Mode

- **Power Off (Default):** Set the normal DC off mode.
- **Sustain Aspect Ratio:** Identical to normal DC off mode except that the Switching IC remains on. On certain models, this applies only to a specific input mode (DisplayPort) and has the same effect as **Screen Off Always** in other input modes.
- **Screen Off:** Switches to **Screen Off** status when entering DPM, Auto Power Off (15 min, 4 hours), or Abnormal Shut Down mode.
- **Screen Off Always:** Switches to **Screen Off** status when entering DPM, Auto Power Off (15 min, 4 hours), Off Time Scheduling, or Abnormal Shut Down mode, or when there is input from the remote control's Power button or the monitor's Off button.
- **Screen Off & Backlight On:** Partially turns on the backlight to keep the display at a proper temperature when in Screen Off status.

NOTE

- In order for the screen to switch from **Screen Off** to On status, there must be input from the remote control's **Power** or **Input** button, or the monitor's **On** button.

Power On Delay(0-250)

- This feature prevents overload by implementing a power-on delay when multiple monitor sets turn on.
- You can set the delay interval in the range of 0 to 250 seconds.

Power On Status

- Select the operating status of the monitor when the main power has turned on.
- You can choose from among **PWR (Power On)**, **STD (Standby)**, and **LST (Last Status)**.
- **PWR (Power On)** keep the monitor powered on when the main power has turned on.
- **STD (Standby)** switch the monitor to Standby status when the main power has turned on.
- **LST (Last Status)** switches the monitor back to its previous status.

Wake On LAN

- Set whether to use **Wake On LAN**.
- You can set the feature to On or Off for each wired/wireless network.
- **Wired:** When set to **On**, the **Wake On LAN** feature is enabled, letting you turn the product on remotely through a wired network.
- **Wireless Network:** When set to **On**, the **Wake On LAN** feature is enabled, letting you turn the product on remotely through a wireless network.

Power Indicator

- This function enables you to change the **Power Indicator** settings.
- Setting to **On** will turn on **Power Indicator**.
- Setting to **Off** will turn off **Power Indicator**.
- Regardless of **On** or **Off** settings in **Power Indicator**, **Power Indicator** will be turned on for approximately 15 seconds.

Power On/Off History

Display the device's power on/off history.

Network

SETTINGS / ⚙️ → General → Network

Wired Connection (Ethernet)

- **Wired Connection:** Connects the monitor to a local area network (LAN) via the LAN port and configures wired network settings. Only wired network connections are supported. After setting up a physical connection, the display will automatically connect without any adjustments on most networks. A small number of networks may require the display settings to be adjusted. For detailed information, contact your Internet provider or consult your router manual.

Wi-Fi Connection

If you have set your monitor up for a wireless network, you can view and connect to available wireless Internet networks.

- **Add a Hidden Wireless Network:** You can add a wireless network by manually typing in its name.
- **Connect via WPS PBC:** Press the button on the wireless router that supports PBC to easily connect to the router.
- **Connect via WPS PIN:** Enter the PIN number in the web page of the PIN-supporting wireless router to connect to the router in a simple manner.
- **Advanced Wi-Fi Settings:** When there is no available wireless network displayed on the screen, you can connect to the wireless network by entering the network information directly.

! NOTE

- When connected to a network that supports IPv6, you can select IPv4 / IPv6 in the wired / wireless network connection. But, IPv6 connection only supports automatic connection.

LAN Daisy Chain

- LAN Daisy Chain forms a daisy chain of LAN ports so that even if you connect only one monitor set to a network, the other sets in the daisy chain are connected to the network.
- However, the first monitor set in the daisy chain must be connected to the network through a port that is not used for the daisy chain connection.

SoftAP

If you set up a SoftAP, you can connect many devices via a Wi-Fi connection without a wireless router and use wireless Internet.

- The SoftAP and ScreenShare features cannot be used at the same time.
- On models that support Wi-Fi dongles, the SoftAP menu is enabled only when a Wi-Fi dongle is connected to the product.
- **Wi-Fi Channel:** You can directly select a Wi-Fi channel.
- SoftAp Access Information
 - SSID: A unique identifier necessary to make a wireless Internet connection
 - Security Key: Security key: The security key you enter to connect to the desired wireless network
 - Connected Devices Count: Number of connected devices: Shows the number of devices currently connected to your Signage device via a Wi-Fi connection. Up to 10 devices are supported.

UPnP

Open and block UDP port 1900, which is used for UPnP.

- The default setting is **On**. Setting this feature to **Off** blocks UDP port 1900, making the UPnP function unavailable.
- If you set this feature to **Off**, Sync Mode's "Network" option will be deactivated. When the value for Sync Mode is "Network," the value switches to "Off," deactivating the "Network" option.
- If you change the UPnP value, the change will not be applied before a **reboot**.
- If you set UPnP to **Off**, you cannot use Group Manager 2.0 properly.

Ping Test

Check your network status with the ping test.

Tips for Network Settings

- Use a standard LAN cable (Cat5 or higher with an RJ45 connector) with this display.
- Many network connection problems during set up can often be fixed by re-setting the router or modem. After connecting the display to the home network, quickly power off and/or disconnect the power cable of the home network router or cable modem, Then power on and/or connect the power cable again.
- Depending on the Internet service provider (ISP), the number of devices that can receive INTERNET service may be limited by the applicable terms of service. For details, contact your ISP.
- LG is not responsible for any malfunction of the display or Internet connection failures due to communication errors/ malfunctions associated with your Internet connection or other connected equipment.
- LG is not responsible for problems within your INTERNET connection.
- You may experience undesired results if the network connection speed does not meet the requirements of the content being accessed.
- Some INTERNET connection operations may not be possible due to certain restrictions set by the Internet service provider (ISP) supplying your Internet connection.
- Any fees charged by an ISP including, without limitation, connection charges are your responsibility.

! NOTE

- If you want to access the Internet directly on your display, the INTERNET connection should always be on.
- If you cannot access the Internet, check the network conditions from a PC on your network.
- When you use Network Setting, check the LAN cable or check if DHCP in the router is turned on.
- If you do not complete the network settings, the network may not function correctly.

! CAUTION

- Do not connect a modular phone cable to the LAN port.
- Since there are various connection methods, please follow the specifications of your telecommunication carrier or INTERNET service provider.
- Network setting menu will not be available until the display connected to physical network.

Tips for When Configuring Wireless Network Settings

- The wireless network may be affected by interference from a device that uses 2.4 GHz frequency, such as a wireless telephone, Bluetooth device or microwave. Interference may also be caused by a device that uses 5 GHz frequency such as Wi-Fi devices.
- The wireless network service may run slowly depending on the surrounding wireless environment.
- Some devices may have a network traffic jam if any local home networks are turned on.
- To connect to a wireless router, a router that supports wireless connection is necessary; the wireless connection function of the corresponding router must also be activated. Ask the router manufacturer whether the router supports wireless connection.
- To connect to a wireless router, verify the SSID and security settings of the wireless router. Please refer to the user guide of the corresponding router regarding SSID and security settings of the wireless router.
- The monitor may not work properly if network devices (wire/wireless router or hub, etc.) are incorrectly set up. Be sure to install the devices correctly by referring to their user guides before configuring the network connection.
- The connection method may vary according to the manufacturer of the wireless router.

Safety Mode

SETTINGS / ⚙️ → General → Safety Mode

Set to this function for safe performance.

ISM Method

If a still image is displayed on the screen for an extended period of time, image sticking can occur. The ISM method is a feature that prevents image sticking.

Mode

- Sets the **ISM Method** mode.
- **Off**: Disable the Brightness Control function.
- **White Wash**: Displays a white pattern to remove image sticking.
- **User Image**: Plays your photos or movies using a USB storage device.
- **User Video**: Plays your photos or movies using a USB storage device.

Repeat Daily

- **Off, Just 1 Time**: Select this mode and click Complete to run the ISM function immediately.
- **On**: Performs the ISM function for the amount of time set in duration if the still image is maintained for the period set in standby.
- **Scheduling**: Performs the ISM function according to settings in date, start time and end time.

StandBy

- You can set the period between 1 and 24 hours.
- This option is available only when **Repeat** is set to **Schedule**.
- The ISM function is performed if the still image is maintained for the set period.

Duration

- You can select from among 1 - 10 min / 20 min / 30 min / 60 min / 90 min / 120 min / 180 min / 240 min.
- This option is available only when **Repeat** is set to **Schedule**.
- The ISM function is performed for the set time.

Select Day

- You can set the date.
- This option is available only when **Repeat** is set to **Schedule**.

Start Time

- Set the Start time.
- This option is available only when **Repeat** is set to **Schedule**.
- You cannot set the same time for Start time and End time.

End Time

- Set the End time.
- This option is available only when **Repeat** is set to **Schedule**.
- You cannot set the same time for Start time and End time.

User Image Download

- In order to download an image, there must be an image file in "ISM" folder on your USB storage device.
- Delete the existing images stored on internal memory before downloading a new image file.
- Supported image file formats: BMP, JPG, JPEG and PNG
- You can download up to 4 images. (The maximum resolution is 1920 x 1080.)
- If a bar image is deleted or does not exist, the default image is used. (The default image is a white background)
- This option is only available when **User Image** is selected.

User Video Download

- In order to download a video, there must be a video file in the "ISM" folder on your USB storage device.
- Delete the existing contents stored on the internal memory before downloading a new video file.
- Supported video file formats: "MP4", "AVI", "FLV", "MKV", "MPEG", "TS"
- You can download only 1 video.
- If a video is deleted or does not exist, the default video is used. (The default video is a white background image)
- This option is only available when **User Image** is selected.

* How to reset or delete User Image / User Video

- Reset using **SETTINGS / ⚙️ > Admin > Factory Reset**
- Open the Player app > Click **Delete** button at the top right of the screen > Delete downloaded image / video

Expert Controls

SETTINGS / ⚙️ → General → Expert Controls

Beacon

- This option enables BLE Beacon, one of Bluetooth 4.0's features.
- Beacon Mode (On/Off Toggle): enables the Beacon feature.
- The LG Beacon/iBeacon/Eddystone Type Beacon features are supported.
- iBeacon
 - Beacon UUID (hex): Set the UUID.
 1. Field1: 4byte hex value (8 digits)
 2. Field2: 2byte hex value (4 digits)
 3. Field3: 2byte hex value (4 digits)
 4. Field4: 2byte hex value (4 digits)
 5. Field5: 6byte hex value (12 digits)
 - Major (0–65535): Sets the Major value.
 - Minor (0–65535): Sets the Minor value.
- Eddystone
 - Frame: Frame: Set UUID or URL.
- 1. Setting the URL method
 - Beacon UUID (hex): Set the UUID.
 - 1 - Field1: 10byte hex value (20 digits)
 - 2 - Field2: 6byte hex value (12 digits)
- 2. Setting the URL method
 - URL Prefix: URL Prefix: Sets the prefix of the URL.
 - URL Suffix: URL Suffix: Set the suffix of the URL.
 - Play via URL URL: Enter the part of the URL that excludes the prefix and suffix.
 - URL string length is limited to 15 characters.
- **Check(OK)** button: The button used to complete and apply the Beacon settings.

NOTE

- Some models do not support background screening services in iOS.
- A reboot is recommended for the settings to be applied properly.
- The UUID value is hexadecimal and the exact number of digits must be entered.
- The distance to Beacon may vary depending on the device.
- The distance to Beacon may vary depending on the application used in the device.
- The Beacon function is affected by radio waves because it employs the Bluetooth Low Energy (BLE) technology. It may not function properly if the frequency range is not around 2.4GHz.

OPS Control

- **OPS Power Control:** This feature enables you to control the power of the OPS as you turn on/off the display.
 - **Disable:** Disable **OPS Power Control**.
 - **Sync (On):** Synchronize the monitor's power status only when the monitor is on.
 - **Sync (On/Off):** Synchronize the monitor's power status with the OPS.
- **Control Interface Selection:** This feature enables you to configure communication with the OPS connected to your monitor.
 - **Display:** Enable communication with external serial ports.
 - **OPS:** Enable communication with the OPS connected to your monitor.

Background Image

This feature enables you to set the default background image.

- **Booting Logo Image:** Change the logo image that appears when the device boots up. If you set this option to Off, no logo image appears when the device boots up. Download or initialize an image file on the storage device.
- **No Signal Image:** Change the image that appears when there is no signal. If you set this option to Off, no image appears when there is no signal. Download or initialize an image file on the storage device.

Input Manager

Specify a label for each input source.

SIMPLINK Setup

- When the **SIMPLINK Setup** is set to **On**, you can use the SIMPLINK provided by LG Signage.
- **Device ID**: Set the ID of the device connected via CEC wiring. You can choose a value between **All** and **E**.
- **Standby**: Sets the scenarios for sending and receiving the OpStandBy (0x0c) command. Detailed scenarios are as follows:

	Transmission	Reception
All	O	O
Send Only	O	X
Receive Only	X	O

Crestron

- This function enables synchronization with applications provided by Crestron.
- **Server**: Server: This menu sets the server's IP address for the network connection with the server (equipment provided by Crestron).
- **Port (1024-65535)**: This menu sets the port for the network connection with the server. The default port number is 41794.
- **IP ID (3-254)**: This menu sets a unique ID for synchronizing with the application.

Display

Picture Mode

SETTINGS / ⚙️ → Display → Picture Mode

Mode

This feature enables you to choose the optimal picture mode for your installation environment.

- **Mall/QSR, Transportation, Education, Gov./Corp.:** Display the picture optimally for your installation environment.
- **Normal:** Display the picture at normal contrast, brightness, and sharpness.
- **APS:** Adjust the screen brightness to reduce power consumption.
- **Expert, Calibration:** Allow an expert, or anyone who loves picture quality, to manually tune to the best picture quality.

! NOTE

- The kinds of **Picture Mode** you can select may vary depending on the input signal.
- **Expert** is an option that allows a picture quality expert to fine-tune the picture quality using a specific image. Thus, it may not be effective for a normal picture.

Customize

- **Backlight, OLED Light:** Adjust the brightness of the screen by adjusting the brightness of the backlight. The closer the value is to 100, the brighter the screen is.
- **Contrast:** Adjust the difference between the light and dark areas of the picture. The closer the value is to 100, the greater the difference is.
- **Brightness:** Adjust the overall brightness of the screen. The closer the value is to 100, the brighter the screen is.
- **Sharpness:** Adjust the sharpness of the edges of objects. The closer the value is to 50, the clearer and the sharper the edge becomes.
- **Color:** Soften or deepen the tints on the screen. The closer the value is to 100, the deeper the colors become.
- **Tint:** Adjust the balance between red and green levels displayed on the screen. The closer to Red 50, the redder the color will be. The closer to Green 50, the greener the color will be.
- **Color Temperature:** The higher you set the color temperature, the cooler the colors on the screen will feel. The lower you set the color temperature, the warmer the colors on the screen will feel.
- **Expert Controls:** Customize the advanced options.
 - **Dynamic Contrast:** Optimize the difference between the light and dark parts of the screen according to the brightness of the image.
 - **Super Resolution:** Sharpen the areas of the screen that are blurry or barely distinguishable.
 - **Color Gamut:** Select the range of colors available.
 - **Dynamic Color:** Adjust the tint and saturation of the image for a more vivid and lively display.
 - **Color Filter:** Accurately adjust color and tint by filtering a specific color area of RGB space.
 - **Preferred Color:** Adjust the skin tint, grass tint, and sky tint to your preference.
 - **Gamma:** Adjust gamma settings to compensate for the brightness of the input signal.
 - **White Balance:** Adjust the overall color fidelity of the screen to your liking. In Expert mode, you can fine-tune the picture using the Method/Pattern options.
 - **Color Management System:** Experts use the color management system when they adjust the colors by using the test pattern. The color management system allows you to make an adjustment by selecting from among 6 different color spaces (Red/Yellow/Blue/Cyan/Magenta/Green) without affecting other colors. In a normal picture, you may not notice the color changes you have made.

- **Picture Option:** Customize the picture options.
 - **Noise Reduction:** Remove randomly popping dots to make the picture look clearer.
 - **MPEG Noise Reduction:** Reduce the noise generated in the process of creating a digital video signal.
 - **Black Level:** Adjust the brightness and contrast of the screen by adjusting the black level of the screen.
(Recommended settings based on input signals: Backlight 0 - 255 High, RGB 16 - 235: Low, YCbCr: Low)
 - **Real Cinema:** Optimize the video image for a cinematic look.
 - **Motion Eye Care:** Reduce eye fatigue by adjusting brightness levels and lessening blurriness based on the displayed image.
 - **Aurora Led Backlight:** Make the light areas of the screen lighter and the dark areas darker for maximum contrast.
Setting this feature to Off may increase the monitor's power consumption.
 - **TruMotion:** Reduce image shaking and image sticking that can occur with moving images. (Some models do not support playback of the content.)
- **APPLY TO ALL INPUTS:** Copies the current value of the detailed setting menu to the entire input, and applies only to the selected picture mode.
- **Initializing:** Reset the picture settings. Because the picture settings are reset according to the monitor's picture mode, please select the picture mode before resetting the picture settings.

Aspect Ratio

SETTINGS / ⚙️ → Display → Aspect Ratio

This feature enables you to change the picture size to view the picture at its optimal resolution.

- **Full Wide:** Stretch the picture to fill the screen.
- **Original:** Display the picture at its original resolution.

Rotation

SETTINGS / ⚙️ → Display → Rotation

Screen Rotation

- This feature rotates the screen clockwise.
- You can set this feature to Off/90/180/270.
- When set to off, this feature is deactivated.
- It is recommended that you use content designed to be used in Portrait mode.

External Input Rotation

- This feature rotates the screen clockwise.
- You can set this feature to Off/90/180/270.
- When this feature is set to On (90 or 270 degrees), as for ARC, the picture is resized to be **Full Wide**.
- If **External Input Rotation** is enabled during WiDi operation, the position of the mouse cursor may not be displayed accurately.
- Please note that the degradation of picture quality that occurs when you have enabled **External Input Rotation** during the use of external input has nothing to do with the product itself.
- When External Input Rotation is set to On, Multi Screen's PIP mode is disabled.
- If External Input Rotation is enabled on models that support touch, touch may not work properly.

Expert Controls

SETTINGS / ⚙️ → Display → Expert Controls

UHD Deep Color

If you connect an HDMI, DP, or OPS device to one of the Deep Color adjustable ports, you can select between UHD Deep Color On (6G) or Off (3G) in the UHD Deep Color settings menu.

If a compatibility issue occurs with a graphics card when the Deep Color option is set to On at 3840 x 2160 @ 60 Hz, set the Deep Color option back to Off.

- HDMI, DP, and OPS specifications may vary depending on the input port. Check the specifications of each device before connecting.
- HDMI input port 2 is best suited for high definition videos that are 4K@60 Hz (4:4:4, 4:2:2). However, video or audio may not be supported depending on the specifications of the external device. If this is the case, please connect the device to a different HDMI port.
- This feature may not be available on some models.

OLED Panel Settings

- **Clear Panel Noise:** Correct issues that may arise when the screen is turned on for a long period of time.

Energy Saving

- **Smart Energy Saving:** Automatically adjust the brightness of the screen according to the brightness of the picture to save energy.
 - **On:** Enable the Smart Energy Saving feature.
 - **Off:** Disable the Smart Energy Saving feature.
- **Brightness Control:** Adjust the brightness of the screen to save energy.
 - **Auto:** Automatically adjust the brightness of the screen according to ambient light.
 - **Off:** Disable energy saving.
 - **Minimum/Medium/Maximum:** Use energy saving according to the energy saving level set for the monitor.
- **Brightness Scheduling:** Adjust the backlight at specified times.
 - You can set this feature to **On/Off**.
 - Add schedule by setting the schedule time and backlight / all red light value.
 - If the current time has not been set, **Brightness Scheduling** is disabled.
 - You can add up to six schedules, and they are sorted in ascending order by time.
 - You can edit a schedule by selecting it from the list and pressing the **OK** button.

HDMI IT Content

Set the HDMI IT Contents function.

- **Off:** Disable the HDMI IT Contents function.
- **On:** Enable the HDMI IT Contents function.

This feature automatically changes the monitor's picture mode based on HDMI Contents information when an HDMI signal is entered.

Even if the monitor's picture mode has been changed by the HDMI IT Contents feature, you can change the picture mode again manually.

As this has a higher priority than the picture mode set by the user, the existing picture mode may be changed when the HDMI signal changes.

Sound

Sound Mode

SETTINGS / ⚙️ → Sound → Sound Mode

Sound Mode

The best sound quality will be selected automatically depending on the video type currently being watched.

- **Standard:** This sound mode works well for content of all types.
- **Cinema:** Optimize sound for watching movies.
- **Clear Voice III:** Enhance voices so they can be heard more clearly.
- **Sports:** Optimize sound for watching sports.
- **Music:** Optimize sound for listening to music.
- **Game:** Optimize sound for playing video games.

Balance

- **Balance:** Adjust the output volume for the left speaker and the right speaker.

Equalizer

- **Equalizer:** Manually adjust sound by using the equalizer.

Initializing

- **Initializing:** Resets sound settings.

Sound Out

SETTINGS / ⚙️ → Sound → Sound Out

- **Internal Speaker / External Speaker:** You can output audio either through your Signage monitor's internal speaker or through an external speaker connected to it.
- **SIMPLINK External Speaker:** This function connects Home Theater device by SIMPLINK. When it is set to Home Theater device input, it outputs voice through the connected device. This option is activated when SIMPLINK has been set to On.
- **LG Sound Sync / Bluetooth:** Enables you to connect Bluetooth audio devices or Bluetooth headsets wirelessly to your monitor so that you can enjoy richer audio conveniently.

! NOTE

- Some recently connected devices may automatically attempt to reconnect to the Signage monitor when it is turned on.
- It is recommended that you set LG audio devices that support LG Sound Sync to LG TV mode or LG Sound Sync mode before connecting.
- Press Device Selection to view the devices that are or that can be connected and connect other devices.
- You can use the signage remote control to adjust the volume of the connected device.
- If the audio device fails to connect, check that it is switched on and available for connection.
- Depending on the type of the Bluetooth device, the device may not connect correctly or an abnormal behavior may occur such as unsynchronized video and audio.
- Sound may stutter or sound quality may be reduced if:
 - The Bluetooth device is too far from the Signage monitor.
 - There is an obstructing object between the Bluetooth device and the Signage monitor.
 - The Bluetooth device is used together with radio equipment such as a microwave oven or wireless LAN.

Audio Out

SETTINGS / ⚙️ → Sound → Audio Out

- **Off:** Disables the use of **Audio Out**. (No audio outputted.)
- **Variable:** You can specify an output range for the external audio device connected to the monitor and adjust the volume within the range. You can change the volume of an external audio device within the range of 0 to 100 (the same as the Signage speaker volume). However, there may be a difference in the actual volume level outputted.
- **Fixed:** Sets a fixed audio output level for the external audio device.
 - If there is no external input, no external audio is outputted.
 - The variable audio output level 100 is the same as the fixed audio output level.

AV Sync Adjustment

SETTINGS / ⚙️ → Sound → AV Sync Adjustment

This feature adjusts audio timing to synchronize video and audio.

- **External Speaker** (0~15): Adjust the sync between video and audio coming from external speakers, such as those connected to the digital audio output port, LG audio equipment, or headphones. Moving closer to - speeds up the audio output, while moving closer to + slows down the audio output, compared to the default value.
- **Internal Speaker** (0~15): Adjust the sync of sound from the internal speakers. Moving closer to - speeds up the audio output, while moving closer to + slows down the audio output, compared to the default value.
- **Bypass:** Output the broadcast signals or the sound from external devices without any audio delay. Audio may be outputted earlier than video due to the processing time for video that is inputted into the monitor.

Digital Audio Input

SETTINGS / ⚙️ → Sound → Digital Audio Input

This feature enables you to choose an input source for audio output.

- **Digital:** Output the audio contained in the digital signal inputted from the connected digital input source (HDMI, DISPLAYPORT, or OPS).
- **Analog:** Output audio from the digital input source (HDMI, DISPLAYPORT, or OPS) connected to the monitor through the Audio In port.

Admin

Lock Mode

SETTINGS / ⚙️ → Admin → Lock Mode

Home Dashboard Lock

This feature enables you to restrict changes made to dashboard lock settings on the Home screen.

USB Lock

This feature enables you to configure the USB lock feature so that settings or content cannot be changed.

OSD Lock

This feature enables you to configure the OSD lock feature so that settings or content cannot be changed.

- Press and hold the Settings key for at least 10 seconds and enter password to access the settings menu in OSD Lock.

IR Operation Lock

- If you set this feature to **Off (Normal)**, you can use your remote control.
- If you set this feature to **On (Power Key Only)**, you can only use the power key.
- If you set this feature to **On (Block All)**, you cannot use your remote control. (However, Power On feature is available.)

Local Key Lock

This feature enables you to configure the Local Key Operation Lock feature so that settings or content cannot be changed.

- If you set this feature to **Off (Normal)**, you can use the local keys on the monitor.
- If you set this feature to **On (Power Key Only)**, you can only use the power key. (When you use a joystick, press and hold a local key to turn on/off the monitor.)
- If you set this feature to **On (Block All)**, you cannot use the local keys. (However, Power On feature is available.)

Wi-Fi Lock

This feature enables you to turn the Wi-Fi feature on or off.

Screen Share Lock

This feature enables you to turn the Screen Share feature on or off.

If the Screen Share Lock value is changed, the function is not applied without a reboot.

Change Password

This feature enables you to set the password you use to enter the Installation menu. (The default password: 000000)

- 1 Enter a new 6-digit password.
- 2 Enter the same password again in the Confirm Password field for confirmation.

Enterprise Settings

- Enter your company account code to apply the corresponding enterprise settings.
- When your code has been entered, the monitor set gets reset, thereby applying the corresponding enterprise settings.
- This feature does not get activated if a code has already been entered.

Factory Reset

Initializes all settings in **Setting** and files from the internal storage.

RGB gain settings in **Calibration**, **Video Wall** of **Ez Setting**, settings in **Server Setting**, and settings in **Set ID** of **General** are exceptions.



NOTE

- It keeps the existing settings because the Off / On button in the User menu only affects the active / inactive status of the submenu.

CONTENT MANAGER

Web Login

- Different features are supported depending on the product. This Signage product comes with a feature that enables you to access it on your PC or mobile device.
- Content Manager, Group Manager 2.0, Control Manager, Log Out, Change Password menus are provided.
- URL: <https://set ip:443>
- The default password: 00000000

CAUTION

- Supported resolutions (this program is optimized for the following resolutions):
 - PC: 1920 x 1080 / 1280 x 1080
 - Mobile: 360 x 640(1440 x 2560, 1080 x 1920), DPR
- Supported browsers (this program is optimized for the following browsers):
 - Chrome 56 or later (recommended)

Content Manager

Player

HOME /  →  (Player)

The Content Manager app's player feature enables you to play/manage contents of video, image, template, SuperSign and playlist in an integrated way. (The OLED models do not support the playback and management of image content and template content.)

Continuous Play

- 1 Select your desired type of content from the tab on the left and then select your desired content.
- 2 Click **Play** in the upper right-hand corner of the screen and enjoy the content you have selected.

Export

- 1 Select your desired type of content from the tab on the left and click **Export** in the upper right-hand corner of the screen.
- 2 Select the content you wish to export.
- 3 Click **Copy/Orbiter** in the upper right-hand corner of the screen and select the device to which you wish to export the content. (If a content file stored on the target device has been selected, the processing of the content file is skipped.)
- 4 You can see that the content has been moved/copied to the device.

DELETE

- 1 Select your desired type of content from the tab on the left and click **DELETE** in the upper right-hand corner of the screen.
- 2 Select the content you wish to delete.
- 3 Click **DELETE** in the upper right-hand corner of the screen.
- 4 You can see that the content has been deleted.

Filter / Sort

- 1 Click **Filter / Sort** in the upper right-hand corner of the screen.
- 2
 - 1) Choose your desired sort criterion to sort content files either by file name or in the order they have been played (the most recently played file shown at the top of the list).
 - 2) It is possible to only view the content stored on your desired device by filtering content files by device.
 - 3) It is possible to only view the content of your desired type by filtering content files by content type.

Create Playlist

When creating a playlist, you cannot include characters that cannot be used in file names on Windows — such as \, /, ;, *, ?, " , <, >, and | — in the names of the files in the playlist. In addition, if the playlist contains content files whose names include such characters, you cannot move or copy the playlist.

- 1 Select the **Playlist** tap from the tab on the left and click **Create Playlist** in the upper right-hand of the screen.
- 2 Select the content you wish to add to the playlist and click **NEXT** in the upper right-hand of the screen.
- 3 Set a play time for each piece of content (applicable only for photo and template content), as well as other items such as Conversion Effect, Ratio, and Auto Playback, and then click **DONE** button in the upper right-hand corner of the screen.
- 4 You can see a new **Playlist** has been created.

DISTRIBUTION

- 1 Click **Distribute** in the upper right-hand corner of the screen.
- 2 Go to the Group Manager app to distribute the created playlists.

Scheduler

HOME /   (Scheduler)

The Content Manager app's scheduler feature enables certain content to be played at a scheduled time through a playlist or external input.

Creating a Schedule

- 1 Click **Add New Schedule** in the upper right-hand corner of the screen.
- 2 Choose between **Playlist** and **Input Source**.
- 3 1) If you have selected **Playlist**, select the playlist you wish to schedule the playback of.
2) If you have selected **Input Source**, select the external input source you wish to schedule the playback of.
- 4 Enter schedule information and create a new schedule. (When creating a schedule, you cannot include characters that cannot be used in file names on Windows — such as \, /, ;, *, ?, " , <, >, and | — in the name of the schedule file. In addition, if the playlist linked to the schedule contains content files whose names include such characters, you cannot move or copy the playlist.)
- 5 Watch the playlist or external input you selected play back at its scheduled time.

Importing a Schedule

- 1 Click **Import** in the upper right-hand corner of the screen.
- 2 Select the external storage device from which you wish to import a schedule.
- 3 Select the schedule you wish to import to your monitor. (You can only choose a single schedule.)
- 4 Click **Select** in the upper right-hand corner of the screen.
- 5 Check that the schedule has been imported to the monitor's internal storage memory.

Exporting a Schedule

- 1 Click **Export** in the upper right-hand corner of the screen.
- 2 Select the external storage device to which you wish to export a schedule.
- 3 Select the schedule you wish to export from your monitor. (You can choose multiple schedules.)
- 4 Click **Select** in the upper right-hand corner of the screen.
- 5 Check that the schedule has been exported to the external storage device you selected.

Delete Schedule

- 1 Click **DELETE** in the upper right-hand corner of the screen.
- 2 Select the schedules you wish to delete.
- 3 Click **DELETE**.
- 4 Check that the schedules have been deleted.

Calendar View

- 1 When you have registered schedules, click **Calendar View**.
- 2 You can see that the schedules registered are displayed in the form of a timetable.

Distribute

- 1 Click **Distribute** in the upper right-hand corner of the screen.
- 2 Go to the Group Manager app to distribute the created schedules.

NOTE

- If the schedule creation time overlaps, the previously created schedule is deleted.
- When a schedule that has not been set repeatedly is completed, the schedule is automatically deleted.
- Schedule does not work while Scheduling list app is running.

Template

HOME /   (Template)

The Content Manager app's editor feature enables you to add your desired templates.

- 1 Select the template of your desired format. (You can choose between Landscape mode and Portrait mode.)
- 2 Modify the template's text.
 - 2-1. Apply your desired font style (Size, Weight, Underline, Italic)
- 3 Modify the media file.
- 4 Save the template by clicking **Save** in the top right-hand corner of the screen.
- 5 Check that the template you saved is shown in the template list.

Supported Photo & Video Files

! NOTE

- Subtitles are not supported.
- The photo feature is not supported in OLED model.

Supported video codecs

Extension	Codec	
.asf, .wmv	Video	VC-1 Advanced Profile (except for WMVA), VC-1 Simple and Main Profiles
	Audio	WMA Standard (excluding WMA v1/WMA Speech)
.avi	Video	Xvid (excluding 3 warp-point GMC), H.264/AVC, Motion Jpeg, MPEG-4
	Audio	MPEG-1 Layer I, II, MPEG-1 Layer III (MP3), Dolby Digital, LPCM, ADPCM, DTS
.mp4, .m4v, .mov	Video	H.264/AVC, MPEG-4, HEVC
	Audio	Dolby Digital, Dolby Digital Plus, AAC, MPEG-1 Layer III (MP3)
.3gp	Video	H.264/AVC, MPEG-4
.3g2	Audio	AAC, AMR-NB, AMR-WB
.mkv	Video	MPEG-2, MPEG-4, H.264/AVC, VP8, VP9, HEVC
	Audio	Dolby Digital, Dolby Digital Plus, AAC, PCM, DTS, MPEG-1 Layer I, II, MPEG-1 Layer III (MP3)
.ts, .trp, .tp, .mts	Video	H.264/AVC, MPEG-2, HEVC
	Audio	MPEG-1 Layer I, II, MPEG-1 Layer III (MP3), Dolby Digital, Dolby Digital Plus, AAC, PCM
.mpg, .mpeg, .dat	Video	MPEG-1, MPEG-2
	Audio	MPEG-1 Layer I, II, MPEG-1 Layer III (MP3)
.vob	Video	MPEG-1, MPEG-2
	Audio	Dolby Digital, MPEG-1 Layer I, II, DVD-LPCM

Supported Photo File Formats

File type	Format	Resolution
.jpeg, .jpg, .jpe	JPEG	<ul style="list-style-type: none"> • Minimum: Min: 64 x 64 • Maximum: Normal Type: 15360 (W) x 8640 (H) Progressive Type: 1920 (W) x 1440 (H)
.png	PNG	<ul style="list-style-type: none"> • Minimum: Min: 64 x 64 • Maximum: 5760 (W) x 5760 (H)
.bmp	BMP	<ul style="list-style-type: none"> • Minimum: Min: 64 x 64 • Maximum: 1920 (W) x 1080 (H)

Tips for using USB storage devices

- Only USB storage devices are recognized.
- USB storage devices connected to the monitor through a USB hub may not work properly.
- USB storage devices that use an automatic recognition program may not be recognized.
- USB storage devices that use their own drivers may not be recognized.
- The recognition speed of a USB storage device may depend on each device.
- Please do not turn off the display or unplug the USB device when the connected USB storage device is working. When the device is suddenly separated or unplugged, the stored files or the USB storage device may be damaged.
- Please do not connect the USB storage device which was artificially maneuvered on the PC. The device may cause the product to malfunction or fail to be played. Remember to only use USB storage devices that store normal music, image, and/or movie files.
- Storage devices formatted with utility programs that are not supported by Windows may not be recognized.
- Please connect power to a USB storage device (over 0.5 A) which requires an external power supply. Otherwise, the device may not be recognized.
- Please connect a USB storage device with the cable offered by the device maker.
- Some USB storage devices may not be supported or operated smoothly.
- File alignment methods of the USB storage device is similar to Windows XP and filenames can include up to 100 English characters.
- Be sure to back up important files since data stored in a USB memory device may be damaged. We will not be responsible for any data loss.
- If the USB HDD does not have an external power source, the USB device may not be detected. So make sure to connect it to an external power source.
 - Please use a power adapter for an external power source. No USB cable is provided for an external power source.

- If your USB storage device has multiple partitions, or if you use a USB multi-card reader, you can use up to four partitions or USB memory devices.
- If a USB storage device is connected to a USB multi-card reader, its volume data may not be detected.
- If the USB storage device does not work properly, remove it and connect it again.
- The speed at which a USB storage device is detected differs from device to device.
- If the USB storage device is connected in Standby Mode, a specific hard disk will automatically be loaded when the display is turned on.
- The recommended capacity is 1 TB or less for a USB external hard disk and 32 GB or less for USB memory.
- Any device with more than the recommended capacity may not work properly.
- If a USB external hard disk with an energy saving feature does not work, turn the hard disk off and on again to make it work properly.
- USB storage devices (USB 2.0 or below) are also supported. However, they may not work properly in the videos list.
- A maximum of 999 folders or files can be recognized under one folder.

Group Manager 2.0

This feature enables you to group together multiple monitor sets on a single network into the same group and to distribute content (schedules and playlists) or copy setting data on a group basis. This feature has two modes, Master and Slave, and it can access the browser on your PC or mobile device.

Master

- Add, edit, and delete group.
- Clone your device's settings data.
- Distribute **Schedule** and **Playlists** on a group basis.
- All monitor sets initially come in Master mode.

Slave

- Play **Schedule** and **Playlists** distributed in Master mode.
- Remove monitor sets for their groups.
- Monitor sets that have been added to a group are automatically switched to Slave mode. Conversely, when a monitor set has been deleted from a group, it is automatically initialized and switched to Master mode.
- If a new Slave has been added to an existing group, or if the **Data Cloning** or the distribution of **schedule/Playlist** has not been properly performed, the **Data Cloning** or **SYNCHRONIZE** button will be activated.
- You can duplicate the master device's setting data to the group by using **Data Cloning**.
- You can re-download the content distributed to the group by using **Synchronize**.

GROUP MANAGEMENT

- Creating a New Group
 1. Click **Add New Group**.
 2. Enter a group name.
 3. Click **Add Device**, select the devices you wish to add to the group, and add them.
 4. Click **Done**, and you will see that a new group has been created.
- Editing a Group
 1. Click the group you wish to edit.
 2. Add a new device by using **Add Device**.
 3. Delete a device by using **Delete Device**.
 4. Check whether the devices in the group are connected to a network by using **Device Check**.
 5. If there are any sets of devices in the group that are not **Data Cloning** or content synchronized, **Data Cloning** or **Synchronize** button will be activated.
 6. You can re-copy the master device's setting data to the group by using **Data Cloning**.
 7. You can re-distribute the content distributed to the group by using **Synchronize**.
- Deleting a Group
 1. Click **Delete Group**.
 2. Select the group you wish to delete and click **Delete**.
 3. Check that the group you selected has been deleted.
- ALL DEVICES VIEW: All Devices View: This page enables you to manage all slave monitor sets that are connected to the same network.
 1. Click **All Devices View**.
 2. Click **Reset Device Mode**.
 3. Select the slave monitor set whose device mode you wish to change and click **Initializing**.

Setting Data Cloning

- 1 Select your desired group and click Clone.
- 2 Check that the data have been copied on the slave sets.

Content Distribute

- 1 Select the type of content you wish to distribute (Schedules or Playlists).
- 2 Select the content you wish to distribute.
- 3 Select the group to which you wish to distribute the content and click **Distribute**.
- 4 Run the Content Manager app on the slave sets and check that the content has been distributed.

How to Use

- Monitor: Run, add, delete or edit app on the home screen.
- Mobile: Mobile devices: Run the app in the Launcher bar or access the app from a mobile device using the QR code or URL provided.



CAUTION

- You can create up to 25 groups.
- You can add up to 12 slave devices to a group.
- You can distribute the schedules stored on external devices after executing Content Manager's import operation.
- Make sure to delete all schedules stored on the slave sets before distributing any schedules.
- A list of devices you can add to your desired group appears only when the following conditions have been met:
 - The devices you wish to add must be on the same network as the master device.
 - The devices you wish to add must be in Master mode, and they must not belong to any existing group.
 - The UPnP feature must be enabled (go to **General** > **Network** > UPnP and set it to **On**).
- It may not work properly in wireless network environments. It is recommended you use a wired network.
- Run the initial settings for Slave function when deleting the group.

ScreenShare

This feature allows the screen of a user's device such as a mobile or PC Windows to be shared with a display using a wireless connection such as WiDi or Miracast.

How to Use ScreenShare

INPUT /  → 

- 1 Connect according to the instructions provided by the guide that can be accessed through the CONNECTION GUIDE button in the upper right.
- 2 Once the connection is established, Screen Share between the user device and the monitor is enabled.

NOTE

Configuring WiDi (Wireless Display)

WiDi, which is short for Wireless Display, is a system that wirelessly transmits video and audio files from a laptop that supports Intel WiDi to the display.

This is available only in certain input modes (Composite/Component/RGB/HDMI/DP/OPS/DVI-D).

Other than these modes, LG Signage cannot be detected by your PC.

- 1 Connect your laptop to AP. (This feature can be used without an AP, but it is recommended that you connect to it for optimal performance.) Go to **PC Settings** → **PC and Devices** → **Devices** on your laptop.
- 2 Click **Add Device** in the top center of the screen, and then you will see a list of nearby WiDi-capable LG Signage monitors. From the list of detected Signage monitors, select one you wish to connect to and click Connect.
- 3 The screen of your laptop screen appears on the screen of the Signage monitor within 10 seconds. The wireless environment may affect the screen from displaying. If the connection is poor, the Intel WiDi connection may be lost.
 - For more information on how to use Intel WiDi, visit <http://intel.com/go/widi>.
 - This feature only works properly with WiDi 3.5 or later versions.
 - This feature only works on Windows 8.1 or later

MANAGEMENT TOOLS

Admin

Control and check the status of the display through the Web browser.

This function is available for PCs and mobile devices.

Different features are supported depending on the product.

Function

- **Dashboard:** Display a summary of the product's status and provides links to each page.
- **Display & sound:** Provides features such as Screen Brightness, Sound, Input, and Reboot.
- **Time Setting:** Enable/disable Set Automatically feature and displays/changes the time set for the product.
- **Network:** Set the name and IP address of your Signage monitor.
- **Tile Mode:** Display the tile mode settings of the product.
- **Fail Over:** Turns the Fail Over feature on or off and sets related items.
- **Play via URL:** Turn Play via URL on or off and set URLs.
- **S/W Update:** Update the firmware of the product.
- **Charts:** Output the product's status information such as its temperature and fan status.
- **Log:** Output product malfunction records.
- **System Information:** Output information such as the product's software version and model name.

Picture ID

Picture ID is used to change the settings of a specific set (display) using a single IR receiver for multi-vision. Communication is possible between a monitor with an IR receiver and other monitors using RS-232C cables. Each monitor is identified by a Set ID. Setting **Picture ID** allows you to only use the remote control with monitors with a **Set ID** that matches the **Picture ID**.

- 1 Assign **Set ID** to the installed monitors as shown below:

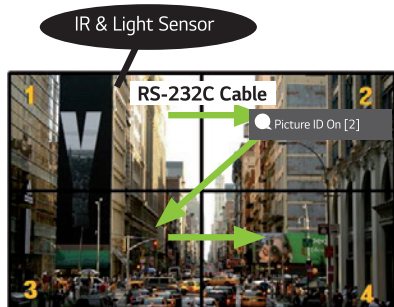

- 2 Press the red **Picture ID On** button on the remote control.
 - 3 Make sure that the Picture ID you set is identical to the **Set ID** of the monitor you wish to control.
- A set with a **Set ID** that is different from the **Picture ID** cannot be controlled by IR signals.

! NOTE

- If **Picture ID** has been set to 2, only the upper right monitor, which has a **Set ID** of 2, can be controlled by IR signals.
- If you press the green **Picture ID Off** button on your remote control, the **Picture ID** for all monitors are turned off. If you then press any button on the remote control, all monitors can be controlled by IR signals regardless of their **Set ID**'s.

TOUCH







Touch Assistive Menu

This touch-exclusive feature allows the user to configure settings without a remote control.

Touching the screen for a certain period of time or pressing the **Touch Assistive Menu** local key brings up the Touch Assistive Menu on the screen.

Different features are supported depending on the product.

Function

-  **Home:** Navigates to the Home screen.
-  **Reader Mode:** A mode with low blue light, which lessens strain on the eyes when reading text.
-  **Local Key:** Configures the product button (local key) lock function.
-  **External Input:** Navigates to the external input selection screen.
-  **Setting:** Navigates to the Settings screen.
-  **IDB:** Run IDB

IDB (Interactive Digital Board)

- This feature may not be available on some models.
- Different features are supported depending on the product.

This feature provides writing function. To run Whiteboard, press the  (IDB) button or the local key Whiteboard button.

Function









- When running Whiteboard, a blank screen appears and you can use Touch to draw.
- When you touch the circle icon in the center of the screen, or keep in contact with any part of the screen for a certain period, the circular menu will expand and appear.
- Press the center of the expanded circle menu to change it to a small icon. You can move the position by dragging the middle part.
- In the circular menu, you can change the pen type and color, and you can erase, revert, and select regions.
- Touch the left or right arrows on the screen to display the full menu and you can delete all screens or save the current screen as a file in the internal storage or external storage.
- You can turn Multi-touch On and Off in the full menu setting. When the Multi-touch function is turned on, the Zoom button appears and when the Multi-touch function is off, you can zoom in and out using two fingers.
- Exit IDB with the Exit button in the full menu setting.
- To connect to a network, press the Start button on IDB and run IDB Duo on the PC that is connected to the same router as the touch model. Then, enter the 6-digit token displayed on IDB.
- To display a video connected to a network or external input cable, select the corresponding item in Pair from the full menu.
- If you touch the screen while a connected video is being displayed, the Markup Mode button will appear. Switching to the Markup Mode allows you to capture the full screen to write on it and save it.

! NOTE

- Files saved in IDB's internal storage are deleted when you quit IDB.
- Whiteboard doesn't enable keys to function except Volume and Power keys.
- When Screen touch is set to Off, Whiteboard is unavailable.
- Whiteboard is unavailable if Screen Rotation is being set.
- Using multiple Touch pens and fingers at the same time, or using Eraser may slow down your work.

IR CODE

- All models do not support the HDMI/USB function.
- Some key codes may not be supported depending on the model.

Code (Hex)	Function	Remarks
08	 (Power)	Remote control button
C4	MONITOR ON	Remote control button
C5	MONITOR OFF	Remote control button
95	 (Energy Saving)	Remote control button
0B	INPUT (Select input)	Remote control button
10	Number Key 0	Remote control button
11	Number Key 1	Remote control button
12	Number Key 2	Remote control button
13	Number Key 3	Remote control button
14	Number Key 4	Remote control button
15	Number Key 5	Remote control button
16	Number Key 6	Remote control button
17	Number Key 7	Remote control button
18	Number Key 8	Remote control button
19	Number Key 9	Remote control button
02	 (Vol +)	Remote control button
03	 (Vol -)	Remote control button
E0	Brightness  (Page Up)	Remote control button
E1	Brightness  (Page Down)	Remote control button
DC	 (3D)	Remote control button
32	1/a/A	Remote control button
2F	CLEAR	Remote control button
7E	 SIMPLINK	Remote control button
79	ARC (Mark/Aspect Ratio)	Remote control button
4D	PSM (Picture Mode)	Remote control button
09	 (MUTE)	Remote control button

Code (Hex)	Function	Remarks
43	⚙️ (Settings/Menu)	Remote control button
99	Auto Configuration	Remote control button
40	⤴️ (Up)	Remote control button
41	⤵️ (Down)	Remote control button
06	➤ (Right)	Remote control button
07	➤ (Left)	Remote control button
44	Ⓞ (OK)	Remote control button
28	↩️ (BACK)	Remote control button
7B	Tile	Remote control button
5B	Exit	Remote control button
72	Picture ID On (red)	Remote control button
71	Picture ID Off (green)	Remote control button
63	Yellow	Remote control button
61	Blue	Remote control button
5F	W.Bal	Remote control button
3F	📄 (S.Menu)	Remote control button
7C	🏠 (Home)	Remote control button
97	Swap	Remote control button
96	Mirror	Remote control button

CONTROLLING MULTIPLE PRODUCTS

- This only applies to certain models.

Use this method to connect several products to a single PC. You can control several products at a time by connecting them to a single PC.

In the Option menu, the Set ID must be between 1 and 1000 without being duplicated.

Connecting cables

- Images may differ according to the model.

Connect the RS-232C cable as shown in the picture.

The RS-232C protocol is used for communication between the PC and product. You can turn the product on/off, select an input source and adjust the OSD menu from your PC.

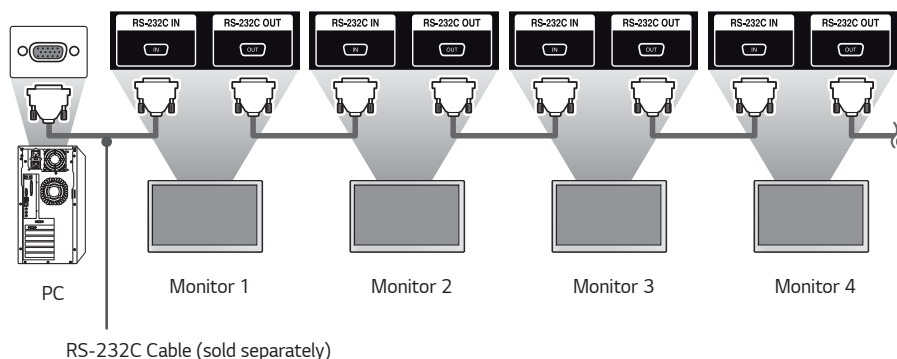
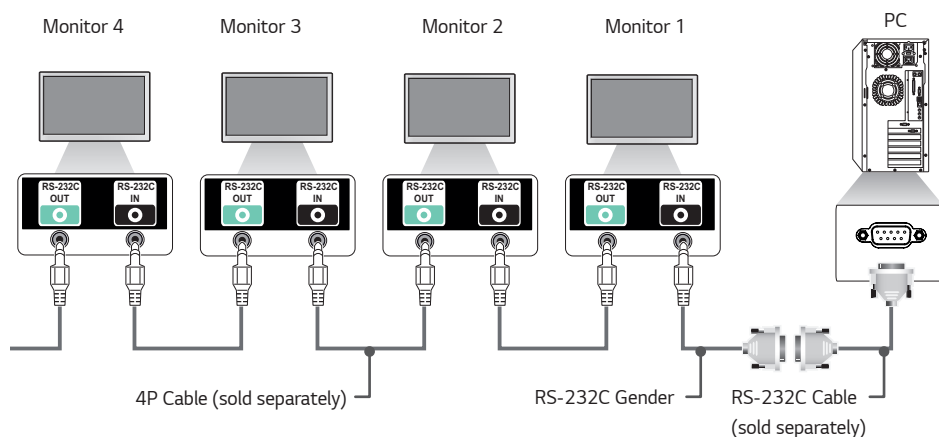

Communication Parameter

Baud Rate: 9600 BPS

Data Length: 8 bits

Parity Bit: None

Stop Bit: 1 bit

Flow Control: None

Communication Code: ASCII

! NOTE

- When using 3-wire connections (non-standard), an IR daisy chain cannot be used.
- Be sure to only use the provided gender to connect properly.
- When you have daisy-chained multiple Signage products to control them simultaneously, if you attempt to turn on/off the master device in a continuous manner, some products may not turn on. In this case, you can turn those monitors on by pressing the **MONITOR ON** button, not the Power button.

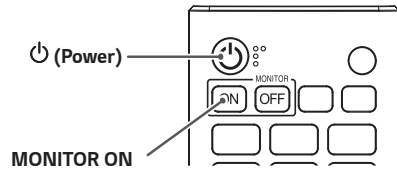

Command Reference List

		Command		Data (Hexadecimal)
		1	2	
01	Power	k	a	00 to 02
02	Select Input	x	b	See Select Input
03	Aspect Ratio	k	c	See Aspect Ratio
04	Brightness Control	j	q	00 to 04
05	Picture Mode	d	x	See Picture Mode
06	Contrast	k	g	00 to 64
07	Brightness	k	h	00 to 64
08	Sharpness	k	k	00 to 32
09	Color	k	i	00 to 64
10	Tint	k	j	00 to 64
11	Color Temperature	x	u	70 to D2
12	Balance	k	t	00 to 64
13	Sound Mode	d	y	See Sound Mode
14	Mute on	k	e	00 to 01
15	Volume Control	k	f	00 to 64
16	Current Time 1 (year/month/day)	f	a	See Current Time 1
17	Current Time 2 (hour/minute/ second)	f	x	See Current Time 2
18	No Signal Power Off (15 Min)	f	g	00 to 01
19	No IR Power Off (4hour)	m	n	00 to 01
20	Language	f	i	See Language
21	Default Settings	f	k	00 - 02
22	Current Temperature	d	n	FF
23	Key	m	c	See Key
24	Time Elapsed	d	l	FF
25	Check product serial number	f	y	FF

		Command		Data (Hexadecimal)
		1	2	
26	Software Version	f	z	FF
27	White Balance Red Gain	j	m	00 to FE
28	White Balance Green Gain	j	n	00 to FE
29	White Balance Blue Gain	j	o	00 to FE
30	White Balance Red Offset	s	x	00 to 7F
31	White Balance Green Offset	s	y	00 to 7F
32	White Balance Blue Offset	s	z	00 to 7F
33	Backlight	m	g	00 to 64
34	Screen Off	k	d	00 to 01
35	Tile Mode	d	d	00 to FF
36	Check Tile Mode	d	z	FF
37	Tile ID	d	i	See Tile ID
38	Natural Mode	d	j	00 to 01
39	DPM	f	j	See DPM
40	Remote Control/Local Key Lock	k	m	00 to 01
41	Power On Delay	f	h	00 to FA
42	Select Fail Over Mode	m	i	00 to 02
43	Select Fail Over Input	m	j	See Select Fail Over Input
44	Remote Control Key Lock	t	p	00 to 02
45	Local Key Lock	t	o	00 to 02
46	Status Check	s	v	See Status Check
47	Daylight Saving Time	s	d	See Daylight Saving Time
48	PM Mode	s	n, 0c	00 to 04
49	ISM Method	j	p	See ISM Method
50	Network Setting	s	n, 80(81)(82)	See Network Setting

		Command		Data (Hexadecimal)
		1	2	
51	Power On Status	t	r	00 to 02
52	Wired Wake On LAN	f	w	00 to 01
53	Screen Rotation	t	h	00 to 03
54	Time Sync	s	n, 16	00 to 01
55	Contents Sync	t	g	00 to 01
56	LAN Daisy Chain	s	n, 84	00 to 01
57	External Input Rotation	s	n, 85	00 to 03
58	Beacon	s	n, 88	00 to 01
59	Brightness Scheduling Mode	s	m	00 to 01
60	Brightness Scheduling	s	s	See Brightness Scheduling
61	Multi Screen Mode & Input	x	c	See Multi-screen Mode & Input
62	See Aspect Ratio	x	d	See Aspect Ratio
63	Screen Off (Multi screen)	x	e	See SCREEN OFF (Multi screen)
64	Screen Off Always	s	n, 0d	00 to 01
65	Stop Video	k	x	00 to 01
66	Wireless Wake On LAN	s	n, 90	00 to 01
67	OSD Lock	k	l	00 to 01
68	HDMI IT Content	s	n, 99	00 to 01
69	Holiday Setting	s	n, 9b	See Holiday Setting
70	UPnP	s	n, 9c	00 to 01
71	Home Dashboard Lock	s	n, 9d	00 to 01
72	USB Lock	s	n, 9e	00 to 01
73	Wi-Fi Lock	s	n, 9f	00 to 01
74	Screen Share Lock	s	n, a0	00 to 01
75	Backup via Storage	s	n, a1	See Backup via Storage

		Command		Data (Hexadecimal)
		1	2	
76	Digital Audio Input	s	n, a2	00 to 01
77	Booting Logo Image	s	n, a3	00 to 01
78	SoftAP	s	n, a4	00 to 01
79	Natural Size	s	n, a5	00 to 64
80	Play Saved Internal Media	s	n, a8	See Playback of Saved Internal Media
81	No Signal Image	s	n, a9	00 to 01
82	Audio Out	s	n, aa	00 to 02
83	DPM Wake Up Control	s	n, 0b	00 to 01
84	Check Fan Failure	d	w	FF
85	Apply to all inputs	s	n, 52	01
86	Timer Power On	f	d	See Timer Power On
87	Timer Power Off	f	e	See Timer Power Off

* Note Commands may not work when there is no external input used.

* Some commands may not be supported on some models.

Transmission/Reception Protocol

Transmission

[Command1][Command2][][Set ID][][Data][Cr]

- * [Command1]: This command is used to identify between the adjustment setting or the user adjustment modes.
- * [Command2]: This command is used to control the monitor.
- * [Set ID]: Used for selecting a set you want to control. A unique Set ID can be assigned to each set ranging from 1 to 1000 (01H to FFH) under Settings in the OSD menu. Selecting '00H' for Set ID allows the simultaneous control of all connected monitors. (The maximum value may differ depending on the model.)
- * [Data]: Transmits command data. Data count may increase depending on the command.
- * [Cr]: Carriage Return. This parameter corresponds to '0 x 0D' in ASCII code.
- * []: White Space. This parameter corresponds to '0 x 20' in ASCII code.

Acknowledgment

[Command2][][Set ID][][OK/NG][Data][x]

- * The product transmits an ACK (acknowledgment) based on this format when receiving normal data. At this point, if the data is FF, it indicates the present status data. If the data is in data write mode, it returns the data of the PC computer.
- * If a command is sent with Set ID '00' (=0 x 00), the data is reflected to all monitors and they do not send an acknowledgment (ACK).
- * If you send "FF" as the value of the data in control mode via RS-232C, you can check the value currently set for the relevant feature (not applicable to some features).
- * Some commands may not be supported on some models.

01. Power (Command: k a)

Controls the power on/off status of the monitor.

Transmission

[k][a][][Set ID][][Data][Cr]

Data 00: Off
01: On
02: Restart

Acknowledgment

[a][][Set ID][][OK/NG][Data][x]

- * The Acknowledgment signal is returned properly only when the monitor is fully powered on.
- * There may be a delay between the Transmission and Acknowledgment signals.
- * This feature may not be available for all models.

02. Select Input (Command: x b)

Selects an input signal.

Transmission

[x][b][][Set ID][][Data][Cr]

Data 20: AV
40: COMPONENT
60: RGB
70: DVI-D (PC)
80: DVI-D (DTV)
90: HDMI1 (DTV)
A0: HDMI1 (PC)
91: HDMI2/OPS (DTV)
A1: HDMI2/OPS (PC)
92: OPS/HDMI3/DVI-D (DTV)
A2: OPS/HDMI3/DVI-D (PC)
95: OPS/DVI-D (DTV)
A5: OPS/DVI-D (PC)
96: HDMI3/DVI-D (DTV)
A6: HDMI3/DVI-D (PC)
97: HDMI3/HDMI2/DVI-D (DTV)
A7: HDMI3/HDMI2/DVI-D (PC)
98: OPS (DTV)
A8: OPS (PC)
C0: DISPLAYPORT (DTV)
D0: DISPLAYPORT (PC)
E0: SuperSign webOS Player
E1: Others
E2: Multi Screen

Acknowledgment

[b][][Set ID][][OK/NG][Data][x]

- * Some input signals may not be available for all models.
- * If it is not distributed from SuperSign W, WebOS Player returns NG.

03. Aspect Ratio (Command: k c)

Adjusts the aspect ratio of your monitor.

Transmission

[k][c][][Set ID][][Data][Cr]

Data 02: Full Screen
06: Original

Acknowledgment

[c][][Set ID][][OK/NG][Data][x]

- * The aspect ratio may differ depending on the model's input configuration.

04. Brightness (Command: j q)

Sets the brightness of your monitor.

Transmission

[j][q][][Set ID][][Data][Cr]

Data 00: Off
01: Minimum
02: Medium
03: Maximum
04: Auto

Acknowledgment

[q][][Set ID][][OK/NG][Data][x]

- * This feature may not be available for all models.

05. Picture Mode (Command: d x)

Selects a picture mode.

Transmission

[d][x][][Set ID][][Data][Cr]

Data 00: Mall/QSR
01: General
02: Gov./Corp.
03: Transportation
04: Education
05: Expert1
08: APS
11: Calibration

Acknowledgment

[x][][Set ID][][OK/NG][Data][x]

- * Some picture modes may not be available for all models.

06. Contrast (Command: k g)

Adjusts the screen contrast.

Transmission

[k][g][][Set ID][][Data][Cr]

Data 00-64: Contrast 0-100

Acknowledgment

[g][][Set ID][][OK/NG][Data][x]

07. Brightness (Command: k h)

Adjusts the screen brightness.

Transmission

[k][h][][Set ID][][Data][Cr]

Data 00-64: Brightness 0-100

Acknowledgment

[h][][Set ID][][OK/NG][Data][x]

08. Sharpness (Command: k k)

Adjusts the screen sharpness.

Transmission

[k][k][][Set ID][][Data][Cr]

Data 00-32: Sharpness 0-50

Acknowledgment

[k][][Set ID][][OK/NG][Data][x]

09. Color (Command: k i)

Adjusts the screen colors.

Transmission

[k][i][][Set ID][][Data][Cr]

Data 00-64: Color 0-100

Acknowledgment

[i][][Set ID][][OK/NG][Data][x]

10. Tint (Command: k j)

Adjusts the screen tints.

Transmission

[k][j][][Set ID][][Data][Cr]

Data 00-64: Tint Red 50-Green 50

Acknowledgment

[j][][Set ID][][OK/NG][Data][x]

11. Color Temperature (Command: x u)

Adjusts the screen color temperature.

Transmission

[x][u][][Set ID][][Data][Cr]

Data 70-D2: 3200K-13000K

Acknowledgment

[u][][Set ID][][OK/NG][Data][x]

12. Balance (Command: k t)

Adjusts the sound balance.

Transmission

[k][t][][Set ID][][Data][Cr]

Data 00-64: Left 50-Right 50

Acknowledgment

[t][][Set ID][][OK/NG][Data][x]

* This feature may not be available for all models.

13. Sound Mode (Command: d y)

Selects a sound mode.

Transmission

[d][y][][Set ID][][Data][Cr]

Data 01: Standard

02: Music

03: Cinema

04: Sports

05: Game

07: News (Clear Voice III)

Acknowledgment

[y][][Set ID][][OK/NG][Data][x]

* This feature may not be available for all models.

14. Mute on (Command: k e)

Mutes/unmutes audio.

Transmission

[k][e][][Set ID][][Data][Cr]

Data 00: Mute (Volume off)

01: Mute off (Volume on)

Acknowledgment

[e][][Set ID][][OK/NG][Data][x]

* This feature may not be available for all models.

15. Volume Control (Command: k f)

Adjusts the playback volume.

Transmission

[k][f][][Set ID][][Data][Cr]

Data 00-64: Volume 0-100

Acknowledgment

[f][][Set ID][][OK/NG][Data][x]

* This feature may not be available for all models.

16. Current Time 1 (year/month/day) (Command: f a)

Sets the Clock 1 (year/month/day) values and Auto Time.

Transmission

1. [f][a][][Set ID][][Data1][][Data2][][Data3][Cr]

2. [f][a][][Set ID][][0][0][][Data1][Cr]

1. When setting Clock 1 (year/month/day)

Data 1 00-: 2010 -

Data 2 01-0C: January - December

Data 3 01-1F: 1-31

* The minimum and maximum values for Data1 differ depending on the product's release year.

* Enter "fa [Set ID] ff" to view Clock 1 (year/month/day) settings.

2. When Setting Auto Time

Data 1 00: Auto

01: Manual

* To view the set value of the Auto time, enter "fa [Set ID] 00 ff".

Acknowledgment

1. [a][][Set ID][][OK/NG][Data1][Data2][Data3][x]

2. [a][][Set ID][][OK/NG][0][0][Data1][x]

17. Current Time 2 (hour/minute/second) (Command: f x)

Sets the Clock 2 values (hour/minute/second).

Transmission

[f][x][][Set ID][][Data1][][Data2][][Data3][Cr]

Data 1 00-17: 00-23 hours

Data 2 00-3B: 00 - 59 minutes

Data 3 00-3B: 00-59 seconds

* Enter "fx [Set ID] ff" to view the Time 2 (hour/minute/second) settings.

* This feature is only available when Clock 1 (year/month/day) has been set.

Acknowledgment

[x][][Set ID][][OK/NG][Data1][Data2][Data3][x]

18. No Signal Power Off(15Min) (Command: f g)

Sets the monitor to enter Automatic Standby mode if there is no signal for 15 minutes.

Transmission

[f][g][][Set ID][][Data][Cr]

Data 00: Off

01: On

Acknowledgment

[g][][Set ID][][OK/NG][Data][x]

19. No IR Power Off (Command: m n)

Activates Auto Power Off when there is no IR signal for 4 hours.

Transmission

[m][n][][Set ID][][Data][Cr]

Data 00: Off

01: On

Acknowledgment

[n][][Set ID][][OK/NG][Data][x]

20. Language (Command: f i)

Sets the OSD language.

Transmission

[f][i][][Set ID][][Data][Cr]

Data 00: Czech

01: Danish

02: German

03: English

04: Spanish (Europe)

05: Greek

06: French

07: Italian

08: Dutch

09: Norwegian

0A: Portuguese

0B: Portuguese (Brazil)

0C: Russian

0D: Finnish

0E: Swedish

0F: Korean

10: Chinese (Mandarin)

11: Japanese

12: Chinese (Cantonese)

13: Arabic

Acknowledgment

[i][][Set ID][][OK/NG][Data][x]

* Some languages may not be available for all models.

21. Default Settings (Command: f k)

Executes Reset.

(Initialize Screen can only be executed in RGB input mode.)

Transmission

[f][k][][Set ID][][Data][Cr]

Data 00: Picture Reset

02: Reset to Initial Settings

Acknowledgment

[k][][Set ID][][OK/NG][Data][x]

* This feature may not be available for all models.

22. Current Temperature (Command: d n)

Checks the current temperature of the product.

Transmission

[d][n][][Set ID][][Data][Cr]

Data FF: Status Check

Acknowledgment

[n][][Set ID][][OK/NG][Data][x]

* The temperature is displayed in hexadecimal.

23. Key (Command: m c)

Sends a key code for the IR remote control.

Transmission

[m][c][][Set ID][][Data][Cr]

Data IR_KEY_CODE

Acknowledgment

[c][][Set ID][][OK/NG][Data][x]

* For key codes, see IR Codes.

* Some key codes may not be supported depending on the model.

24. Time Elapsed (Command: d l)

Displays the time that has elapsed after your monitor has turned on.

Transmission

```
[d][l][ ][Set ID][ ][Data][Cr]
```

Data FF: Read status

Acknowledgment

```
[l][ ][Set ID][ ][OK/NG][Data][x]
```

* The data received is displayed in hexadecimal.

25. Product Serial Number Check (Command: f y)

Checks the serial number of the product.

Transmission

```
[f][y][ ][Set ID][ ][Data][Cr]
```

Data FF: Check product serial number

Acknowledgment

```
[y][ ][Set ID][ ][OK/NG][Data][x]
```

* Data is in ASCII format.

26. Software Version (Command: f z)

Checks the software version of the product.

Transmission

```
[f][z][ ][Set ID][ ][Data][Cr]
```

Data FF: Check the software version

Acknowledgment

```
[z][ ][Set ID][ ][OK/NG][Data][x]
```

27. White Balance Red Gain (Command: j m)

Adjusts the red gain value for white balance.

Transmission

```
[j][m][ ][Set ID][ ][Data][Cr]
```

Data 00-FE: Red Gain 0-254

FF: Checks red gain value

Acknowledgment

```
[m][ ][Set ID][ ][OK/NG][Data][x]
```

28. White Balance Green Gain (Command: j n)

Adjusts the green gain value for white balance.

Transmission

```
[j][n][ ][Set ID][ ][Data][Cr]
```

Data 00-FE: Green Gain 0-254

FF: Checks green gain value

Acknowledgment

```
[n][ ][Set ID][ ][OK/NG][Data][x]
```

29. White Balance Blue Gain (Command: j o)

Adjusts the blue gain value for white balance.

Transmission

```
[j][o][ ][Set ID][ ][Data][Cr]
```

Data 00-FE: Blue Gain 0-254

FF: Checks blue gain value

Acknowledgment

```
[o][ ][Set ID][ ][OK/NG][Data][x]
```

30. White Balance Red Offset (Command: s x)

Adjusts the red offset value for white balance.

Transmission

[s][x][][Set ID][][Data][Cr]

Data 00-7F: Red Offset 0-127
FF: Checks red offset value

Acknowledgment

[x][][Set ID][][OK/NG][Data][x]

31. White Balance Green Offset (Command: s y)

Adjusts the green offset value for white balance.

Transmission

[s][y][][Set ID][][Data][Cr]

Data 00-7F: Green Offset 0-127
FF: Checks green offset value

Acknowledgment

[y][][Set ID][][OK/NG][Data][x]

32. White Balance Blue Offset (Command: s z)

Adjusts the blue offset value for white balance.

Transmission

[s][z][][Set ID][][Data][Cr]

Data 00-7F: Blue Offset 0-127
FF: Checks blue offset value

Acknowledgment

[z][][Set ID][][OK/NG][Data][x]

33. Backlight (Command: m g)

Adjusts the backlight brightness.

Transmission

[m][g][][Set ID][][Data][Cr]

Data 00-64: Backlight 0-100

Acknowledgment

[g][][Set ID][][OK/NG][Data][x]

34. SCREEN OFF (Command: k d)

Turns off/off the screen.

Transmission

[k][d][][Set ID][][Data][Cr]

Data 00: Screen On
01: Screen Off

Acknowledgment

[d][][Set ID][][OK/NG][Data][x]

* This feature may not be available for all models.

35. Tile Mode (Command: d d)

Sets a tile mode and values for the tile rows and columns.

Transmission

[d][d][][Set ID][][Data][Cr]

Data 00-FF: The first byte - tile column
The second byte - tile row

* 00, 01, 10, and 11 mean that the tile mode is off.

* The maximum value may differ depending on the model.

Acknowledgment

[d][][Set ID][][OK/NG][Data][x]

* This feature may not be available for all models.

36. Tile Mode Check (Command: d z)

Checks the tile mode.

Transmission

[d][z][][Set ID][][Data][Cr]

Data FF: Check Tile Mode

Acknowledgment

[z][][Set ID][][OK/NG][Data1][Data2][Data3][x]

Data 1 00: Tile Mode off
01: Tile Mode on

Data 2 00-0F: Tile column

Data 3 00-0F: Tile row

* This feature may not be available for all models.

39. DPM (Command: f j)

Sets the DPM(Display Power Management) function.

Transmission

[f][j][][Set ID][][Data][Cr]

Data 00: Off

04: 1 minute

05: 3 minutes

06: 5 minutes

07: 10 minutes

Acknowledgment

[j][][Set ID][][OK/NG][Data][x]

* This feature may not be available for all models.

37. Tile ID (Command: d i)

Sets the tile ID value of the product.

Transmission

[d][i][][Set ID][][Data][Cr]

Data 01-E1: Tile ID 1-225
FF: Checks the Tile ID

* The data value cannot exceed the value of row x column.

Acknowledgment

[i][][Set ID][][OK/NG][Data][x]

* If you enter a value that exceeds the value of row x column for the Data parameter (except for 0xFF), Ack becomes NG.

* This feature may not be available for all models.

40. Remote Control/Local Key Operation Lock (Command: k m)

Adjusts the remote control/local key (front) lock.

Transmission

[k][m][][Set ID][][Data][Cr]

Data 00: Off (Lock Off)

01: On (Lock On)

* When the monitor is turned off, the power key works even in On (01) mode.

Acknowledgment

[m][][Set ID][][OK/NG][Data][x]

* This feature may not be available for all models.

38. Natural Mode (In Tile Mode) (Command: d j)

To display the image naturally, the part of the image that would normally be displayed in the gap between the monitors is omitted.

Transmission

[d][j][][Set ID][][Data][Cr]

Data 00: Off
01: On

Acknowledgment

[j][][Set ID][][OK/NG][Data][x]

* This feature may not be available for all models.

41. Power On Delay (Command: f h)

Sets the schedule delay for when the power turns on. (Unit: seconds)

Transmission

[f][h][][Set ID][][Data][Cr]

Data 00-FA: Min 0- Max 250 (sec)

Acknowledgment

[h][][Set ID][][OK/NG][Data][x]

* The maximum value may differ depending on the model.

42. Fail Over Mode (Command: m i)

Selects a sound mode.

Transmission

[m][i][][Set ID][][Data][Cr]

Data 00: Off
01: Auto
02: User Setting

Acknowledgment

[i][][Set ID][][OK/NG][Data][x]

43. Fail Over Input Select (Command: m j)

Selects an input source for fail over. (This feature is only available when Fail Over is set to Custom.)

Transmission

[m][j][][Set ID][][Data1][][Data2][][Data3][][Data4]

... [][DataN][Cr]

Data 1-N (Input priority 1-N)
60: RGB
70: DVI-D
90: HDMI1
91: HDMI2
92: OPS/HDMI3/DVI-D
95: OPS/DVI-D
96: HDMI3/DVI-D
97: HDMI3/HDMI2/DVI-D
98: OPS
C0: DISPLAYPORT

Acknowledgment

[j][][Set ID][][OK/NG][Data1][Data2][Data3][Data4]

... [DataN][x]

- * Some input signals may not be available for all models.
- * The data number (N) may vary depending on the model. (The data number depends on the number of supported input signals.)
- * This feature operates as the last input, and supports data in DTV format.

44. Remote Control Key Lock (Command: t p)

Configures the settings of the product's remote control key.

Transmission

[t][p][][Set ID][][Data][Cr]

Data 00: Unlocks all keys
01: Locks all keys except Power key
02: Locks all keys

Acknowledgment

[p][][Set ID][][OK/NG][Data][x]

- * When the monitor is turned off, the power key works even in the locks on all of the keys (02) mode.

45. Local Key Operation Lock (Command: t o)

Configures the local key operation settings of the product.

Transmission

[t][o][][Set ID][][Data][Cr]

Data 00: Unlocks all keys
01: Locks all keys except Power key
02: Locks all keys

Acknowledgment

[o][][Set ID][][OK/NG][Data][x]

- * When the monitor is turned off, the power key works even in the locks on all of the keys (02) mode.
- * This feature may not be available for all models.

46. Status Check (Command: s v)

Checks the current signal of the product.

Transmission

[s][v][][Set ID][][Data][][FF][Cr]

- Data 02: Check whether there is a signal
 03: The monitor is currently in PM Mode
 05: Checks whether luminance sensors 1 and 2 are functioning properly.
 06: Luminance sensors currently being used:
 07: Checks whether the Top, Bottom and Main temperature sensors are functioning normally.
 09: Fan Speed

Acknowledgment

[v][][Set ID][][OK/NG][Data][Data1][x]

- Data 02 (when a signal is found)
 Data 1 00: No signal
 01: Signal present
- Data 03 (when the monitor is currently in PM mode)
 Data 1 00: Screen is on
 01: Screen is off
 02: Screen Off Always is activated
 03: Sustain Aspect Ratio is activated
 04: Screen Off & Backlight On is activated
- Data 05 (when checking whether the luminance sensors are functioning properly)
 Data 1 00: Everything is normal
 01: BLU sensor 1 normal, BLU sensor 2 down
 02: BLU sensor 1 down, BLU sensor 2 normal
 03: All sensors down
- Data 06 (when checking which luminance sensor is in use)
 Data 1 00: Luminance sensor 1 is in use.
 01: Luminance sensor 2 is in use.

Data 07 (when checking whether the Top, Bottom and Main temperature sensors are working properly)

- Data 1 01: All temperature sensors are faulty
 02: Top normal, Bottom faulty, Main faulty
 03: Top faulty, Bottom normal, Main faulty
 04: Top normal, Bottom normal, Main faulty
 05: Top faulty, Bottom faulty, Main normal
 06: Top normal, Bottom faulty, Main normal
 07: All temperature sensors are normal

Data 09 (when checking the fan speed)

Acknowledgment

[v][][Set ID][][OK/NG][Data][Data1][Data2][x]

- Data 1 00: Fan speed upper 1 Byte
 Data 2 00: Fan speed bottom 1 Byte
 Fan Speed: Fan speed: 0 to 2008 in hexadecimal and 0 to 8200 in decimal

* This feature may not be available for all models.

47. Daylight Saving Time (Command: s d)

Sets Daylight Savings Time.

Transmission

[s][d][][Set ID][][Data1][][Data2][][Data3][][Data4][][Data5][][Cr]

- Data 1 00: Off (Data 2-5: FF)
 01: Start Time
 02: End Time
- Data 2 01-0C: January - December
 Data 3 01-06: Week 1 - 6
- * The maximum value of [Data 3] may vary depending on the date.
- Data 4 00-06: (Sunday - Saturday)
 Data 5 00-17: 00 - 23 hours

* If you wish to read the start/end times, enter FF for parameters [Data 2] through [Data 5].

(Example 1: sd 01 01 ff ff ff ff - Checks the start time.

Example 2: sd 01 02 ff ff ff ff - Checks the end time.)

* This feature only works when Clock 1 (year/month/day) and Clock 2 (hour/minute/second) have been set.

Acknowledgment

[d][][Set ID][][OK/NG][Data1][Data2][Data3][Data4][Data5][x]

* This feature may not be available for all models.

48. PM Mode (Command: s n, 0c)

Sets the PM mode.

Transmission`[s][n][][Set ID][][Oc][][Data][Cr]`

Data 00: Power Off (Basic)
 01: Sustain Aspect Ratio
 02: Screen Off
 03: Screen Off Always
 04: Screen Off & Backlight On

Acknowledgment`[n][][Set ID][][OK/NG][Oc][Data][x]`

* This feature may not be available for all models.

49. ISM Method (Command: j p)

If you activate the Screen Off Always feature, the monitor enters Screen Off mode regardless of whether or not you have activated PM mode.

Transmission`[j][p][][Set ID][][Data][Cr]`

Data 04: White Wash
 08: Off
 90: User Image
 91: User Video

Acknowledgment`[p][][Set ID][][OK/NG][Data][x]`

* This feature may not be available for all models.

50. Network Setting (Command: s n, 80 or 81 or 82)

Configures network and DNS settings.

Transmission`[s][n][][Set ID][][Data1][][Data2][][Data3][][Data4][][Data5][Cr]`

Data 1 80: Configures/views the temporary IP mode (Auto/Manual), subnet mask, and gateway.
 81: Configures/views the temporary DNS address.
 82: Saves temporary settings and views information about the current network.

* If Data1 is 80,

Data 2 00: Auto
 01: Manual
 FF: Views the temporary IP mode (Auto/Manual), subnet mask, and gateway.

* If Data2 is 01 (Manual),

Data 3 Manual IP address
 Data 4 Subnet mask address
 Data 5 Gateway address

* If Data1 is 81,

Data 2 DNS address
 FF: Displays the temporary DNS address.

* If Data1 is 82,

Data 2 80: Applies the temporary IP mode (Auto/Manual), subnet mask, and gateway.
 81: Applies the temporary DNS address
 FF: Information on the current network (IP, subnet gateway and DNS)

* An example of settings,

1. Auto: sn 01 80 00
 2. Manual: sn 01 80 01 010177223241 255255254000 010177222001(IP:10.177.223.241, subnet: 255.255.254.0, gateway: 10.177.222.1)
 3. Network read: sn 01 80 ff
 4. DNS setting: sn 01 81 156147035018 (DNS: 156.147.35.18)
 5. Applying the settings: sn 01 82 80 (applies the saved IP mode (auto/manual), subnet mask, and gateway), sn 01 82 81 (applies the saved DSN)
- * Each IP address contains 12 decimal digits.

Acknowledgment`[n][][Set ID][][OK/NG][Data1][Data][x]`

* This feature is available only for wired networks.

* This feature may not be available for all models.

51. Power On Status (Command: t r)

Sets the Power On status of the monitor.

Transmission

[t][r][][Set ID][][Data][Cr]

Data 00: LST(Last Status)
 01: STD(Standby)
 02: PWR(Power On)

Acknowledgment

[r][][Set ID][][OK/NG][Data][x]

52. Wired Wake On LAN (Command: f w)

Selects a Wired Wake On LAN option.

Transmission

[f][w][][Set ID][][Data][Cr]

Data 00: Off
 01: On

Acknowledgment

[w][][Set ID][][OK/NG][Data][x]

53. OSD Rotation (Command: t h)

Sets the Screen Rotation feature.

Transmission

[t][h][][Set ID][][Data][Cr]

Data 00: Off
 01: 90 degrees
 02: 270 degrees
 03: 180 degrees

Acknowledgment

[h][][Set ID][][OK/NG][Data][x]

* This feature may not be available for all models.

54. Time Sync (Command: s n, 16)

Sets Time Sync.

Transmission

[s][n][][Set ID][][1][6][][Data][Cr]

Data 00: Off
 01: On

* This feature only works when the monitor is in Master mode.
 * This feature does not work if the current time is not set.

Acknowledgment

[n][][Set ID][][OK/NG][1][6][Data][x]

* This feature may not be available for all models.

55. Contents Sync (Command: t g)

Sets Content Sync.

Transmission

[t][g][][Set ID][][Data][Cr]

Data 00: Off
 01: On

Acknowledgment

[g][][Set ID][][OK/NG][Data][x]

* This feature may not be available for all models.

56. LAN Daisy Chain (Command: s n, 84)

Turns on/off LAN Daisy Chain.

Transmission

[s][n][][Set ID][][8][4][][Data][Cr]

Data 00: Off
 01: On

Acknowledgment

[n][][Set ID][][OK/NG][8][4][Data][x]

* This feature may not be available for all models.

57. External Input Rotation (Command: s n, 85)

Sets the External Input Rotation feature.

Transmission`[s][n][][Set ID][][8][5][][Data][Cr]`

Data 00: Off
 01: 90 degrees
 02: 270 degrees
 03: 180 degrees

Acknowledgment`[n][][Set ID][][OK/NG][8][5][Data][x]`

* This feature may not be available for all models.

58. Beacon (Command: s n, 88)

Turns on/off Beacon.

Transmission`[s][n][][Set ID][][8][8][][Data][Cr]`

Data 00: Off
 01: On

Acknowledgment`[n][][Set ID][][OK/NG][8][8][Data][x]`

* This feature may not be available for all models.

59. Brightness Scheduling Mode (Command: s m)

Selects a Brightness Scheduling mode.

Transmission`[s][m][][Set ID][][Data][Cr]`

Data 00: Off
 01: On

Acknowledgment`[m][][Set ID][][OK/NG][Data][x]`

* This feature does not work if the current time is not set.

* This feature may not be available for all models.

60. Brightness Scheduling (Command: s s)

Sets Brightness Scheduling.

Transmission`[s][s][][Set ID][][Data1][][Data2][][Data3][Cr]`

Data1
 1. f1 to f6 (data reading)
 F1: Reads the 1st Brightness Scheduling's data
 F2: Reads the 2nd Brightness Scheduling's data
 F3: Reads the 3rd Brightness Scheduling's data
 F4: Reads the 4th Brightness Scheduling's data
 F5: Reads the 5th Brightness Scheduling's data
 F6: Reads the 6th Brightness Scheduling's data

2. FF: Reads all stored lists

3. e1 to e6 (Deletes one index), e0 (Deletes all indexes)

E0: Deletes all Brightness Scheduling
 E1: Deletes the 1st Brightness Scheduling
 E2: Deletes the 2nd Brightness Scheduling
 E3: Deletes the 3rd Brightness Scheduling
 E4: Deletes the 4th Brightness Scheduling
 E5: Deletes the 5th Brightness Scheduling
 E6: Deletes the 6th Brightness Scheduling

4. 00-17: 00 - 23 hours

Data2 00-3B: 00 - 59 minutes

Data3 00-64: Backlight 0 - 100

* To read or delete a list of quick brightness controls you have set, [Data2][Data3] must be set to FF.

* If you want to read a complete list of quick brightness controls you have set through FF, do not enter any values in [Data2][Data3].

* If you want to read a complete list of quick brightness controls you have set through FF, NG is acknowledged if there is no stored list.

Example 1: ss 01 f1 ff ff - Reads the 1st index data from the quick brightness control.

Example 2: ss 01 ff - Reads all index data from the quick brightness control.

Example 3: ss 01 e1 ff ff - Deletes the 1st index data from the quick brightness control.

Example 4: ss 01 07 1E 46 - Adds a schedule whose time is 07:30 and whose backlight is 70.

Acknowledgment`[s][][Set ID][][OK/NG][Data1][Data2][Data3][x]`

* This feature may not be available for all models.

61. Multi Screen Mode & Input (Command: x c)

Saves and controls Multi Screen modes and inputs.

Transmission

```
[x][c][ ][Set ID][ ][Data1][ ][Data2][ ][Data3][ ][Data4][ ][Data5][ ][Cr]
```

Data 1 (Sets MultiScreen mode)

- 10: PIP
- 22: PBP2
- 23: PBP3
- 24: PBP4

Data 2 (Sets the Main input of Multi screen)

Data 3 (Sets the Sub1 input of Multi screen)

Data 4 (Sets the Sub2 input of Multi screen)

Data 5 (Sets the Sub3 input of Multi screen)

- 80: DVI-D
- 90: HDMI1
- 91: HDMI2/OPS
- 92: OPS/HDMI3/DVI-D
- 95: OPS/DVI-D
- 96: HDMI3/DVI-D
- 97: HDMI3/HDMI2/DVI-D
- 98: OPS
- CO: DISPLAYPORT

Acknowledgment

```
[c][ ][Set ID][ ][OK/NG][ ][Data1][Data2][Data3][Data4][Data5][x]
```

- * This feature may not be available for all models.
- * Only the input modes supported by the model works.
- * This feature operates as the last input, and supports data in DTV format.

62. Aspect Ratio (Multi screen) (Command: x d)

Controls the aspect ratio of Multi Screen.

Transmission

```
[x][d][ ][Set ID][ ][Data1][ ][Data2][Cr]
```

Data1 01: Controls the Main input
02: Controls the Sub1 input
03: Controls the Sub2 input
04: Controls the Sub3 input

Data2 00: Full Screen
01: Original

Acknowledgment

```
[d][ ][Set ID][ ][OK/NG][Data1][Data2][x]
```

- * This feature may not be available for all models.

63. SCREEN OFF (Multi screen) (Command: x e)

Turns on/off each screen in the Multi Screen.

Transmission

```
[x][e][ ][Set ID][ ][Data1][ ][Data2][Cr]
```

Data 1 01: Controls the Main input
02: Controls the Sub1 input
03: Controls the Sub2 input
04: Controls the Sub3 input

Data 2 00: Screen On
01: Screen Off

- * This feature only works when the Multi Screen app is running.
- * This feature does not work when there is no signal.

Acknowledgment

```
[e][ ][Set ID][ ][OK/NG][Data1][Data2][x]
```

- * This feature may not be available for all models.

64. Screen Off Always (Command: s n, Od)

If you activate the Screen Off Always feature, the monitor enters Screen Off mode regardless of whether or not you have activated PM mode.

Transmission

```
[s][n][ ][Set ID][ ][0][d][ ][Data][Cr]
```

Data 00: Off
01: On

Acknowledgment

```
[n][ ][Set ID][ ][OK/NG][0][d][Data][x]
```

- * This feature may not be available for all models.

65. Stop Video (Command: k x)

Controls Stop Video.

Transmission`[k][x][][Set ID][][Data][Cr]`

Data 00: The Stop Video feature is on.
01: The Stop Video feature is off.

- * This feature only works in single input mode.

Acknowledgment`[x][][Set ID][][OK/NG][Data][x]`

- * This feature may not be available for all models.

66. Wireless Wake On LAN (Command: s n, 90)

Sets the Wireless Wake-on-LAN feature.

Transmission`[s][n][][Set ID][][9][0][][Data][Cr]`

Data 00: Off
01: On

Acknowledgment`[n][][Set ID][][OK/NG][9][0][Data][x]`

- * This feature may not be available for all models.

67. OSD Lock (Command: k l)

Sets OSD Lock.

Transmission`[k][l][][Set ID][][Data][Cr]`

Data 00: OSD Lock
01: Unlock OSD Lock

Acknowledgment`[l][][Set ID][][OK/NG][Data][x]`**68. HDMI IT Content (Command: s n, 99)**

Automatically sets the picture mode based on HDMI data.

Transmission`[s][n][][Set ID][][9][9][][Data][Cr]`

Data 00: Off
01: On

Acknowledgment`[n][][Set ID][][OK/NG][9][9][Data][x]`

- * This feature may not be available for all models.

69. Holiday Setting (Command: s n, 9b)

Sets holidays.

Transmission`1. [s][n][][Set ID][][9][b][][Data1][][Data2][][Data3][][Data4][][Data5][][Data6][Cr]`

2. [s][n][][Set ID][][9][b][][Data1][][Data2][Cr]

3. [s][n][][Set ID][][9][b][][Data1][Cr]

1. Setting a Holiday

Data 1 Start year
00-: 2010-
Data 2 Start month
01 - 0c: January - December
Data 3 Start date
01 - 1F: 01-31
Data 4 For how long from the start year/month/date
01-07: For 1 to 7 days

Data 5 Repetition
00: None
01: Every month
02: Every Year
Data 6 Repeats the schedule on a date/day-of-the-week basis.
01: On a date basis.
02: On a day-of-the-week basis.

- * The minimum and maximum values for Data1 differ depending on the product's release year.
- * You can input a value for [Data 6] only when a value has already been set for [Data 5] (every year or every month).

2. Checking a Schedule

Data 1 Select the desired schedule.
F1: Reads the 1st schedule
F2: Reads the 2nd schedule
F3: Reads the 3rd schedule
F4: Reads the 4th schedule
F5: Reads the 5th schedule
F6: Reads the 6th schedule
F7: Reads the 7th schedule

Data 2
FF

3. Deleting a Schedule

- E0: Deletes all holiday schedules
- E1: Deletes the 1st holiday schedule
- E2: Deletes the 2nd holiday schedule
- E3: Deletes the 3rd holiday schedule
- E4: Deletes the 4th holiday schedule
- E5: Deletes the 5th holiday schedule
- E6: Deletes the 6th holiday schedule
- E7: Deletes the 7th holiday schedule

* This feature does not work if the current time is not set.

Acknowledgment

1. [n][][Set ID][][OK/NG][9][b]
[Data1][Data2][Data3][Data4][Data5][Data6][x]
2. [n][][Set ID][][OK/NG][9][b][f][1~7]
[Data1][Data2][Data3][Data4][Data5][Data6][x]
3. [n][][Set ID][][OK/NG][9][b][Data1][x]

* This feature may not be available for all models.

70. ISM Method (Command: s n, 9c)

Sets UPnP mode.

Transmission

[s][n][][Set ID][][9][c][][Data][Cr]

Data 00: Off

01: On

Acknowledgment

[n][][Set ID][][OK/NG][9][c][Data][x]

* This feature may not be available for all models.

* Changing UPnP mode results in a reboot.

71. Home Dashboard Lock (Command: s n, 9d)

Sets Home Dashboard Lock.

Transmission

[s][n][][Set ID][][9][d][][Data][Cr]

Data 00: Home Dashboard Unlock

01: Home Dashboard Lock

Acknowledgment

[n][][Set ID][][OK/NG][9][d][Data][x]

* This feature may not be available for all models.

72. USB Lock (Command: s n, 9e)

Sets USB Lock.

Transmission

[s][n][][Set ID][][9][e][][Data][Cr]

Data 00: USB Unlock

01: USB Lock

Acknowledgment

[n][][Set ID][][OK/NG][9][e][Data][x]

* This feature may not be available for all models.

73. Wi-Fi Lock (Command: s n, 9f)

Sets Wi-Fi Lock.

Transmission`[s][n][][Set ID][][9][f][][Data][Cr]`Data 00: Wi-Fi Unlock
01: Wi-Fi Lock**Acknowledgment**`[n][][Set ID][][OK/NG][9][f][Data][x]`

* This feature may not be available for all models.

74. Screen Share Lock (Command: s n, a0)

Sets Screen Share Lock.

Transmission`[s][n][][Set ID][][a][0][][Data][Cr]`Data 00: Screen Share Unlock
01: Screen Share Lock**Acknowledgment**`[n][][Set ID][][OK/NG][a][0][Data][x]`

* This feature may not be available for all models.

75. See Backup via Storage (Command: s n, a1)

Sets Backup via Storage.

Transmission1. `[s][n][][Set ID][][a][1][][Data1][Cr]`2. `[s][n][][Set ID][][a][1][][Data1][Data2][Cr]`1. Disabling Backup via Storage.
Data 1 00: Off

2. Setting Backup via Storage to Auto

Data 1 01: Auto
Data 2 01: 30 minute
02: End time
03: End time
04: End time

3. Setting Backup via Storage to Manual

Data 1 02: Manual

4. Setting Backup via Storage to SuperSign Content

Data 1 03: SuperSign Contents

Acknowledgment1. `[n][][Set ID][][OK/NG][a][1][Data1][x]`2. `[n][][Set ID][][OK/NG][a][1][Data1][Data2][x]`

* This feature may not be available for all models.

76. Digital Audio Input (Command: s n, a2)

Sets Digital Audio Input.

Transmission`[s][n][][Set ID][][a][2][][Data][Cr]`

Data 00: Digital

01: Analog

Acknowledgment`[n][][Set ID][][OK/NG][a][2][Data][x]`

* This feature may not be available for all models.

79. Natural Size (Command: s n, a5)

Sets the Natural Size feature.

Transmission`[s][n][][Set ID][][a][5][][Data][Cr]`

Data 00-64: Natural Size 0 - 100

Acknowledgment`[n][][Set ID][][OK/NG][a][5][Data][x]`

* This feature may not be available for all models.

77. Booting Logo Image (Command: s n, a3)

Sets Booting Logo Image.

Transmission`[s][n][][Set ID][][a][3][][Data][Cr]`

Data 00: Off

01: On

Acknowledgment`[n][][Set ID][][OK/NG][a][3][Data][x]`

* This feature may not be available for all models.

80. Play Saved Internal Media (Command: s n, a8)

Plays media files saved on internal storage. Internal storage media: videos and images stored on the monitor's internal storage after being exported via Contents Management Player.

* Not applicable: Template content, SuperSign content, and playlist content.

Transmission`[s][n][][Set ID][][a][8][][Data][Cr]`

Data 01: Play

Acknowledgment`[n][][Set ID][][OK/NG][a][8][][Data][x]`

* This feature may not be available for all models.

78. SoftAP (Command: s n, a4)

Sets SoftAP Mode.

Transmission`[s][n][][Set ID][][a][4][][Data][Cr]`

Data 00: Off

01: On

Acknowledgment`[n][][Set ID][][OK/NG][a][4][Data][x]`

* This feature may not be available for all models.

81. No Signal Image (Command: s n, a9)

Sets the No Signal Image feature.

Transmission`[s][n][][Set ID][][a][9][][Data][Cr]`

Data 00: Off

01: On

Acknowledgment`[n][][Set ID][][OK/NG][a][9][Data][x]`

* This feature may not be available for all models.

82. Audio Out (Command: s n, aa)

Sets Audio Out to Off/Variable/Fixed.

Transmission`[s][n][][Set ID][][a][a][][Data][Cr]`

Data 00: Off
01: Variable
02: Fixed

Acknowledgment`[n][][Set ID][][OK/NG][a][a][Data][x]`

* This feature may not be available for all models.

83. DPM Wake Up Control (Command: s n, 0b)

Controls the DPM Wake Up Control settings.

Transmission`[s][n][][Set ID][][0][b][][Data][Cr]`

Data 00: Clock
01: Clock+DATA

Acknowledgment`[n][][Set ID][][OK/NG][0][b][Data][x]`

* This feature may not be available for all models.

84. Fan Failure Check (Command: d w)

Check the fan malfunction.

Transmission`[d][w][][Set ID][][Data][Cr]`

Data FF: Read status

Acknowledgment`[w][][Set ID][][OK/NG][Data1][Data2][x]`

Data 1 00: Fan failure
01: Fan normal

Data 2 00: 0 faults (Fan Normal)
01: 1 fault
02: 2 faults
03: 3 faults
04: 4 faults
05: 5 faults
06: 6 faults
07: 7 faults
08: 8 faults
09: 9 faults
0A: 10 faults

* This feature may not be available for all models.

85. Apply to all inputs (Command: n, 52)

Apply the video mode and low value of the current input to the same video value of all inputs.

Transmission`[s][n][][Set ID][][5][2][][Data][Cr]`

Data 01: Apply

Acknowledgment`[n][][Set ID][][OK/NG][5][2][Data][x]`

* This feature may not be available for all models.

* Other commands do not work for a certain time after applying.

86. Timer Power On Scheduling (Command: f d)

Sets On Timer settings.

Transmission`[f][d][][Set ID][][Data1][][Data2][][Data3][Cr]`

Data1

1. f1h to f7h (data reading)

F1: Reads the 1st Timer Power On's data
F2: Reads the 2nd Timer Power On's data
F3: Reads the 3rd Timer Power On's data
F4: Reads the 4th Timer Power On's data
F5: Reads the 5th Timer Power On's data
F6: Reads the 6th Timer Power On's data
F7: Reads the 7th Timer Power On's data

2. e1h to e7h (Deletes one index), e0h (Deletes all indexes)

E0: Delete all Timer Power On's

E1: Delete the 1st Timer Power On
E2: Delete the 2nd Timer Power On
E3: Delete the 3rd Timer Power On
E4: Delete the 4th Timer Power On
E5: Delete the 5th Timer Power On
E6: Delete the 6th Timer Power On
E7: Delete the 7th Timer Power On

3. 01h to 0ch (Timer Power On days setting)

02: Repeat Daily

03: Repeat from Monday to Friday

04: Repeat from Monday to Saturday

05: Repeat from Saturday to Sunday

06: Repeat on Sunday

07: Repeat on Monday

08: Repeat on Tuesday

09: Repeat on Wednesday

0A: Repeat on Thursday

0B: Repeat on Friday

0C: Repeat on Saturday

Data2 00-17:00 - 23 hours

Data3 00-3B:00 - 59 minutes

* To read or delete a Timer Power On you have set, [Data2] [Data3] must be set to FFH.

Example 1: fd 01 f1 ff ff - Reads the 1st index data in Timer Power On.

Example 2: fd 01 e1 ff ff - Reads the 1st index data in Timer Power On.

Example 3: fd 01 04 02 03 - Sets the Timer Power On as Monday - Saturday 02:03.

* This feature only works when Clock 1 (year/month/day) and Clock 2 (hour/minute/second) have been set.

Acknowledgment

[d][][Set ID][][OK/NG][Data1][Data2][Data3][x]

87. Time to OFF Scheduling (Command: f e)

Sets Off Timer settings.

Transmission

[f][e][][Set ID][][Data1][][Data2][][Data3][Cr]

Data1

1. f1h to f7h (data reading)

F1: Reads the 1st Timer Power Off's data

F2: Reads the 2nd Timer Power Off's data

F3: Reads the 3rd Timer Power Off's data

F4: Reads the 4th Timer Power Off's data

F5: Reads the 5th Timer Power Off's data

F6: Reads the 6th Timer Power Off's data

F7: Reads the 7th Timer Power Off's data

2. e1h to e7h (Deletes one index), e0h (Deletes all indexes)

E0: Delete all Timer Power Off's

E1: Delete the 1st Timer Power Off

E2: Delete the 2nd Timer Power Off

E3: Delete the 3rd Timer Power Off

E4: Delete the 4th Timer Power Off

E5: Delete the 5th Timer Power Off

E6: Delete the 6th Timer Power Off

E7: Delete the 7th Timer Power Off

3. 01h to 0ch (Timer Power Off days setting)

02: Repeat Daily

03: Repeat from Monday to Friday

04: Repeat from Monday to Saturday

05: Repeat from Saturday to Sunday

06: Repeat on Sunday

07: Repeat on Monday

08: Repeat on Tuesday

09: Repeat on Wednesday

0A: Repeat on Thursday

0B: Repeat on Friday

0C: Repeat on Saturday

Data2 00-17:00 - 23 hours

Data3 00-3B:00 - 59 minutes

* To read or delete a Timer Power Off you have set, [Data2] [Data3] must be set to FFH.

Example 1: fe 01 f1 ff ff - Reads the 1st index data in Timer Power Off.

Example 2: fe 01 e1 ff ff - Reads the 1st index data in Timer Power Off.

Example 3: fe 01 04 02 03 - Sets the Timer Power Off as Monday - Saturday 02:03.

* This feature only works when Clock 1 (year/month/day) and Clock 2 (hour/minute/second) have been set.

Acknowledgment

[e][][Set ID][][OK/NG][Data1][Data2][Data3][x]

