

55SVM5F

55SVH7F

55SVH7F-A

**ENGLISH Installation Guide**

Please read this manual carefully before operating your set and retain it for future reference.

**FRANÇAIS Guide d'installation**

Veuillez lire ce manuel attentivement avant d'utiliser l'appareil et conservez-le pour pouvoir vous y reporter ultérieurement.

**ESPAÑOL Guía de instalación**

Lea atentamente este manual antes de poner en marcha el equipo y consérvelo para futuras consultas.

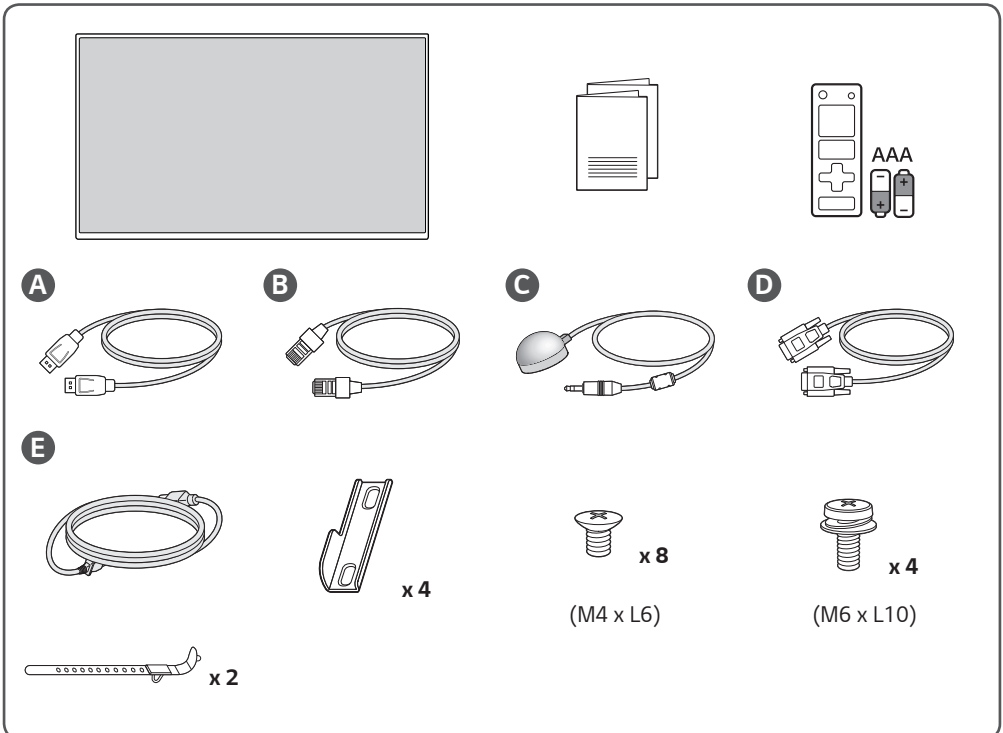



- ▶ [www.lg.com/id-manual](http://www.lg.com/id-manual)
- ▶ SuperSign : <http://partner.lge.com>

**ENGLISH**

You can download more detailed information on our website by searching the model number provided on the cover page.

**FRANÇAIS**

Vous pouvez télécharger des informations plus détaillées sur notre site Web en faisant une recherche à l'aide du numéro de modèle indiqué sur la page de couverture.

**ESPAÑOL**

Busque en nuestro sitio web el número de modelo que aparece en la portada y descargue información más detallada.



### ENGLISH

Dimensions (Width x Height x Depth) / Weight	1,210.51 mm x 681.22 mm x 86.5 mm / 16.8 kg (47.6 inches x 26.8 inches x 3.4 inches / 37 lbs)
---	--

### FRANÇAIS

Dimensions (largeur x hauteur x profondeur) / Poids	1 210,51 mm x 681,22 mm x 86,5 mm / 16,8 kg (47,6 po x 26,8 po x 3,4 po / 37 lb)
--	---

### ESPAÑOL

Dimensiones (ancho x alto x profundidad) / Peso	1 210,51 mm x 681,22 mm x 86,5 mm / 16,8 kg
Alimentación	CA 100-240 V ~ 50/60 Hz, 2,7 A

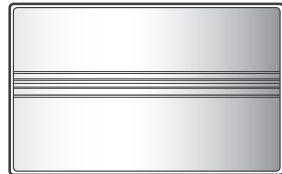
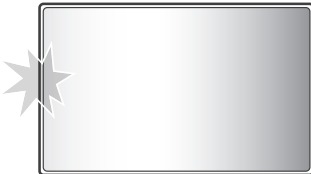
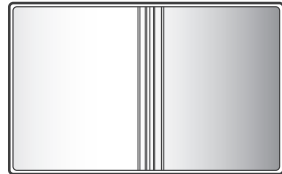
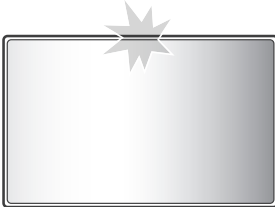
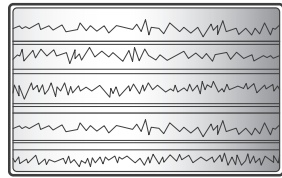
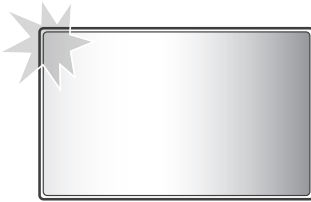
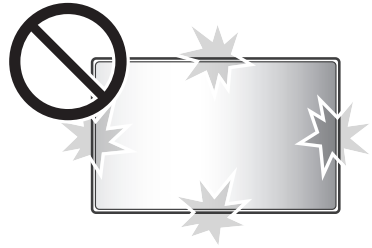
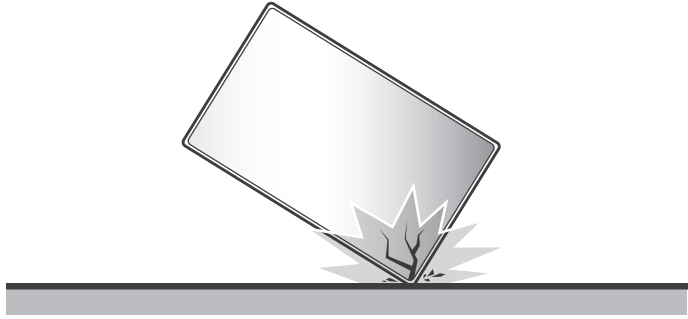

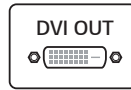
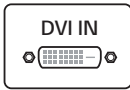
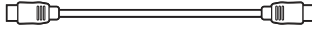

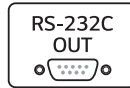
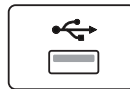
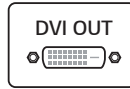
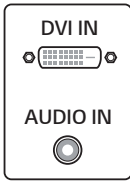

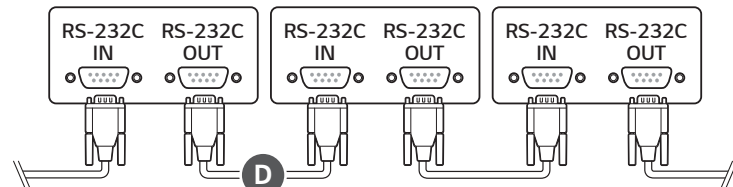
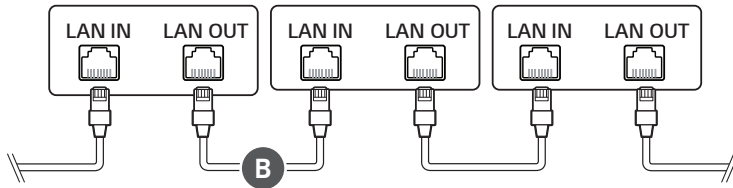
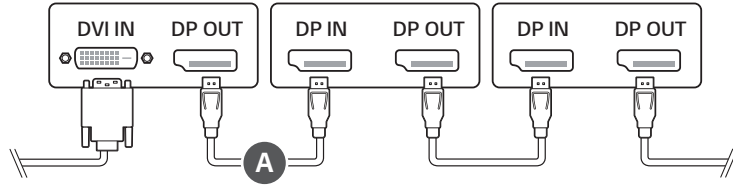
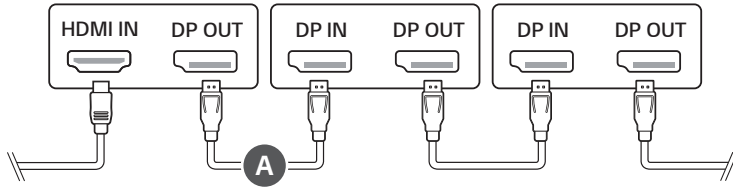
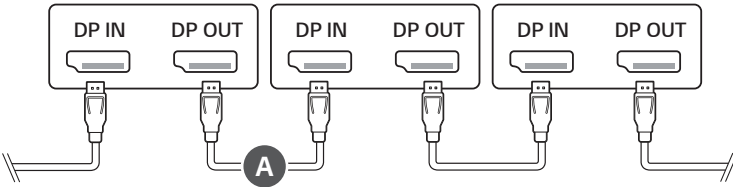

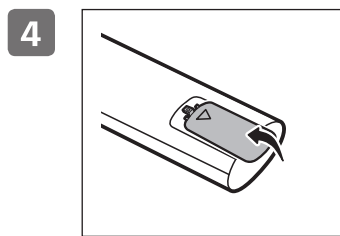
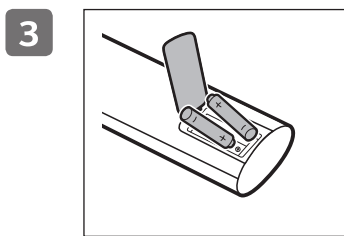
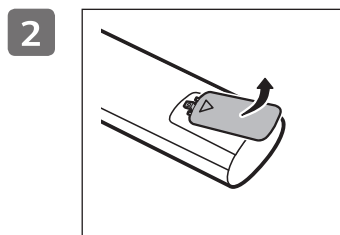
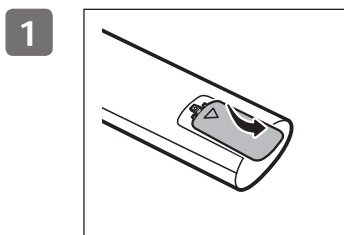
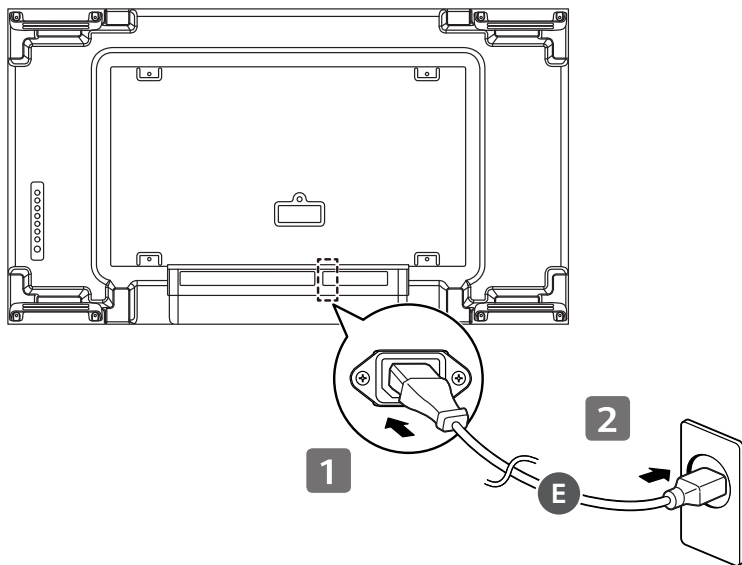



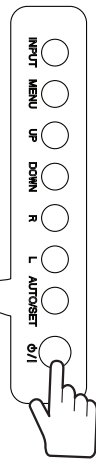
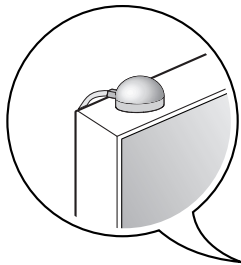







(1910-REV01)

