

User Manual

S27B80*T

The colour and the appearance may differ depending on the product, and the specifications are subject to change without prior notice to improve the performance.

The contents of this manual are subject to change without notice to improve quality.

© Samsung

Samsung owns the copyright for this manual.

Use or reproduction of this manual in parts or entirety without the authorization of Samsung is prohibited.

Trademarks other than that of Samsung are owned by their respective owners.

An administration fee may be charged in the following situations:

- (a) An engineer is called out at your request, but it is found that the product has no defect (i.e., where the user manual has not been read).
- (b) You bring the unit to a repair centre, but it is found that the product has no defect (i.e., where the user manual has not been read).

You will be informed of the administration fee amount before a technician visits.

Table of contents

Before Using the Product

Safety Precautions	4
Electricity and Safety	4
Installation	5
Operation	6

Cleaning	7
----------	---

Correct posture to use the product	8
------------------------------------	---

Preparations

Installation	9
Attaching the Stand	9
Precautions for moving the product	10
Checking the space around the product	10
Adjusting the Product Tilt and Height	11
Rotating the Product	12
Anti-theft Lock	13
Wall Mount Kit Specifications (VESA)	13

Control Panel	14
---------------	----

Direct Key Guide	15
------------------	----

Connecting and Using a Source Device

Read below before connecting the product.	16
---	----

Ports	17
-------	----

Connecting and Using a PC	18
Connection Using the HDMI Cable	18
Connection Using an HDMI-DVI Cable	18
Connection Using a Thunderbolt™ 4 Cable or USB Type-C Cable	19
Connecting the Dual display (daisy chain)	20
Connecting to headphones or earphones	20
Connecting the Power	20
Connecting the Product to a PC as a USB HUB	21

Tidying Up the Connected Cables	22
---------------------------------	----

Setting Optimum Resolution	22
----------------------------	----

List of graphic cards supporting HDR10	22
--	----

Menu

Picture	23
---------	----

Eye Care	28
----------	----

PIP/PBP	28
---------	----

OnScreen Display	30
------------------	----

System	31
--------	----

Support	34
---------	----

Installing the Software

Easy Setting Box	35
Restrictions and Problems with the Installation	35
System Requirements	35

Driver Installation	35
---------------------	----

Table of contents

Troubleshooting Guide

Requirements Before Contacting Samsung Customer Service Centre	36
Product diagnosis (Screen issue)	36
Checking the Resolution and Frequency	36
Check the following.	36

Q & A	39
-------	----

Specifications

General	40
---------	----

Standard Signal Mode Table	41
----------------------------	----

Appendix

Responsibility for the Pay Service (Cost to Customers)	43
Not a product defect	43
A Product damage caused by customer's fault	43
Others	43

Chapter 01

Before Using the Product

Safety Precautions

Warning

A serious or fatal injury may result if instructions are not followed.







Caution

Personal injury or damage to properties may result if instructions are not followed.

CAUTION

RISK OF ELECTRIC SHOCK. DO NOT OPEN.

CAUTION: TO REDUCE THE RISK OF ELECTRIC SHOCK, DO NOT REMOVE COVER (OR BACK). THERE ARE NO USER SERVICEABLE PARTS INSIDE. REFER ALL SERVICING TO QUALIFIED PERSONNEL.

	This symbol indicates that high voltage is present inside. It is dangerous to make any kind of contact with any internal part of this product.		AC voltage: Rated voltage marked with this symbol is AC voltage.
	This symbol indicates that this product has included important literature concerning operation and maintenance.		DC voltage: Rated voltage marked with this symbol is DC voltage.
	Class II product: This symbol indicates that a safety connection to electrical earth (ground) is not required. If this symbol is not present on a product with a mains lead, the product MUST have a reliable connection to protective earth (ground).		Caution. Consult instructions for use: This symbol instructs the user to consult the user manual for further safety related information.

Electricity and Safety

Warning

- Do not use a damaged power cord or plug, or a loose power socket.
- Do not use multiple products with a single power socket.
- Do not touch the power plug with wet hands.
- Insert the power plug all the way in so it is not loose.
- Connect the power plug to a grounded power socket (type 1 insulated devices only).
- Do not bend or pull the power cord with force. Be careful not to leave the power cord under a heavy object.
- Do not place the power cord or product near heat sources.
- Clean any dust around the pins of the power plug or the power socket with a dry cloth.

Caution

- Do not disconnect the power cord while the product is being used.
- Only use the power cord provided with your product by Samsung. Do not use the power cord with other products.
- Keep the power socket where the power cord is connected unobstructed.
 - The power cord must be disconnected to cut off power to the product when an issue occurs.
- Hold the plug when disconnecting the power cord from the power socket.

Installation

Warning

- DO NOT PLACE CANDLES, INSECT REPELLANTS OR CIGARETTES ON TOP OF THE PRODUCT. DO NOT INSTALL THE PRODUCT NEAR HEAT SOURCES.
- Keep the plastic packaging out of the reach of children.
 - Children may suffocate.
- Do not install the product on an unstable or vibrating surface (insecure shelf, sloped surface, etc.)
 - The product may fall and become damaged and/or cause an injury.
 - Using the product in an area with excess vibration may damage the product or cause a fire.
- Do not install the product in a vehicle or a place exposed to dust, moisture (water drips, etc.), oil, or smoke.
- Do not expose the product to direct sunlight, heat, or a hot object such as a stove.
 - The product lifespan may be reduced or a fire may result.
- Do not install the product within the reach of young children.
 - The product may fall and injure children.
- Edible oil (such as soybean oil) may damage or distort the product. Keep the product away from oil pollution. And do not install or use the product in the kitchen or near the kitchen stove.

Caution

- Do not drop the product while moving.
- Do not set down the product on its front.
- When installing the product on a cabinet or shelf, make sure that the bottom edge of the front of the product is not protruding.
 - The product may fall and become damaged and/or cause an injury.
 - Install the product only on cabinets or shelves of the right size.
- Set down the product gently.
 - Product failure or personal injury may result.
- Installing the product in an unusual place (a place exposed to a lot of fine dust, chemical substances, extreme temperatures or a significant presence of moisture, or a place where the product will operate continuously for an extended period of time) may seriously affect its performance.
 - Be sure to consult Samsung Customer Service Centre if you want to install the product at such a place.
- Before assembling the product, place the product down on a flat and stable surface so that the screen is facing downwards.
- In the same series, the colour can vary depending on the size.

Operation

Warning

- There is a high voltage inside the product. Never disassemble, repair or modify the product yourself.
 - Contact Samsung Customer Service Centre for repairs.
 - To move the product, first disconnect all the cables from it, including the power cable.
 - If the product generates abnormal sounds, a burning smell or smoke, disconnect the power cord immediately and contact Samsung Customer Service Centre.
 - Do not let children hang from the product or climb on top of it.
 - Children may become injured or seriously harmed.
 - If the product is dropped or the outer case is damaged, turn off the power and disconnect the power cord. Then contact Samsung Customer Service Centre.
 - Continued use can result in a fire or electric shock.
 - Do not leave heavy objects or items that children like (toys, sweets, etc.) on top of the product.
 - The product or heavy objects may fall as children try to reach for the toys or sweets resulting in a serious injury.
 - During a lightning or thunderstorm, power off the product and remove the power cable.
 - Do not drop objects on the product or apply impact.
 - Do not move the product by pulling the power cord or any cable.
 - If a gas leakage is found, do not touch the product or power plug. Also, ventilate the area immediately.
 - Do not lift or move the product by pulling the power cord or any cable.
 - Do not use or keep combustible spray or an inflammable substance near the product.
 - Ensure the vents are not blocked by tablecloths or curtains.
 - An increased internal temperature may cause a fire.
- Do not insert metallic objects (chopsticks, coins, hairpins, etc) or objects that burn easily (paper, matches, etc) into the product (via the vent or input/output ports, etc).
 - Be sure to power off the product and disconnect the power cord when water or other foreign substances have entered the product. Then contact Samsung Customer Service Centre.
 - Do not place objects containing liquid (vases, pots, bottles, etc) or metallic objects on top of the product.
 - Be sure to power off the product and disconnect the power cord when water or other foreign substances have entered the product. Then contact Samsung Customer Service Centre.

Caution

- Leaving the screen fixed on a stationary image for an extended period of time may cause afterimage burn-in or defective pixels.
 - Set the screen to power-saving mode or moving-picture screen saver when not using the product for an extended period of time.
- Disconnect the power cord from the power socket if you do not plan on using the product for an extended period of time (vacation, etc).
 - Dust accumulation combined with heat can cause a fire, electric shock or electric leakage.
- Use the product at the recommended resolution and frequency.
 - Your eyesight may deteriorate.
- Do not hold the product upside-down or move it by holding the stand.
 - The product may fall and become damaged or cause an injury.
- Looking at the screen too close for an extended period of time can deteriorate your eyesight.
- Do not use humidifiers or stoves around the product.
- Rest your eyes for more than 5 minutes or look at distance objects for every 1 hour of product use.
- Do not touch the screen when the product has been turned on for an extended period of time as it will become hot.
- Store small accessories out of the reach of children.
- Exercise caution when adjusting the product angle or stand height.
 - Your hand or finger may get stuck and injured.
 - Tilting the product at an excessive angle may cause the product to fall and an injury may result.
- Do not place heavy objects on the product.
 - Product failure or personal injury may result.
- When using headphones or earphones, do not turn the volume too high.
 - Having the sound too loud may damage your hearing.

Cleaning

High-glossy models can develop white stains on the surface if an ultrasonic wave humidifier is used nearby.

— Contact your nearest Samsung Customer Service Centre if you want to clean the inside of the product (Service fee will be charged.)

Do not press the product screen with hands or other objects. There is a risk of damaging the screen.

— Exercise care when cleaning as the panel and exterior of advanced LCDs are easily scratched.

Take the following steps when cleaning.

- 1 Power off the product and PC.
 - Hold the power cable by the plug and do not touch the cable with wet hands. Otherwise, an electric shock may result.
- 2 Disconnect the power cord from the product.
 - Wipe the product with a clean, soft and dry cloth.
Wet a soft cloth in water, wring it out well, and then use the cloth to wipe the exterior of the product clean.
 - Do not apply a cleaning agent that contains alcohol, solvent, or surfactant to the product.
 - Do not spray water or detergent directly on the product.
- 4 Connect the power cord to the product when cleaning is finished.
- 5 Power on the product and PC.

Correct posture to use the product



Use the product in the correct posture as follows:

- Straighten your back.
- Allow a distance of 45 to 50cm between your eye and the screen, and look slightly downward at the screen.
- Keep your eyes directly in front of the screen.
- Adjust the angle so light does not reflect on the screen.
- Keep your forearms perpendicular to your upper arms and level with the back of your hands.
- Keep your elbows at about a right angle.
- Adjust the height of the product so you can keep your knees bent at 90 degrees or more, your heels attached to the floor, and your arms lower than your heart.
- Do the Eye exercises or blink frequently, then eye fatigue will be relieved.

Chapter 02

Preparations

Installation

Attaching the Stand

- Before assembling the product, place the product down on a flat and stable surface so that the screen is facing downwards.
- Disassembly is the reverse order of assembly.

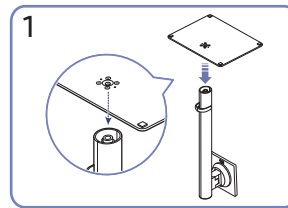
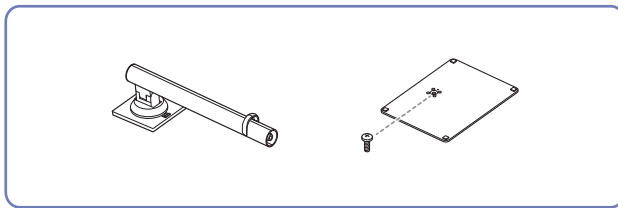

Put the stand base onto the stand neck as the direction shown in the figure. Check that the stand neck is firmly connected.

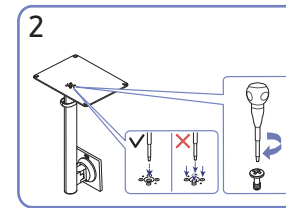

Tightly fasten the connecting screw at the bottom of the stand base. Fasten the large screw in the middle for assembly.

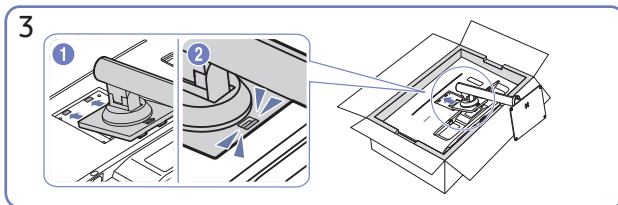

Push the assembled stand into the main body in the direction of the arrow as shown in the figure.

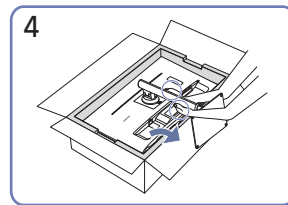

Stand up the monitor as shown in the figure.

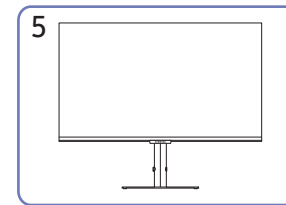

After installing the stand, place the product upright.

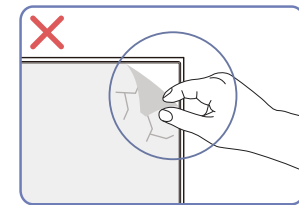

Caution
Do not arbitrarily remove the panel film. If not observed, the warranty service may be restricted.

Precautions for moving the product

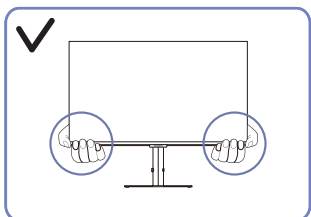

- Hold the lower corners or edges of the product when moving it.

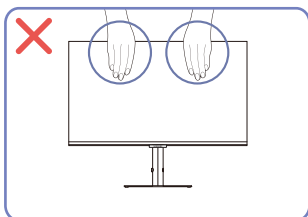

- Do not directly apply pressure on the screen.
- Do not hold the screen when moving the product.

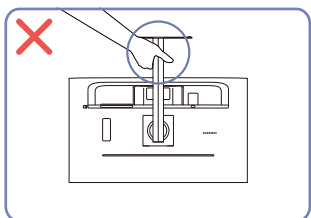

- Do not hold the product upside down only by the stand.

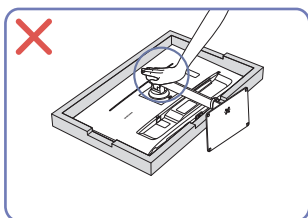

- Do not press down on the product. There is a risk of damaging the product.

Checking the space around the product

Make sure to have enough space for ventilation when placing the product. An internal temperature rise may cause fire and damage the product. Maintain enough space around the product as shown in the diagram when installing the product.

— The exterior may differ depending on the product.

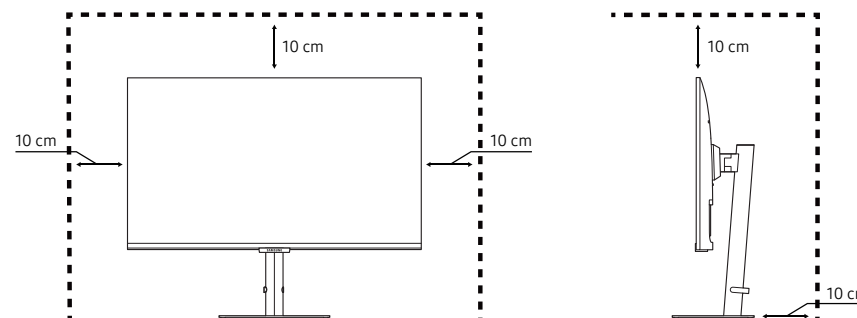

Adjusting the Product Tilt and Height

The colour and shape of parts may differ from what is shown. Specifications are subject to change without notice to improve quality.

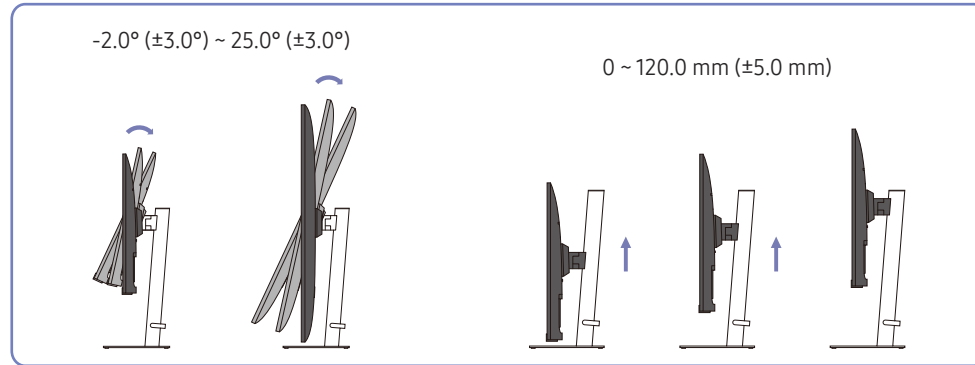

- The product tilt and height can be adjusted.
- Hold the top centre of the product and adjust the height carefully.
- The height adjustment has a certain tolerance. Stay within the tolerances when adjusting the height of the product.

Caution

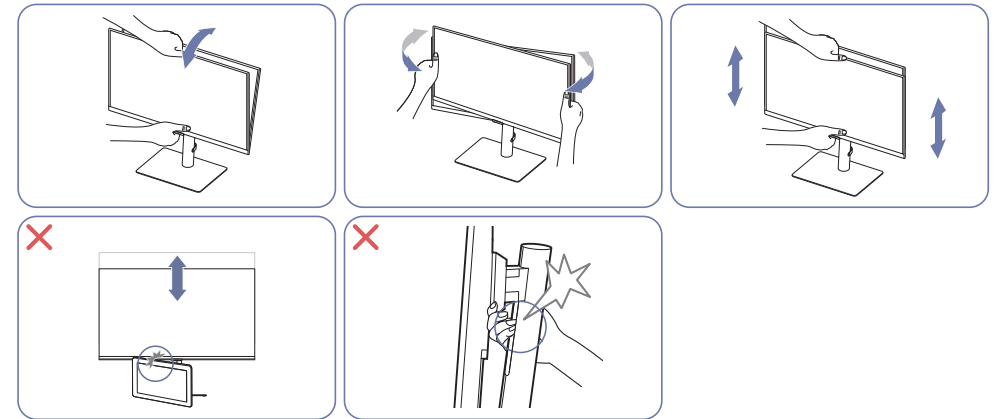

- Grasp the left and right sides of the monitor and adjust the swivel.
- Grasp the centre of the monitor and adjust the height.
- Do NOT hold the stand moving part with your hand when leveling the screen. Your hand may get hurt.
- Do not put an object around the lower part of the product. The product or object may get damaged when adjusting the product height.

After adjusting the product tilt and height, if the screen is not level, take the following actions.

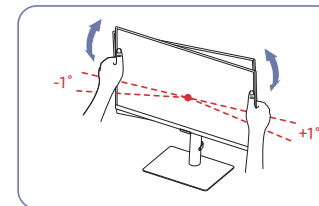

- Hold the bezel at both side edges and adjust the monitor angle until the screen becomes level. (Be careful not to directly hold the LCD display.)
- The monitor angle can be adjusted from -1° to $+1^\circ$.

Rotating the Product

— The colour and shape of parts may differ from what is shown. Specifications are subject to change without notice to improve quality.

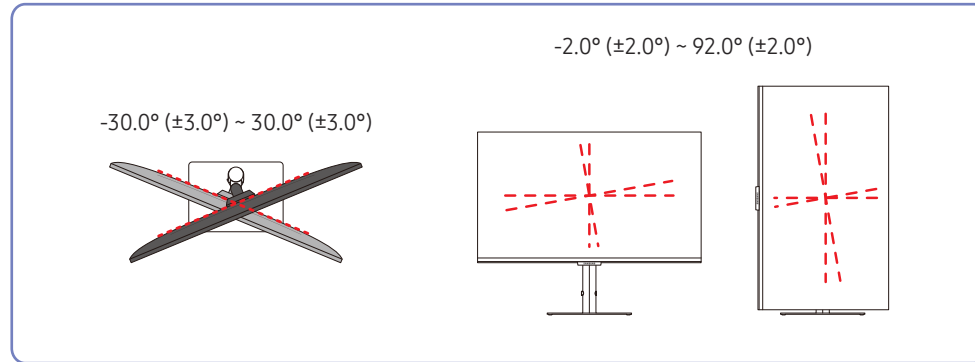

You can rotate your product as shown below.

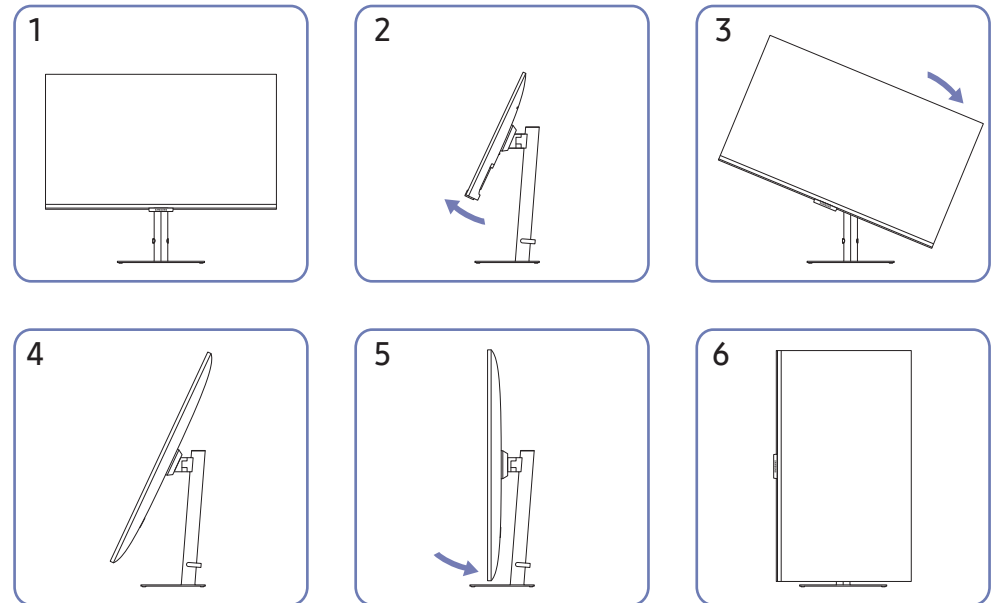

- Be sure to fully extend the stand before rotating the product.
- If you rotate the product without fully extending the stand, the corner of the product may hit the floor and get damaged.
- Do not rotate the product counterclockwise. The product may get damaged.
- When rotating the product, be careful not to damage the product by hitting the object or stand.

Anti-theft Lock

- An anti-theft lock allows you to use the product securely even in public places.
- The locking device shape and locking method depend on the manufacturer. Refer to the manuals provided with your anti-theft locking device for details.

To lock an anti-theft locking device:

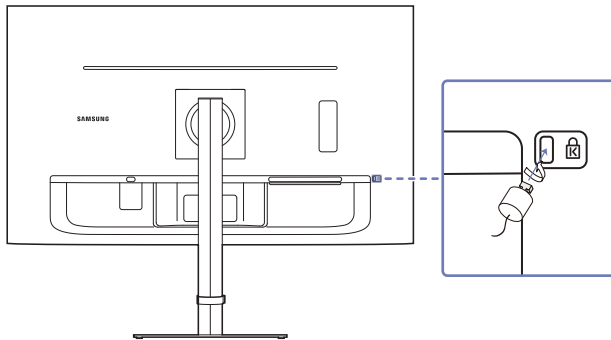

- 1 Fix the cable of your anti-theft locking device to a heavy object such as a desk.
- 2 Put one end of the cable through the loop on the other end.
- 3 Insert the locking device into the anti-theft lock slot at the back of the product.
- 4 Lock the locking device.
 - An anti-theft locking device can be purchased separately.
 - Anti-theft locking devices can be purchased at electronics retailers or online.

Wall Mount Kit Specifications (VESA)

- Install your wall mount on a solid wall perpendicular to the floor. Before attaching the wall mount to surfaces other than plaster board, please contact your nearest dealer for additional information. If you install the product on a slanted wall, it may fall and result in severe personal injury. Samsung wall mount kits contain a detailed installation manual and all parts necessary for assembly are provided.
- Do not use screws that are longer than the standard length or do not comply with the VESA standard screw specifications. Screws that are too long may cause damage to the inside of the product.
- For wall mounts that do not comply with the VESA standard screw specifications, the length of the screws may differ depending on the wall mount specifications.
- Do not fasten the screws too firmly. This may damage the product or cause the product to fall, leading to personal injury. Samsung is not liable for these kinds of accidents.
- Samsung is not liable for product damage or personal injury when a non-VESA or non-specified wall mount is used or the consumer fails to follow the product installation instructions.
- Do not mount the product at more than a 15 degree tilt.
- Standard dimensions for wall mount kits are shown in the table below.

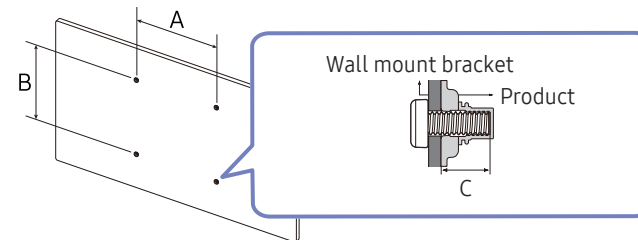

Model name	VESA screw hole specs (A * B) in millimetres	C	Standard Screw	Quantity
S27B80*T	100.0 x 100.0	5.5 ~ 7.5 mm	M4	4 EA

- Do not install your Wall Mount Kit while your product is turned on. It may result in personal injury due to electric shock.

Control Panel

The colour and shape of parts may differ from what is shown. Specifications are subject to change without notice to improve quality.

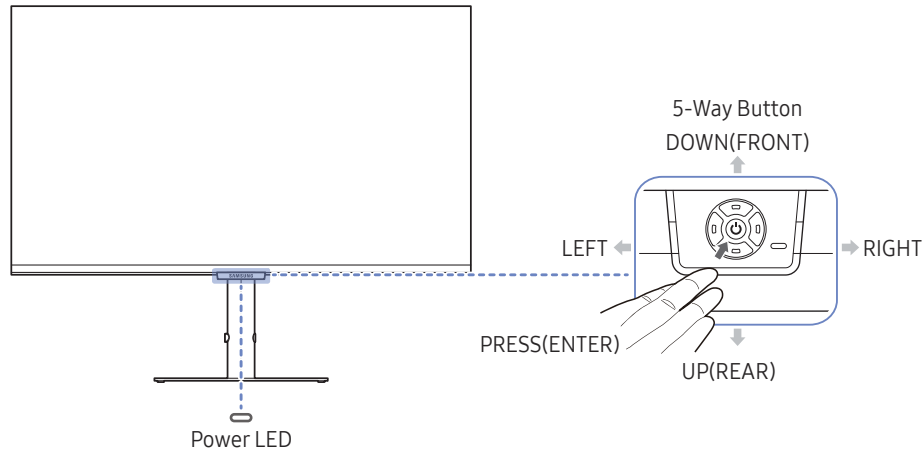

Function Key Guide

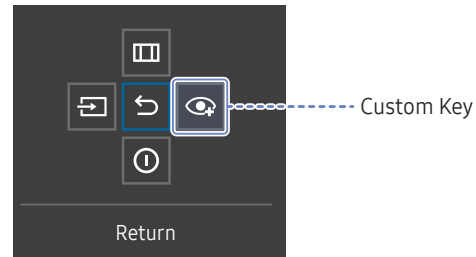

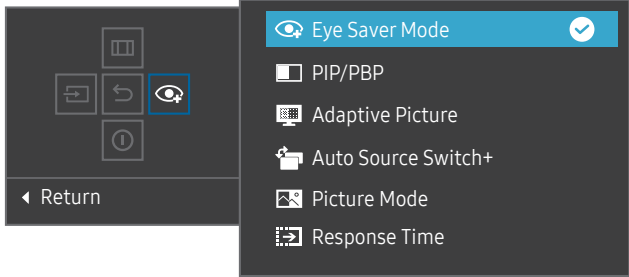
Parts	Description
5-Way Button	Multi directional button that helps navigate.
Power LED	This LED is power status indicator. You can select the power LED operation to be enabled or disabled on the menu screen. (Menu → System → Power LED On)
Function Key Guide	To use the Function Key Guide, press the 5-Way Button when the screen is turned on. <ul style="list-style-type: none"> Custom Key is used to directly access the function set in Setup Custom Key. Setup Custom Key
Custom Key	 <p>Go to (Menu → System → Setup Custom Key) and change the custom key.</p>
Source	Changes the input source. A message will appear on the top left corner of the screen if the input source has been changed.
Menu	Displays the main on-screen menu. To enable or disable the menu lock, move to the next step (move the 5-Way Button to the right) with the "Menu" displayed, and then push the 5-Way Button to the left for 10 seconds until the menu screen disappears. If the menu lock is enabled, Brightness, Contrast, Eye Saver Mode, Volume and Information are available.
Power Off	Turns off the product.
Return	Exits from the menu page.

Direct Key Guide

— On the Direct Key Guide screen, the following menu options appear when the product screen is switched on or the input source is changed.

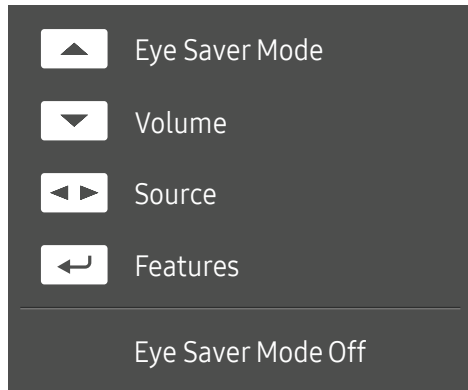

— The Direct Key Guide screen shows if **Eye Saver Mode** is enabled. (**Off, Low, High**)

— When the product not displays the OSD menu, the 5-Way Button could be used as below.

- UP: Adjust **Brightness, Contrast, Eye Saver Mode**.
- DOWN: Adjust **Volume, Mute**.
- LEFT/RIGHT: Adjust **Source**.
- PRESS(ENTER): Display Function Key Guide.

Chapter 03

Connecting and Using a Source Device

Read below before connecting the product.

- 1 Before connecting the product, check the shapes of both ports of the supplied signal cables and the shapes and locations of the ports on the product and external device.
 - 2 Before connecting the product, make sure you remove the power cables from both the product and the external device to prevent damage to the product due to a short circuit or over current.
 - 3 After all signal cables have been properly connected, connect the power cables back to the product and the external device.
 - 4 After connecting is completed, make sure you read the manuals to acquaint yourself with the product functions, precautions and other information required to use the product properly.
- Connecting parts may differ in different products.
 - Provided ports may vary depending on the product.

Ports

The functions available may vary depending on the product model. The colour and shape of parts may differ from what is shown. Specifications are subject to change without notice to improve quality. Refer to the actual product.

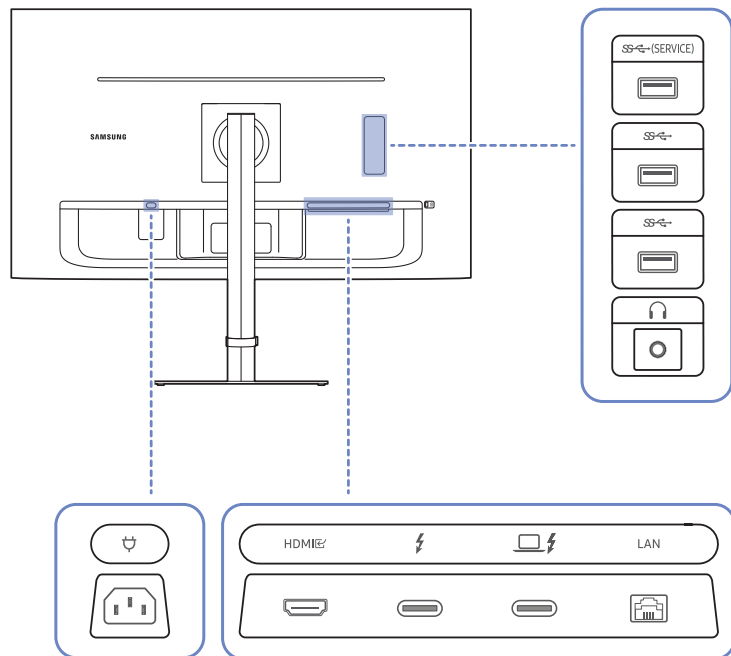

Port	Description
	Connect to an audio output device such as headphones.
(SERVICE)	<ul style="list-style-type: none"> Connect to a USB device. Used to update the software.
	<ul style="list-style-type: none"> Connect to a USB device. These ports are enabled when a PC is connected to the port using a Thunderbolt™ 4 cable or USB Type-C cable.
	<p>Connect to a device using a Thunderbolt™ 4 cable or USB Type-C cable.</p> <ul style="list-style-type: none"> is Thunderbolt™ 4 downstream port. <ul style="list-style-type: none"> With 15 W PD output. is Thunderbolt™ 4 upstream port. <ul style="list-style-type: none"> With 90 W PD output. To connect to a PC via Thunderbolt, connect the cable to the port, one of the two Thunderbolt ports.
LAN	<p>If a PC is connected to the monitor using a Thunderbolt™ 4 cable or USB Type-C cable, connect a LAN cable to this port to connect the PC to the network.</p> <ul style="list-style-type: none"> Use Cat7(*STP Type) cable for the connection. (10/100 Mbps) *Shielded Twisted Pair
	Connect to a source device using an HDMI cable or HDMI-DVI cable.
	Connect the power cord for product.

Connecting and Using a PC

Select a connection method suitable for your PC.

Connection Using the HDMI Cable



- It is recommended to use the HDMI cable provided as components. If not provided, be sure to use authorised cable for HDMI cable connections. If you use a unauthorised HDMI cable, the image quality may be degrade.

Connection Using an HDMI-DVI Cable



- When using HDMI-DVI cable, audio may not be supported according to source device.
- The optimum resolution may not be available with an HDMI-DVI cable.

Connection Using a Thunderbolt™ 4 Cable or USB Type-C Cable

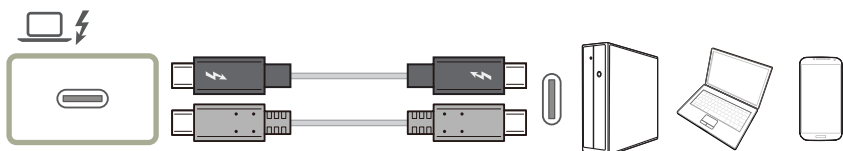



According to the USB Power Delivery 3.0 specification, our product can charge your PC when you connect it to our product using a Thunderbolt™ 4 cable.

To get the full experience of the Thunderbolt™ 4 technology, connect a PC that supports this technology using a Thunderbolt™ 4 cable and ensure that all connected devices and cables are approved by Intel Thunderbolt. For detailed approval information, visit the official Intel website.

Before using the product, update the BIOS programme, Thunderbolt firmware, and Thunderbolt software of your PC to their latest versions by visiting the official website of your PC.

Although there are two Thunderbolt™ 4 ports, only the first connected Thunderbolt™ 4 host can be identified as the host device. For detailed connecting specification of Thunderbolt™ 4 port, please visit the official website of Thunderbolt.

- If you want to charge your PC, make sure that your PC supports power input. Many Thunderbolt™ 4-compatible PCs do not support charging over a USB Type-C port, and some PCs can charge only their own branded power adapters. Because PC released in the market are very various, we cannot guarantee that our product can charge all types of PC over a Thunderbolt™ 4 port.
- Unlike USB devices, Thunderbolt™ 4 devices must be manually authenticated through Intel's Thunderbolt programme before the system recognises them.
- Considering that it takes a relatively long time to complete the connection and disconnection over Thunderbolt, do not quickly plug in and unplug the signal cable or power cable. Otherwise, your devices may be damaged.
- When connecting an external device that exceeds the charging capacity of the Thunderbolt™ 4/USB-C port, be sure to use the adapter dedicated to the device. (For charging capacities for each port, see the product specifications in the Samsung website (<http://www.samsung.com>). Be sure to use MacOS after upgrading to Catalina 10.15.5 or higher.
- When connecting a notebook or laptop computer, it is recommended to connect the  port.
- Make sure that the Thunderbolt™ 4 or USB Type-C cable complies with the Thunderbolt™ 4 or USB Type-C specification. Otherwise, your devices may be damaged. A Samsung branded cable is recommended.
- Because of compatibility with the Thunderbolt technology, phones that support the USB Type-C display may not be displayed on our product. To fix this problem, you may need to upgrade the firmware from your phone's manufacturer.
- Connect the Thunderbolt™ 4 cable to a PC that supports Thunderbolt™ 4 and connect the USB Type-C cable to a PC that supports USB Type-C.
- Each Thunderbolt port supports a transfer rate of 40 Gb/s at maximum.
- Make sure to use a certified Thunderbolt™ 4 cable. Otherwise, product malfunctions may occur.
- The availability of some functions may vary, depending on the PC.
- To connect to a PC via Thunderbolt, connect the cable to the  port, one of the two Thunderbolt ports.

Connecting the Dual display (daisy chain)

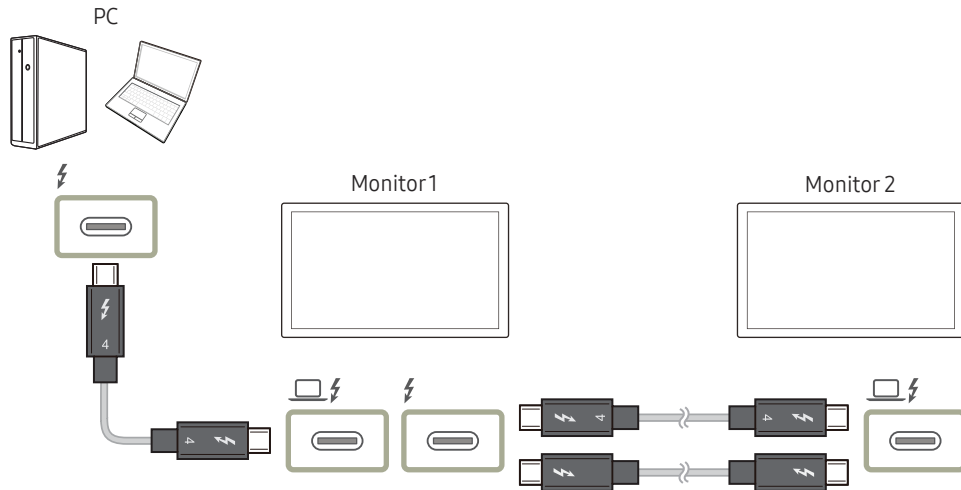

Dual display (daisy chain) support depends on your PC and the connected Thunderbolt™ 4 cable. The Thunderbolt™ 4 port on your PC must support dual 4 K @ 60 Hz output, and the particular 40Gbps Thunderbolt™ 4 cable (🔌) need to be purchased separately. For detailed specification of the Thunderbolt™ 4 cable, visit the official Thunderbolt website.

- To achieve 4K 60Hz x 2 display daisy chain on this monitor, a certificated Thunderbolt™ 4 PC and Thunderbolt 4™ cable that support transmission speed up to 40 Gbps are required.
- The availability of some functions may vary, depending on the PC.

Connecting to headphones or earphones

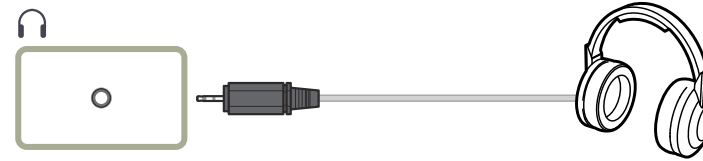

Connecting the Power

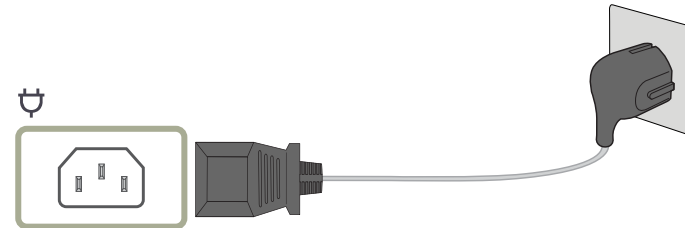



To use the product, connect the power cable to a power outlet and the ⚡ port on the product.

- The input voltage is switched automatically.

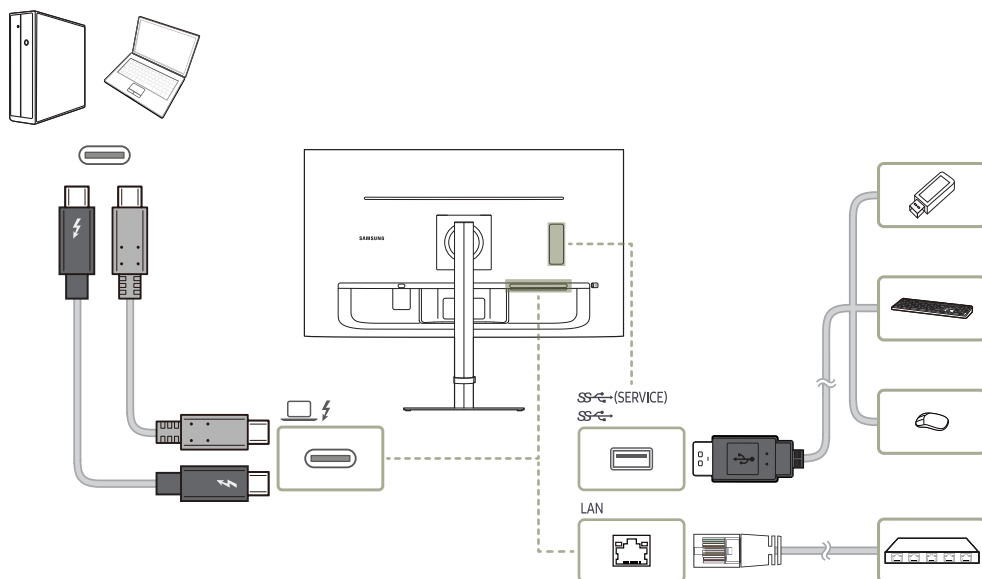
Connecting the Product to a PC as a USB HUB



Using the product as a hub, connect and use various source devices with the product at a time.

To establish a LAN connection, use a Thunderbolt™ 4 cable:  port or USB Type-C cable:  port.

- With some PCs, network connection via LAN may not be supported.
- To detect and start a USB device faster, connect the USB device to the  port on the product. The read/write rate will be affected by the USB device and your PC.
- For USB-related problems caused by OS, drive programmes or software, please contact relevant suppliers.
- With the launch of various USB devices on the market, we cannot guarantee that our products are matched with all USB devices.
- For an external mass-storage HDD requiring external power supply, be sure to connect it to a power source.
- The company is not liable for problems or damages to an external device caused by using an unauthorised cable for the connection.
- Some products do not follow the USB standard, and it may cause a malfunction of the device.

Tidying Up the Connected Cables

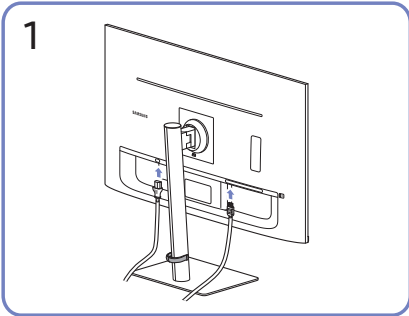

1
Connect the corresponding cables.

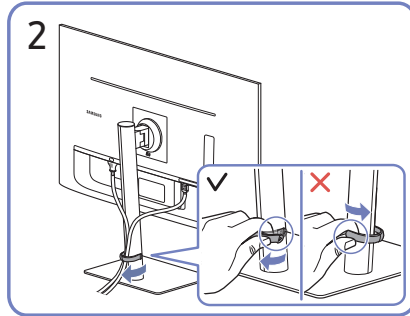

2
Pull the right side of the HOLDER-STAND CABLE to remove from the stand. The left side of the HOLDER-STAND CABLE can be damaged when pulled forcibly.

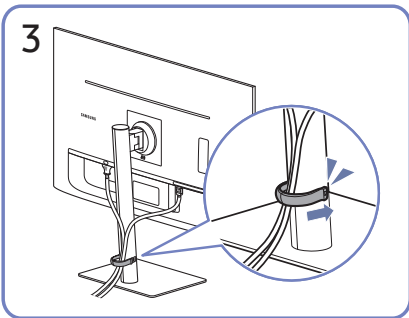

3
Put both cables in the cable holder on the stand (HOLDER-STAND CABLE) to organise the cables, as shown in the figure.

Assembly is complete.

Setting Optimum Resolution

An information message about setting optimum resolution will appear if you power on the product for the first time after purchase.

Select a language on information message and change the resolution on your PC to the optimum setting.

- If the optimum resolution is not selected, the message will appear up to three times for a specified time even when the product is turned off and on again.
- If you want to set the optimum resolution for your computer. Please refer to (Q&A) → [“How can I change the resolution?”](#)

List of graphic cards supporting HDR10

HDR10 is accessible only on Windows 10 systems equipped with graphic cards that support Play Ready 3.0 Digital Rights Management (for protected HDR content). Use graphic cards listed below for HDR10.

- NVIDIA GeForce 1000 series or higher
 - AMD Radeon™ RX 400 series or higher
 - Intel UHD Graphics 600 series or higher
- Graphic cards that support hardware-accelerated 10-bit video decoding for HDR video codecs are recommended.

Chapter 04

Menu

Function Key Guide → 

— The functions available may vary depending on the product model. The colour and shape of parts may differ from what is shown. Specifications are subject to change without notice to improve quality.

Picture

2nd	3rd	Description
Picture Mode		<p>This menu provides an optimum picture quality suitable for the environment where the product will be used.</p> <p>— This menu is not available when Eco Saving Plus is enabled.</p> <p>— This menu is not available when Eye Saver Mode is enabled.</p> <p>— This menu is not available when PIP/PBP Mode is enabled.</p> <p>In PC mode</p> <ul style="list-style-type: none">• Custom: Customise the screen settings.• High Bright: Make the screen look brighter than sRGB mode.• sRGB: Adjust the colour system to sRGB mode. This is the standard mode of this monitor.• Cinema: Obtain the brightness and sharpness of monitors suitable for enjoying video and DVD content.• Dynamic Contrast: Obtain balanced brightness through automatic contrast adjustment.

2nd	3rd	Description
Picture Mode		<p>In AV mode</p> <p>When the external input is connected through HDMI, Thunderbolt™ 4/USB-C and PC/AV Mode is set to AV, Picture Mode has three automatic picture settings (Dynamic, Standard and Movie) that are preset at the factory. You can activate either Dynamic, Standard, Movie.</p> <ul style="list-style-type: none"> • Dynamic: Select this mode to view a sharper image than in Standard mode. • Standard: Select this mode when the surroundings are bright. • Movie: Select this mode when the surroundings are dark. This will save power and reduce eye fatigue.
Brightness		<p>You can adjust the general brightness of the picture. (Range: 0~100)</p> <p>A higher value will make the picture appear brighter.</p> <p>— This menu is not available when Eye Saver Mode is enabled.</p> <p>— This menu is not available when Eco Saving Plus is enabled.</p>
Contrast		<p>Adjust the contrast between the objects and background. (Range: 0~100)</p> <p>A higher value will increase the contrast to make the object appear clearer.</p> <p>— This menu is not available when Picture Mode is set to sRGB mode.</p> <p>— This menu is not available when PIP/PBP Mode is enabled.</p> <p>— This menu is not available when Game Mode is enabled.</p>

2nd	3rd	Description
Sharpness		<p>Make the outline of objects more clear or blurry. (Range: 0~100)</p> <p>A higher value will make the outline of objects clearer.</p> <p>— This menu is not available when PIP/PBP Mode is enabled.</p> <p>— This menu is not available when Game Mode is enabled.</p>
Color		<p>Adjust the tint of the screen.</p> <ul style="list-style-type: none"> • Red: Adjust the red saturation level. Values closer to 100 mean greater intensity for the colour. • Green: Adjust the green saturation level. Values closer to 100 mean greater intensity for the colour. • Blue: Adjust the blue saturation level. Values closer to 100 mean greater intensity for the colour. • Color Tone: Select a colour tone that best suits your viewing needs. • Gamma: Adjust the middle level of luminance. • Saturation: Adjust the saturation level. Values closer to 100 mean greater intensity for the colour. <p>— This menu is not available when Picture Mode is set to Cinema, High Bright or sRGB mode.</p> <p>— This menu is not available when Game Mode is enabled.</p> <p>— This menu is not available when Eye Saver Mode is enabled.</p> <p>— This menu is not available when PIP/PBP Mode is enabled.</p>
Contrast Enhancer		<p>Automatically balance the contrast to prevent excessive differences between bright and dark areas.</p>







2nd	3rd	Description
Black Level		<p>If a DVD player or set-top box etc is connected to the product via HDMI, image quality degradation (contrast/colour degradation, black level, etc.) may occur, depending on the connected source device.</p> <p>In such case, Black Level can be used to adjust the image quality.</p> <ul style="list-style-type: none"> • Normal / Low <p>— This function is only available in HDMI mode.</p> <p>— This menu is not available when PIP/PBP Mode is enabled.</p> <p>— Black Level may not be compatible with some source devices.</p> <p>— The Black Level feature is only activated at a certain AV resolution, such as 480p @ 60 Hz, 576p @ 50 Hz, 720p @ 60 Hz and 1080p @ 60 Hz.</p>
Game Mode		<p>Configure the product screen settings for game mode.</p> <p>Use this feature when playing games on a PC or when a game console such as PlayStation™ or Xbox™ is connected.</p> <p>— This menu is not available when PIP/PBP Mode is enabled.</p> <p>— When the product turns off, enters power-saving mode or changes input sources, Game Mode turns Off even if it is set to On.</p> <p>— If you want to keep Game Mode enabled all the time, select Always On.</p>
Response Time		<p>Accelerate the panel response rate to make video appear more vivid and natural.</p> <p>— Use Standard mode when not playing a video or game.</p> <p>— This menu is not available when PIP/PBP Mode is enabled.</p>



2nd	3rd	Description
Screen Ratio		<p>Change the picture size.</p> <p>In PC mode</p> <ul style="list-style-type: none"> • Auto / Wide <p>In AV mode</p> <ul style="list-style-type: none"> • 4:3 / 16:9 / Screen Fit <p>— The function may not be supported depending on the ports provided with the product.</p> <p>— Changing the Screen Ratio is available when the following conditions are satisfied.</p> <ul style="list-style-type: none"> — The input source is 480p, 576p, 720p or 1080p and product can display normally (Not every model can support all of these signals.). — This can only be set when the external input is connected through HDMI, Thunderbolt™ 4/USB-C and PC/AV Mode is set to AV.
Screen Adjustment		<p>Adjust the position of the screen or increase the picture quality.</p> <ul style="list-style-type: none"> • H-Position: Move the screen to the left or right. • V-Position: Move the screen up or down. <p>— Connection Using the HDMI, Thunderbolt™ 4/USB-C Cable.</p> <p>— This menu is only available when Screen Ratio is set to Screen Fit in AV Mode.</p> <p>When a 480p, 576p, 720p or 1080p signal is input in AV mode and the product can display normally, select Screen Fit to adjust horizontal position and vertical position in 0-6 levels.</p>

Eye Care

2nd	3rd	Description
Adaptive Picture		Optimises brightness and provides the best picture quality in real time, based on the lighting condition and the content you're viewing. — This menu is not available when Eco Sensor Mode is enabled. — This menu is not available when sRGB is enabled.
Min. Backlight		Minimises screen backlight when running Adaptive Picture. — This menu is not available when sRGB is enabled.
Eye Saver Mode		Set to an optimum picture quality suitable for eye relaxation.

PIP/PBP

2nd	3rd	Description
PIP/PBP Mode		Turn PIP/PBP Mode on or off.
Mode Type		Select the size and aspect ratio of the sub-screen. <ul style="list-style-type: none">•  8:9  8:9 /  PIP
Screen Size		Select sub-screen size. <ul style="list-style-type: none">•  /  /  — This option is available when Mode Type is set to PIP .

2nd	3rd	Description
Screen Position		Select the position of the sub-screen from the available options. <ul style="list-style-type: none">  — This option is available when Mode Type is set to PIP .
Source		Select the source for each screen.
Sound Source		Set which screen you want to hear the sound for. <p>In PIP mode</p> <ul style="list-style-type: none">  <p>In PBP mode</p> <ul style="list-style-type: none"> 
Screen Ratio		Choose the size and aspect ratio of the picture displayed on screen. <p>In PC mode</p> <ul style="list-style-type: none"> Auto / Wide <p>In AV mode</p> <ul style="list-style-type: none"> 4:3 / 16:9 / Screen Fit — The function may not be supported depending on the ports provided with the product. — Changing the Screen Ratio is available when the following conditions are satisfied. <ul style="list-style-type: none"> — The input source is 480p, 576p, 720p or 1080p and product can display normally (Not every model can support all of these signals.). — This can only be set when the external input is connected through HDMI, Thunderbolt™ 4/USB-C and PC/AV Mode is set to AV.
Contrast		Adjust the contrast level. Values closer to 100 mean a bigger light/dark contrast.

OnScreen Display

2nd	3rd	Description
Transparency		Set the transparency for the menu windows.
Position		<ul style="list-style-type: none">• H-Position: Move the menu position to the left or right.• V-Position: Move the menu position up or down.
Language		Set the menu language. — A change to the language setting will only be applied to the onscreen menu display.
Display Time		Set how long the menu window will remain on screen for when it is not in use.
Display Time Info		Show the time left until the menu window disappears. Menu display time can be set in the Menu settings.
Enlarge		Enlarge the size of the Menu area.





System

2nd	3rd	Description
Volume		Change the Volume setting.
Eco Saving Plus		<p>The Eco Saving Plus function reduces power consumption by controlling the electric current used by the monitor panel.</p> <ul style="list-style-type: none"> • Off: Deactivate the Eco Saving Plus function. • Auto: The power consumption will automatically be reduced by about 10% over the current setting. (The reduction of power consumption depends on the customer screen brightness condition.) • Low: Saves up to 25 % energy compared to the maximum brightness. • High: Saves up to 50 % energy compared to the maximum brightness. <p>— This menu is not available when Eye Saver Mode is enabled.</p> <p>— This menu is not available when PIP/PBP Mode is enabled.</p> <p>— This menu is not available when Picture Mode is set to Dynamic Contrast mode.</p>
Off Timer Plus	Off Timer	<ul style="list-style-type: none"> • Off Timer: Turn on Off Timer mode. • Turn Off After: The off timer can be set within a range of 1 to 23 hours. The product will automatically power off after the specified number of hours. <ul style="list-style-type: none"> – This option is only available when Off Timer is set to On. <p>— For products for the market in some regions, the Off Timer is set to automatically activate 4 hours after the product powers on. This is done in accordance with power supply regulations. If you do not want the timer to activate, go to  → System → Off Timer Plus and set Off Timer to Off.</p>
	Eco Timer	<ul style="list-style-type: none"> • Eco Timer: Turn on Eco Timer mode. • Eco Off After: The Eco Timer can be set between 10 and 180 minutes. The product will automatically power off after the specified time has elapsed. <ul style="list-style-type: none"> – This option is only available when Eco Timer is set to On.

2nd	3rd	Description
PC/AV Mode		<p>Set PC/AV Mode to AV. The picture size will be enlarged.</p> <p>This option is useful when you view a movie.</p> <ul style="list-style-type: none"> — Products with a display area of 16:9 or 16:10 are only supported.
Input Port Ver.		<p>Select an HDMI version.</p> <ul style="list-style-type: none"> — The supportable device and resolution may differ depending on its version. — When the version is changed, the screen may blink. — If you set the HDMI Mode to 1.4, some high resolutions may not be supported because of bandwidth limitation of the HDMI 1.4 protocol. — If you set the HDMI Mode to 2.0, some high resolutions may not be supported because of bandwidth limitation of the HDMI 2.0 protocol. — When the setting is not appropriate, a blank screen may appear. In this case, check the specifications of the device.
Auto Source Switch+		<p>When there is no signal, the display automatically switches to the newly connected device.</p> <ul style="list-style-type: none"> — This function may not be supported depending on the model or geographical area.
Key Repeat Time		<p>Control the response rate of a button when the button is pressed.</p> <p>Acceleration, 1 sec or 2 sec can be selected. If No Repeat is selected, a command responds only once when a button is pressed.</p>
Power LED On		<p>Configure the settings to enable or disable the power LED located at the lower part of the product.</p> <ul style="list-style-type: none"> • Working: The power LED is on when the product is turned on. • Stand-by: The power LED is on when the product is turned off.

2nd	3rd	Description
Accessibility		<p>Configures the accessibility options.</p> <ul style="list-style-type: none"> • High Contrast: Increase the contrast between the text and background for the Settings menu. • Grayscale: Change the colour sense of the screen to black-and white tone. • Color Inversion: Invert the colours of the Settings menu. White becomes black, black becomes white, and other colours are inverted according to RGB colour values.
Setup Custom Key		Set the custom key so that your chosen function can be set up directly.
Eco Sensor Mode		Optimises brightness in real time, based on your lighting environment.
Max. Power Saving		Set to on, Ethernet is turned off to save power. Set to off, the USB-C connected PC or laptop can be woken by LAN.

Support

2nd	3rd	Description
Self Diagnosis		<p>Perform this test when you experience a problem with your monitor's picture.</p> <ul style="list-style-type: none">Never turn off the power nor change the input source during self diagnosis. If possible, try not to interrupt testing.
Software Update		<p>Update software using an update file on a USB device.</p> <ol style="list-style-type: none">Save the update file (in .bin format) that you downloaded from the Samsung website (http://www.samsung.com/sec) to a USB device.Connect the USB device to the  (SERVICE) port on the monitor. Select  → Support → Software Update.Follow the instructions on the screen to proceed with update.Your product will turn itself off and on again automatically after completing update, and then turn off your product.Remove the power cord from the power outlet and then reconnect the cord after turning off. <ul style="list-style-type: none">To perform software update by using a USB device, first format the USB device to FAT32.When updating by a USB device, be sure to use the device whose version of USB 3.0 or lower.When performing update, make sure that only one BIN file (.bin) is saved in the root directory.If the No USB devices detected. Please check and try again. message is displayed, this is probably due to the following reasons.<ul style="list-style-type: none">A USB device is not connected to the  (SERVICE) port.The files in the connected USB device are not compatible formats.There are no valid update files found in the connected USB device. (There are no update files saved in the memory or the file names are incorrect.)The update will not start if the downloaded software does not match the software installed on the monitor. To check the software for consistency, select  → Support → Information.Do not turn off the product until the update is complete. And prevent the updating from any interruption as far as possible. In general, the product returns to the previous version if an update is interrupted.It may change the screen colour or blink during USB update, but it is not a monitor problem. Since S/W update is performed normally, please wait until the update is finished.
Register Product		Discover how to register your product.
Information		View the current software information. Refer to the actual monitor screen.
Reset All		Return all the settings for the product to the default factory settings.

Chapter 05

Installing the Software

Easy Setting Box



Easy Setting Box enables users to use the product by partitioning multiple sections.

To install the latest version of Easy Setting Box, download it from the Samsung website.

(<http://www.samsung.com>)

- The software may not work properly if you do not restart the PC after the installation.
- The Easy Setting Box icon may not appear depending on the PC system and the product specifications.
- If the shortcut icon does not appear, press the F5 key.

Restrictions and Problems with the Installation

The Easy Setting Box installation may be affected by the Graphics Card, Motherboard and the Networking Environment.

System Requirements

OS	Hardware
<ul style="list-style-type: none">• Windows 7 32Bit/64Bit• Windows 8 32Bit/64Bit• Windows 8.1 32Bit/64Bit• Windows 10 32Bit/64Bit	<ul style="list-style-type: none">• At least 32MB of memory• At least 60MB of free space on the hard disk drive

Driver Installation

To install the latest version of the product driver, download it from the Samsung website.

(<http://www.samsung.com>)

- You can set the optimum resolution and frequency for this product by installing the corresponding drivers.

Chapter 06

Troubleshooting Guide

Requirements Before Contacting Samsung Customer Service Centre

— Before calling Samsung Customer Service Centre, test your product as follows. If the problem persists, contact Samsung Customer Service Centre.

Product diagnosis (Screen issue)

If a problem occurs with the product screen, run [Self Diagnosis](#) to check that the product is working properly.

Checking the Resolution and Frequency

If a resolution that is not supported (see the [Standard Signal Mode Table](#)) is selected, the **Not Optimum Mode** message may appear for a short time or the screen may not be displayed properly.

— The displayed resolution may vary, depending on the PC system settings and cables.

Check the following.

Caution

When the product makes popping (cracking) sound.

The sound may be caused by contraction or expansion from temperature change of external components or internal circuit of the product.

This is NOT a product failure and does not affect the life of the product.

Installation issue

Blank spaces are found on all four sides of the screen when an HDMI or HDMI-DVI cable is connected to the product and PC.

The blank spaces found on the screen have nothing to do with the product.

Blank spaces on the screen are caused by the PC or graphics card. To resolve the problem, adjust the screen size in the HDMI or DVI settings for the graphics card.

If the graphics card settings menu does not have an option to adjust the screen size, update the graphics card driver to the latest version.

(Please contact the graphics card or PC manufacturer for further details about how to adjust the screen settings.)

Screen issue

The power LED is off. The screen will not switch on.

Check that the power cable is connected properly.

If a problem occurs with the product screen, run [Self Diagnosis](#) to check that the product is working properly.

The message [Check the cable connection and the settings of the source device](#) appears.

Check that the cable is properly connected to the product.

Check that the device connected to the product is powered on.

Check the [PC/AV Mode](#) status. (□□□ → [System](#) → [PC/AV Mode](#) → [HDMI, Thunderbolt4/USB-C](#) → [PC](#) or [AV](#).)

Set the connected [HDMI](#) version. ([HDMI](#): □□□ → [System](#) → [Input Port Ver.](#) → 1.4)

[Not Optimum Mode](#) is displayed.

This message appears when the signal from the graphics card exceeds the maximum resolution or frequency for the product.

Change the maximum resolution and frequency to suit the product performance, referring to [Standard Signal Mode Table \(P.41\)](#).

The images on the screen look distorted.

Check the cable connection to the product.

The screen is not clear. The screen is blurry.

Remove any accessories (video extension cable, etc.) and try again.

Set the resolution and frequency to the recommended level.

The screen appears unstable and shaky. There are shadows or ghost images left on the screen.

Check that the resolution and frequency for the PC are within the range of resolution and frequency compatible with the product. Next, if required, change the settings, referring to [Standard Signal Mode Table \(P.41\)](#) in this manual and the [Information](#) menu on the product.

The screen is too bright. The screen is too dark.

Adjust [Brightness](#) and [Contrast](#).

Screen colour is inconsistent.

Change the [Color](#) settings.

The colours on the screen have a shadow and are distorted.

Change the [Color](#) settings.

White does not really look white.

Change the [Color](#) settings.

There is no image on the screen and the power LED blinks every 0.5 to 1 second.

Check the cable connection between the product and PC, and ensure the connectors are locked.

Press any key on the keyboard or move the mouse to return to normal operating mode.

The product is operating in power-saving mode.

When connecting an external device that exceeds the charging capacity of the Thunderbolt™ 4/USB-C port, charging or power supply may not work properly. For normal operation, be sure to connect the adapter dedicated to the device.

Text is blurry.

If using a Windows OS (e.g. Windows 7, Windows 8, Windows 8.1 or Windows 10): Go to [Control Panel](#) → [Fonts](#) → [Adjust ClearType text](#) and change [Turn on ClearType](#).

Video playback is choppy.

Playback of high-definition large video files can be choppy. This may be because the video player is not optimised for the PC resource.

Try playing the file on another video player.

Sound issue

There is no sound.

Re-check the condition of the connected headphone or earphone and/or adjust the volume.

Check the volume.

Check whether the volume of the product or the source device is set to mute.

The volume is too low.

Adjust the volume.

If the volume is still low after turning it up to the maximum level, adjust the volume on your PC sound card or software programme.

Video is available but there is no sound.

Sound cannot be heard if an HDMI-DVI cable or DVI cable is used to connect the input device.

Connect the device using an HDMI cable or a DP cable.

Source device issue

A beeping sound is heard when my PC is booting.

If a beeping sound is heard when your PC is booting, have your PC serviced.

Q & A

— Refer to the user manual for your PC or graphics card for further instructions on adjustment.

How can I change the frequency?

Set the frequency on your graphics card.

- Windows 7: Go to Control Panel → Appearance and Personalization → Display → Screen Resolution → Advanced settings → Monitor, and adjust Screen Refresh Rate under Monitor settings.
 - Windows 8(Windows 8.1): Go to Settings → Control Panel → Appearance and Personalization → Display → Screen Resolution → Advanced settings → Monitor, and adjust Refresh rate under Monitor settings.
 - Windows 10: Go to Settings → System → Display → Advanced display settings → Display adapter properties → Monitor, and adjust Screen refresh rate under Monitor settings.
-

How can I change the resolution?

- Windows 7: Go to Control Panel → Appearance and Personalization → Display → Screen Resolution → Adjust Resolution.
 - Windows 8(Windows 8.1): Go to Settings → Control Panel → Appearance and Personalization → Display → Adjust Resolution, and adjust the resolution.
 - Windows 10: Go to Settings → System → Display → Advanced display settings, and adjust the resolution.
-

How do I set power-saving mode?

- Windows 7: Go to Control Panel → Appearance and Personalization → Personalization → Screen Saver Settings → Power options or BIOS SETUP on the PC.
 - Windows 8(Windows 8.1): Go to Settings → Control Panel → Appearance and Personalization → Personalise → Screen Saver Settings → Power options or BIOS SETUP on the PC.
 - Windows 10: Go to Settings → Personalization → Lock screen → Screen timeout settings → Power & sleep or BIOS SETUP on the PC.
-

Chapter 07

Specifications

General

Model Name	S27B80*T
Size	27 Class (26.9 Inches / 68.4 cm)
Display area	596.736 mm (H) x 335.664 mm (V)
Pixel Pitch	0.1554 mm (H) x 0.1554 mm (V)
Maximum Pixel Clock	594 MHz
Power Supply	AC100-240V~ 50/60Hz Refer to the label at the back of the product as the standard voltage can vary in different countries.
Signal connectors	HDMI, Thunderbolt4/ USB-C
Environmental conditions	Operating Temperature: 10 °C to 40 °C (50 °F to 104 °F) Humidity: 10 % to 80 %, non-condensing Storage Temperature: -20 °C to 45 °C (-4 °F to 113 °F) Humidity: 5 % to 95 %, non-condensing

- Plug-and-Play
This product can be installed and used with any Plug-and-Play compatible systems. Two-way data exchange between the product and PC system optimises the product settings. Product installation takes place automatically. However, you can customise the installation settings if desired.
- Panel Dots (Pixels)
Due to the nature of the manufacturing of this product, approximately 1 pixel per million (1ppm) may be brighter or darker on the LCD panel. This does not affect product performance.
- The specifications are subject to change without notice to improve quality.
- For detailed device specifications, visit the Samsung website.
- (Europe only)
To access energy labelling information about this product on the European Product Registry for Energy Labelling (EPREL), go to https://eprel.ec.europa.eu/qr/***** where ***** is the product's EPREL registration number. You can find the registration number on the rating label of your product.
- (Türkiye only)
To access the energy labelling information of the model:
 - (1) Go to https://www.samsung.com/global/ecodesign_energy
 - (2) Get the model identifier from the energy label of the product and type it in the search box
 - (3) Energy labelling information can be found

Standard Signal Mode Table

Model Name	S27B80*T	
Synchronization	Horizontal Frequency	30 ~ 135 kHz
	Vertical Frequency	30 ~ 75 Hz
Resolution	Optimum Resolution	3840 x 2160 @ 60 Hz
	Maximum Resolution	

If a signal that belongs to the following standard signal modes is transmitted from your PC, the screen will automatically be adjusted. If the signal transmitted from the PC does not belong to the standard signal modes, the screen may be blank even though the power LED turns on. In such a case, change the settings according to the following table by referring to the graphics card user manual.

Resolution	Horizontal Frequency (kHz)	Vertical Frequency (Hz)	Pixel Clock (MHz)	Sync Polarity (H/V)	Port	
					HDMI IN	USB Type-C IN
VESA, 640 x 480	31.469	59.940	25.175	-/-	0	0
MAC, 640 x 480	35.000	66.667	30.240	-/-	0	0
VESA, 640 x 480	37.861	72.809	31.500	-/-	0	0
VESA, 640 x 480	37.500	75.000	31.500	-/-	0	0
IBM, 720 x 400	31.469	70.087	28.322	-/+	0	0
VESA, 800 x 600	35.156	56.250	36.000	+/+	0	0
VESA, 800 x 600	37.879	60.317	40.000	+/+	0	0
VESA, 800 x 600	48.077	72.188	50.000	+/+	0	0
VESA, 800 x 600	46.875	75.000	49.500	+/+	0	0
MAC, 832 x 624	49.726	74.551	57.284	-/-	0	0
VESA, 1024 x 768	48.363	60.004	65.000	-/-	0	0
VESA, 1024 x 768	56.476	70.069	75.000	-/-	0	0
VESA, 1024 x 768	60.023	75.029	78.750	+/+	0	0
VESA, 1152 x 864	67.500	75.000	108.000	+/+	0	0
MAC, 1152 x 870	68.681	75.062	100.000	-/-	0	0
VESA, 1280 x 720	45.000	60.000	74.250	+/+	0	0
VESA, 1280 x 800	49.702	59.810	83.500	-/+	0	0

Resolution	Horizontal Frequency (kHz)	Vertical Frequency (Hz)	Pixel Clock (MHz)	Sync Polarity (H/V)	Port	
					HDMI IN	USB Type-C IN
VESA, 1280 x 1024	63.981	60.020	108.000	+/+	0	0
VESA, 1280 x 1024	79.976	75.025	135.000	+/+	0	0
VESA, 1440 x 900	55.935	59.887	106.500	-/+	0	0
VESA, 1600 x 900	60.000	60.000	108.000	+/+	0	0
VESA, 1680 x 1050	65.290	59.954	146.250	-/+	0	0
VESA, 1920 x 1080	56.250	50.000	148.500	+/+	0	-
VESA, 1920 x 1080	67.500	60.000	148.500	+/+	0	0
VESA, 2560 x 1440	88.787	59.951	241.500	+/-	0	0
VESA, 3840 x 2160	67.500	30.000	297.000	+/+	0	0
VESA, 3840 x 2160	133.313	59.997	533.250	+/-	0	0

Horizontal Frequency

The time required to scan a single line from the left to the right side of the screen is called a horizontal cycle. The reciprocal number of a horizontal cycle is called horizontal frequency. Horizontal frequency is measured in kHz.

Vertical Frequency

Repeating the same picture dozens of times per second allows you to view natural pictures. The repeat frequency is called "vertical frequency" or "refresh rate" and is indicated in Hz.

This product can be set to only one resolution for each screen size to obtain the optimum picture quality due to the nature of the panel. Using a resolution other than the specified resolution may degrade the picture quality. To avoid this, it is recommended that you select the optimum resolution specified for your product.

Some resolutions listed in the table above may not be available depending on graphics card specifications.

Chapter 08

Appendix

Responsibility for the Pay Service (Cost to Customers)

— When the service is requested, in spite of in warranty, we may charge you for a visit from a service technician in the following cases.

Not a product defect

Cleaning of the product, Adjustment, Explanation, Re-installation and etc.

- If a service technician is requested to give instructions on how to use product or simply adjusts options without disassembling product.
- If a defect is caused by external environmental factors (Internet, Antenna, Wired Signal, etc.)
- If a product is reinstalled or devices are connected additionally after installing the purchased product for the first time.
- If a product is reinstalled to move to a different spot or to move to a different house.
- If the customer requests instructions on how to use another company's product.
- If customer requests instructions on how to use the network or another company's Programme.
- If customer requests software installation and setup for the product.
- If a service technician removes/cleans dusts or foreign materials inside of the product.
- If customer requests an installation additionally after purchasing a product through home-shopping or online.

A Product damage caused by customer's fault

Product damage caused by customer's mishandling or wrong repair

If a product damage is caused by;

- External impact or drop.
- Use of supplies or separately sold product unspecified by Samsung.
- Repair from a person besides an engineer of outsourcing service company or partner of Samsung Electronics Co., Ltd.
- Remodeling or repairing the product by customer.
- Using it with incorrect voltage or non-authorized electrical connections.
- Not following the "cautions" in User Manual.

Others

- If product fails by natural disaster. (lightning, fire, earthquake, flood damage, etc)
- If consumable components are all used up. (Battery, Toner, Fluorescent lights, Head, Vibrator, Lamp, Filter, Ribbon, etc.)

— If customer requests a service in case the product has no defect, service fee may be charged. So please read User Manual first.