

P27T-6 IPS

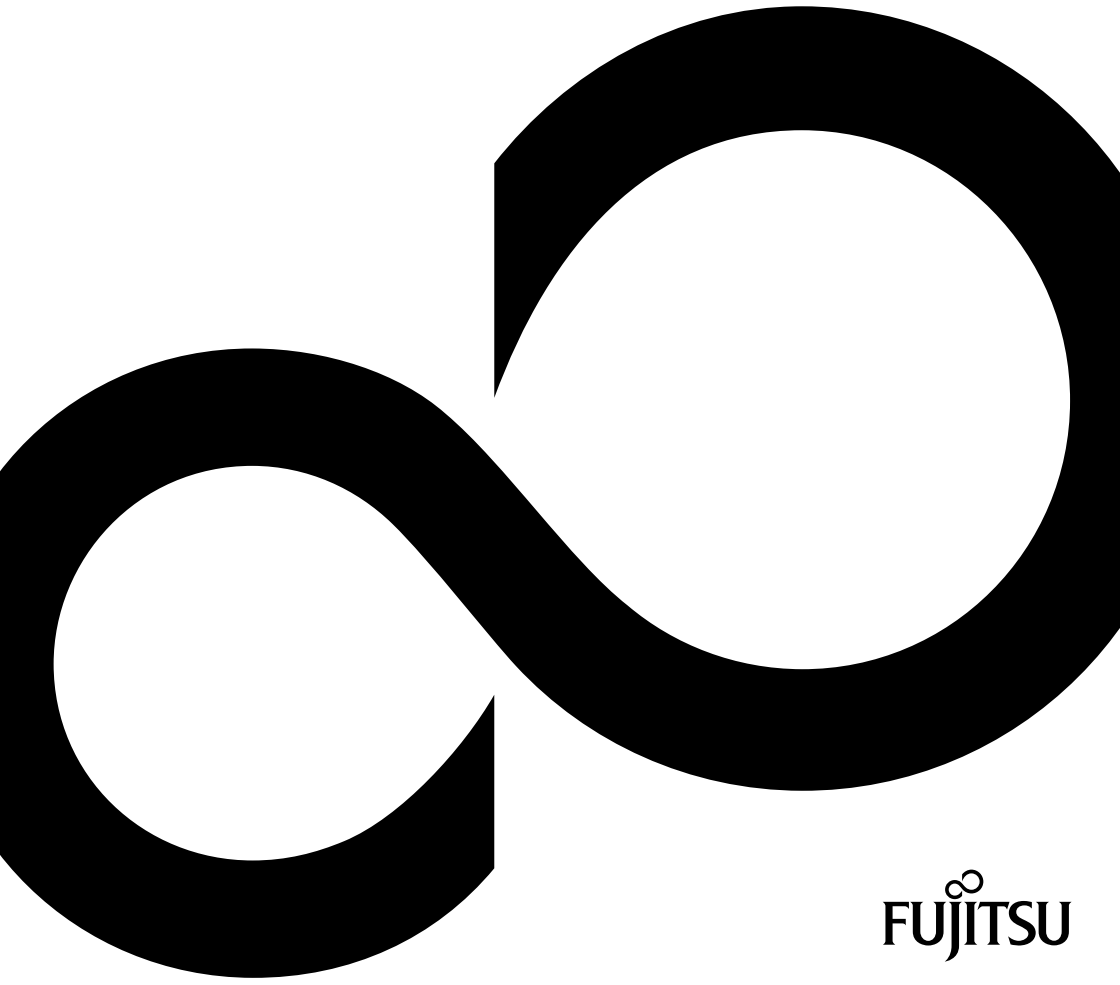

Congratulations, you have decided to buy an innovative Fujitsu product.

Latest information about our products, tips, updates etc. can be found on the Internet at: ["http://ts.fujitsu.com"](http://ts.fujitsu.com)

For automatic driver updates, go to: ["http://support.ts.fujitsu.com/support/index.html"](http://support.ts.fujitsu.com/support/index.html)

Should you have any technical questions, please contact:

- Our Hotline/Service Desk
(see the Service Desk list or visit: ["http://ts.fujitsu.com/support/servicedesk.html"](http://ts.fujitsu.com/support/servicedesk.html))
- Your authorized distributor
- Your sales office

We hope you really enjoy using your new Fujitsu system.



Copyright

Fujitsu Technology Solutions 10/09

Published by

Fujitsu Technology Solutions GmbH
Mies-van-der-Rohe-Straße 8
80807 Munich, Germany

Contact

<http://ts.fujitsu.com/support>

All rights reserved, including intellectual property rights. Subject to technical alterations. Delivery subject to availability. No warranty is offered or liability accepted in regard of the completeness, correctness, or current applicability of any data or illustrations. Brand names may be protected trademarks of the respective manufacturer and/or protected by copyright. Use of these by third parties for their own purposes may constitute an infringement of the holders' rights. Further information can be found at "http://ts.fujitsu.com/terms_of_use.html"

Order No. Fujitsu Technology Solutions GmbH: A26361-K1372-Z320-1-7619, edition 1

P27T-6 IPS

Operating Manual

Your LCD screen...	5
Important notes	7
Getting started	10
Operation	17
Notes on ergonomic colour adjustment	28
Troubleshooting	29
Explanatory information about standard ISO 9241-307	31
Technical specification	32

Windows 7, Windows Vista and Windows XP are registered trademarks of Microsoft Corporation.

VESA, DDC and DPMS are registered trademarks of Video Electronics Standards Association.

All other trademarks used in this document are trademarks or registered trademarks of their respective owners and are recognised as being protected.

Copyright © Fujitsu Technology Solutions GmbH 2010

All rights reserved, including rights of translation, reproduction by printing, copying or similar methods, either in part or in whole.

Offenders will be liable to prosecution and payment of damages.

All rights reserved, including rights created by patent grant or registration of a utility model or design.

Delivery subject to availability. Subject to technical alterations.

Contents

Your LCD screen...	5
Target group	5
Further information	6
Notational conventions	6
Important notes	7
Safety instructions	7
Power cable	8
Transporting the device	8
Cleaning the device	8
CE marking	9
Power management	9
Disposal and recycling	9
Getting started	10
Unpacking and checking the delivery	10
Setting up the device	10
Setting up an ergonomic video workstation	11
Adjusting height	13
Adjusting the inclination	13
Removing monitor base	14
Connecting the device	15
Connecting cables to the computer	16
Operation	17
Switching the device on and off	17
Notes on power management	18
Changing the monitor settings	19
Changing the monitor settings with the buttons of the control panel	19
Changing the monitor settings using the OSD menu	22
Notes on ergonomic colour adjustment	28
Troubleshooting	29
Explanatory information about standard ISO 9241-307	31
Technical specification	32
VESA-DDC-compatible VGA interface	33
Preset operating modes	33
Most frequent operating modes	33
Video/TV operating modes using DP and HDMI	34
SUB D port	34
DVI-D port	35
DisplayPort socket	36
HDMI port	37

Your LCD screen...

has a whole range of useful features and functions, e.g.:

- TFT display (Thin Film Transistor; active matrix)
- minimal space requirements thanks to slim casing
- optimum ergonomic characteristics (totally distortion-free, excellent picture definition and colour purity right into the corners)
- high degree of brightness and good contrast
- high resolution (1920 x 1080) via VGA and HDMI
- high resolution (2560 x 1440) via DVI and Display Port
- presentation of up to 16.7 million colours (in conjunction with an appropriate display adapter)
- automatic scanning of horizontal frequencies from 30 to 82 kHz and refresh rates (vertical frequencies) from 56 to 76 Hz (absolutely flicker-free)
- digital screen controller with microprocessor for storing 36 different display modes
- freely adjustable colour alignment for matching the screen colours to the colours of various input and output devices
- convenient operation via integrated OSD (On-Screen-display) menu
- VESA-DDC compatibility
- VESA-FPMPI compatibility (Flat Panel Monitor Physical Mounting Interface) – Mounting device for swivel arm and wall bracket
- Plug&Play capability
- Digital video inputs (DVI, HDMI and Display Port DP) with HDCP
- power management for reducing power consumption when the computer is not in use
- Compliance with the recommendations according to TCO '03
- the monitor fulfills all GS ("Geprüfte Sicherheit", Certified Security) requirements.

This operating manual contains important information you require to start up and run your LCD monitor.

A graphics card (display adapter) with VGA interface or a digital display adapter with DVI interface or video signal source with DP interface is required to control the LCD monitor. The monitor processes the data supplied to it by the display adapter. The display adapter or the associated driver software is responsible for setting the modes (resolution and refresh rate).

When putting the monitor into operation for the first time, the screen display should be optimally adapted to the display adapter used and adjusted in accordance with your needs (see chapter ["Changing the monitor settings", Page 19](#)).

Target group

You don't need to be an "expert" to perform the operations described here. Nonetheless, it is important to always observe the safety notes given in the operating instructions for the computer and in this manual.

In the event of any problems, please contact your sales office or our Service Desk.







Further information

Details of how you set the resolution and refresh rate are provided in the documentation for your display adapter and the associated driver software.

For ergonomic reasons, use of the Dual-Link DVI or DP data cable and a screen resolution of 2560 x 1440 pixels are recommended.

Because of the technology used (active matrix) an LCD monitor provides a totally flicker-free picture even with a refresh rate of 60 Hz.

Notational conventions

	Pay particular attention to text marked with this symbol. Failure to observe these warnings could pose a risk to health, damage the device or lead to loss of data. The warranty will be invalidated if the device becomes defective through failure to observe these warnings.
	Indicates important information for the proper use of the device.
	Indicates an activity that must be performed
	Indicates a result
This font	indicates data entered using the keyboard in a program dialogue or at the command line, e.g. your password (Name123) or a command used to start a program (start.exe)
This font	indicates information that is displayed on the screen by a program, e.g.: Installation is complete.
<i>This font</i>	indicates <ul style="list-style-type: none"> • terms and texts used in a software interface, e.g.: Click on <i>Save</i> • names of programs or files, e.g. <i>Windows</i> or <i>setup.exe</i>.
"This font"	indicates <ul style="list-style-type: none"> • cross-references to another section, e.g. "Safety information" • cross-references to an external source, e.g. a web address: For more information, go to "http://ts.fujitsu.com" • Names of CDs, DVDs and titles or designations of other materials, e.g.: "CD/DVD Drivers & Utilities" or "Safety" Manual
	indicates a button on the monitor, e.g.: 
This font	indicates terms and texts that are emphasised or highlighted, e.g.: Do not switch off the device

Important notes

In this chapter you will find information regarding safety which it is essential to take note of when working with your device.

Safety instructions

This device complies with the relevant safety regulations for data processing equipment, including electronic office machines for use in an office environment. If you have any questions about whether the device can be used in the intended environment, please contact your sales office or our Service Desk.

- The display surface of the device is sensitive to pressure and scratches. You should therefore be careful with the display surface in order to avoid lasting damage (scratches).
- If the device is brought into the installation site from a cold environment, condensation can form. Before operating the device, wait until it is absolutely dry and has reached approximately the same temperature as the installation site.
- When installing and operating the device, please observe the notes on environmental conditions in Chapter ["Technical specification", Page 32](#) as well as the instructions in Chapter ["Setting up an ergonomic video workstation", Page 11](#).
- To ensure sufficient ventilation, the air inlet and outlet openings of the device must be kept clear.
- The device automatically sets itself to the correct voltage within the range from 100 V to 240 V. Make sure that the local mains voltage is neither higher nor lower than this range.
- Ensure that the power socket on the device and the mains outlet are freely accessible.
- The ON/OFF switch does not disconnect the monitor from the mains voltage. To disconnect fully from the mains supply, disconnect the power plug from the socket.
- The device is equipped with a power cable that complies with safety standards.
- Use the supplied power cable only.
- Lay the cables in such a way that they do not create a hazard (danger of tripping) and cannot be damaged. When connecting the device, observe the relevant notes in chapter ["Connecting the device", Page 15](#).
- No data transfer cables should be connected or disconnected during a thunderstorm.
- Make sure that no objects (e.g. jewellery chains, paper clips, etc.) or liquids get inside the device (danger of electric shock, short circuit).
- The device is not waterproof! Never immerse the device in water and protect it from spray water (rain, sea water).
- In an emergency (e.g. damaged casing, operation controls or cables, penetration of liquids or foreign matter), switch off the device, disconnect the power plug and contact your sales outlet or our Service Desk.
- Repairs to the device must only be performed by qualified technicians. Unauthorised opening and incorrect repair may greatly endanger the user (electric shock, fire risk).
- Only use the screen resolution settings and refresh rates specified in Chapter ["Technical specification", Page 32](#). Otherwise you may damage the device. If you are in any doubt, contact your sales outlet or our Help Desk.
- Use a screen saver with moving images and activate the power management for your monitor to prevent still images from "burning in".
- If you operate the device with the swivel arm or wall bracket, it must not be turned by 180°.

- The device must only be operated in landscape mode (0°) and portrait mode (90°). The control buttons are located in the middle of the bottom of the monitor in landscape mode (0°) and at the left-hand side of the monitor in portrait mode (90°).
- Store this manual close to the device. If you pass the device on to third parties, you should pass this manual on with it.
- We recommend that you place your device on a durable, non-slip surface. In view of the many different finishes and varnishes used on furniture, it is possible that the feet of the device may mark the surface they stand on.
- To ensure sufficient ventilation, the air supply and air outlet openings of the monitor must never be blocked.

Power cable

Use the supplied power cable only.

Use the following guidelines if it is necessary to replace the original cable set.

- The female/male receptacles of the cord set must meet IEC60320/CEE-22 requirements.
- The cable has to be HAR-certified or VDE-certified. The mark HAR or VDE will appear on the outer sheath.
- For devices which are mounted on a desk or table, type SVT or SJT cable sets may be used. For devices which sit on the floor, only SJT type cable sets may be used.
- The cable set must be selected according to the rated current for your device.
- If necessary, replace the original power cable with a regular grounded 3-core mains lead.

Transporting the device



Transport all parts separately in their original packaging or in a packaging which protects them from knocks and jolts, to the new site.

Do not unpack them until all transportation manoeuvres are completed.

If the device is brought from a cold environment into the room where it will be used, condensation may occur. Before operating the device, wait until it is absolutely dry and has reached approximately the same temperature as the installation site.

Cleaning the device



Switch off the device and unplug the power plug.

Do not clean any interior parts yourself, leave this job to a service technician.

Do not use any cleaning agents that contain abrasives or may corrode plastic.

Ensure that no liquid enters the device.

The display surface of the device is sensitive to pressure and scratches. Clean it only using a soft, slightly moistened cloth.

The surface of the casing can be cleaned with a dry cloth. If particularly dirty, use a cloth that has been moistened in mild domestic detergent and then carefully wrung out.

CE marking



The shipped version of this device complies with the requirements of EEC directives 2004/108/EC "Electromagnetic compatibility" and 2006/95/EC "Low voltage directive".

Power management

The Fujitsu LCD monitor is equipped with power management which, when in 0W power saving mode, reduces the power consumption to 0W (for VGA and DVI).

Disposal and recycling

This device has been manufactured as far as possible from materials which can be recycled or disposed of in such a way that the environment is not damaged. The device may be taken back after use to be reused or recycled, provided that it is returned in a condition that benefits its intended use. Any components not reclaimed will be disposed of in an environmentally acceptable manner.

The device must be disposed of in accordance with the local regulations for disposal of special waste.

If you have any questions on disposal, please contact your local sales office or our Service Desk, or contact one of the following directly:

Germany	Belgium	Switzerland
Fujitsu Technology Solutions GmbH Remarketing and Recycling D-33106 Paderborn Tel.: +49 5251 / 81 80 10 Fax: +49 5251 / 81 80 15 "http://ts.fujitsu.com/wvm"	RECUPEL Boulevard Reyers, 80 B-1030 Brussels Tel.: +32 2 / 706 86 16 Fax: +32 2 / 706 86 13 E-Mail: info@recupel.be "http://www.recupel.be"	SWICO Schweizerischer Wirtschaftsverband der Informations-, Kommunikations- und Organisationstechnik A list of the SWICO acceptance places can be found at: "http://www.swico.ch"
Asia	USA	
Taiwan: Environmental Protection Administration Executive Yuan R.O.C. "http://recycle.epa.gov.tw"	Fujitsu America, Inc. 1250E. Arques Avenue Sunnyvale, CA 94085 U.S.A. Contact: Henning, Bernd Phone No.: (408) 329-6737 Fax No.: (408) 746-8299	

Information on this subject is also available on the Internet at ["http://ts.fujitsu.com/recycling"](http://ts.fujitsu.com/recycling).

Getting started

Unpacking and checking the delivery



The display surface of the device is sensitive to pressure and scratches. Always hold the device by the casing!

The complete device package includes:

- one monitor
- one data cable (DP)
- one data cable (DVI Dual Link)
- one USB cable
- one audio cable
- one power cable
- one CD with software and documentation
- one Warranty Booklet
- one "Quick Start Guide" brochure
- one "Safety" manual

- ▶ Unpack all the individual parts.
- ▶ Check the contents of the package for any visible damage caused during transport.
- ▶ Check whether the delivery conforms to the details in the delivery note.
- ▶ Should you discover that the delivery does not correspond to the delivery note, notify your local sales outlet immediately.



Do not discard the original packing material of the devices. You may need the packaging in the future if you need to transport your device.

Setting up the device



To ensure sufficient ventilation, the air inlet and outlet openings of the device must be kept clear.

Setting up an ergonomic video workstation

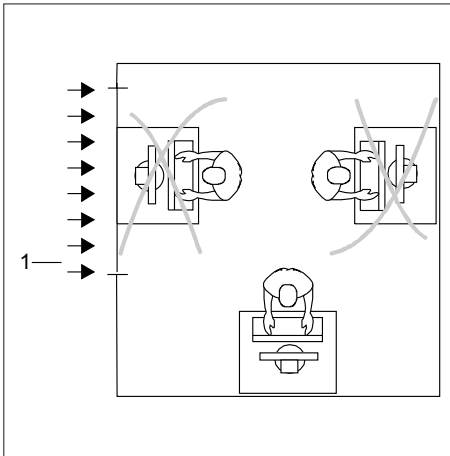

- ▶ Do not position the video workstation opposite a window (1).

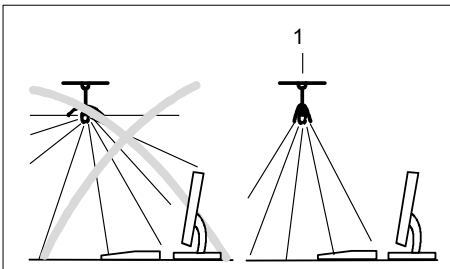

- ▶ Position the monitor outside the reach of a light source (1).



- ▶ Position the keyboard where it is easiest to reach (1).

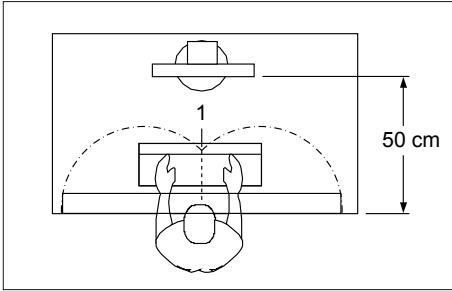

- Position the monitor so that the eye distance to the screen (1) is around 50 cm.

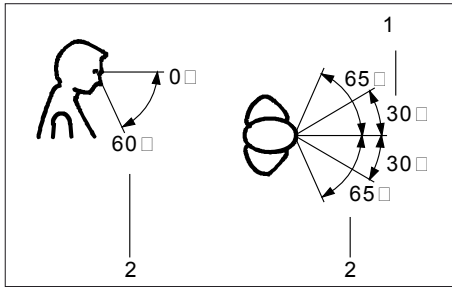

- Position the monitor for optimum viewing (1). The monitor should under no circumstances fall outside the permissible viewing space (2).



Depending on the situation, it may be advisable to use a swivel arm or wall bracket (VESA FPMPMI), which are available from specialist dealers. For this purpose the monitor base must be removed beforehand as described in Chapter ["Removing monitor base"](#), Page 14.

Adjusting height



The height adjustment is fixed in the transport position.

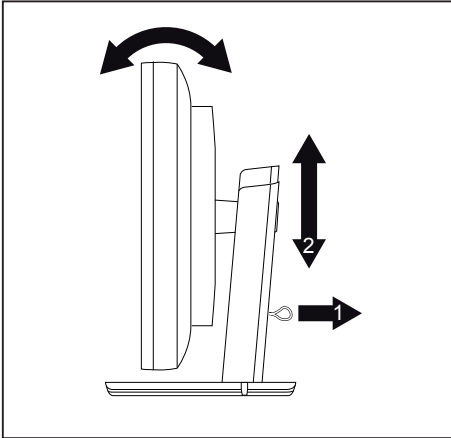

- ▶ To free the fixing, remove the locking pin on the flange (1).
- ↳ The height of the monitor can be adjusted by approximately 120 mm.
- ▶ Grasp the monitor with both hands on the right and left edge of the casing and move it up or down (2).

Adjusting the inclination

The inclination of the monitor can be adjusted by -5° (forward) and $+25^\circ$ (back) from its vertical position.

- ▶ Hold the monitor with both hands on the left and right sides of the casing and move it to the desired angle.

Removing monitor base

Before you can use a swivel arm or a wall bracket, you must remove the monitor base.



The display surface is susceptible to scratching!

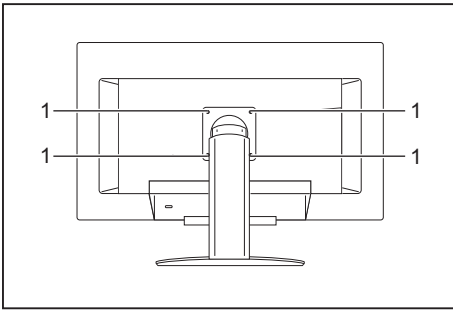

- ▶ Switch off the monitor and pull the power plug out of the power socket.
- ▶ Lay the monitor on its face on a soft surface.
- ▶ Remove the cover and disconnect all cables.
- ▶ Remove the screws (1) on the rear of the monitor.
- ↳ You can now mount a swivel arm or a wall bracket in accordance with VESA FPMPMI using a hole spacing of 100 mm.



For instructions on how to mount the swivel arm or wall bracket, please see the documentation for the swivel arm or wall bracket.

Connecting the device



Please observe the safety information in ["Important notes", Page 7.](#)

CE conformance and optimum picture quality are guaranteed only if you use the data cables supplied.

- ▶ Switch off the monitor and the computer.
- ▶ Disconnect the power plug from the computer.

Connecting cables to the monitor

The monitor ports are protected by a cover.

The supplied data cables have two 15-pin D-SUB connectors or two 24-pin DVI connectors or two 20-pin DP-connectors for connection to the monitor and to the computer.

Information on the computer connections and interfaces is contained in the operating manual for the computer.

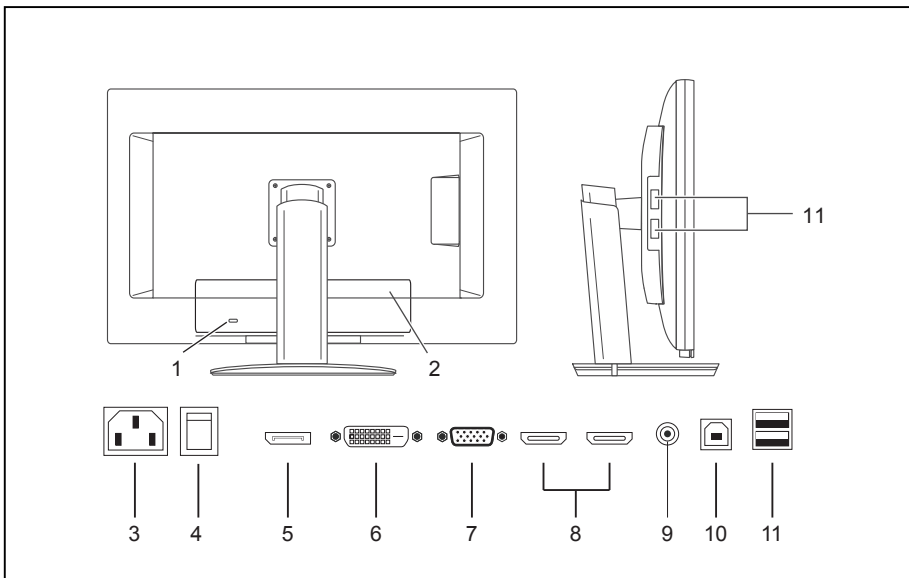

1 = Security slot for "Kensington Lock"

2 = Cover

3 = Power connector

4 = 0 W switch

5 = DP connector

6 = DVI-D socket (DVI)

7 = D-SUB socket (VGA)

8 = HDMI sockets

9 = AUDIO-IN socket

10 = USB IN (Downstream)

11 = USB OUT (Upstream)

- ▶ Remove the cover.

- ▶ Select the appropriate data cable for your computer.
- ▶ Connect one of the connectors of the data cable to the DVI-D socket or the DP socket of the monitor and secure the DVI-D connection by tightening the safety screws.



If you use a DP or HDMI data cable, you must set the 0 W switch to the basic position. If you use a VGA or DVI Dual Link data cable, when the PC is switched off you can move the 0 W switch to the ECO position to enable the 0 W power saving mode.

The monitor automatically detects the input (VGA, DVI, DP) when only one signal source is connected.

An HDMI input must always be selected manually. The change from HDMI to VGA, DVI, DP or the 2nd HDMI input can also only be done manually.

- ▶ Insert one connector of the audio line in the AUDIO IN (9) socket on the monitor and make sure it is properly engaged.
- ▶ Plug the power cable supplied into the power connector of the monitor.
- ▶ Plug the supplied USB cable into the USB IN socket (10) and the other end of the cable into a USB socket of the computer.



Connect the USB keyboard and USB mouse directly to the PC, as the USB connector socket of the monitor is switched off in energy-saving mode.

- ▶ Secure the cover over the connections.



A lock (Kensington Lock) can be mounted in the security slot to protect the monitor against theft. A Kensington lock is not supplied with the monitor.

Connecting cables to the computer

Information on the computer connections and interfaces is contained in the operating manual for your computer.

- ▶ Connect the data cable to the (active) monitor port on the computer and secure the plug-in connection by tightening the safety screws.
- ▶ Insert the other plug of the audio cable in the audio output of the computer.
- ▶ Plug the power connector of the monitor into a properly grounded mains outlet.
- ▶ Plug the power connector of the computer into a properly grounded mains outlet.



If your computer has two monitor ports ("onboard" screen controller and separate graphics card), the monitor port for the separate graphics card is active as standard.

Operation

Switching the device on and off

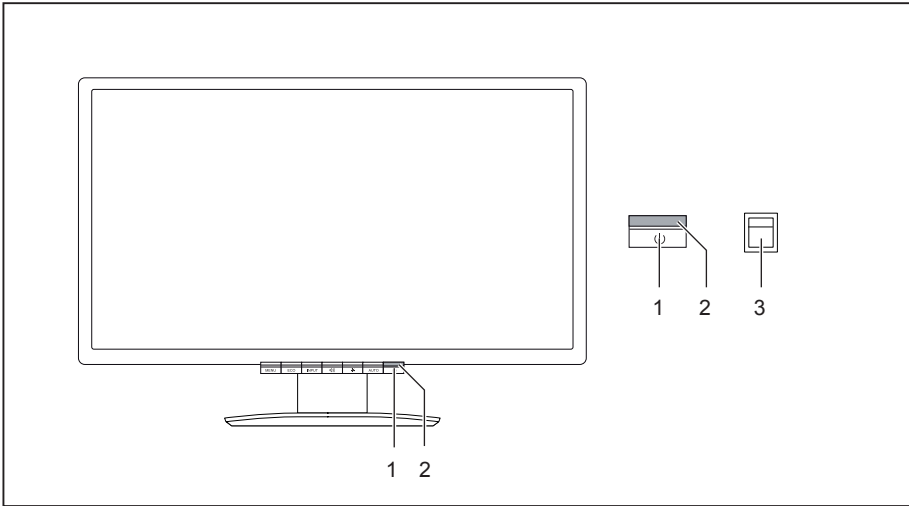

1 = Switch On/Off

3 = 0 W switch

2 = Power supply indicator

The colour of the LED indicator changes as follows:

LED indicator	Status
blue	Monitor and computer are switched on (normal mode).
green	Monitor and computer are switched on (ECO mode).
orange	Monitor is not receiving a video signal or is in BASIC power saving mode.
does not light up	Monitor is switched off (or is in 0W power-saving mode).



The "0" position of the 0 W switch (3) on the rear activates ECO power saving mode (0 W operating mode), the "I" position switches to the BASIC power saving mode <1 W. This setting is needed for the HDMI and DP data cables, but may also become necessary for VGA or DVI on some PCs if the monitor remains dark in the 0 W operating mode.

- Switch the device on again with the ON/OFF switch (1).

Notes on power management

If your computer is equipped with power management (power saving mode), the monitor can fully support this function. The monitor thereby distinguishes between the individual power saving modes of the computer (standby mode, suspend mode and OFF mode).

Stage	Operation		Power-saving mode (0 W switch)	
	Normal	ECO	ECO (0)	BASIC (I)
Power supply indicator	Lights up blue	Lit green	is unlit	illuminated orange
Display	Max. brightness	typ. 200 cd/m ²	unlit	orange
Typical power consumption (without USB and audio)	126 W	< 85 W	reduced to 0 W (only for VGA, DVI)	reduced to < 1 W (VGA/DVI/DP) reduced to < 2 W (HDMI)

If the computer detects inactivity (no input) it sends an appropriate signal to the monitor to reduce the power consumption (power saving mode). The power indicator of the monitor changes colour to show the change in status. The ECO operating mode and BASIC power-saving mode are the preset factory defaults.

Once an input is made at the computer the screen contents are restored.



For detailed information on how energy-saving mode operates, please refer to the operating manual or technical manual of the computer.

Changing the monitor settings

When putting the monitor into operation for the first time, the screen display should be optimally adapted to the display adapter used.

Changing the monitor settings with the buttons of the control panel

i

The buttons of the control panel have two functions. If the OSD menu is activated, a description of the current function of the buttons is displayed directly above the buttons at the edge of the screen. If the OSD menu is not activated, you can make the following settings directly:

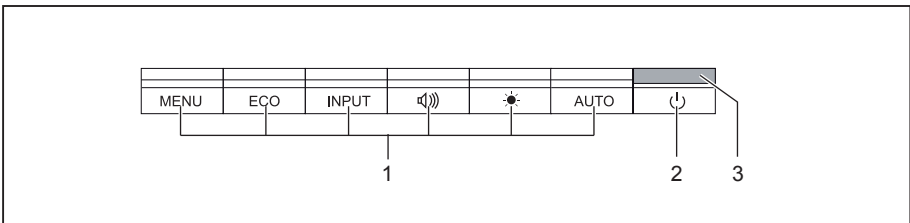

1 = Buttons for the OSD menu (On Screen Display)

3 = Power supply indicator

2 = ON/OFF switch

Select OSD language

If one of the buttons is being pressed for the first time for the OSD menu, the selection screen for the language is displayed:

- ▶ Press the **ECO** / Δ or the **INPUT** / ∇ button to select the required language.
- ▶ Press the **MENU** / \checkmark button to confirm your entries or the **AUTO** / \times button to cancel the process.

i

After selecting the OSD language for the first time, you can change it at any time in the OSD.

Performing auto-adjustment of the monitor

- ▶ Press the **AUTO** / \times button for about 1 second.
- ↳ The *Auto Processing* message appears
Picture quality and position are set to optimum values for your system.

Selecting input signal (D-SUB/DVI-D/HDMI)

- ▶ Press the **INPUT** / ▽ button to call up the *Input select* settings window.
- ▶ Press the **ECO** / △ or the **INPUT** / ▽ button to select the desired monitor connection (VGA, DVI or DP).
- ▶ Press the **MENU** / ✓ button to confirm your selection or the **AUTO** / ✕ button to cancel the process.



This setting window can also be called up when the OSD menu is locked.

Locking the OSD menu

The OSD menu can be locked to prevent accidental or unauthorised changes to the monitor settings.

- ▶ Press and hold the **MENU** / ✓ button for a few seconds while you switch on the monitor using the ON/OFF switch.
- ↳ The message *OSD locked / unlocked* is displayed.



Please proceed in the same manner to release the locked OSD menu again.

Activate/deactivate ECO operating mode



The power consumption of the device can be decreased by reducing the brightness of the picture.

- ▶ Press the **ECO** / △ button to switch the ECO operating mode on or off.
- ↳ The message *ECO Mode ein* or *ECO Mode off* appears.

If the ECO operating mode is activated, the following OSD settings are changed:

<i>Mode</i>	Office
<i>Colour</i>	6,500 K
<i>Brightness</i>	reduced

After the ECO operating mode is switched off, the brightness previously set by the user is restored.

Locking the ON/OFF button

The ON/OFF switch can be locked to prevent accidental or unauthorised changes to the monitor settings.

▶ Press and hold the **ECO** / \triangle and **INPUT** / ∇ buttons at the same time for a few seconds.

↳ The message *Power button locked / unlocked* is displayed.



Proceed in the same way to release the locked ON/OFF switch again.

Changing the monitor settings using the OSD menu

With the buttons on the control panel, you can call up and use the integrated OSD (On-Screen Display) menu.



The English menu names are used in the following description (default setting).

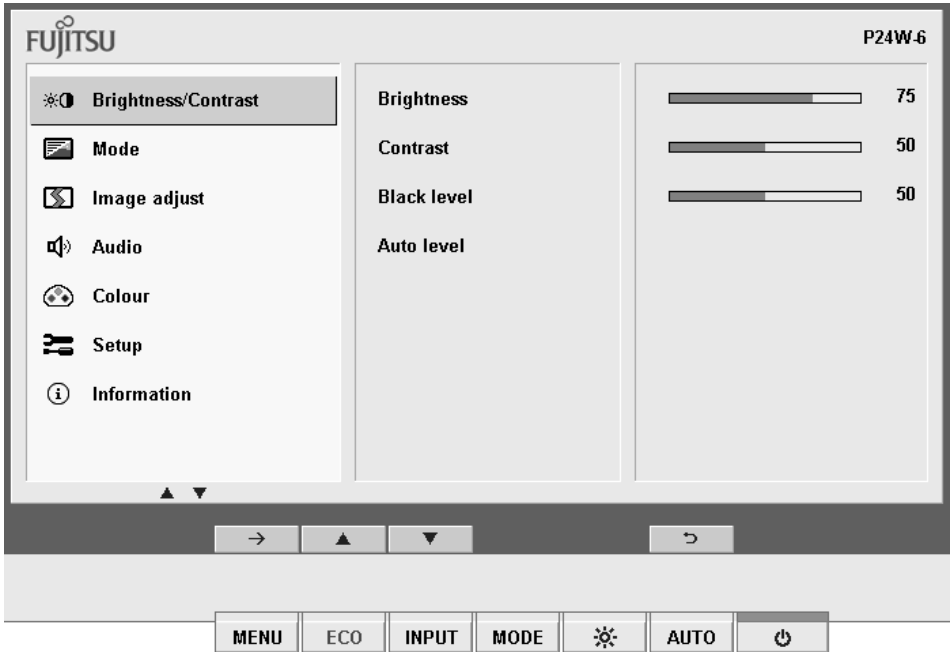

- ▶ Press the **MENU** / → button to activate the OSD menu.
- ↳ The main menu appears, with icons for the setting functions.
The first symbol, (*Brightness/Contrast*), is highlighted and the associated functions are visible in the right-hand menu field.
- ▶ Press the **ECO** / ∇ or the **INPUT** / △ button to highlight another icon (e.g. *Image adjust*).
- ▶ Press the **MENU** / → button to select the highlighted icon.
- ↳ The *Image adjust* settings window is displayed.
- ▶ Press the **AUTO** / ↻ button to exit the main menu.

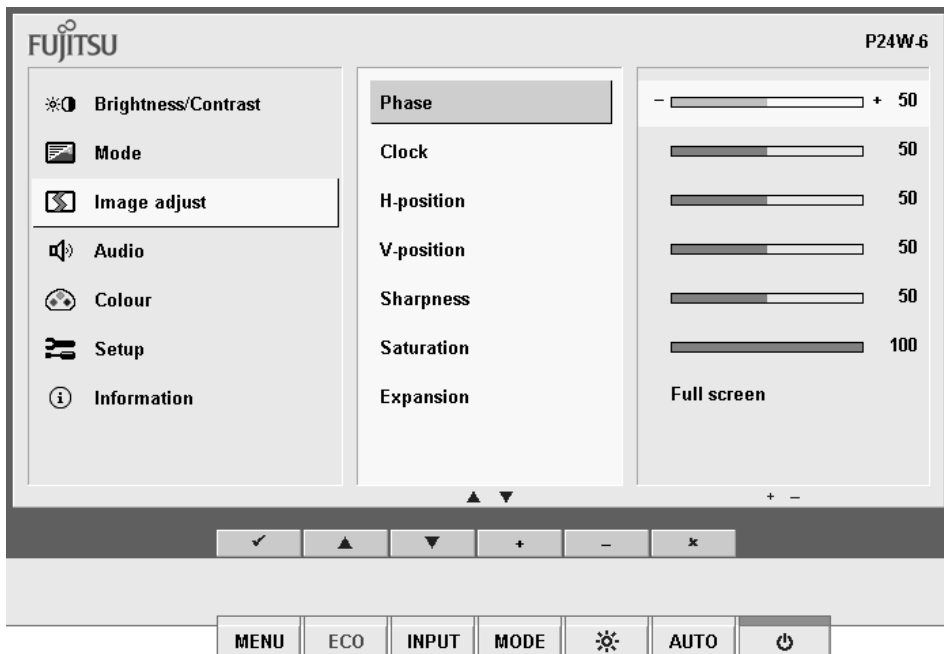

- ▶ Press the **ECO** / ▽ or **INPUT** / △ button to highlight another function.
- ▶ Press the **MODE** / + button or the ☀ / - button to change the setting.
- ▶ Press the **ECO** / ▽ or the **INPUT** / △ button to highlight another function.
- ▶ Press the **MENU** / ✓ button to save the change or press the **AUTO** / ✕ button to exit the function without making any changes.





If you want to change other settings, select the corresponding function from the OSD main menu. All possible adjustments of the main menu are described in the following.

OSD menu functions



The OSD menu for analogue monitor operation is described below. During digital operation some functions are not available, they are not needed because of the digital transmission technology being used.

Adjusting the brightness and contrast

	Call up the <i>Brightness/Contrast</i> setting window
<i>Brightness</i>	Set the brightness of the display With this function you change the brightness of the background lighting.
<i>Contrast</i>	Set the contrast of the display With this function you modify the contrast of bright colour tones.
<i>Black level</i>	Set the brightness of the display With this function you modify the contrast of dark colour tones.
<i>Auto Brightness</i>	Automatic brightness control This function is used to automatically control the brightness of the background lighting using the light sensor. <i>On</i> = The brightness is adjusted according to the ambient brightness <i>Off</i> = The brightness is adjusted manually by the user
<i>Auto level</i>	Adjust the signal level With this function you can automatically set the contrast. The function is executed with the  button.



If the contrast is set too high, bright surfaces can no longer be distinguished from very bright surfaces. If the contrast is set too low, the maximum brightness will not be achieved.

Selecting the application mode

	Call up the <i>Mode</i> setting window
<i>D mode</i>	Setting for DICOM simulation (the values for colour and ACR are locked: Colour = 7500K, ACR = off)
<i>Office</i>	Office presets (the settings for <i>colour</i> and <i>sharpness</i> can be adjusted)
<i>Photo</i>	Photo presets (<i>colour</i> , <i>sharpness</i> , <i>saturation</i> , <i>ACR</i>)
<i>Video</i>	Video presets (<i>colour</i> , <i>sharpness</i> , <i>saturation</i> , <i>ACR</i>)



ACR = Dynamic contrast (on / off)

Adjusting the picture size and position

	Call the <i>Image adjust</i> setting window
<i>Phase</i>	Eliminate picture disturbance With this function you fine-tune your monitor to eliminate picture disturbance.
<i>Clock</i>	Set synchronisation With this function you adjust the picture width to eliminate vertical picture disturbances.
<i>H-Position</i>	Adjust the horizontal position With this function you move the picture to the left or to the right.
<i>V-Position</i>	Adjust the vertical position With this function you move the picture up or down.
<i>Sharpness</i>	Adjust the sharpness of the picture for the <i>Photo</i> and <i>Video</i> modes.
<i>Saturation</i>	Adjust the saturation for the <i>Photo</i> and <i>Video</i> modes.
<i>Expansion</i>	Adjust the picture size <i>Full screen</i> = selection of full screen mode <i>Keep aspect</i> = maximum picture size without distortion (only for PC image)

Adjusting the volume

	Call the <i>Audio</i> setting window
<i>Volume</i>	Set the volume for playback with the integrated loudspeakers
<i>Mute</i>	Switch the loudspeakers off or on

Setting colour temperature and colours

	<p>Call the <i>Colour</i> setting window</p>
	<p>Select the colour temperature</p> <p>The "warmth" of the screen colours is set using the colour temperature. The colour temperature is measured in Kelvin (K). You can choose between <i>sRGB</i>, <i>6500 K</i>, <i>7500 K</i>, <i>9300 K</i>, <i>AdobeRGB</i>, <i>Native</i> and <i>Custom Colour</i>.</p> <p>The options <i>sRGB</i>, <i>AdobeRGB</i>, <i>Native</i> and <i>Custom colour</i> are only available in <i>Office</i> mode setting.</p> <p>In the user-defined setting you can change the colour ratios of the basic colours (red, green, blue) as required.</p> <p>The <i>6500K</i> and <i>sRGB</i> settings are recommended for general Windows applications.</p> <p>The <i>AdobeRGB</i> setting is for applications in the enhanced <i>AdobeRGB</i> colour space.</p> <p>The full colour space of the LCD panel can be used in the <i>Native</i> and <i>Custom Colour</i> settings.</p>

Setting functions

	<p>Call up the <i>Setup</i> settings window</p>
<p><i>Input select</i></p>	<p>Select the input signal</p> <p>This function is used to select the input signal (VGA, DVI, DP, HDMI1 or HDMI2).</p> <p>This is on condition that the display adapter supports this function.</p>
<p><i>Language</i></p>	<p>Set the language for the OSD menu</p> <p>With this function you select the language for the OSD menu.</p> <p>The default setting is English.</p>
<p><i>DDC-CI</i></p>	<p>Activates/deactivates the DDC-CI function</p> <p><i>On</i> = The DDC-CI function is activated (default setting)</p> <p><i>Off</i> = The DDC-CI function is deactivated</p>
<p><i>OSDTimeout</i></p>	<p>Set the display duration of the OSD menu</p> <p>With this function you select a value from 10 to 120 seconds.</p> <p>If the set time expires without a setting being made, the OSD menu is automatically faded out.</p>
<p><i>Factory recall</i></p>	<p>Activate the factory settings</p> <p>With this function all settings are reset to the factory settings without prompting for confirmation.</p> <p>The function is executed with the * button. If you are using a VGA data cable, an <i>Auto Processing</i> message is displayed. The language selection menu appears.</p>

Displaying information

	<p>Call the <i>Information</i> setting window</p> <p>With this function the model designation, serial number, resolution, H/V frequency, input signal, colour setting and polarity of the synchronisation signal are displayed.</p>
--	---

Notes on ergonomic colour adjustment



If you select colours for the monitor in your application programmes, take note of the information below.

The primary colours blue and red on a dark background do not produce the minimum required contrast of 3:1 and are therefore not suitable for continuous text and data entry.

When using several colours for characters and background and giving the primary colours full modulation, you can obtain very suitable colour combinations (see the following table):

Background	Characters							
	black	white	purple	blue	cyan	green	yellow	red
black		+	+	-	+	+	+	-
white	+		+	+	-	-	-	+
purple	+	+		-	-	-	-	-
blue	-	+	-		+	-	+	-
cyan	+	-	-	+		-	-	-
green	+	-	-	+	-		-	-
yellow	+	-	+	+	-	-		+
red	-	+	-	-	-	-	+	

+ Colour combination very suitable

- Colour combination not suitable because colour hues are too close together, thin characters are not identifiable or rigorous focusing is demanded of the human eye.

Troubleshooting

Should an error occur, first check the following points. If the distortion is still not eliminated, the monitor should, if possible, be checked on another computer.

If you cannot solve the problem, please contact our Service Desk.

Having this problem?	Check the following points:
No screen display Power indicator does not light up	<ul style="list-style-type: none"> ▶ Test whether changing the 0 W switch on the rear to the " 1 " position cures the problem. ▶ Check whether the power cable on the monitor is connected correctly. ▶ Check whether the computer is switched on.
No screen display LEDs not lit	<ul style="list-style-type: none"> ▶ Check whether you are using a DP or HDMI data cable and whether the 0 W switch is set to "I".
No screen display Power indicator is lit	<ul style="list-style-type: none"> ▶ Check whether the computer is switched on. ▶ Check whether the data cable for the monitor is correctly attached to the monitor port on the computer. ▶ Press any key on the computer keyboard. The computer may be in power saving mode. ▶ Alter the brightness and/or contrast until you get a picture.
Message: No Signal	<ul style="list-style-type: none"> ▶ Check whether the data cable for the monitor is correctly attached to the monitor port on the computer. ▶ Check whether the computer is switched on.
Message: Frequency out of range:## kHz / ## Hz Please change the display mode to 2560 x 1440 with 60 Hz	<p>The input signal (horizontal frequency and refresh rate) at the displayed input does not correspond to the technical data for the monitor.</p> <ul style="list-style-type: none"> ▶ Adjust the video frequency range using the computer software (see documentation for the computer or display adapter). ▶ Set a different screen resolution using the computer software (see documentation for the computer or display adapter).
Picture position not correct	<p>The monitor recognises an undefined mode (see chapter "Technical specification", Page 32).</p> <ul style="list-style-type: none"> ▶ Press the <input type="button" value="AUTO"/> button to perform auto-adjustment of the screen.
Picture is shaking	<ul style="list-style-type: none"> ▶ Check whether the data cable for the monitor is correctly attached to the monitor port on the computer. ▶ Press the <input type="button" value="AUTO"/> button to perform auto-adjustment of the screen.

Having this problem?	Check the following points:
Picture is wrongly adjusted	<ul style="list-style-type: none"> ▶ Run the <i>Factory Recall</i> function in the OSD menu. <p>The <i>Auto Processing</i> message appears.</p>
Picture disturbances (vertical lines)	<ul style="list-style-type: none"> ▶ Press the AUTO button to perform auto-adjustment of the screen.
Picture disturbances (horizontal lines, picture noise)	<ul style="list-style-type: none"> ▶ Press the AUTO button to perform auto-adjustment of the screen.
The screen becomes darker	<p>The background lighting has a limited lifetime. If your monitor display should become too dark, the background lighting will have to be replaced.</p> <ul style="list-style-type: none"> ▶ Contact our Service Desk.
<p>For DVI connection:</p> <p>Despite the correct resolution of 2560 x 1440, small fonts are not sharp or are illegible and black font is shown coloured. (The information menu of the monitor shows a resolution of 1280 x 1440).</p>	<ul style="list-style-type: none"> ▶ Use the DVI - Dual Link data cable which was supplied with the monitor.

Explanatory information about standard ISO 9241-307

Permanently unlit or lit pixels

Today's production techniques cannot guarantee an absolutely fault-free screen display. Depending on the total number of pixels (resolution), there may be a few constantly lit or unlit pixels or subpixels.

Pixel	A pixel consists of 3 subpixels, normally red, green and blue. A pixel is the smallest element that can be generated by complete functionality of the display.
Subpixel	A subpixel is a separately addressable internal structure within a pixel that enhances the pixel function.

The maximum permitted number of faulty pixels is stipulated in the international standard ISO 9241-307. In accordance with standard ISO 9241-3, LCD monitors by Fujitsu comply with Class II for low resolutions and Class I for resolutions of 1680 x 1050 (1764000 pixel) and higher.

Examples:

A flat-screen monitor with a resolution of 1280 x 1024 has $1280 \times 1024 = 1310720$ pixels. Each pixel consists of three subpixels (red, green and blue), so there are almost 3.9 million subpixels in total. According to ISO 9241-3 (Class II), a maximum of 3 lit and 3 unlit pixels plus 7 lit or 13 unlit subpixels, or a corresponding combination, may be faulty (1 lit subpixel counts as two unlit subpixels).

A flat-screen monitor with a resolution of 2560 x 1440 has $2560 \times 1440 = 3686400$ pixels. Each pixel consists of three subpixels (red, green and blue), so there are almost 11.1 million subpixels in total. According to ISO 9241-3 (Class I), a maximum of 2 lit and 2 unlit pixels plus 9 lit or 18 unlit subpixels, or a corresponding combination, may be faulty (1 lit subpixel counts as two unlit subpixels).

Technical specification



Condensation is not permitted, neither in the rated range of operation nor in the limit range of operation.

P27T-6 IPS

Dimensions and weight

Visible diagonals		68.5 cm
Dot pitch		0.2331 mm
Image size	Width	596.7 mm
	Height	335.7 mm
Maximum resolution		2560 x 1440
Dimensions incl. monitor base	Width	646 mm
	Height	417 mm
	Depth	252 mm
Weight (without packaging)		approx. 10.2 kg
Storable display modes		36
Pixel error classes according to ISO 9241-307	Class	I

Electrical data

Video	Analog	positive, 0.7 V _{ss} , 75 Ω
	Digital	DP/DVI-D/HDMI with HDCP
Synchronisation		Separate Sync. TTL, positive or negative
Horizontal frequency		30 kHz 99 kHz (multi-scanning)
Refresh rate		50 Hz 76 Hz
Maximum pixel rate		VGA: 193 MHz DVI, DP: 330 MHz
Power supply		Switches automatically 100 V – 240 V, 50 Hz – 60 Hz
Total power consumption (excluding audio, USB)	Normal operation	126 W
	ECO operating mode	85 W
	Power saving mode (0 W operating mode)	0 W
Sound output		2.0 W left; 2.0 W right

Environmental conditions

Environment class 3K2, DIN IEC 721

Rated range of operation	15 °C 35 °C
Humidity	20 % 85 %
Limit range of operation	5 °C 35 °C
Humidity	20 % 85 %

VESA-DDC-compatible VGA interface

Your monitor is equipped with a VESA-DDC-compatible VGA interface. VESA-DDC (Video Electronics Standard Association, Display Data Channel) is used as the communications interface between the monitor and the computer. If the computer is equipped with a VESA-DDC-compatible VGA interface, it can automatically read the data for ensuring optimum operation from the monitor and select the appropriate settings.

Preset operating modes

i

The picture position and size have been set to optimum values at the factory for the operating modes listed above. Depending on the display adapter used, it may be necessary to adjust the display position and size. In this case, you can change and save the settings (see chapter ["Changing the monitor settings", Page 19](#)).

For ergonomic reasons, a screen resolution of 2560 x 1440 pixels is recommended. Because of the technology used (active matrix), an LCD monitor provides a totally flicker-free picture, even with a refresh rate of 60 Hz.

Most frequent operating modes

Horizontal frequency	Refresh rate	Screen resolution
31.5 kHz	70 Hz	720 x 400
31.5 kHz	60 Hz	640 x 480
37.5 kHz	75 Hz	640 x 480
37.9 kHz	60 Hz	800 x 600
46.9 kHz	75 Hz	800 x 600
48.4 kHz	60 Hz	1024 x 768
55.4 kHz	60 Hz	1440 x 900
60.0 kHz	75 Hz	1024 x 768
64.0 kHz	60 Hz	1280 x 1024
65.0 kHz	60 Hz	1680 x 1050
74.0 kHz	60 Hz	1920 x 1200 (only VGA, DVI, DP)
80.0 kHz	75 Hz	1280 x 1024
88.7 kHz	60 Hz	2560 x 1440 (only DVI, DP)

Video/TV operating modes using DP and HDMI

Screen resolution	Refresh rate	Aspect ratio
720 x 480 i	60 Hz	4:3 / 16:9
720 x 480 p	60 Hz	4:3 / 16:9
720 x 576 i	50 Hz	4:3 / 16:9
720 x 576 p	50 Hz	4:3 / 16:9
1280 x 720 p	50 / 60 Hz	16:9
1920 x 1080 i	50 / 60 Hz	16:9
1920 x 1080 p	50 / 60 Hz	16:9

SUB D port

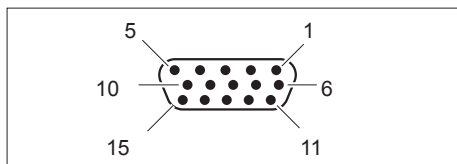

Pin	Meaning
1	Video input red
2	Video input green
3	Video input blue
4	Ground
5	Ground
6	Video ground red
7	Video ground green
8	Video ground blue
9	+5 V (DDC)
10	Sync. ground
11	Ground
12	DDC Data
13	H. sync
14	V. sync
15	DDC Clock

DVI-D port

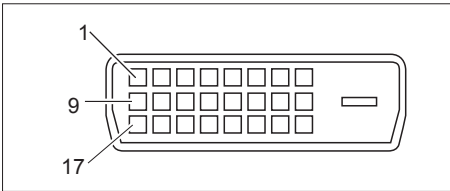

Pin	Meaning
1	TMDS Data2-
2	TMDS Data2+
3	TMDS Data 2/4 Shield
4	not connected
5	not connected
6	DDC Clock
7	DDC Data
8	Analog Vertical Sync
9	TMDS Data1-
10	TMDS Data1+
11	TMDS Data 1/3 Shield
12	not connected
13	not connected
14	+5V Power
15	Earth
16	Hot Plug Detect
17	TMDS Data0-
18	TMDS Data0+
19	TMDS Data 0/5 Shield
20	not connected
21	not connected
22	TMDS Clock Shield
23	TMDS Clock+
24	TMDS Clock-

DisplayPort socket

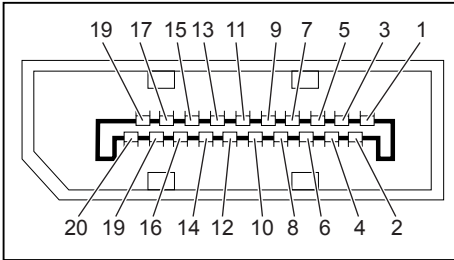

Pin	Meaning
1	Lane 3 (negative)
2	Earth
3	Lane 3 (positive)
4	Lane 1 (positive)
5	Earth
6	Lane 1 (negative)
7	Lane 2 (positive)
8	Earth
9	Lane 2 (negative)
10	Lane 0 (negative)
11	Earth
12	Lane 0 (positive)
13	Connected to earth
14	Connected to earth
15	Auxiliary channel (positive)
16	Earth
17	Auxiliary channel (negative)
18	Hot Plug Detect
19	Return for Power
20	Power for connector (3.3 V 500 mA)

HDMI port

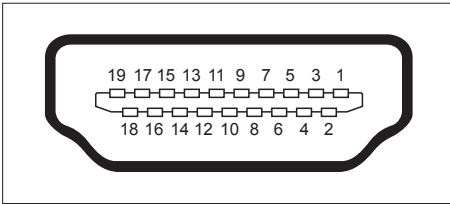

Pin	Meaning
1	TMDS Data2+
2	TMDS Data2 Shield
3	TMDS Data2-
4	TMDS Data1+
5	TMDS Data1 Shield
6	TMDS Data1-
7	TMDS Data0+
8	TMDS Data0 Shield
9	TMDS Data0-
10	TMDS Clock+
11	TMDS Clock Shield
12	TMDS Clock-
13	CEC
14	N.C.
15	SCL
16	SDA
17	DDC/CEC Ground
18	+5 V Power
19	Hot plug detect