



Digital Projector

User Manual

MW855UST+ / MH856UST+

V 1.00

Table of contents

Important safety instructions	3
Introduction	7
Projector features.....	7
Shipping contents	8
Projector exterior view.....	9
Controls and functions	11
Positioning your projector	15
Using the Quick Install.....	15
Obtaining a preferred projected image size.....	16
Mounting the projector	20
Dimensions.....	22
Connection	23
Connecting video source devices.....	24
Connecting smart devices.....	24
Playing sound through the projector	25
Operation	26
Starting up the projector	26
Adjusting the projected image	27
Using the menus.....	30
Securing the projector	31
Utilizing the password function	31
Switching input signal	33
Magnifying and searching for details ...	34
Selecting the aspect ratio	35
Optimizing the image	37
Setting the presentation timer	41
Remote paging operations	42
Freezing the image	42
Hiding the image.....	42
Locking control keys.....	43
Operating in a high altitude environment.....	43
Adjusting the sound	44
Using the test pattern.....	45
Using the teaching templates	45
Controlling the projector through a wired LAN environment.....	46
Installing PointWrite module on projector to use interaction function	51
Shutting down the projector	52
Menu operation	53
Maintenance	66
Care of the projector	66
Light information	67
Troubleshooting	74
Specifications	75
Projector specifications.....	75
Timing chart.....	76
Warranty and Copyright information	82

Important safety instructions

Your projector is designed and tested to meet the latest standards for safety of information technology equipment. However, to ensure safe use of this product, it is important that you follow the instructions mentioned in this manual and marked on the product.

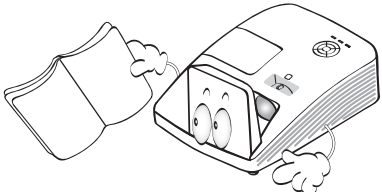
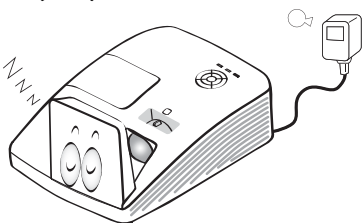
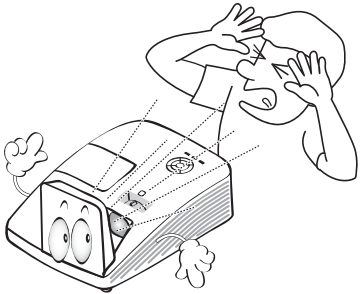
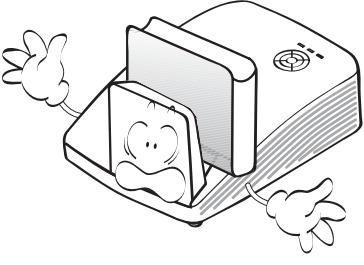
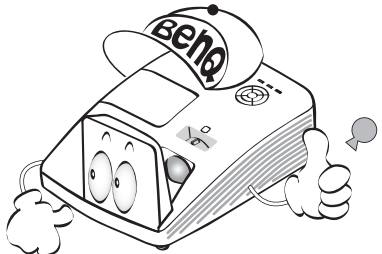
Safety Instructions	
<p>1. Please read this manual before you operate your projector. Save it for future reference.</p>	<p>4. In some countries, the line voltage is NOT stable. This projector is designed to operate safely within a mains voltage between 100 to 240 volts AC, but could fail if power cuts or surges of ± 10 volts occur. In areas where the mains voltage may fluctuate or cut out, it is recommended that you connect your projector through a power stabilizer, surge protector or uninterruptible power supply (UPS).</p>
	
<p>2. Do not look straight at the projector lens during operation. The intense light beam may damage your eyes.</p>	<p>5. Do not block the projection lens with any objects when the projector is under operation as this could cause the objects to become heated and deformed or even cause a fire. To temporarily turn off the lamp, press ECO BLANK on the remote control.</p>
	
<p>3. Refer servicing to qualified service personnel.</p>	
	

Safety Instructions (Continued)

6. The lamp becomes extremely hot during operation. Allow the projector to cool for approximately 45 minutes prior to removing the lamp assembly for replacement.

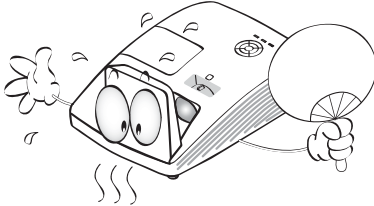

7. Do not operate lamps beyond the rated lamp life. Excessive operation of lamps beyond the rated life could cause them to break on rare occasions.

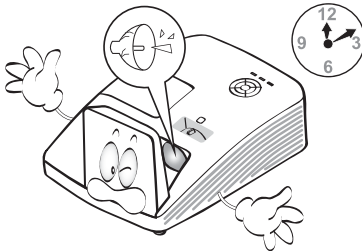

8. Never replace the lamp assembly or any electronic components unless the projector is unplugged.

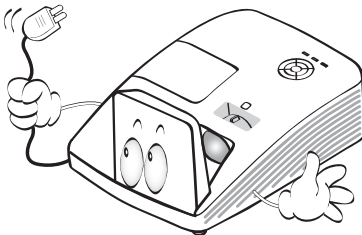

9. Do not place this product on an unstable cart, stand, or table. The product may fall, sustaining serious damage.

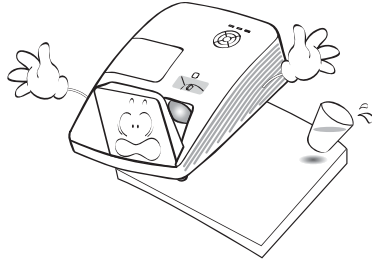

10. Do not attempt to disassemble this projector. There are dangerous high voltages inside which may cause death if you should come into contact with live parts. The only user serviceable part is the lamp which has its own removable cover. Under no circumstances should you ever undo or remove any other covers. Refer servicing only to suitably qualified professional service personnel.

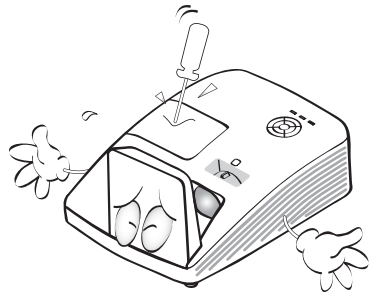

11. When the projector is under operation, you may sense some heated air and odor from its ventilation grill. It is a normal phenomenon and not a product defect.

Safety Instructions (Continued)

12. Do not place this projector in any of the following environments.
- Space that is poorly ventilated or confined. Allow at least 50 cm clearance from walls and free flow of air around the projector.
 - Locations where temperatures may become excessively high, such as the inside of a car with all windows rolled up.
 - Locations where excessive humidity, dust, or cigarette smoke may contaminate optical components, shortening the projector's life span and darkening the image.

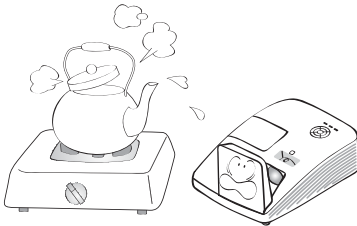

- Locations near fire alarms
- Locations with an ambient temperature above 40°C / 104°F
- Locations where the altitudes are higher than 3000 m (10000 feet).

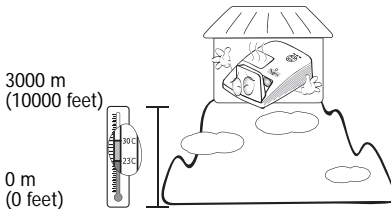

13. Do not block the ventilation holes.
- Do not place this projector on a blanket, bedding or any other soft surface.
 - Do not cover this projector with a cloth or any other item.
 - Do not place inflammables near the projector.

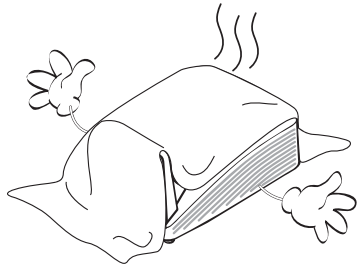

If the ventilation holes are seriously obstructed, overheating inside the projector may result in a fire.

14. Always place the projector on a level, horizontal surface during operation.
- Do not use if tilted at an angle of more than 10 degrees left to right, nor at angle of more than 15 degrees front to back. Using the projector when it is not fully horizontal may cause a malfunction of, or damage to, the lamp.

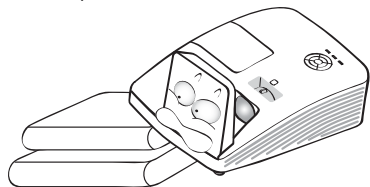

Safety Instructions (Continued)

15. Do not stand the projector on end vertically. Doing so may cause the projector to fall over, causing injury or resulting in damage to the projector.

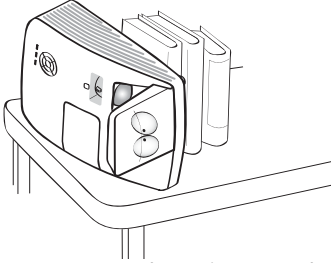

16. Do not step on the projector or place any objects upon it. Besides probable physical damage to the projector, doing so may result in accidents and possible injury.

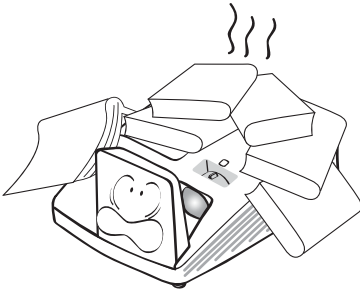

17. Do not place liquids near or on the projector. Liquids spilled into the projector may cause it to fail. If the projector does become wet, disconnect it from the power supply's wall socket and call BenQ to have the projector serviced.

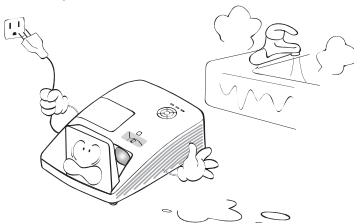

18. This product is capable of displaying inverted images for wall mount installation.



Use only BenQ's Wall Mount Kit for mounting the projector and ensure it is securely installed.

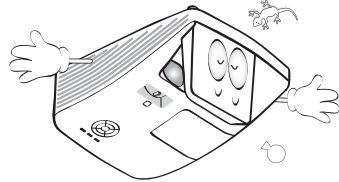

Wall mounting the projector

We want you to have a pleasant experience using your BenQ projector, so we need to bring this safety matter to your attention to prevent possible damage to person and property.

If you intend to mount your projector on the wall, we strongly recommend that you use a proper fitting BenQ projector wall mount kit and that you ensure it is securely and safely installed.

If you use a non-BenQ brand projector wall mount kit, there is a safety risk that the projector may fall from the wall due to an improper attachment through the use of the wrong gauge or length screws.

You can purchase a BenQ projector wall mount kit from the place you purchased your BenQ projector. BenQ recommends that you also purchase a separate Kensington lock compatible security cable and attach it securely to both the Kensington lock slot on the projector and the base of the wall mount bracket. This will perform the secondary role of restraining the projector should its attachment to the mounting bracket become loose.



Hg - Lamp contains mercury. Manage in accordance with local disposal laws. See www.lamprecycle.org.

Introduction

Projector features

The projector offers the following features

- **SmartEco™ starts your dynamic power saving**

The SmartEco™ technology offers a new way of operating the projector lamp system and saves lamp power up to 30% depending on the content brightness level.

- **Interactive capability**

Extend the interactive function with optional PointWrite module.

- **Vertical 2% lens shift (No available in MH856UST+)**

Optimize the installation flexibility.

- **Corner fit**

Correct each distorted corner to get a perfect rectangular image.

- **Filter Free**

Filter free design to lower maintenance and operating costs.

- **Network Control**

Integrated RJ45 connector for wired network control allowing management of projector status from a computer using a web browser.

Enable Network Standby mode <2W.

- **Crestron RoomView®, and AMX supported**

The projector supports Crestron eControl and RoomView and AMX allowing you to control and manage equipment from a remote computer via LAN connection.

- **One-key auto-adjustment**

Pressing **AUTO** on the keypad or remote control to show the best picture quality immediately.

- **Built-in 10W x 2 speaker(s)**

Built-in 10W x 2 speaker(s) providing stereo audio when an audio input is connected.

- **Quick Cooling, Auto Power Off, Signal Power On, Direct Power On**

Quick Cooling function speeds up the cooling process when turning off the

projector. **Auto Power Off** function allows the projector to turn off automatically if

no input signal is detected after a set period of time. **Signal Power On** function turns

on your projector automatically once detecting the signal input and **Direct Power On**

boots up the projector automatically when the power is connected.



- **The apparent brightness of the projected image will vary depending on the ambient lighting conditions, selected input signal contrast/brightness settings, and is directly proportional to projection distance.**

- **The lamp brightness will decline over time and may vary within the lamp manufacturers specifications. This is normal and expected behavior.**

Shipping contents

Carefully unpack and verify that you have all of the items shown below. If any of these items are missing, please contact your place of purchase.

Standard accessories

 The supplied accessories will be suitable for your region, and may differ from those illustrated.

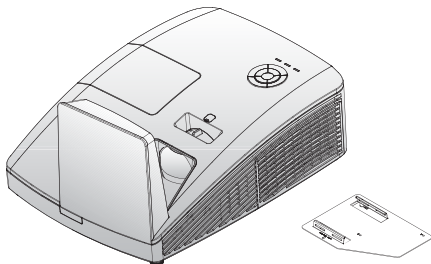

Projector with wall mount plate

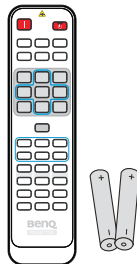

Remote control with battery**

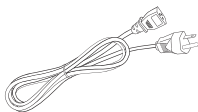

Power cord

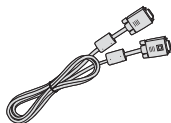

VGA cable

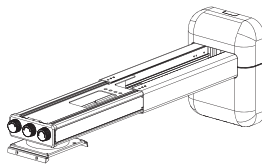

Wall mount kit (WM04G4) & user manual



Hex key (2.5mm)***



Quick start guide



Warranty card*



Installation chart for wallmount

Optional accessories

1. Spare lamp kit
2. 3D glasses
3. Wireless dongle: QCastMirror (QP20)
4. PointWrite kit (PW30U)
5. PointWrite Touch module (PT20)

*The warranty card is only supplied in some specific regions. Please consult your dealer for detailed information.

**There is no Laser function of the remote for Japan region.

***Hex key not available in MH856UST+ model.

Projector exterior view

Front/upper side

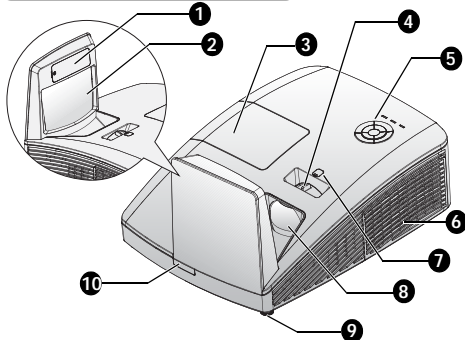

1. PointWrite dummy cover (Optional PointWrite kit)
2. Mirror
3. Lamp compartment cover
4. Focus ring
5. External control panel (See "Projector" on page 11 for details.)
6. Vent (cool air intake)
7. Lens shift (No available in MH856UST+)
8. Projection lens
9. Front adjuster foot
10. Front IR remote sensor

Rear/lower side

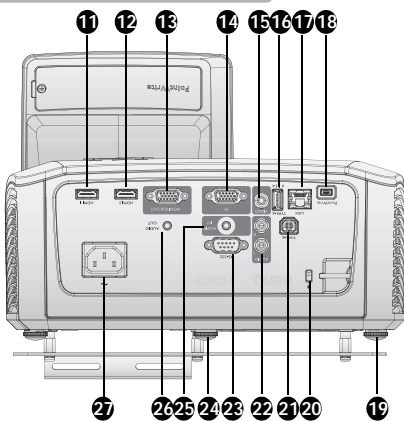

11. HDMI-1 input jack
12. HDMI-2 input jack
13. RGB signal output jack
14. PC input jack
15. VIDEO input jack
16. USB Type A port
17. RJ45 LAN input jack
18. PointWrite port (PointWrite kit is required)
19. Front adjuster foot
20. Kensington anti-theft lock slot
21. USB Type B port (For service download)
22. Audio (L/R) input jack
23. RS-232 control port
24. Rear adjuster foot
25. Audio input jack
26. Audio output jack
27. AC power cord inlet



For setting the PointWrite kit on projector, Please find PointWrite manual in the kit box you purchase.

28. Wall mount plate

Bottom side

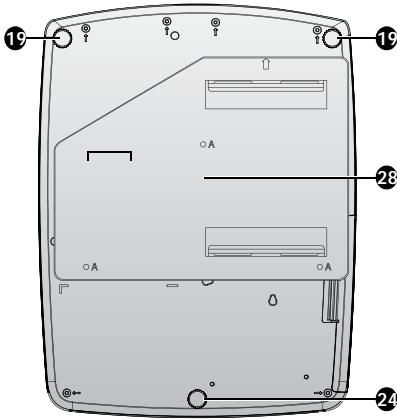

Controls and functions

Projector



1. **FOCUS Ring**
Used to adjust the projected image appearance. See ["Fine-tuning the image size and clarity"](#) on page 27 for details.
2. **Lens Shift**
Used Hex Key to adjust the lens shift function.
3. **MENU/EXIT**
Turns on the On-Screen Display (OSD) menu. Goes back to previous OSD menu, exits and saves menu settings. See ["Using the menus"](#) on page 30 for details.
4. **Keystone/Arrow keys (▼/▲ Up)**
Manually corrects distorted images resulting from an angled projection.
5. **SOURCE**
Displays the source selection bar. See ["Switching input signal"](#) on page 33 for details.
6. **◀ Left/ 🔊 Decrease volume level**
Decreases volume. See ["Adjusting the sound level"](#) on page 44 for details.
7. **POWER indicator light**
Lights up or flashes when the projector is under operation. See ["Indicators"](#) on page 73 for details.
8. **MODE/ENTER**
Selects an available picture setup mode. See ["Selecting a picture mode"](#) on page 37 for details.
Enacts the selected On-Screen Display (OSD) menu item. See ["Using the menus"](#) on page 30 for details.
9. **▶ Right/ 🔊 Increase volume level**
Increases volume. See ["Adjusting the sound level"](#) on page 44 for details.
When the On-Screen Display (OSD) menu is activated, the #4, #6, #9, and #11 keys are used as directional arrows to select the desired menu items and to make adjustments. See ["Using the menus"](#) on page 30 for details.
10. **AUTO**
Automatically determines the best picture timings for the displayed image. See ["Auto-adjusting the image"](#) on page 27 for details.
11. **Keystone/Arrow keys (▲/▼ Down)**
Manually corrects distorted images resulting from an angled projection.
12. **POWER**
Toggles the projector between standby mode and on.
See ["Starting up the projector"](#) on page 26 and ["Shutting down the projector"](#) on page 52 for details.
13. **LAMP indicator light**
Indicates the status of the lamp. Lights up or flashes when the lamp has developed a problem. See ["Indicators"](#) on page 73 for details.
14. **TEMPERATURE indicator light**
Lights up red if the projector's temperature becomes too high. See ["Indicators"](#) on page 73 for details.

Remote Control

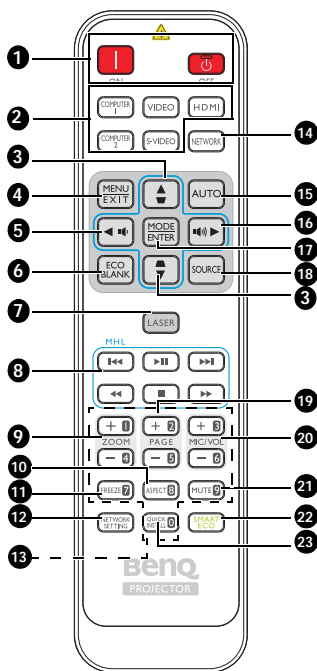

1. **ON / OFF**
Toggles the projector between standby mode and on.
2. **Source selection buttons (Computer 2, S-Video and Network are not available in this model)**
Selects an input source for display.
3. **Keystone/Arrow keys (▼/▲ Up, ▲/▼ Down)**
Manually corrects distorted images resulting from an angled projection.
4. **MENU/EXIT**
Turns on the On-Screen Display (OSD) menu. Goes back to previous OSD menu, exits and saves menu settings.
5. **Left/** **Decreases the projector volume.**
6. **ECO BLANK**
Used to hide the screen picture.

7. **LASER (Not available in Japan)**
Emits visible laser pointer light for presentation purposes.
 8. **MHL control buttons (Not available in this model)**
 9. **ZOOM+/ZOOM-**
Magnifies or reduces the projected picture size.
 10. **ASPECT**
Selects the display aspect ratio.
 11. **FREEZE**
Freezes the projected image.
 12. **NETWORK SETTING**
Displays the **Network Settings** OSD menu.
 13. **Numeric buttons**
Enters numbers in network settings.
- Numeric buttons 1, 2, 3, 4 cannot be pressed when asked to enter password.**

14. **NETWORK**
Selects Network Display as the input signal source.
15. **AUTO**
Automatically determines the best picture timings for the displayed image.
16. **Right/** **Increases the projector volume.**
When the On-Screen Display (OSD) menu is activated, the #3, #5, and #16 keys are used as directional arrows to select the desired menu items and to make adjustments.
17. **MODE/ENTER**
Selects an available picture setup mode. Activates the selected On-Screen Display (OSD) menu item.

18. SOURCE

Displays the source selection bar.

19. PAGE +/PAGE -

Operate your display software program (on a connected PC) which responds to page up/down commands (like Microsoft PowerPoint).

20. MIC/VOL +/MIC/VOL -

The function is not available on this projector.

21. MUTE

Toggles projector audio between on and off.

22. SMART ECO

Switch the light mode between Eco/ Normal and SmartEco.

23. QUICK INSTALL

Displays the **Quick Install** OSD menu.

Operating the LASER pointer

The Laser Pointer is a presentation aid for professionals. It emits a beam of red light when you press it.

The laser beam is visible. It is necessary to press and hold LASER for continuous output.



Do not look into the laser light window or shine the laser light beam on yourself or others. See the warning messages on the back of the remote control prior to using it.

The laser pointer is not a toy. Parents should be mindful of the dangers of laser energy and keep this remote control out of the reach of children.

Avoid Exposure
Laser radiation is emitted from this aperture



Replacing the remote control battery

1. To open the battery cover, turn the remote control over to view its back, push on the finger grip on the cover and slide it up in the direction of the arrow as illustrated. The cover will slide off.
2. Remove any existing batteries (if necessary) and install two AAA batteries observing the battery polarities as indicated in the base of the battery compartment. Positive (+) goes to positive and negative (-) goes to negative.
3. Refit the cover by aligning it with the base and sliding it back down into position. Stop when it clicks into place.

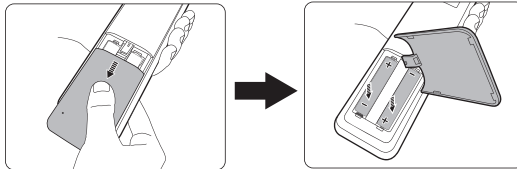

- **Avoid excessive heat and humidity.**
- **There may be battery damage if the battery is incorrectly replaced.**
- **Replace only with the same or equivalent type recommended by the battery manufacturer.**
- **Dispose of the used battery according to the battery manufacturer's instructions.**
- **Never throw a battery into a fire. There may be danger of an explosion.**
- **If the battery is dead or if you will not be using the remote control for a long time, remove the battery to prevent damage to the remote control from possible battery leakage.**

Remote control effective range

Infra-Red (IR) remote control sensor is located on the front of the projector. The remote control must be held at an angle within 30 degrees perpendicular to the projector's IR remote control sensor to function correctly. The distance between the remote control and the sensor should not exceed 8 meters (~ 26 feet).

Make sure that there are no obstacles between the remote control and the IR sensor on the projector that might obstruct the infra-red beam.

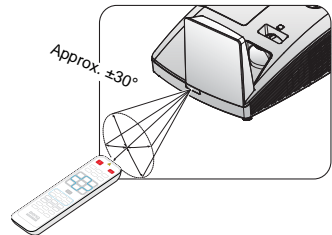

Positioning your projector

Using the Quick Install

The projector provides a hot key to set **Projector Installation**, **Test Pattern**, and **Keystone** quickly.

Press **Quick Install** on the remote control and press **▲/▼** to select:

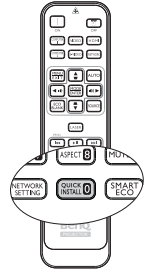
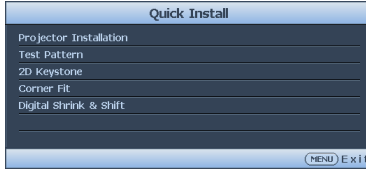

- Projector Installation: See "[Positioning your projector](#)" on page 15.
- Test Pattern: See "[Using the test pattern](#)" on page 45.
- Keystone: See "[Correcting 2D Keystone](#)" on page 28.

1. Choosing a location

Your projector is designed to be installed in one of four possible installation locations:

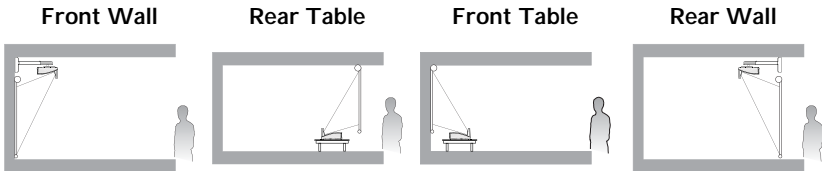

2. Use the test pattern

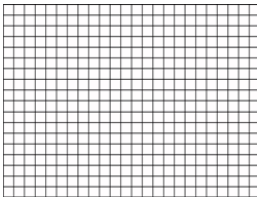

3. Correct the image

2D Keystone correction



Corner fit correction



Digital shrink and shift

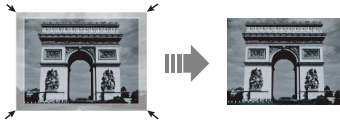

Set up your screen via **Quick Install** hotkey on remote, you can also go to the **SYSTEM SETUP: Basic > Projector Installation** menu after turning on the projector.

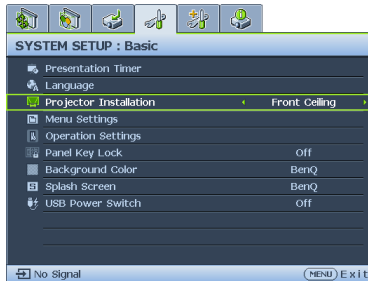

Your room layout or personal preference will dictate which installation location you select. Take into consideration the size and position of your screen, the location of a suitable power outlet, as well as the location and distance between the projector and the rest of your equipment.

Obtaining a preferred projected image size

1. Wall mount
2. Dimension (include projector and wall mount)

Projection dimensions

Refer to "Dimensions" on page 22 for the center of lens dimensions of this projector before calculating the appropriate position.

 To install the PointWrite Touch module, download the file "installation guide for PointWrite Touch module" from the BenQ website.

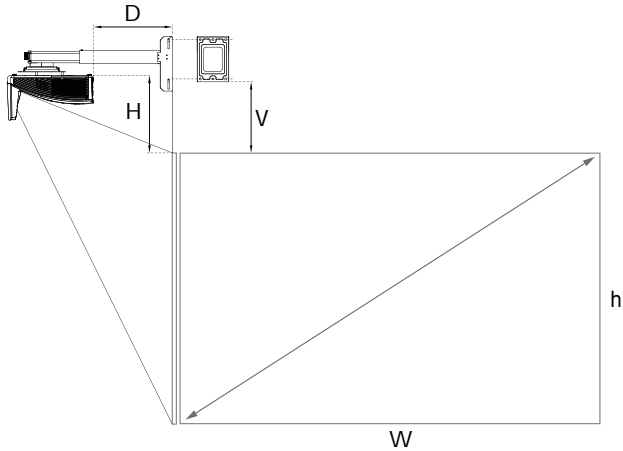

MW855UST+

The screen aspect ratio is 16:10 and the projected picture is 16:10.

WXGA											
Screen size (Diagonal)		Screen width (W)		Screen Height (h)		Projection distance (D)		Offset (H)		Scale parameter	Distance between Wall plate & projection screen (V)
inch	mm	inch	mm	inch	mm	inch	mm	inch	mm	mm	
80	2032	67	1723	42	1077	11.40	289.0	11.80	300.0	505	274.7
85	2159	71	1831	45	1144	12.90	326.9	12.40	314.3	540	289.0
87	2210	73	1874	46	1171	13.50	341.9	12.60	320.2	555	294.9
90	2286	76	1939	47	1212	14.40	364.7	13.00	328.9	580	303.6
92	2337	77	1982	48	1239	15.00	379.7	13.20	334.4	595	309.1
95	2413	80	2046	50	1279	15.80	402.1	13.50	343.0	615	317.7
97	2464	81	2089	51	1306	16.40	417.2	13.70	348.9	630	323.6
100	2540	85	2154	53	1346	17.30	439.9	14.00	356.9	655	331.6

MH856UST+

The screen aspect ratio is 16:9 and the projected picture is 16:9.

1080P											
Screen size (Diagonal)		Screen width (W)		Screen Height (h)		Projection distance (D)		Offset (H)		Scale parameter	Distance between Wall plate & projection screen (V)
inch	mm	inch	mm	inch	mm	inch	mm	inch	mm	mm	
89	2258	77.5	1968	43.6	1107	13.20	335.4	13.00	331.2	550	305.9
90	2286	78.4	1991	44.1	1120	13.50	343.0	13.20	334.5	560	309.2
95	2413	82.8	2103	46.6	1183	14.96	380.0	13.80	350.5	595	325.2
97	2464	84.5	2148	47.6	1208	15.55	395.0	14.00	356.7	610	331.4
100	2540	87.1	2213	49.0	1245	16.39	416.3	14.40	366.2	630	340.9
102	2594	89.1	2262	50.1	1272	17.03	432.5	14.70	373.3	645	348

 There is 5% tolerance among these numbers due to optical component variations. BenQ recommends that if you intend to permanently install the projector, you should physically test the projection size and distance using the actual projector before you permanently install it, so as to make allowance for this projector's optical characteristics. This will help you determine the exact mounting position so that it best suits your installation location.

 It is recommended to adjust focus 15 minutes after powering on due to the slight shifting of the lens from temperature changing.

Limited lens shift specification (No available in MH856UST+)

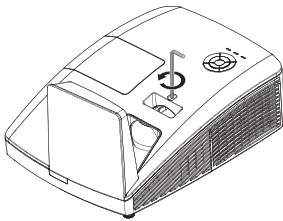
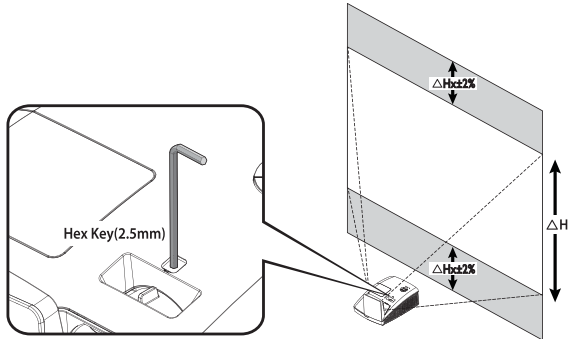

To shift up the projection image, twist the adjuster counter clockwise.

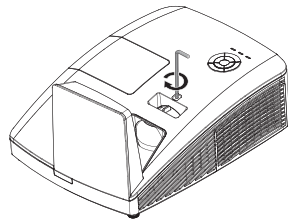

To shift down the projection image, twist the adjuster clockwise.

Mounting the projector

If you intend to mount your projector, we strongly recommend that you use a proper fitting BenQ projector mounting kit and that you ensure it is securely and safely installed.

If you use a non-BenQ brand projector mounting kit, there is a safety risk that the projector may fall down due to an improper attachment through the use of the wrong gauge or length screws.

Before mounting the projector

- Use BenQ Projector Wall Mounting Kit come with the package. Please refer to the User manual in the box of wall mount kit for installation details.
- BenQ recommends that you also purchase a separate Kensington lock compatible security cable and attach it securely to both the Kensington lock slot on the projector and the base of the mounting bracket. This will perform the secondary role of restraining the projector should its attachment to the mounting bracket become loose.
- Ask your dealer to install the projector for you. Installing the projector on your own may cause it to fall and result in injury.
- Take necessary procedures to prevent the projector from falling off such as during an earthquake.
- The warranty doesn't cover any product damage caused by mounting the projector with a non-BenQ brand projector mounting kit.
- Consider the surrounding temperature where the projector is ceiling/wall mounted. If a heater is used, the temperature around the ceiling may be higher than expected.
- Read the user manual for the mounting kit about the range of torque. Tightening with torque exceeding the recommended range may cause damage to the projector and subsequently falling off.
- Make sure the power outlet is at an accessible height so that you can easily shut down the projector.

Install the projector on the projector wall mount

1. Slide the projector into the wall mount.

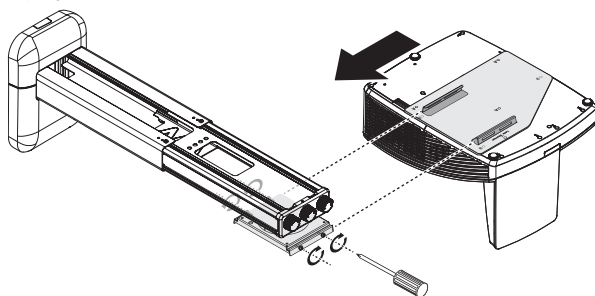

2. Adjust the Vertical Tilt/Horizontal Roll/Horizontal Rotation to adjust screen alignment and image position.

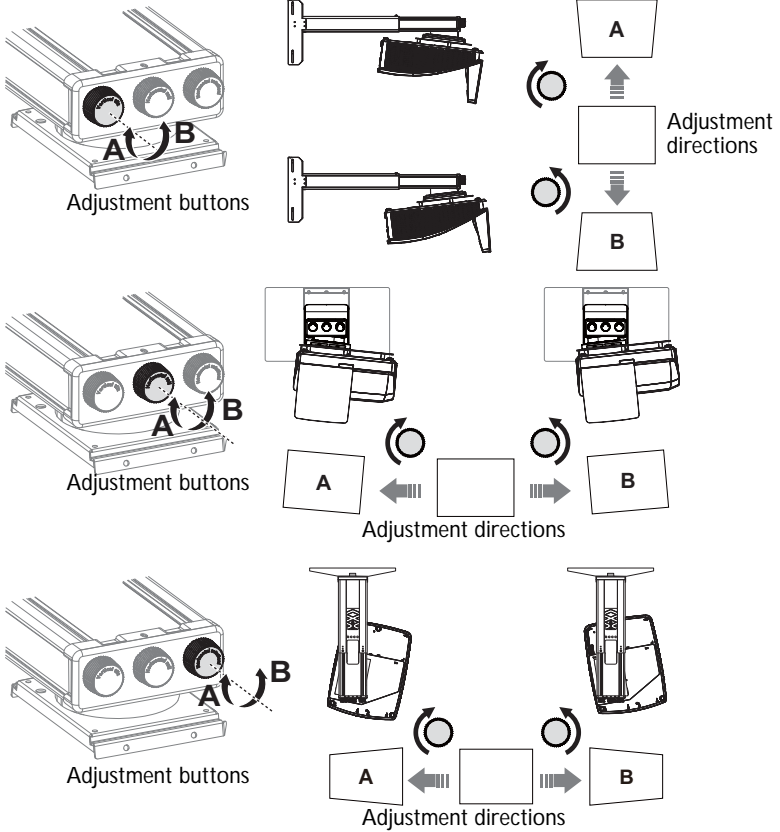

3. Adjust the Forward/Backward Slide to reduce/enlarge the image.

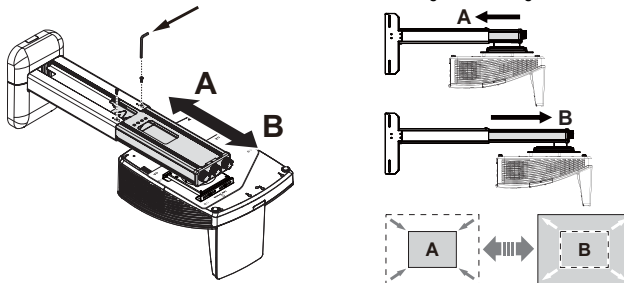

Dimensions

287.5 mm (W) x 206.9 mm (H) x 373.3 mm (D)

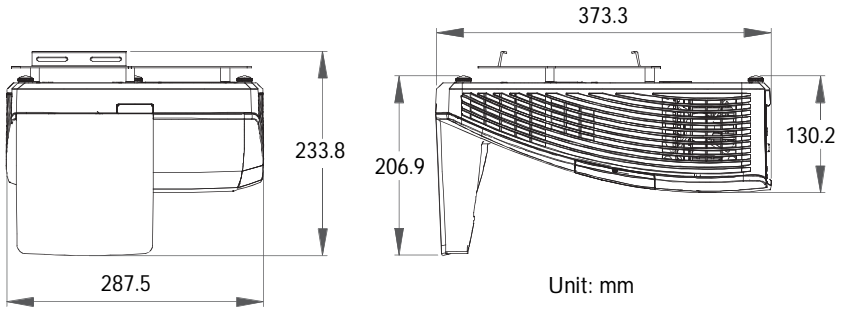

Wall Mount Installation

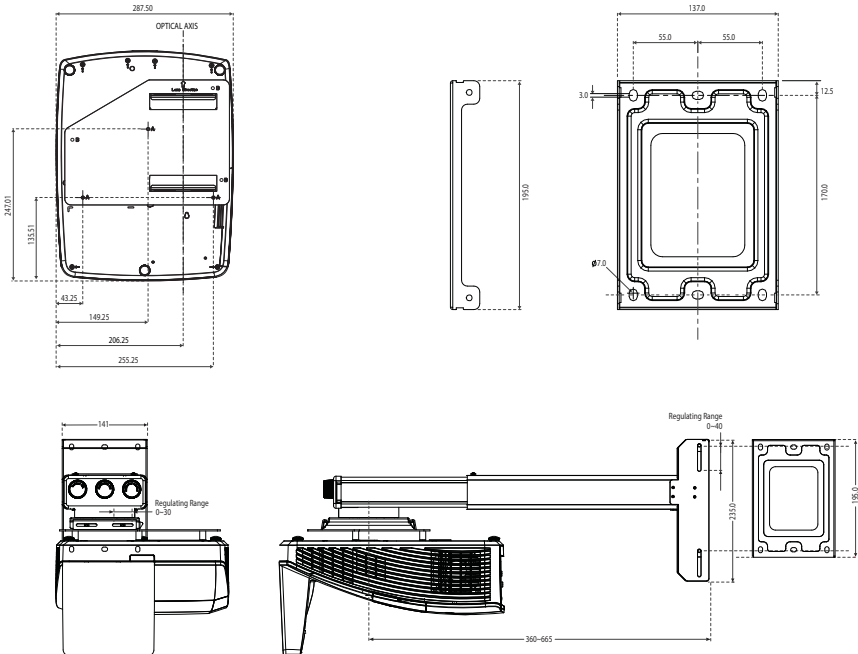

Connection

When connecting a signal source to the projector, be sure to:

1. Turn all equipment off before making any connections.
2. Use the correct signal cables for each source.
3. Ensure the cables are firmly inserted.

In the connections shown below, some cables may not be included with the projector (see "Shipping contents" on page 8). They are commercially available from electronics stores.

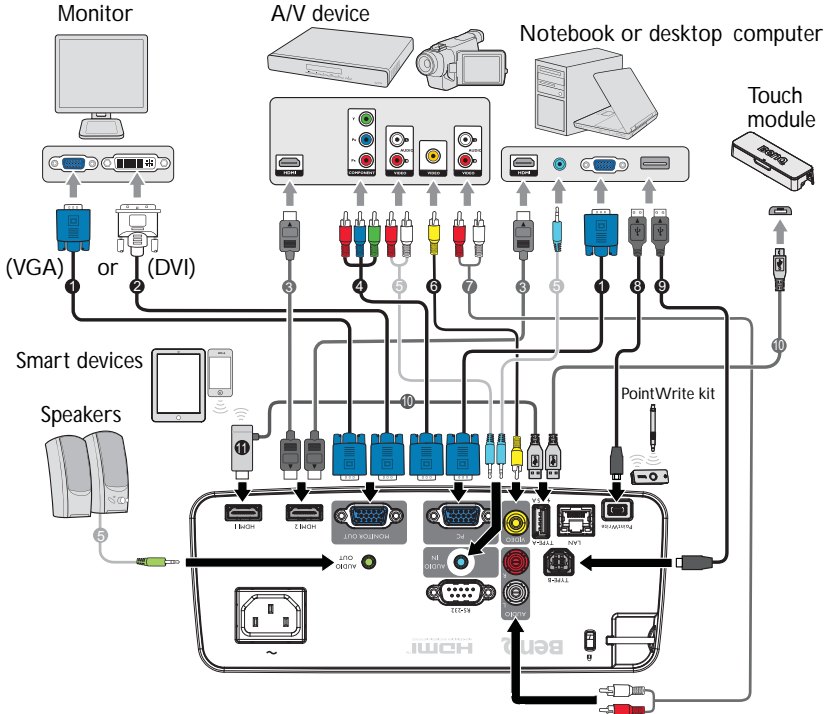



- | | |
|---|--|
| <ol style="list-style-type: none"> 1. VGA cable 2. VGA to DVI-A cable 3. HDMI cable 4. Component Video to VGA (D-Sub) adapter cable 5. Audio cable 6. Video cable | <ol style="list-style-type: none"> 7. Audio L/R cable 8. USB cable 9. USB cable (B to A type) 10. USB cable (A to micro B type): Connect to PointWrite Touch module or connect to the HDMI dongle for power supply 11. HDMI dongle (iCast Mirror, etc.) |
|---|--|

 Many notebooks do not turn on their external video ports when connected to a projector. Usually a key combo like FN + F3 or CRT/LCD key turns the external display on/off. Locate a function key labeled CRT/LCD or a function key with a monitor symbol on the notebook. Press FN and the labeled function key simultaneously. Refer to your notebook's documentation to find your notebook's key combination.

Connecting video source devices

You need only connect the projector to a video source device using just one of the connecting methods, however each provides a different level of video quality. The method you choose will most likely depend upon the availability of matching terminals on both the projector and the video source device as described below:

Terminal name	Terminal appearance	Picture quality
HDMI		Best
Component Video		Better
Video		Normal

Connecting audio

The projector has two built-in speaker which are designed to provide basic audio functionality accompanying data presentations for business purposes only. They are not designed for, nor intended for stereo audio reproduction use as might be expected in home theater or home cinema applications.

The built-in speaker will be muted when the **AUDIO OUT** jack is connected.

 If the selected video image is not displayed after the projector is turned on and the correct video source has been selected, check that the video source device is turned on and operating correctly. Also check that the signal cables have been connected correctly.

Connecting smart devices

The projector can project the content directly from a smart device by using a wireless dongle.

HDMI wireless dongle (e.g. BenQ QCastMirror)

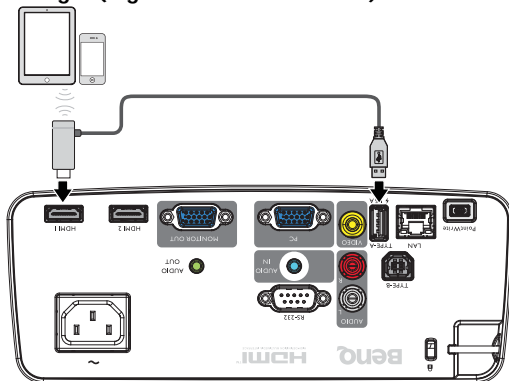

- Connect the dongle to HDMI 1 or HDMI 2 and USB TYPE-A ports on the projector and switch the input signal to HDMI 1 or HDMI 2.

Playing sound through the projector

You can make use of the projector speaker in your presentations, and also connect separate amplified speakers to the AUDIO OUT socket of the projector.

If you have a separate sound system, you will most likely want to connect the audio output of your Video source device to that sound system, instead of to the audio projector.

Once connected, the audio can be controlled by the projector On-Screen Display (OSD) menus.

The table below describes the connection methods for different devices, and where the sound is from.

Device	Computer/PC	Component/Video	HDMI
Audio input port	AUDIO IN (mini jack)	AUDIO (L/R)	HDMI
The projector can play the sound from...	AUDIO IN (mini jack)	AUDIO (L/R)	HDMI
Audio output port	AUDIO OUT	AUDIO OUT	AUDIO OUT
The selected input signal determines which sound will be played by the projector speaker, and which sound will be output from the projector when AUDIO OUT is connected. If you select the COMPUTER/PC signal, the projector can play the sound received from AUDIO IN mini jack. If you select the COMPONENT/VIDEO signal, the projector can play the sound received from AUDIO (L/R).			

Operation



Starting up the projector

1. Plug the power cord into the projector and into a wall socket. Turn on the wall socket switch (where fitted). Check that the **POWER indicator light** on the projector lights orange after power has been applied.

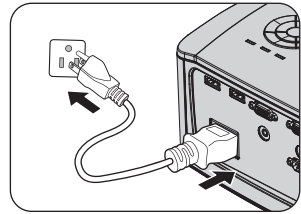

Please use the original accessories (e.g. power cable) only with the device to avoid possible dangers such as electric shock and fire.



2. Press **POWER** on the projector  or remote control  to start the projector and a start up tone sounds. The **POWER indicator light** flashes green and stays green when the projector is on.

The start up procedure takes about 30 seconds. In the later stage of start up, a startup logo is projected.

(If necessary) Rotate the focus ring to adjust the image clearness.

To turn off the ring tone, see "[Turning off the power on/off ring tone](#)" on page 44 for details.



If the projector is still hot from previous activity, it will run the cooling fan for approximately 90 seconds before energizing the lamp.

3. To use the OSD menus, please set them to your familiar language first.
4. If you are prompted for a password, press the arrow keys to enter a five digit password. See "[Utilizing the password function](#)" on page 31 for details.
5. Switch all of the connected equipment on.
6. The projector will start to search for input signals. The current input signal being scanned displays in the upper left corner of the screen. If the projector doesn't detect a valid signal, the message '**No Signal**' will continue displaying until an input signal is found.

Please Select Language			
English	한국어	Hrvatski	हिन्दी
Français	Svenska	Română	
Deutsch	Nederlands	Norsk	
Italiano	Türkçe	Dansk	
Español	Čeština	Български	
Русский	Português	suomi	
繁體中文	Tiếng	Indonesian	
简体中文	Polski	Ελληνικά	
日本語	Magyar	Հայերեն	

Press Enter to confirm, Exit to leave

You can also press **SOURCE** on the projector or remote control to select your desired input signal. See "[Switching input signal](#)" on page 33 for details.



If the frequency/resolution of the input signal exceeds the projector's operating range, you will see the message 'Out of Range' displayed on a blank screen. Please change to an input signal which is compatible with the projector's resolution or set the input signal to a lower setting. See "[Timing chart](#)" on page 76 for details.



To maintain the lamp life, once you turn the projector on, wait at least 5 minutes before turning it off.

Adjusting the projected image

Adjusting the projection angle

The projector is equipped with 3 adjuster feet. These adjusters change the image height and projection angle. To adjust the projector:

Screw adjuster foot to fine tune the horizontal angle.

To retract the foot, hold up the projector then slowly lower the projector. Screw the adjuster foot in a reverse direction.

If the projector is not placed on a flat surface or the screen and the projector are not perpendicular to each other, the projected image becomes trapezoidal. To correct this situation, see "[Correcting 2D Keystone](#)" on page 28 for details.

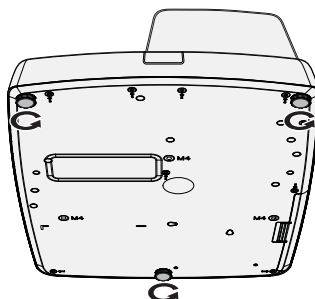

- Do not look into the lens while the lamp is on. The strong light from the lamp may cause damage to your eyes.
- Be careful when you press the adjuster button as it is close to the exhaust vent where hot air comes from.

Auto-adjusting the image

In some cases, you may need to optimize the picture quality. To do this, press **AUTO** on the projector or remote control. Within 3 seconds, the built-in Intelligent Auto Adjustment function will re-adjust the values of Frequency and Clock to provide the best picture quality.

The current source information will be displayed in the upper left corner of the screen for 3 seconds.



- The screen will be blank while **AUTO** is functioning.
- This function is only available when PC signal (analog RGB) is selected.

Fine-tuning the image size and clarity

Sharpen the image by rotating the FOCUS ring.

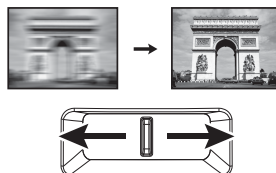

Correcting 2D Keystone

2D Keystone function enables a wider projector installation area compared to conventional projectors with limited positioning in front of the screen.

To correct this, you will need to manually correct it following one of these steps.

- Using the projector or remote control

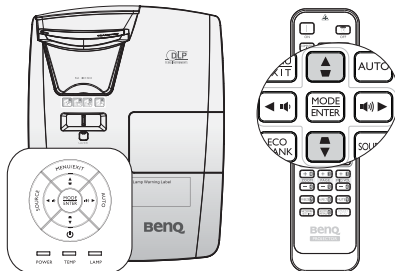

Press **▼/▲** on the projector or remote control to display the 2D Keystone page. Press **▲/▼** to adjust vertical values from -15 to 15. Press **◀/▶** to adjust horizontal values from -15 to 15.

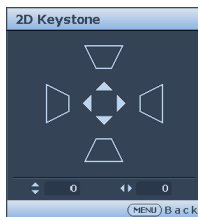

- Using the OSD menu
 - Press **MENU/EXIT** and then press **◀/▶** until the **Display** menu is highlighted.
 - Press **▼** to highlight **2D Keystone** and press **MODE/ENTER**. The **2D Keystone** page displays.
 - Press **▲, ▼, ◀, ▶** to adjust the keystone values.



- Using the **QUICK INSTALL** key
 - Press **QUICK INSTALL** on the remote control.

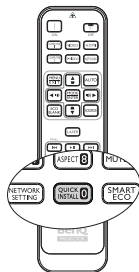

- Press **▼** to highlight **2D Keystone** and press **MODE/ENTER**. The **2D Keystone** page displays.
- Press **▲, ▼, ◀, ▶** to adjust the keystone values.

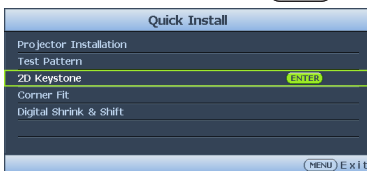

Correcting Corner Fit

Manually adjust four corners of the image by setting the horizontal and vertical values.

- Using the OSD menu
- Press **MENU/EXIT** and then press **◀/▶** until the **Display** menu is highlighted.
 - Press **▼** to highlight **Corner Fit** and press **MODE/ENTER**. The **Corner Fit** page displays.
 - Press **▲, ▼, ◀, ▶** to select one of the four corners and press **MODE/ENTER**.
 - Press **◀/▶** to adjust vertical values from 0 to 60.
 - Press **▲/▼** to adjust horizontal values from 0 to 60.

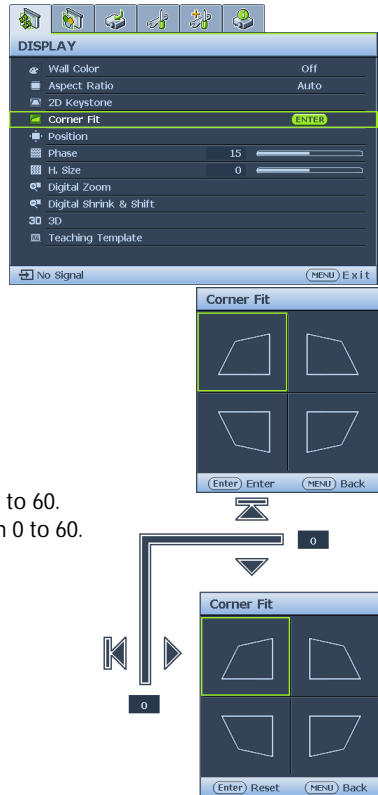

Corner Fit and 2D Keystone Adjustment Notice

The corner fit function is closely related to the 2D keystone function as both make adjustments to correct picture distortion. Therefore, when correcting picture distortion, both corner fit and 2D keystone functions should be used in conjunction to achieve the best picture shape.

To achieve the best picture shape:

- When installing the projector, align the projector to the screen so they are as perpendicular to each other as possible in order to minimize picture distortion.
- When making corner fit adjustments, if the desired effect cannot be achieved, adjust the 2D keystone value and try again.
- When making 2D keystone adjustments, if the desired effect cannot be achieved, adjust the corner fit value and try again.

Using the menus

The projector is equipped with On-Screen Display (OSD) menus for making various adjustments and settings.

Below is the overview of the OSD menu.



To use the OSD menus, please set them to your familiar language first.

1. Press **MODE/ENTER** on the projector or remote control to turn the OSD menu on.
3. Press **▼** to highlight **Language** and press **◀/▶** to select a preferred language.



2. Use **◀/▶** to highlight the **System Setup: Basic** menu.
4. Press **MODE/ENTER** twice* on the projector or remote control to leave and save the settings.

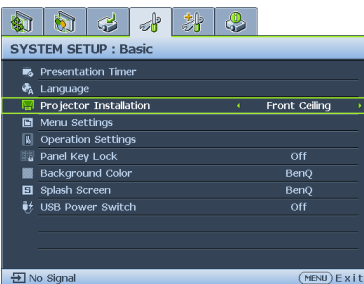

*The first press leads you back to the main menu and the second press closes the OSD menu.

Securing the projector

Using a security cable lock

The projector has to be installed in a safe place to prevent theft. Otherwise, purchase a lock, such as a Kensington lock, to secure the projector. You can locate a Kensington lock slot on the left side of the projector. See "[Kensington anti-theft lock slot](#)" on page 9 for details.

A Kensington security cable lock is usually a combination of key(s) and a lock. Refer to the lock's documentation for finding out how to use it.

Utilizing the password function

For security purposes and to help prevent unauthorized use, the projector includes an option for setting up password security. The password can be set through the On-Screen Display (OSD) menu.

 **WARNING:** You will be inconvenienced if you activate the power-on lock functionality and subsequently forget the password. Print out this manual (if necessary) and write the password you used in this manual, and keep the manual in a safe place for later recall.

Setting a password

 Once a password has been set, the projector cannot be used unless the correct password is entered every time the projector is started.

1. Open the OSD menu and go to the **System Setup: Advanced > Security Settings** menu. Press **MODE/ENTER**. The **Security Settings** page displays.
2. Highlight **Change Security Settings** and press **MODE/ENTER**.
3. As pictured to the right, the four arrow keys (**▲/▼/◀/▶**) respectively represent 4 digits (1, 2, 3, 4). According to the password you desire to set, press the arrow keys to enter five digits for the password.
4. Confirm the new password by re-entering the new password.

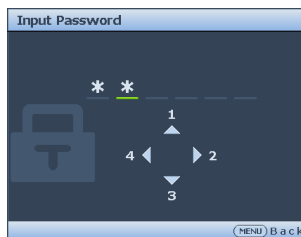

- Once the password is set, the OSD menu returns to the **Security Settings** page.
5. To activate the **Power on Lock** function, press **▲/▼** to highlight **Power on Lock** and press **◀/▶** to select **On**.
 6. To activate the **Web Control Lock** function, press **▲/▼** to highlight **Web Control Lock** and press **◀/▶** to select **On**.
- When the **Web Control Lock** is activated, you have to enter the correct password to change projector settings via the Projector Network Display System.

 The digits being input will display as asterisks on-screen. Write your selected password down here in this manual in advance or right after the password is entered so that it is available to you should you ever forget it.

Password: _ _ _ _ _

Keep this manual in a safe place.

7. To leave the OSD menu, press **MENU/EXIT**.

If you forget the password

If the password function is activated, you will be asked to enter the five-digit password every time you turn on the projector. If you enter the wrong password, the password error message as pictured to the right displays lasting for three seconds, and the message '**INPUT PASSWORD**' follows. You can retry by entering another five-digit password, or if you did not record the password in this manual, and you absolutely do not remember it, you can use the password recall procedure. See "[Entering the password recall procedure](#)" on page 32 for details.

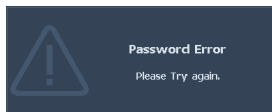

If you enter an incorrect password 5 times in succession, the projector will automatically shut down in a short time.

Entering the password recall procedure

1. Press and hold **AUTO** on the projector or remote control for 3 seconds. The projector will display a coded number on the screen.
2. Write down the number and turn off your projector.
3. Seek help from the local BenQ service center to decode the number. You may be required to provide proof of purchase documentation to verify that you are an authorized user of the projector.

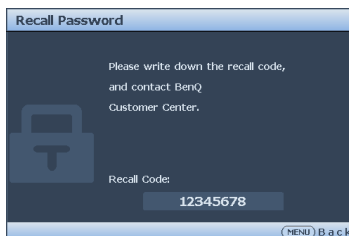

Changing the password

1. Open the OSD menu and go to the **System Setup: Advanced > Security Settings > Change password** menu.
2. Press **MODE/ENTER**. The message '**INPUT CURRENT PASSWORD**' displays.
3. Enter the old password.
 - If the password is correct, another message '**INPUT NEW PASSWORD**' displays.
 - If the password is incorrect, the password error message displays lasting for three seconds, and the message '**INPUT CURRENT PASSWORD**' displays for your retry. You can press **MENU/EXIT** to cancel the change or try another password.
4. Enter a new password.

 The digits being input will display as asterisks on-screen. Write your selected password down here in this manual in advance or right after the password is entered so that it is available to you should you ever forget it.

Password: _ _ _ _ _

Keep this manual in a safe place.

5. Confirm the new password by re-entering the new password.

6. You have successfully assigned a new password to the projector. Remember to enter the new password next time the projector is started.
7. To leave the OSD menu, press **MENU/EXIT**.

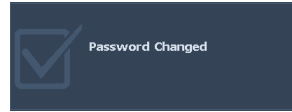

Disabling the password function

To disable password protection, go back to the **System Setup: Advanced > Security Settings > Change Security Settings** menu after opening the OSD menu system. Press **MODE/ENTER**. The message "INPUT PASSWORD" appears. Enter the current password.

1. If the password is correct, the OSD menu returns to the **Security Settings**. Press **▼** highlight **Power On Lock** and press **◀/▶** to select **Off**. You will not have to enter the password next time you turn on the projector. Press **▼** to highlight **Web Control Lock** and press **◀/▶** to select **Off**. The **Web Control Lock** function is released and the projector settings can be change via the Projector Network System.
2. If the password is incorrect, the password error message displays lasting for three seconds, and the message 'INPUT PASSWORD' displays for your retry. You can press **MENU/EXIT** to cancel the change or try another password.

 Though the password function is disabled, you need to keep the old password in hand should you ever need to re-activate the password function by entering the old password.

Switching input signal

The projector can be connected to multiple devices at the same time. However, it can only display one full screen at a time.

Be sure the **Quick Auto Search** function in the **Source** menu is **On** (which is the default of this projector) if you want the projector to automatically search for the signals.

You can also manually cycle through the available input signals.

1. Press **SOURCE** on the projector or press input source directly from the remote control. A source selection bar displays.
2. Press **▲/▼** until your desired signal is selected and press **MODE/ENTER**. Once detected, the selected source information will display on the screen for seconds. If there is multiple equipment connected to the projector, repeat steps 1-2 to search for another signal.

-  • The brightness level of the projected image will change accordingly when you switch between different input signals. Data (graphic) "PC" presentations using mostly static images are generally brighter than "Video" using mostly moving images (movies).
- For best display picture results, you should select and use an input signal which outputs at this resolution. Any other resolutions will be scaled by the projector depending upon the 'aspect ratio' setting, which may cause some image distortion or loss of picture clarity. See "[Selecting the aspect ratio](#)" on page 35 for details.

Changing Color Space

If in the unlikely event that you connect the projector to a DVD player via the projector's **HDMI** input and the projected picture displays wrong colors, please change the color space.

To do this:

1. Press **MENU/EXIT** and then press **◀/▶** until the **SOURCE** menu is highlighted.
2. Press **▼** to highlight **Color Space Conversion** and press **◀/▶** to select the setting.

 This function is only available when the HDMI input socket is in use.

Magnifying and searching for details

If you need to find the details on the projected picture, magnify the picture. Use the direction arrow keys for navigating the picture.

- Using the remote control
 1. Press **Digital Zoom+/-** to display the Zoom bar. Press **Digital Zoom+** to magnify the center of the picture. Press the key repeatedly until the picture size is suitable for your need.
 2. Use the directional arrows (**▲/▼/◀/▶**) on the projector or remote control to navigate the picture.
 3. To restore the picture to its original size, press **AUTO**. You can also press **Digital Zoom-**. When the key is pressed again, the picture is further reduced until it is restored to the original size.
- Using the OSD menu
 1. Press **MENU/EXIT** and then press **◀/▶** until the **Display** menu is highlighted.
 2. Press **▼** to highlight **Digital Zoom** and press **MODE/ENTER**. The Zoom bar displays.
 3. Press **▼** on the projector repeatedly to magnify the picture to a desired size.
 4. To navigate the picture, press **MODE/ENTER** to switch to the panning mode and press the directional arrows (**▲/▼/◀/▶**) to navigate the picture.
 5. To reduce size of the picture, press **MODE/ENTER** to switch back to the zoom in/out functionality, and press **AUTO** to restore the picture to its original size. You can also press **▼** repeatedly until it is restored to the original size.

 The picture can only be navigated after the picture is magnified. You can further magnify the picture while searching for details.

Selecting the aspect ratio

The 'aspect ratio' is the ratio of the image width to the image height. Most analog TV and computers are in 4:3 ratio, and digital TV and DVDs are usually in 16:9 ratio.

With the advent of digital signal processing, digital display devices like this projector can dynamically stretch and scale the image output to a different aspect than that of the image input signal.

To change the projected image ratio (no matter what aspect the source is):

- Using the remote control
 1. Press **Aspect** to show the current setting.
 2. Press **Aspect** repeatedly to select an aspect ratio to suit the format of the video signal and your display requirements.
- Using the OSD menu
 1. Press **MENU/EXIT** and then press ◀/▶ until the **Display** menu is highlighted.
 2. Press ▼ to highlight **Aspect Ratio**.
 3. Press ◀/▶ to select an aspect ratio to suit the format of the video signal and your display requirements.

About the aspect ratio

 In the pictures below, the black portions are inactive areas and the white portions are active areas. OSD menus can be displayed on those unused black areas.

1. **Auto:** Scales an image proportionally to fit the projector's native resolution in its horizontal width. This is suitable for the incoming image which is neither in 4:3 nor 16:9 and you want to make most use of the screen without altering the image's aspect ratio.

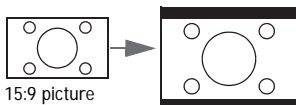

2. **Real:** The image is projected as its original resolution, and resized to fit within the display area. For input signals with lower resolutions, the projected image will display smaller than if resized to full screen. You could move the projector away from the screen to increase the image size if necessary. You may also need to refocus the projector after making these adjustments.

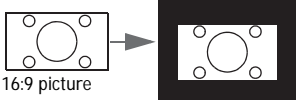
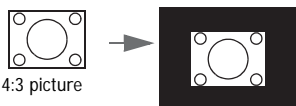

3. **4:3:** Scales an image so that it is displayed in the center of the screen with a 4:3 aspect ratio. This is most suitable for 4:3 images like computer monitors, standard definition TV and 4:3 images aspect DVD movies, as it displays them without aspect alteration.

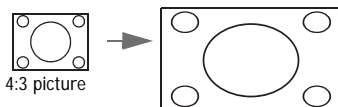

4. **16:6:** Scales an image so that it is displayed in the center of the screen with a 16:6 aspect ratio. (Available in MH856UST)

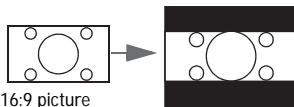

5. **16:9:** Scales an image so that it is displayed in the center of the screen with a 16:9 aspect ratio. This is most suitable for images which are already in a 16:9 aspect, like high definition TV, as it displays them without aspect alteration.

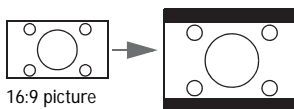

6. **16:10:** Scales an image so that it is displayed in the center of the screen with a 16:10 aspect ratio. This is most suitable for images which are already in a 16:10 aspect, as it displays them without aspect alteration.

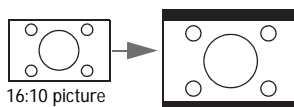

Optimizing the image

Using Wall Color

In the situation where you are projecting onto a colored surface such as a painted wall which may not be white, the **Wall Color** feature can help correct the projected picture's color to prevent possible color difference between the source and projected pictures.

To use this function, go to the **Display > Wall Color** menu and press ◀/▶ to select a color which is the closest to the color of the projection surface. There are several precalibrated colors to choose from: **Light Yellow, Pink, Light Green, Blue,** and **Blackboard**.

Selecting a picture mode

The projector is preset with several predefined picture modes so that you can choose one to suit your operating environment and input signal picture type.

To select an operation mode that suits your need, you can follow one of the following steps.

- Press **MODE/ENTER** on the projector repeatedly until your desired mode is selected.
- Go to the **Picture > Picture Mode** menu and press ◀/▶ to select a desired mode.
 1. **Bright mode:** Maximizes the brightness of the projected image. This mode is suitable for environments where extra-high brightness is required, such as using the projector in well lit rooms.
 2. **Presentation mode:** Is designed for presentation. The brightness is emphasized in this mode to match PC and notebook coloring..
 3. **sRGB mode:** Maximizes the purity of RGB colors to provide true-to-life images regardless of brightness setting. It is most suitable for viewing photos taken with an sRGB compatible and properly calibrated camera, and for viewing PC graphic and drawing applications such as AutoCAD.
 4. **Vivid mode:** This is suitable for displaying colorful video and pictures with wellbalanced color saturation and high color brightness.
 5. **Infographic mode:** Is perfect for presentations with the mixture of text and graphics due to its high color brightness and better color gradation to see the details clearly.
 6. **3D mode:** Is appropriate for playing 3D images and 3D video clips.
 7. **User 1/User 2 mode:** Recalls the settings customized based on the current available picture modes. See "[Setting the User 1/User 2 mode](#)" on page 38 for details.

Setting the User 1/User 2 mode

There are two user-definable modes if the current available picture modes are not suitable for your need. You can use one of the picture modes (except the **User 1/User 2**) as a starting point and customize the settings.

1. Press **MENU/EXIT** to open the On-Screen Display (OSD) menu.
2. Go to the **Picture > Picture Mode** menu.
3. Press **◀/▶** to select **User 1 to User 2**.
4. Press **▼** to highlight **Reference Mode**.

 This function is only available when User 1 or User 2 mode is selected up in the Picture Mode sub-menu item.

5. Press **◀/▶** to select a picture mode that is closest to your need.
6. Press **▼** to select a sub-menu item to be changed and adjust the value with **◀/▶**. See "[Fine-tuning the image quality in user modes](#)" below for details.

Fine-tuning the image quality in user modes

According to the detected signal type, and selected picture mode, some of the functions listed below may not be available. Base on your need, you can make adjustments to these functions by highlighting them and press **◀/▶** on the projector or remote control.

Adjusting Brightness

The higher the value, the brighter the image. And lower the setting, darker the image. Adjust this control so the black areas of the image appear just as black and that detail in the dark areas is visible.



Adjusting Contrast

The higher the value, the greater the contrast. Use this to set the peak white level after you have previously adjusted the **Brightness** setting to suit your selected input and viewing environment.



Adjusting Color

Lower setting produces less saturated colors. If the setting is too high, colors on the image will be overpowering, which makes the image unrealistic.

Adjusting Tint

The higher the value, the more reddish the picture becomes. The lower the value, the more greenish the picture becomes.

Adjusting Sharpness

The higher the value, the sharper the picture becomes. The lower the value, the softer the picture becomes.

Adjusting Brilliant Color

This feature utilizes a new color-processing algorithm and system level enhancements to enable higher brightness while providing truer, more vibrant colors in picture. It enables a greater than 50% brightness increase in mid-tone images, which are common in video and natural scenes, so the projector reproduces images in realistic and true colors. If you prefer images with that quality, select **On**. If you don't need it, select **Off**.

When **Off** is selected, the **Color Temperature** function is not available.

Selecting a Color Temperature

The options available for color temperature* settings vary according to the signal type selected.

1. **Cooler:** makes the image appear bluish white.
2. **Normal:** Maintains normal colorings for white.
3. **Warm:** Makes images appear reddish white.

*About color temperatures:

There are many different shades that are considered to be "white" for various purposes. One of the common methods of representing white color is known as the "color temperature". A white color with a low color temperature appears to be reddish white. A white color with a high color temperature appears to have more blue in it.

Setting a preferred color temperature

To set a preferred color temperature:

1. Highlight **Color Temperature** and select **Warm, Normal** or **Cool** by pressing ◀/▶ on the projector or remote control.
2. Press ▼ to highlight **Color Temperature Fine Tuning** and press **MODE/ENTER**. The Color Temperature Fine Tuning page appears.
3. Press ▲/▼ to highlight the item you want to change and adjust the values by pressing ◀/▶ .
 - **R Gain/G Gain/B Gain:** Adjusts the contrast levels of Red, Green, and Blue.
 - **R Offset/G Offset/B Offset:** Adjusts the brightness levels of Red, Green, and Blue.
4. Press **MENU/EXIT** to exit and save the settings

3D Color Management

In most installation situations, color management will not be necessary, such as in classroom, meeting room, or lounge room situations where lights remain on, or where building external windows allow daylight into the room.

Only in permanent installations with controlled lighting levels such as boardrooms, lecture theaters, or home theaters, should color management be considered. Color management provides fine color control adjustment to allow for more accurate color reproduction, should you require it.

Proper color management can only be achieved under controlled and reproducible viewing conditions. You will need to use a colorimeter (color light meter), and provide a set of suitable source images to measure color reproduction. These tools are not provided with the projector, however, your projector supplier should be able to provide you with suitable guidance, or even an experienced professional installer.

The Color Management provides six sets (RGBCMY) of colors to be adjusted. When you select each color, you can independently adjust its range and saturation according to your preference.

If you have purchased a test disc which contains various color test patterns and can be used to test the color presentation on monitors, TVs, projectors, etc. You can project any image from the disc on the screen and enter the **3D Color Management** menu to make adjustments.

To adjust the settings:

1. Go to the **Picture** menu and highlight **3D Color Management**.
2. Press **MODE/ENTER** and the **3D Color Management** page displays.
3. Highlight **Primary color** and press **◀/▶** to select a color from among Red, Green, Blue, Cyan, Magenta and Yellow.
4. Press **▼** to highlight **Hue** and press **◀/▶** to select its range. Increase in the range will include colors consisted of more proportions of its two adjacent colors.

Please refer to the illustration to the right for how the colors relate to each other.

For example, if you select Red and set its range at 0, only pure red in the projected picture will be selected. Increasing its range will include red close to yellow and red close to magenta.

5. Press **▼** to highlight **Saturation** and adjust its values to your preference by pressing **◀/▶**. Every adjustment made will reflect to the image immediately.

For example, if you select Red and set its value at 0, only the saturation of pure red will be affected.

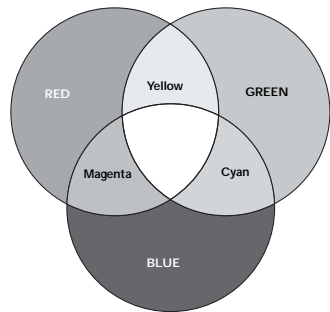

Hand icon **Saturation** is the amount of that color in a video picture. Lower settings produce less saturated colors; a setting of "0" removes that color from the image entirely. If the saturation is too high, that color will be overpowering and unrealistic.

6. Press **▼** to highlight **Gain** and adjust its values to your preference by pressing **◀/▶**. The contrast level of the primary color you select will be affected. Every adjustment made will reflect to the image immediately.
7. Repeat steps 3 to 6 for other color adjustments.

8. Make sure you have made all of the desired adjustments.
9. Press **MENU/EXIT** to exit and save the settings.

Resetting current or all picture modes

1. Go to the **Picture** menu and highlight **Reset Picture Settings**.
2. Press **MODE/ENTER** and press **◀/▶** to select **Current** or **All**.
 - **Current**: returns current picture mode to the factory preset settings.
 - **All**: returns all settings, except **User 1/User 2** in the **Picture** menu to the factory preset settings.

Setting the presentation timer

Presentation timer can indicate the presentation time on the screen to help you achieve better time management when giving presentations. Follow these steps to utilize this function:

1. Go to the **System Setup: Basic > Presentation Timer** menu and press **MODE/ENTER** to display the **Presentation Timer** page.
2. Highlight **Timer Period** and decide the time period by pressing **◀/▶**. The length of time can be set from 1 to 5 minutes in 1-minute increments and 5 to 240 minutes in 5-minute increments.

 If the timer is already on, the timer will restart whenever the **Timer Period** is reset.

3. Press **▼** to highlight **Timer Display** and choose if you want the timer to show up on the screen by pressing **◀/▶**.

Selection	Description
Always	Displays the timer on screen throughout the presentation time.
3 min/2 min/1 min	Displays the timer on screen in the last 3/2/1 minute(s).
Never	Hides the timer throughout the presentation time.

4. Press **▼** to highlight **Timer Position** and set the timer position by pressing **◀/▶**.
5. Press **▼** to highlight **Timer Counting Direction** and select your desired counting direction by pressing **◀/▶**.

Selection	Description
Count Up	Increases from 0 to the preset time.
Count Down	Decreases from the preset time to 0.

6. Press **▼** to highlight **Sound Reminder** and decide if you want to activate sound reminder by pressing **◀/▶**. If you select **On**, a double beep sound will be heard at the last 30 seconds of counting down/up, and a triple beep sound will be produced when the timer is up.
7. To activate the presentation timer, press **▼** and press **◀/▶** to highlight **On** and press **MODE/ENTER**.
8. A confirmation message appears. Highlight **Yes** and press **MODE/ENTER** on the projector or remote control to confirm. You will see the message "**Timer is On**" appearing on the screen. The timer starts counting when the timer is on.

 If **Presentation Timer** is activate, then "**On**" will change to "**Reset**".

To cancel the timer, perform the following steps:

1. Go to the **System Setup: Basic > Presentation Timer** menu and highlight **Off**. Press **MODE/ENTER**. A confirmation message appears.
2. Highlight **Yes** and press **MODE/ENTER** to confirm. You will see the message "Timer is Off" appearing on the screen.

Remote paging operations

Connect the projector to your PC or notebook with a USB cable prior to using the paging function. See "[Connection](#)" on page 23 for details.

You can operate your display software program (on a connected PC) which responds to page up/down commands (like Microsoft PowerPoint) by pressing **PAGE +/PAGE -** on the remote control.

If remote paging function doesn't work, check if the USB connection is correctly made and the mouse driver on your computer is updated to the latest version.

 The remote paging function cannot work with Microsoft® Windows® 98 operating system. Windows® XP or higher operating systems are recommended.

Freezing the image

Press **FREEZE** on the remote control to freeze the image. The word '**FREEZE**' will appear on the screen. To release the function, press any key on the projector or remote control.

 If your remote control has the following keys, please note that they cannot be pressed to release the function: **LASER, #2, #5, PAGE +/PAGE -**.

Even if an image is frozen on the screen, the pictures are running on the video or other device. If the connected devices have active audio output, you will still hear the audio even though the image is frozen on screen.

Hiding the image

In order to draw the audience's full attention to the presenter, you can use **ECO BLANK** on the remote control to hide the screen image. When the function is activated with an audio input connected, the audio can still heard.

You can set the blank time in the **System Setup: Basic > Operating Settings > Blank Timer** menu to let the projector return the image automatically after a period of time when there is no action taken on the blank screen. The length of time can be set from 5 to 30 minutes in 5-minute increments.



If the preset time spans are not suitable for your presentation, select **Disable**.



No matter **Blank Timer** is activated or disabled, you can press most of the keys on the projector or remote control to restore the picture.

 **Do not block the projection lens from projecting as this could cause the blocking object to become heated and deformed or even cause a fire.**

Locking control keys

With the control keys on the projector locked, you can prevent your projector settings from being changed accidentally (by children, for example). When the **Panel Key Lock** is on, no control keys on the projector will operate except  **POWER**.

1. Go to the **System Setup: Basic > Panel Key Lock** menu, and select **On** by pressing   on the projector or remote control. A confirmation message appears.
2. Highlight **Yes** and press **MODE/ENTER** to confirm.

To release panel key lock, use the remote control to enter the **System Setup: Basic > Panel Key Lock** menu and press   to select **Off**.



• **Keys on the remote control are still active when panel key lock is enabled.**

- If you press  **POWER** to turn off the projector without disabling panel key lock, the projector will still be in locked status the next time it is turned on.





Operating in a high altitude environment

We recommend you use the **High Altitude Mode** when your environment is between 1500 m –3000 m above sea level, and temperature is between 0°C–30°C.



Do not use the High Altitude Mode if your altitude is between 0 m and 1500 m and temperature is between 0°C and 35°C. The projector will be over cooled, if you turn the mode on under such a condition.

To activate the **High Altitude Mode**:

1. Press **MENU/EXIT** and then press   until the **System Setup: Advanced** menu is highlighted.
2. Press  to highlight **High Altitude Mode** and press   to select **On**. A confirmation message displays.
3. Highlight **Yes** and press **MODE/ENTER**.

Operation under "**High Altitude Mode**" may cause a higher decibel operating noise level because of increased fan speed necessary to improve overall system cooling and performance.

If you use this projector under other extreme conditions excluding the above, it may display auto shut-down symptoms, which is designed to protect your projector from over-heating. In cases like this, you should switch to High Altitude mode to solve these symptoms. However, this is not to state that this projector can operate under any and all harsh or extreme conditions.

Adjusting the sound

The sound adjustments made as below will have an effect on the projector speakers. Be sure you have made a correct connection to the projector audio input. See "[Connection](#)" on page 23 for how the audio input is connected.

INPUT SOURCE	AUDIO IN	AUDIO OUT
Computer	mini jack	mini jack
HDMI	HDMI	mini jack
VIDEO	RCA	mini jack

Muting the sound

To temporarily turn off the sound,

- Using the remote control

Press **MUTE** to temporarily turn off the sound. While the sound is off, the screen will display  in the upper right corner of the screen.

To restore the sound, press **MUTE** again.

- Using the OSD menu

1. Press **MENU/EXIT** and then press **◀/▶** until the **System Setup: Advanced** menu is highlighted.
2. Press **▼** to highlight **Audio Settings** and press **MODE/ENTER**. The **Audio Settings** page displays.
3. Highlight **Mute** and press **◀/▶** to select **On**.
4. To restore the sound, repeat steps 1-3 and press **◀/▶** to select **Off**.

Adjusting the sound level

To adjust the sound level,

- Using the remote control

Press  or  to select a desired sound level.

- Using the OSD menu

1. Repeat steps 1-2 above.
2. Press **▼** to highlight **Volume** and press **◀/▶** to select a desired sound level.

Turning off the power on/off ring tone

1. Repeat steps 1-2 above.
2. Press **▼** to highlight **Power On/Off Ring Tone** and press **◀/▶** to select **Off**.

The only way to change Power On/Off Ring Tone is setting On or Off here. Setting the sound mute or changing the sound level will not affect the Power On/Off Ring Tone.

Using the test pattern

The projector is capable of displaying the grid test pattern. It can be used to assist you with the adjustment of image size and focus, ensuring that the projected image is free from distortion.

To display the test pattern, open the OSD menu and go to the **System Setup: Advanced > Test Pattern** and press **▼** to select **On**.

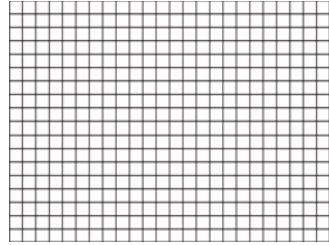

Using the teaching templates

The projector provides several preset patterns for various teaching purposes. To activate the pattern:

1. Open the OSD menu and go to the **Display > Teaching Template** and press **▲/▼** to select **Blackboard** or **Whiteboard**.
2. Press **◀/▶** to choose the pattern you need.
3. Press **MODE/ENTER** to activate the pattern.

Teaching Template	Whiteboard	Blackboard
Letter Formation		
Worksheet		
Coordinate Chart		

Controlling the projector through a wired LAN environment

Wired LAN allows you to manage the projector from a computer using a web browser when the computer and the projector are properly connected to the same local area network.

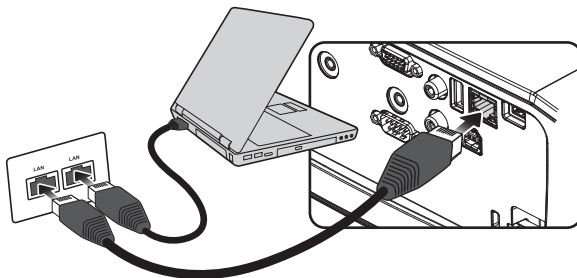

Configuring the wired LAN

If you are in a DHCP environment:

1. Take a RJ45 cable and connect one end to the RJ45 LAN input jack of the projector and the other end to the RJ45 port.

 When connecting the RJ45 cable, avoid coiling and intertwining the cable as it may cause signal noise or interruption.

2. Press **MODE/ENTER** and then press **◀/▶** until the **System Setup: Advanced** menu is highlighted.
3. Press **▼** to highlight **Network Settings** and press **MODE/ENTER**. The **Network Settings** page is displayed.
4. Press **▼** to highlight **Wired LAN** and press **MODE/ENTER**. The **Wired LAN** page is displayed.
5. Press **▼** to highlight **DHCP** and press **◀/▶** to select **On**.
6. Please wait for around 15 - 20 seconds, and then re-enter the **Wired LAN** page.
7. The **IP Address**, **Subnet Mask**, **Default Gateway**, and **DNS Server** settings will be displayed. Note down the IP address displayed in the **IP Address** row.

Wired LAN	
Status	Connect
DHCP	On
IP Address	10.82.30.156
Subnet Mask	255.255.255.0
Default Gateway	10.82.159.254
DNS Server	10.82.131.12
Apply	

 If the IP Address still does not display, contact your ITS administrator.

8. Go back to **System Setup: Advanced > Network Settings** page.
9. Press **▼** to highlight **AMX Device Discovery** and press **◀/▶** to select **On** or **Off**. When **AMX Device Discovery** is **On**, the projector can be detected by AMX controller.

If you are in a non-DHCP environment:

1. Repeat steps 1-4 above.
2. Press ▼ to highlight **DHCP** and press ◀/▶ to select **Off**.
3. Contact your ITS administrator for information on the **IP Address**, **Subnet Mask**, **Default Gateway**, and **DNS Server** settings.
4. Press ▼ to select the item you want to modify and press **MODE/ENTER**.

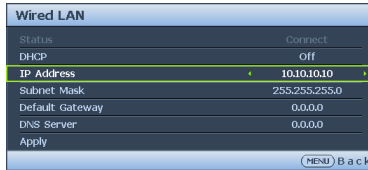

5. Press ◀/▶ to move the cursor and then press ▲/▼ to enter the value.



6. To save the setting, press **MODE/ENTER**. If you do not want to save the setting, press **MENU/EXIT**.
7. Press ▼ to highlight **Apply** and press **MODE/ENTER**.
8. Press **MENU/EXIT** to return to **Network Settings** page, press ▼ to highlight **AMX Device Discovery** and press ◀/▶ to select **On** or **Off**.
9. Press **MENU/EXIT** to exit the menu.

Controlling the projector remotely through a web browser

Once you have the correct IP address for the projector and the projector is on or in standby mode, you can use any computer that is on the same local area network to control the projector.

1. Enter the address of the projector in the address bar of your browser and click **Go**.

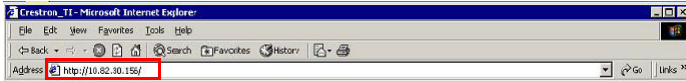

2. The remote network operation page opens. This page (Crestron eControl) allows you to operate the projector as if you were using the remote control or control panel on the projector.



1	To switch input source, click on your desired signal.	 The source list varies according to the connectors available on the projector. "Video" stands for the Video signal.
2	Menu Auto PC Blank Input ▲ (▼) ▼ (▲) ◀ (▶) ▶ (◀)	See "Remote Control" on page 12 for details.
	OK	Activates the selected On-Screen Display (OSD) menu item.

The tools page allows you to manage the projector, configure the LAN control settings and secure access of remote network operation on this projector.

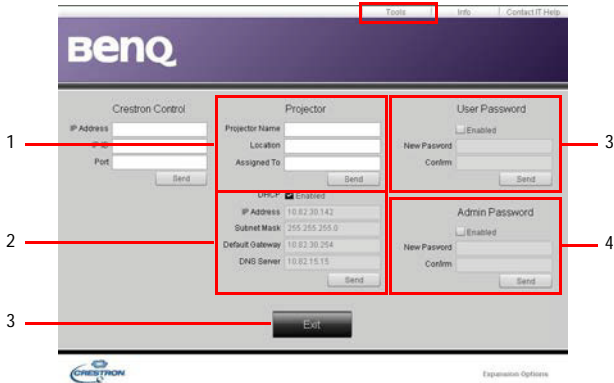

1. You can name the projector, keep track of its location and the person in charge of it.
2. You can adjust the **LAN Control Settings**.
3. Once set, access to the remote network operation on this projector has been password protected.
4. Once set, access to the tools page has been password-protected.
5. Press **Exit** to go back to the remote network operation page.

 After making the adjustments, press the Send button and the data will be saved in the projector.

Please pay attention to the limitation of input length (including space and other punctuation keys) in the list blow:

Category item	Input length	Maximum number of characters
Crestron Control	IP Address	15
	IP ID	4
	Port	5
Projector	Projector Name	22
	Location	22
	Assigned To	N/A
Network Configuration	DHCP (Enabled)	15
	IP Address	15
	Subnet Mask	15
	Default Gateway	15
	DNS Server	N/A
User Password	Enabled	N/A
	New Password	15
	Confirm	15
Admin Password	Enabled	N/A
	New Password	15
	Confirm	15

The info page displays the information and status of this projector.

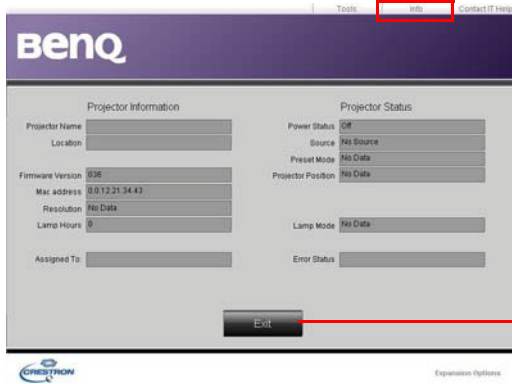

Press **Exit** to go back to the remote network operation page.

For more information, visit <http://www.crestron.com> & www.crestron.com/getroomview.

Installing PointWrite module on projector to use interaction function

You can install a PointWrite module (PW30U, an optional accessory sold independently) on the projector to start the interactive function.

Camera installation on projector

Make sure the PointWrite camera is installed properly before you active interactive function.

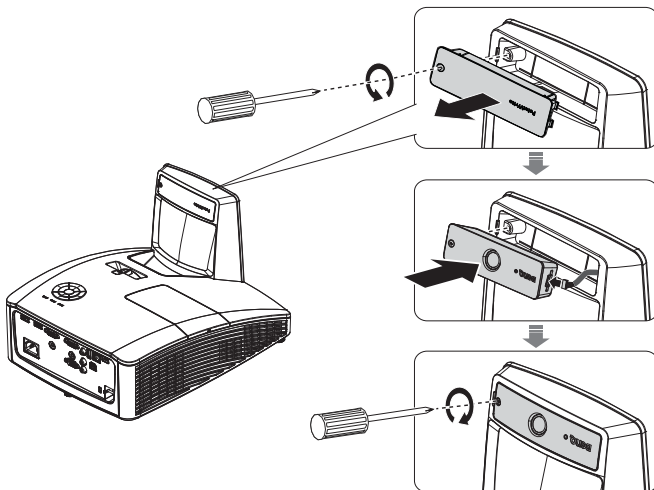

Use the USB cable to connect the projector to PC. Plug the USB mini-B end into the projector and plug the USB type-A end into PC.

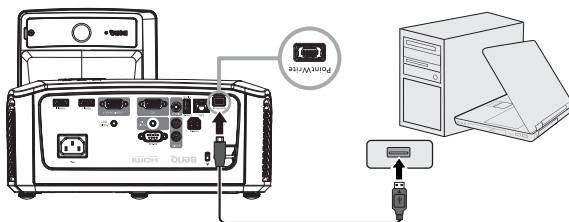

Check **Device Manager** from your computer to make sure that PointWrite device is recognized by your computer.

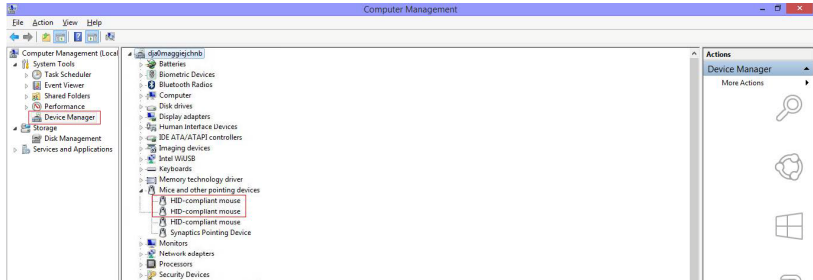

When finishing the PointWrite module installation, please refer to the PW30U user manual for further instruction.

Shutting down the projector

1. Press **POWER** or **OFF** and a confirmation message will appear prompting you.
If you don't respond in a few seconds, the message will disappear.
2. Press **POWER** or **OFF** a second time. The **POWER indicator light** flashes orange, the projection lamp shuts down, and the fans will continue to run for approximately 90 seconds to cool down the projector.

 **To protect the lamp, the projector will not respond to any commands during the cooling process. To shorten the cooling time, you can also activate the Quick Cooling function. See "Quick Cooling" on page 62 for details.**

3. Once the cooling process finishes, a "**Power Off Ring Tone**" will be heard. The **POWER indicator light** is a steady orange and fans stop. Disconnect the power cord from the power outlet.

 **To turn off the power ring tone, see "Turning off the power on/off ring tone" on page 44 for details.**

- If the projector is not properly shut down, to protect the lamp, when you attempt to re-start the

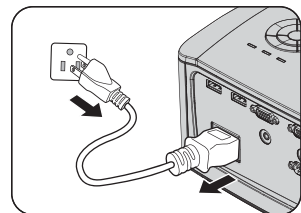

projector, the fans will run for a few minutes to cool down. Press **POWER** or **ON** again to start the projector after the fans stop and the **POWER indicator light** turns orange.

- **Lamp life results will vary depending on environmental conditions and usage.**

Menu operation

Menu system

Please note that the on-screen display (OSD) menus vary according to the signal type selected.

Main menu	Sub-menu	Options	
1. Display	Wall Color	Off/Light Yellow/Pink/Light Green/Blue/Blackboard	
	Aspect Ratio	Auto/Real/4:3/*16:6/16:9/16:10	
	2D Keystone		
	Corner Fit	Top Left/Top Right/Bottom Left/Bottom Right	
	Position		
	Phase		
	H.Size		
	Digital Zoom	PC:1.0X~2.0X; Video: 1.0X~1.8X	
	Digital Shrink & Shift	Digital Shrink/Digital Image Shift	
	3D	3D Mode	Auto/Off/Frame Sequential/Frame Packing/Top Bottom/Side by Side
		3D Sync Invert	Disable/Invert
		Save 3D Settings	3D Settings 1/3D Settings 2/3D Settings 3
		Apply 3D Settings	3D Settings 1/3D Settings 2/3D Settings 3/Off
	Teaching Template	Blackboard	Off/Letter Formation/Worksheet/Coordinate Chart
Whiteboard		Off/Letter Formation/Worksheet/Coordinate Chart	

*16:6: Available in MH856UST+.

Main menu	Sub-menu	Options	
2. Picture	Picture Mode	Bright/Presentation/sRGB/Vivid/Infographic/(3D)/User 1/User 2	
	Reference Mode	Bright/Presentation/sRGB/Vivid/Infographic/(3D)	
	Brightness		
	Contrast		
	Color		
	Tint		
	Sharpness		
	Brilliant Color	On/Off	
	Color Temperature	Cool/Normal/Warm	
	Color Temperature Fine Tuning	R Gain/G Gain/B Gain/R Offset/G Offset/B Offset	
	3D Color Management	Primary Color	R/G/B/C/M/Y
		Hue	
		Saturation	
		Gain	
Reset Picture Settings	Current/All/Cancel		
3. Source	Quick Auto Search	On/Off	
	HDMI Format	Auto/RGB Limited/ RGB Full/ YUV Limited/ YUV Full	
	HDMI EDID	HDMI-1/HDMI-2 Enhanced/ Standard	
	HDMI Equalizer	HDMI-1/HDMI-2 Auto/Lower/Low/Middle/High/Higher	

Main menu	Sub-menu	Options	
	Presentation Timer	Timer Period	1~240 min
		Timer Display	Always/1 min/2mins/3 mins/Never
		Timer Position	Top-Left/Bottom-Left/Top-Right/Bottom-Right
		Timer Counting Direction	Count Down/Count up
		Sound Reminder	On/Off
		On (Reset)	Yes/No
		Off	Yes/No
	Language	English / Français / Deutsch / Italiano / Español / Русский / 繁體中文 / 简体中文 / 日本語 / 한국어 / Svenska / Nederlands / Türkçe / Čeština / Português / हिन्दी / Polski / Magyar / Hrvatski / Română / Norsk / Dansk / Български / Suomi / Indonesian / Ελληνικό / العربية / हिन्दी	
4. System Setup: Basic	Projector Installation	Front Table/Rear Table/Rear Ceiling/Front Ceiling	
	Menu Settings	Menu Display Time	5 sec/10 sec/20 sec/30 sec/Always
Menu Position		Center/Top-Left/Top-Right/Bottom-Right/Bottom-Left	
Reminder Message		On/Off	
Operation Settings	Direct Power On	On/Off	
	Signal Power On	Computer/HDMI	
	Auto Power Off	Disable/3 mins/10 mins/15 mins/20 mins/25 mins/30 mins	
	Quick Cooling	On/Off	
	Instant Restart	On/Off	
	Blank Timer	Disable/5 mins/10 mins/15 mins/20 mins/25 mins/30 mins	
	Sleep Timer	Disable/30 mins/1 hr/2 hrs/3hrs/4hrs/8 hrs/12hrs	
	Panel Key Lock	On/Off	
	Background Color	BenQ/Black/Blue/Purple	
	Splash Screen	BenQ/Black/Blue	
	USB Power Switch	On/Off	

Main menu	Sub-menu	Options
	High Altitude Mode	On/Off
	Mute	On/Off
	Volume	
	Audio Settings	Power On/Off Ring Tone
	Light Mode	Normal/Economic/SmartEco/LampSave
	Reset Light Timer	Reset / Cancel
	Light Settings	Light Usage Time (Normal Mode, Economic Mode, SmartEco Mode, LampSave Mode)/Equivalent Light Source Hour
	Change Password	
	Security Setting	Change Security Settings
	Baud Rate	2400/4800/9600/14400/19200/38400/57600/115200
	Test Pattern	On/Off
	Closed Caption Enable	On/Off
	Caption Version	CC1/CC2/CC3/CC4
	Network	Enable Network Standby Mode/Switch To Normal Standby Mode
	Standby Settings	Monitor Out
	Audio Pass Through	Off/AUDIO IN/AUDIO LR/HDMI 1/HDMI 2
		Status
		DHCP
		IP Address
	Wired LAN	Subnet Mask
	Network settings	Default Gateway
		DNS Server
		Apply
	AMX Device Discovery	On/Off
	Mac Address	
	Reset All Settings	Reset/Cancel



5. System Setup: Advanced



Main menu	Sub-menu	Options
6. Information	Current System Status	<ul style="list-style-type: none"> • Native Resolution • Source • Picture Mode • Light Mode • Resolution • 3D Format • Color System • Light Usage Time • Firmware Version

Note that the menu items are available when the projector detects at least one valid signal. If there is no equipment connected to the projector or no signal detected, limited menu items are accessible.



Description of each menu

		FUNCTION	DESCRIPTION	
1. Display menu		Wall Color	Corrects the projected picture's color when the projection surface is not white. See "Using Wall Color" on page 37 for details.	
		Aspect Ratio	There are several options to set the image's aspect ratio depending on your input signal source. See "Selecting the aspect ratio" on page 35 for details.	
		2D Keystone	Adjusts the shape of the projected image to ensure straight lines on all four corners. See "Correcting 2D Keystone" on page 28 for details.	
		Corner Fit	Adjusts the shape of the projected image to ensure a specific corner is straight. See "Correcting Corner Fit" on page 29 for details.	
		Position	Displays the position adjustment page. To move the projected image, use the directional arrow keys. The values shown on the lower position of the page change with every key press you made until they reach their maximum or minimum. This function is only available when a PC signal (analog RGB) is selected.	
		Phase	Adjusts the clock phase to reduce image distortion. This function is only available when a PC signal (analog RGB) is selected.	
		H.Size	Adjusts the horizontal width of the image. This function is only available when a PC signal (analog RGB) is selected.	
		Digital Zoom	Magnifies or reduces the projected image. See "Magnifying and searching for details" on page 34 for details.	
		Digital Shrink & Shift	<p>Digital Shrink Shrinks the image with middle point of the image fixed.</p> <ol style="list-style-type: none"> 1. Press MENU/EXIT and then press ◀/▶ until the DISPLAY menu is selected. Press ▼ to select Digital Shrink & Shift and press MODE/ENTER. 2. Select Digital Shrink and press MODE/ENTER. 3. Press ◀/▶ to reduce the image to a desired size. 4. Press AUTO to restore the picture to its original size. <p>Digital Image Shift After digital shift function is activated,</p> <ol style="list-style-type: none"> 1. Press ▼ to select Digital Image Shift and press MODE/ENTER. 2. Press the directional arrows to shift the image. 3. Press AUTO to restore the picture to its original position. 	



FUNCTION		DESCRIPTION
1. Display menu 3D		<p>This projector features a 3D function which enables you to enjoy the 3D movies, videos, and sporting events in a more realistic way by presenting the depth of the images. You need to wear a pair of 3D glasses to view the 3D images.</p> <p>3D Mode</p> <p>The default setting is Auto and the projector automatically chooses an appropriate 3D format when detecting 3D contents. If the projector cannot recognize the 3D format, press ◀/▶ to choose a 3D mode.</p> <p> When the 3D function is on:</p> <ul style="list-style-type: none"> • The brightness level of the projected image will decrease. • The following settings cannot be adjusted: Picture Mode, Reference Mode. • The Keystone can only be adjusted within limited degrees. <p>3D Sync Invert</p> <p>When you discover the inversion of the image depth, enable this function to correct the problem.</p> <p>Save 3D Settings</p> <p>When you have successfully displayed the 3D contents after making the appropriate adjustments, you can enable this function and choose a set of 3D settings to memorize current 3D settings.</p> <p>Apply 3D Settings</p> <p>After the 3D settings are saved, you can decide if you would like to apply them by choosing a set of 3D settings that you have saved. Once applied, the projector will automatically play the incoming 3D contents if it matches the 3D settings saved.</p> <p> Only the set(s) of 3D settings with memorized data is available.</p>
Teaching Template		See "Using the teaching templates" on page 45 for details.

FUNCTION		DESCRIPTION	
2. Picture menu	Picture Mode	Pre-defined picture modes are provided so you can optimize your projector image set-up to suit your program type. See "Selecting a picture mode" on page 37 for details.	
	Reference Mode	Selects a picture mode that most suits your need for the image quality and further fine-tune the image based on the selections listed on the same page below. See "Setting the User 1/User 2 mode" on page 38 for details.	
	Brightness	Adjusts the brightness of the image. See "Adjusting Brightness" on page 38 for details.	
	Contrast	Adjusts the degree of difference between dark and light in the image. See "Adjusting Contrast" on page 38 for details.	
	Color	Adjusts the color saturation level -- the amount of each color in a video image. See "Adjusting Color" on page 38 for details.  The function is only available when Component, Video or S-Video with NTSC system is selected.	
	Tint	Adjusts the red and green color tones of the image. See "Adjusting Tint" on page 38 for details.  The function is only available when Video with NTSC system is selected.	
	Sharpness	Adjusts the image to make it look sharper or softer. See "Adjusting Sharpness" on page 38 for details.  The function is only available when Component, Video or S-Video with NTSC system is selected.	
	Brilliant Color	Adjusts white peaking while maintaining correct color presentation. See "Adjusting Brilliant Color" on page 38 for details.	
	Color Temperature	See "Selecting a Color Temperature" on page 39 for details.	
	Color Temperature Fine Tuning	See "Setting a preferred color temperature" on page 39 for details.	
	3D Color Management	See "3D Color Management" on page 40 for details.	
	Reset Picture Settings	See "Resetting current or all picture modes" on page 41 for details.	

FUNCTION		DESCRIPTION
3. Source menu	Quick Auto Search	See "Switching input signal" on page 33 for details.
	HDMI Format	<p>Selects a suitable color format to optimize display quality.</p> <p>Auto Automatically selects a suitable color space and gray level for the incoming HDMI signal.</p> <p>RGB Full Utilizes the Full range RGB 0-255.</p> <p>RGB Limited Utilizes the Limited range RGB 16-235.</p> <p>YUV Full Utilizes the Full range YUV 0-255.</p> <p>YUV Limited Utilizes the Limited range YUV 16-235.</p>
	HDMI EDID	<p>Switch HDMI EDID between HDMI 1.4 or HDMI 2.0 in order to solve compatibility issue with uncertain old players.</p> <p>Enhance: Enhanced mode can switch to HDMI 2.0 EDID</p> <p>Standard: Standard mode can switch to HDMI 1.4 EDID.</p>
	HDMI Equalizer	Adjusts the equalizer gain settings for an HDMI signal. The higher the setting, the stronger the gain value. If there are more than one HDMI port on the projector, select the HDMI port first before adjusting the value.
	Presentation Timer	Reminds the presenter to finish the presentation within a certain time frame. See "Setting the presentation timer" on page 41 for details.
4. System Setup: Basic menu	Language	Sets the language for the On-Screen Display (OSD) menus. See "Using the menus" on page 30 for details.
	Projector Installation	The projector can be installed on a ceiling or behind a screen, or with one or more mirrors.
	Menu Settings	<p>Menu display time Sets the length of time the OSD will remain active after your last key press. The range is from 5 to 30 seconds in 5-second increments.</p> <p>Menu Position Sets the On-Screen Display (OSD) menu position.</p> <p>Reminder Message Enable or disable reminder message displays.</p>

FUNCTION	DESCRIPTION
4. System Setup: Basic menu Operation Settings	<p>Direct Power On Powers projector on automatically when the power cable is connected.</p> <p>Signal Power On Sets whether to turn the projector directly on without pressing POWER or ON when the projector is in standby mode and the signal is feed through the VGA cable.</p> <p>Auto Power Off Allows the projector to turn off automatically if no input signal is detected after a set period of time. See "Setting Auto Power Off" on page 68 for details.</p> <p>Quick Cooling Enables or disables the Quick Cooling function. Selecting On enables the function and the projector cooling time will be shortened from a normal 90 second duration to approximately 2 seconds.</p> <p> If you attempt to restart the projector right after the quick cooling process, it may not be turned on successfully and will rerun its cooling fans.</p> <p>Instant Restart Selecting On enables you to restart the projector immediately within 90 seconds after turning it off.</p> <p>Blank Timer Sets the image blank time when the Blank feature is activated, once elapsed the image will return to the screen. See "Hiding the image" on page 42 for details.</p> <p>Sleep Timer Sets the auto-shutdown timer. The timer can be set to a value between 30 minutes and 12 hours.</p>
	<p>Panel Key Lock Disables or enables all panel key functions except  POWER on the projector and keys on the remote control. See "Locking control keys" on page 43 for details.</p>
	<p>Background Color Selects background appearance when there is no signal.</p>
	<p>Splash Screen Allows you to select which logo screen will appear during projector start-up.</p>
	<p>USB Power Switch Disable or enables "Type A connector" 5V power output. Select Off when PointWrite Touch Module is not in use to prevent damage</p>

FUNCTION	DESCRIPTION
High Altitude Mode	A mode for operation in high altitude areas. See "Operating in a high altitude environment" on page 43 for details.
Audio Settings	See "Adjusting the sound" on page 44 for details.
Light Settings	<p>Light Mode See "Setting Light Mode as Economic or SmartEco" on page 68 for details.</p> <p>Reset Light Timer See "Resetting the light timer" on page 72 for details.</p> <p>Light Usage Time See "Getting to know the light hour" on page 67 for details on how the total lamp hour is calculated.</p>
Security Setting	<p>Change password You will be asked to enter the current password before changing to a new one. See "Utilizing the password function" on page 31 for details.</p> <p>Change Security Settings Input current password to activate Power On Lock function.</p> <p>Power On Lock When Power On Lock is activated, you will be asked to enter the current password before powering on the projector. If you enter incorrect password 5 times in succession, the projector will automatically shut down in a short time.</p>
Baud Rate	Selects a baud rate that is identical with your computer's so that you can connect the projector using a suitable RS-232 cable and update or download the projector's firmware. This function is intended for qualified service personnel.
Test Pattern	Selecting On enables the function and the projector displays the grid test pattern. It helps you adjust the image size and focus and check that the projected image is free from distortion.
Closed Caption	<p>Closed Caption Enable Activates the function by selecting On when the selected input signal carries closed captions.</p> <ul style="list-style-type: none"> • Captions: An on-screen display of the dialogue, narration, and sound effects of TV programs and videos that are closed captioned (usually marked as "CC" in TV listings). <p>Caption Version Selects a preferred closed captioning mode. To view captions, select CC1, CC2, CC3, or CC4 (CC1 displays captions in the primary language in your area).</p>

FUNCTION		DESCRIPTION
5. System Setup: Advanced menu	Standby Settings	<p>Network</p> <p>Enable Network Standby Mode</p> <p>To enable or disable the network standby mode after the projector is automatically or manually turned off.</p> <ul style="list-style-type: none"> • On: The projector will maintain at network standby mode with less than 2W power consumption. • Off: The projector will maintain at normal standby mode with less than 0.5W power consumption. <p>Switch To Normal Standby Mode</p> <p>To enable or disable the auto switch from network standby mode to non-network standby mode after a period of time. (This setting should be grayed out when Enable network standby mode is off.)</p> <ul style="list-style-type: none"> • Off: To disable the auto switch function. The projector will maintain at network standby mode with less than 2W power consumption. • 20 min / 1 hr / 3 hr / 6 hr: The projector will be switched to non-network standby mode after 20 minutes / 1 hour / 3 hours / 6 hours <p>Monitor Out</p> <p>Selecting On enables the function. The projector can output a VGA signal when it is in standby mode and the COMPUTER 1 jack is correctly connected to devices. See "Connection" on page 23 for how to make the connection.</p> <p>Audio Pass Through</p> <p>The projector can play sound when it is in standby mode and the corresponding jacks are correctly connected to devices. Press ◀/▶ to choose the source that you wish to use. See "Connection" on page 23 for how to make the connection.</p> <p> Enabling this function slightly increases the standby power consumption.</p>
	Network settings	<p>Wired LAN</p> <p>AMX Device Discovery</p> <p>When AMX Device Discovery is On, the projector can be detected by AMX controller.</p> <p>MAC Address</p> <p>Displays the mac address for this projector.</p>
	Reset All Settings	<p>Returns all settings to the factory preset values.</p> <p> The following settings will still remain: Position, Phase, H. Size, Projector Installation, Language, High Altitude Mode, Security Settings, Baud Rate.</p>

FUNCTION		DESCRIPTION
6. Information menu	Current System Status	Native Resolution Shows the native resolution.
		Source Shows the current signal source.
		Picture Mode Shows the selected mode in the Picture menu.
		Light Mode Shows the current light mode.
		Resolution Shows the native resolution of the input signal.
		3D Format Shows the current 3D mode.
		Color System Shows input system format, NTSC, PAL, SECAM, YUV or RGB.
		Light Usage Time Displays the number of hours the light has been used.
		Firmware Version Displays the firmware version of the projector.

 The Information menu shows you the current operating status of the projector.

Maintenance

Care of the projector

Your projector needs little maintenance. The only thing you need to do on a regular basis is to keep the lens clean.

Never remove any parts of the projector except the lamp. Contact your dealer if other parts need replacing.

Cleaning the Projector Mirror

Remove the dust with a "Bellows/Lens Blower" readily available from camera shops to prevent scratching the mirror with subsequently wiped.

Cleaning the lens

Clean the lens whenever you notice dirt or dust on the surface.

- Use a canister of compressed air to remove dust.
- If there is dirt or smears, use lens-cleaning paper or moisten a soft cloth with lens cleaner and gently wipe the lens surface.

 **Never use any type of abrasive pad, alkaline/acid cleaner, scouring powder, or volatile solvent, such as alcohol, benzene, thinner or insecticide. Using such materials or maintaining prolonged contact with rubber or vinyl materials may result in damage to the projector surface and cabinet material.**

Cleaning the projector case

Before you clean the case, turn the projector off using the proper shutdown procedure as described in "[Shutting down the projector](#)" on page 52 and unplug the power cord.

- To remove dirt or dust, wipe the case with a soft, lint-free cloth.
- To remove stubborn dirt or stains, moisten a soft cloth with water and a neutral pH detergent. Then wipe the case.

 **Never use wax, alcohol, benzene, thinner or other chemical detergents. These can damage the case.**

Storing the projector

If you need to store the projector for an extended time, please follow the instructions below:

- Make sure the temperature and humidity of the storage area are within the recommended range for the projector. Please refer to "[Specifications](#)" on page 75 or consult your dealer about the range.
- Retract the adjuster feet.
- Remove the battery from the remote control.
- Pack the projector in its original packing or equivalent.

Transporting the projector

It is recommended that you ship the projector with its original packing or equivalent. When you carry the projector yourself, please use the original box or a suitable soft carry case.

Light information

Getting to know the light hour

When the projector is in operation, the duration (in hours) of light usage is automatically calculated by the built-in timer. The method of calculating the equivalent light hour is as follows:

1. Light Usage Time = $(x+y+z+a)$ hours, if
Time used in Normal mode = x hours
Time used in Eco mode = y hours
Time used in SmartEco mode = z hours
Time used in LampSave mode = a hours
2. Equivalent Light Source Hour = α hours
 $\alpha = x(A' / X) + y(A' / Y) + z(A' / Z) + a(A' / A)$, if
 X = light life spec of Normal mode
 Y = light life spec of Eco mode
 Z = light life spec of SmartEco mode
 A = light life spec of LampSave mode
 A' is the longest light life spec among X, Y, Z, A

 For time used in each light mode shown in OSD menu:

- Time used is accumulated and rounded down to an integer in Hours.
- When time used is less than 1 hour, it shows 0 hours.



When you calculate Equivalent Light Source Hour manually, it will probably have deviation from the value shown in OSD menu since projector system calculates Time used for each Light Mode in Minutes then rounds down to an integer in hours shown in OSD.



See "[Setting Light Mode as Economic or SmartEco](#)" below for more information on Economic mode.

To obtain the light hour information:

1. Press **MENU/EXIT** and then press **◀/▶** until the **SYSTEM SETUP: Advanced** menu is highlighted.
2. Press **▼** to highlight **Light Settings** and press **MODE/ENTER**. The **Light Settings** page displays.
3. You will see the **Light Timer** information displaying on the menu.
4. To leave the menu, press **MENU/EXIT**.

You can also get the light hour information on the **INFORMATION** menu.

Extending light life

The projection light is a consumable item. To keep the light life as long as possible, you can do the following settings via the OSD menu.

Setting Light Mode as Economic or SmartEco

Using **Economic** mode reduces system noise and power consumption by 15%. Using **SmartEco** mode reduces system noise and light power consumption by up to 30%. If the **Economic** or **SmartEco** mode is selected, the light output will be reduced and result in darker projected pictures.

Setting the projector in **Economic** or **SmartEco** mode also extends the light operation life. To set **Economic** or **SmartEco** mode, go into the **SYSTEM SETUP: Advanced > Light Settings > Light Mode** menu and press **◀/▶** until your desired mode is selected.

Light mode	Description
Normal	100% lamp brightness
Economic	Saves 15% lamp power consumption
SmartEco	Saves up to 30% lamp power consumption depending on the content brightness level.
LampSave	Adjusts the lamp power automatically from 80% to 30% depending on the setting brightness.

 There is a time delay between light mode instances.

Setting Auto Power Off

This function allows the projector to turn off automatically if no input source is detected after a set period of time to prevent unnecessary waste of light life.

To set **Auto Power Off**, go into the **SYSTEM SETUP: Basic > Auto Power Off** menu and press **◀/▶**. The time period can be set from 5 to 30 minutes in 5-minute increments. If the preset time lengths are not suitable for your presentation, select **Disable**. The projector will not automatically shut down in a certain time period.

Timing of replacing the lamp

When the **Lamp indicator** lights up red or a message appears suggesting it is time to replace the lamp, please install a new lamp or consult your dealer. An old lamp may cause a malfunction in the projector and in some instances the lamp may explode.

Go to <http://www.benq.com> for a replacement lamp.

 **The Lamp indicator light and Temperature warning light will light up if the lamp becomes too hot. Turn the projector off and let the projector cool for 45 minutes. If the lamp or Temp indicator still lights up after turning the power back on, please contact your dealer. See "Indicators" on page 73 for details.**

The following lamp warning displays will remind you to change the lamp.

 **The warning messages below are for reference only. Please follow the actual on-screen instructions to prepare and replace the lamp.**

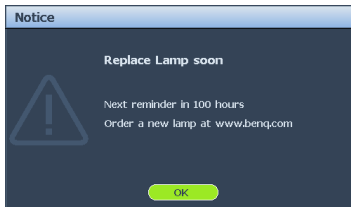
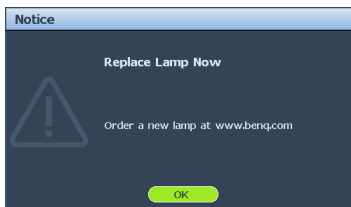
Status	Message
<p>Install a new lamp for optimal performance. If the projector is normally run with Economic selected (See "Setting Light Mode as Economic or SmartEco" on page 68), you may continue to operate the projector until the next lamp warning appears.</p> <p>It is strongly recommended that you replace the lamp at this age. The lamp is a consumable item. The lamp brightness diminishes with use. This is normal lamp behavior. You can replace the lamp whenever you notice that the brightness level has significantly diminished.</p> <p>Press MODE/ENTER to dismiss the message.</p>	 <p>The screenshot shows a dark blue message box with a light blue header labeled 'Notice'. On the left is a white warning triangle icon. The text reads: 'Replace Lamp soon', 'Next reminder in 100 hours', and 'Order a new lamp at www.benq.com'. At the bottom is a green 'OK' button.</p>
<p>The lamp MUST be replaced before the projector will operate normally.</p> <p>Press MODE/ENTER to dismiss the message.</p>	 <p>The screenshot shows a dark blue message box with a light blue header labeled 'Notice'. On the left is a white warning triangle icon. The text reads: 'Replace Lamp Now' and 'Order a new lamp at www.benq.com'. At the bottom is a green 'OK' button.</p>

Replacing the lamp



- If lamp replacement is performed while the projector is suspended upside-down from the ceiling, make sure that no one is underneath the lamp socket to avoid any possible injury or damage to the human eyes caused by fractured lamp.
 - To reduce the risk of electrical shock, always turn the projector off and disconnect the power cord before changing the lamp.
 - To reduce the risk of severe burns, allow the projector to cool for at least 45 minutes before replacing the lamp.
 - To reduce the risk of injuries to fingers and damage to internal components, use caution when removing lamp glass that has shattered into sharp pieces.
 - To reduce the risk of injuries to fingers and/or compromising image quality by touching the lens, do not touch the empty lamp compartment when the lamp is removed.
 - This lamp contains mercury. Consult your local hazardous waste regulations to dispose of this lamp in a proper manner.
 - To assure optimal performance from the projector, it is recommended that you purchase a BenQ projector lamp for lamp replacement.
 - Ensure good ventilation when handling broken lamps. We recommend that you use respirators, safety glasses, goggles or face shield and wear protective clothing such as gloves.
1. Turn the power off and disconnect the projector from the wall socket. If the lamp is hot, avoid burns by waiting for approximately 45 minutes until the lamp has cooled.
 2. Loosen the screw from the right side.
 3. Remove the lamp compartment cover as shown.

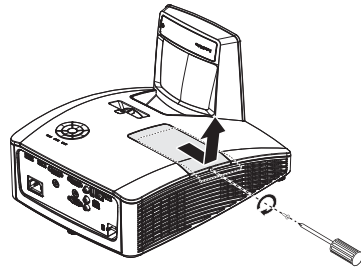

4. Loosen the two captive screws that secure the lamp.



- Do not turn the power on with the lamp cover removed.
- Do not insert your fingers between the lamp and the projector. The sharp edges inside the projector may cause injuries.

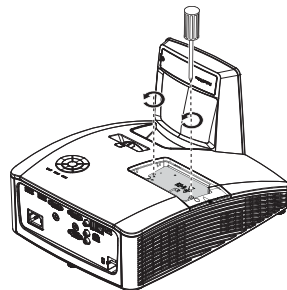

- Lift the handle so that it stands up. Use the handle to slowly pull the lamp out of the projector.



- Pulling it too quickly may cause the lamp to break and scatter broken glass in the projector.
- Do not place the lamp in locations where water might splash on it, children can reach it, or near flammable materials.
- Do not insert your hands into the projector after the lamp is removed. If you touch the optical components inside, it could cause color unevenness and distortion of the projected images.

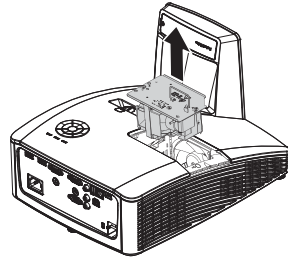

- Insert the new lamp into the lamp compartment and make sure it fits in the projector.



- Ensure the connectors are aligned.
- If you experience resistance, lift the lamp and start again.

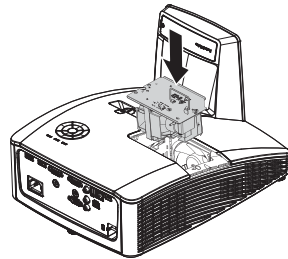

- Tighten the screws that secure the lamp.
- Ensure the handle is fully laid flat and locked in place.



- Loose screw may cause a bad connection, which could result in malfunction.
- Do not over tighten the screw.

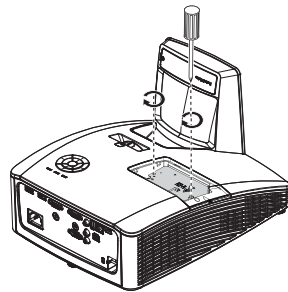

- Replace the lamp compartment cover on the projector and tighten the screw.

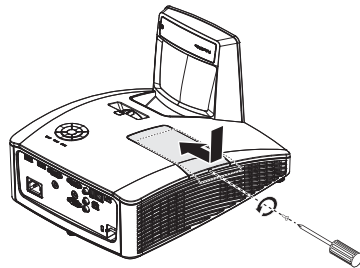

- Restart the projector.



- Do not turn the power on with the lamp cover removed.

Resetting the light timer

11. After the startup logo, open the On-Screen Display (OSD) menu. Go to the **SYSTEM SETUP: Advanced > Light Settings** menu. Press **MODE/ENTER**. The **Light Settings** page displays. Highlight **Reset light timer**. A warning message displays asking if you want to reset the light timer. Highlight **Reset** and press **MODE/ENTER**. The light time will be reset to '0'.

 Do not reset if the lamp is not new or replaced as this could cause damage.

Cleaning the projector mirror

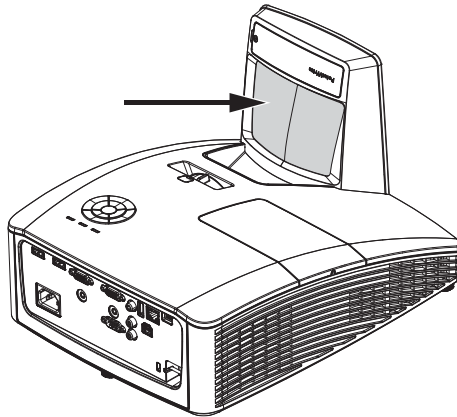

Remove dust with a "Bellows/Lens Blower" readily available from Camera shops to prevent scratching the mirror when subsequently wiped.

-  • Always turn the projector off and allow to cool for at least 30 minutes prior to cleaning.
- Never touch the projector mirror or Lens directly by hand.

Indicators

Light			Status & Description
Power	Temp	Lamp	
System Messages			
Orange	Off	Off	Stand-by mode
Green Flashing	Off	Off	Powering up
Green	Off	Off	Normal operation
Orange Flashing	Off	Off	Normal power-down cooling
Red Flashing	Red Flashing	Red Flashing	Download
Green	Off	Red	CW start fail
Red Flashing	Off	Off	Scaler shutdown fail (data aboard)
Off	Red	Off	LAN download fail
Off	Green	Off	LAN download processing
Green	Off	Orange	Light life exhausted
Off	Green	Red	Light door open
Burn-In Messages			
Green	Off	Off	Burn-in ON
Green	Green	Green	Burn-in OFF
Lamp Error Messages			
Off	Off	Red	Lamp1 error in normal operation
Off	Off	Orange Flashing	Lamp is not lit up
System events			
Red	Red	Off	Fan 1 error (the actual fan speed is outside the desired speed)
Red	Red Flashing	Off	Fan 2 error (the actual fan speed is outside the desired speed)
Red	Green	Off	Fan 3 error (the actual fan speed is outside the desired speed)
Red	Green Flashing	Off	Fan 4 error (the actual fan speed is outside the desired speed)
Green	Red	Off	Temperature 1 error (over limited temperature)
Green	Red Flashing	Off	Thermal Sensor 1 open error
Green	Green	Off	Thermal Sensor 1 short error
Green	Green Flashing	Off	Thermal IC #1 I2C Connection error
Green	Red	Red	Thermal Break error

Troubleshooting

⑦ The projector does not turn on.

Cause	Remedy
There is no power from the power cable.	Plug the power cord into the AC inlet on the projector, and plug the power cord into the power outlet. If the power outlet has a switch, make sure that it is switched on.
Attempting to turn the projector on again during the cooling process.	Wait until the cooling down process has completed.

⑦ No picture

Cause	Remedy
The video source is not turned on or connected correctly.	Turn the video source on and check that the signal cable is connected correctly.
The projector is not correctly connected to the input signal device.	Check the connection.
The input signal has not been correctly selected.	Select the correct input signal with the SOURCE key on the projector or remote control.

⑦ Blurred image

Cause	Remedy
The projection lens is not correctly focused.	Adjust the focus of the lens using the focus ring.
The projector and the screen are not aligned properly.	Adjust the projection angle and direction as well as the height of the unit if necessary.

⑦ Remote control does not work

Cause	Remedy
The battery is out of power.	Replace the battery with new one.
There is an obstacle between the remote control and the projector.	Remove the obstacle.
You are too far away from the projector.	Stand within 7 meters (23 feet) of the projector.

⑦ The password is incorrect

Cause	Remedy
You do not remember the password.	Please see " Entering the password recall procedure " on page 32 for details.

Specifications

Projector specifications

 All specifications are subject to change without notice.

Optical

Resolution

MW855UST+

1280 x 800 WXGA

MH856UST+

1920 x 1080 1080p

Display system

Single-chip DLP™ system

Lens F/Number

F = 2.5, f = 5.1 mm

Lamp

240W lamp

Electrical

Power supply

AC100-240V, 3.8A

50-60 Hz (Automatic)

Power consumption

350W (Max); < 0.5W (Standby)

Mechanical

Weight

11 lbs (5 Kg)

Output terminals

Speaker

10 watt x 2

Audio signal output

PC audio jack x 1

Monitor Out

D-Sub 15-pin (female) x1

Control

USB

Type-B mini USB

(Optional for PointWrite kit)

Type-A power supply 1.5A

RS-232 serial control

9-pin x 1

IR receiver x 1

LAN control

RJ45 x 1

Input terminals

Computer input

RGB input

D-Sub 15-pin (female) x 1

Video signal input

VIDEO

RCA jack x 1

SD/HDTV signal input

Analog - Component (through RGB input)

Digital - HDMI x 2

Audio signal input

Audio in

PC audio jack x 1

RCA audio jack (L/R) x 1

Environmental Requirements

Temperature

Operating: 0°C–40°C at sea level

Storage: -20°C–60°C at sea level

Relative humidity

Operating: 10%–90% (without condensation)

Storage: 10%–90% (without condensation)

Transporting

Original packing or equivalent is recommended.

Repairing

Please visit below website and choose your country to find your service contact window.

<http://www.benq.com/welcome>

Timing chart

Supported timing for PC input

Resolution	Mode	Refresh Rate (Hz)	H-frequency (kHz)	Clock (MHz)	3D Field Sequential	3D Over-under	3D Side-by-side
640 x 480	VGA_60	59.940	31.469	25.175			
	VGA_72	72.809	37.861	31.500			
	VGA_75	75.000	37.500	31.500			
	VGA_85	85.008	43.269	36.000			
720 x 400	720 x 400_70	70.087	31.469	28.3221			
800 x 600	SVGA_60	60.317	37.879	40.000			
	SVGA_72	72.188	48.077	50.000			
	SVGA_75	75.000	46.875	49.500			
	SVGA_85	85.061	53.674	56.250			
	SVGA_120 (Reduce Blanking)	119.854	77.425	83.000			
1024 x 768	XGA_60	60.004	48.363	65.000			
	XGA_70	70.069	56.476	75.000			
	XGA_75	75.029	60.023	78.750			
	XGA_85	84.997	68.667	94.500			
	XGA_120 (Reduce Blanking)	119.989	97.551	115.500			
1152 x 864	1152 x 864_75	75.00	67.500	108.000			
1280 x 720	1280 x 720_60	60	45.000	74.250			
1280 x 768	1280 x 768_60	59.870	47.776	79.5			
1280 x 800	WXGA_60	59.810	49.702	83.500			
	WXGA_75	74.934	62.795	106.500			
	WXGA_85	84.880	71.554	122.500			
	WXGA_120 (Reduce Blanking)	119.909	101.563	146.25			
1280 x 1024	SXGA_60	60.020	63.981	108.000			
	SXGA_75	75.025	79.976	135.000			
	SXGA_85	85.024	91.146	157.500			
1280 x 960	1280 x 960_60	60.000	60.000	108			
	1280 x 960_85	85.002	85.938	148.500			

Resolution	Mode	Refresh Rate (Hz)	H-frequency (kHz)	Clock (MHz)	3D Field Sequential	3D Over-under	3D Side-by-side
1360 x 768	1360 x 768_60	60.015	47.712	85.500			
1440 x 900	WXGA+_60	59.887	55.935	106.500			
1400 x 1050	SXGA+_60	59.978	65.317	121.750			
1600 x 1200	UXGA	60.000	75.000	162.000			
1680 x 1050	1680 x 1050_60	59.954	65.290	146.250			
640 x 480 @67Hz	MAC13	66.667	35.000	30.240			
832 x 624 @75Hz	MAC16	74.546	49.722	57.280			
1024 x 768 @75Hz	MAC19	74.93	60.241	80.000			
1152 x 870 @75Hz	MAC21	75.06	68.68	100.00			
1920 x 1080 @60HZ	1920 x 1080_60	60	67.5	148.5			
1920 x 1200	1920x1200_60 (Reduce Blanking)	59.950	74.038	154.000			

 There 3D timing showing depend the EDID file and VGA display card. It is possible that user cannot choose the above 3D timings on VGA display card.

Support timing for Component - YPbPr input

Timing	Resolution	Horizontal Frequency (KHz)	Vertical Frequency (Hz)	Dot Clock Frequency (MHz)	3D Field Sequential
480i	720 x 480	15.73	59.94	13.50	
480p	720 x 480	31.47	59.94	27.00	
576i	720 x 576	15.63	50	13.50	
576p	720 x 576	31.25	50	27.00	
720/50p	1280 x 720	37.50	50	74.25	
720/60p	1280 x 720	45.00	60	74.25	
1080/50i	1920 x 1080	28.13	50	74.25	
1080/60i	1920 x 1080	33.75	60	74.25	
1080/24p	1920 x 1080	27.00	24	74.25	
1080/25p	1920 x 1080	28.13	25	74.25	
1080/30p	1920 x 1080	33.75	30	74.25	
1080/50p	1920 x 1080	56.25	50	148.50	
1080/60p	1920 x 1080	67.50	60	148.50	

Support timing for Video input

Video Mode	Horizontal Frequency (KHz)	Vertical Frequency (Hz)	Sub-carrier Frequency (MHz)	3D Field Sequential
NTSC	15.73	60	3.58	
PAL	15.63	50	4.43	
SECAM	15.63	50	4.25 or 4.41	
PAL-M	15.73	60	3.58	
PAL-N	15.63	50	3.58	
PAL-60	15.73	60	4.43	
NTSC4.43	15.73	60	4.43	

Support timing for HDMI (HDCP) input

Resolution	Mode	Refresh Rate (Hz)	H-frequency (kHz)	Clock (MHz)	3D Field Sequential	3D Over-under	3D Side-by-side
640 x 480	VGA_60	59.940	31.469	25.175			
	VGA_72	72.809	37.861	31.500			
	VGA_75	75.000	37.500	31.500			
	VGA_85	85.008	43.269	36.000			
720 x 400	720 x 400_70	70.087	31.469	28.3221			
800 x 600	SVGA_60	60.317	37.879	40.000			
	SVGA_72	72.188	48.077	50.000			
	SVGA_75	75.000	46.875	49.500			
	SVGA_85	85.061	53.674	56.250			
	SVGA_120 (Reduce Blanking)	119.854	77.425	83.000			
1024 x 768	XGA_60	60.004	48.363	65.000			
	XGA_70	70.069	56.476	75.000			
	XGA_75	75.029	60.023	78.750			
	XGA_85	84.997	68.667	94.500			
	XGA_120 (Reduce Blanking)	119.989	97.551	115.500			
1152 x 864	1152 x 864_75	75.00	67.500	108.000			
1280 x 720	1280 x 720_60	60	45.000	74.250			
1280 x 768	1280 x 768_60	59.870	47.776	79.5			
1280 x 800	WXGA_60	59.810	49.702	83.500			
	WXGA_75	74.934	62.795	106.500			
	WXGA_85	84.880	71.554	122.500			
	WXGA_120 (Reduce Blanking)	119.909	101.563	146.25			
1280 x 1024	SXGA_60	60.020	63.981	108.000			
	SXGA_75	75.025	79.976	135.000			
	SXGA_85	85.024	91.146	157.500			
1280 x 960	1280 x 960_60	60.000	60.000	108			
	1280 x 960_85	85.002	85.938	148.500			
1360 x 768	1360 x 768_60	60.015	47.712	85.500			
1440 x 900	WXGA+_60	59.887	55.935	106.500			

Resolution	Mode	Refresh Rate (Hz)	H-frequency (kHz)	Clock (MHz)	3D Field Sequential	3D Over-under	3D Side-by-side
1400 x 1050	SXGA+_60	59.978	65.317	121.750			
1600 x 1200	UXGA	60.000	75.000	162.000			
1680 x 1050	1680 x 1050_60	59.954	65.290	146.250			
1920 x 1080 @60Hz	1920 x 1080_60	60	67.5	148.5			
1920 x 1200	1920 x 1200_60 (Reduce Blanking)	59.950	74.038	154.000			
640 x 480 @67Hz	MAC13	66.667	35.000	30.240			
832 x 624 @75Hz	MAC16	74.546	49.722	57.280			
1024 x 768 @75Hz	MAC19	75.020	60.241	80.000			
1152 x 870 @75Hz	MAC21	75.06	68.68	100.00			
3840 x 2160	3840 x 2160_30 For 4K2K model	30	67.5	297			
3840 x 2160	3840 x 2160_60	60	135	594			

Support Audio:

1. HDMI Mode:

- Support LPCM, two audio channels
- Support audio sampling rate : 32kHz, 44.1kHz, 48kHz
- Support audio bit rate : 16 bits, 20 bits, 24 bits

2. DVI Mode:

Analog audio is supported through PC audio input terminal.

 There timing showing depend the EDID file and VGA graphic card limitation. It is possible that user cannot choose the above timings on VGA display card.

Supporting timing for HDMI Video input

Timing	Resolution	Horizontal Frequency (KHz)	Vertical Frequency (Hz)	Dot Clock Frequency (MHz)	3D Field Sequential	3D Frame Packing	3D Over-under	3D Side-by-side
480i	720 (1440) x 480	15.73	59.94	27				
480p	720 x 480	31.47	59.94	27				
576i	720 (1440) x 576	15.63	50	27				
576p	720 x 576	31.25	50	27				
720/50p	1280 x 720	37.50	50	74.25				
720/60p	1280 x 720	45.00	60	74.25				
1080/24p	1920 x 1080	27.00	24	74.25				
1080/25p	1920 x 1080	28.13	25	74.25				
1080/30p	1920 x 1080	33.75	30	74.25				
1080/50i	1920 x 1080	28.13	50	74.25				
1080/60i	1920 x 1080	33.75	60	74.25				
1080/50p	1920 x 1080	56.25	50	148.5				
1080/60p	1920 x 1080	67.50	60	148.5				
2160/24p	3840 x 2160	54.00	24	297				
2160/25p	3840 x 2160	56.25	25	297				
2160/30p	3840 x 2160	67.50	30	297				
2160/50p	3840 x 2160	112.50	50	594				
2160/60p	3840 x 2160	135.00	60	594				

Warranty and Copyright information

Limited warranty

BenQ warrants this product against any defects in material and workmanship, under normal usage and storage.

Proof of purchase date will be required with any warranty claim. In the event this product is found to be defective within the warranty period, BenQ's only obligation and your exclusive remedy shall be replacement of any defective parts (labor included). To obtain warranty service, immediately notify the dealer from which you purchased the product of any defects.

Important: The above warranty shall be void if the customer fails to operate the product in accordance with BenQ's written instructions, especially the ambient humidity must be in-between 10% and 90%, temperature in-between 0°C and 35°C, altitude lower than 4920 feet, and avoiding to operate the projector in a dusty environment. This warranty gives you specific legal rights, and you may have other rights which vary from country to country.

For other information, please visit www.BenQ.com.

Copyright

Copyright 2011 by BenQ Corporation. All rights reserved. No part of this publication may be reproduced, transmitted, transcribed, stored in a retrieval system or translated into any language or computer language, in any form or by any means, electronic, mechanical, magnetic, optical, chemical, manual or otherwise, without the prior written permission of BenQ Corporation.

Disclaimer

BenQ Corporation makes no representations or warranties, either expressed or implied, with respect to the contents hereof and specifically disclaims any warranties, merchantability or fitness for any particular purpose. Further, BenQ Corporation reserves the right to revise this publication and to make changes from time to time in the contents hereof without obligation to notify any person of such revision or changes.

*DLP, Digital Micromirror Device and DMD are trademarks of Texas Instruments. Others are copyrights of their respective companies or organizations.

Patents

Please go to <http://patmarking.benq.com/> for the details of the BenQ projector patent