

SAMSUNG

User Manual

SNOW-1703U
IF015H IF020H IF025H

The color and the appearance may differ depending on the product,
and the specifications are subject to change without prior notice to
improve the performance.

Table of contents

Before Using the Product

Copyright	5
Safety Precautions	6
Electricity and Safety	6
Installation	7
Operation	8
Cleaning	9
Storage	9

Preparations

Parts	10
Front Side (SNOW-1703U)	10
Reverse Side (SNOW-1703U)	11
Interface Gender Card (I/G Card)	12
Reverse Side (IF015H IF020H IF025H)	13
Remote Control	14
Remote Control (SNOW-1703U model only)	16
Cable Connection	16
Connection	19
Control Codes	20

Connecting and using devices

Before Connecting	23
Pre-connection Checkpoints	23
Connecting to a PC	23

Connection Using an HDMI Cable	23
Connection Using an HDMI-DVI Cable	24
Connection Using an DP Cable	24

Connecting to a Video Device	25
Connection Using an HDMI-DVI Cable	25
Connection Using an HDMI Cable	25

Connecting the LAN Cable	26
--------------------------	----

SNOW-1703U Installation Precautions	26
-------------------------------------	----

Installing the cabinets	27
Removing the protective brackets	27
Replacing the cabinet module	27

Precautions when handling the cabinets	28
--	----

Restrictions when installing cabinets	28
---------------------------------------	----

Connecting to cabinets	29
Recommended number of devices for connection for each input voltage	29

Changing the Input source	30
Source	30

Web Browser	31
Settings	31
Refresh Options	33

Using LED Signage Manager

Player feature

Player	35
Viewing content	35
When content is running	36
Available menu	36
File Formats Compatible with Player	37

Schedule	42
----------	----

Clone Product	43
---------------	----

ID Settings	44
Device ID	44
PC Connection Cable	44

Video Wall	45
Video Wall	45
Horizontal x Vertical	45
Screen Position	45
Format	46

Network Status	47
----------------	----

Picture Mode	48
--------------	----

On/Off Timer	49
On Timer	49
Off Timer	50
Holiday Management	50

Ticker	51
--------	----

URL Launcher	52
--------------	----

URL Launcher Settings	53
-----------------------	----

Table of contents

Approving a connected device from the server	54
Setting the current time	55

Picture

Picture Mode	56
--------------	----

Contrast / Brightness / Sharpness / Color / Tint (G/R)	57
--	----

Color Temperature	57
-------------------	----

White Balance	57
2 Point	57
10 Point	57

Gamma	58
-------	----

Advanced Settings	58
Dynamic Contrast	58
Black Tone	58
Flesh Tone	58
RGB Only Mode	58
Color Space	58
HDMI UHD Color	58

LED Picture Size	59
Resolution	59
Fit to screen	59

LED HDR	59
Inverse Tone Mapping	59
Dynamic Peaking	59
Color Mapping	59

Picture Options	60
Color Tone	60
Digital Clean View	60
HDMI Black Level	60
Film Mode	60

Reset Picture	60
---------------	----

OnScreen Display

Screen Protection	61
Auto Protection Time	61

Message Display	62
Source Info	62
No Signal Message	62
MDC Message	62
Download Status Message	62

Language	62
----------	----

Menu Size	62
-----------	----

Reset OnScreen Display	62
------------------------	----

Network

Network Status	63
----------------	----

Open Network Settings	63
Network Settings	64

Server Network Settings	66
-------------------------	----

Connect to Server	66
MagicInfo Mode	66
Server Access	66
FTP Mode	66
Proxy Server	66

Device Name	66
-------------	----

System

Accessibility	67
Menu Transparency	67
High Contrast	67
Enlarge	67

Start Setup	68
-------------	----

Time	68
Clock Set	68
DST	68
Sleep Timer	68
Power On Delay	68

Auto Source Switching	69
Auto Source Switching	69
Primary Source Recovery	69
Primary Source	69
Secondary Source	69

Power Control	70
Auto Power On	70
Max. Power Saving	70
Standby Control	70

Table of contents

Network Standby	70
Power Button	70
<hr/>	
Eco Solution	70
No Signal Power Off	70
Auto Power Off	70
<hr/>	
Temperature Control	71
<hr/>	
Input Device Manager	71
Keyboard Language	71
Keyboard Type	71
Input Language Shortcut	71
<hr/>	
Play via	71
<hr/>	
Change PIN	71
<hr/>	
Security	72
Safety Lock On	72
Button Lock	72
USB Auto Play Lock	72
Remote Management	72
<hr/>	
General	73
Smart Security	73
Anynet+ (HDMI-CEC)	73
Custom Logo	75
Game Mode	75
<hr/>	
Reset System	75

Support

Software Update	76
Update Now	76
Auto Update	76
<hr/>	
Contact Samsung	76
<hr/>	
Reset All	76

Playing photos and videos (Media Play)

Read the following before using media play with a USB device	77
Using a USB device	79
<hr/>	
Features provided in the media content list page	80
Menu items in the media content list page	81
<hr/>	
Available buttons and features during photo playback	82
<hr/>	
Available buttons and features during video playback	82

Troubleshooting Guide

Requirements Before Contacting Samsung Customer Service Center	83
Testing the Product	83
Checking the Resolution and Frequency	83
Check the followings.	84
<hr/>	
Q & A	89

Specifications

General	91
<hr/>	
Preset Timing Modes	93

Appendix

Responsibility for the Pay Service (Cost to Customers)	95
Not a product defect	95
A Product damage caused by customer's fault	95
Others	95
<hr/>	
License	96

Chapter 01

Before Using the Product

Copyright

The contents of this manual are subject to change without notice to improve quality.

© 2017 Samsung Electronics

Samsung Electronics owns the copyright for this manual.

Use or reproduction of this manual in parts or entirety without the authorization of Samsung Electronics is prohibited.

Microsoft, Windows are registered trademarks of Microsoft Corporation.

VESA, DPM and DDC are registered trademarks of the Video Electronics Standards Association.

Ownership of all other trademarks is attributed to their due owner.

- An administration fee may be charged if either
 - (a) an engineer is called out at your request and there is no defect in the product (i.e. where you have failed to read this user manual).
 - (b) you bring the unit to a repair center and there is no defect in the product (i.e. where you have failed to read this user manual).
- The amount of such administration charge will be advised to you before any work or home visit is carried out.

Safety Precautions

Caution

RISK OF ELECTRIC SHOCK DO NOT OPEN

Caution : TO REDUCE THE RISK OF ELECTRIC SHOCK, DO NOT REMOVE COVER. (OR BACK)

THERE ARE NO USER SERVICEABLE PARTS INSIDE.

REFER ALL SERVICING TO QUALIFIED PERSONNEL.



This symbol indicates that high voltage is present inside.

It is dangerous to make any kind of contact with any internal part of this product.



This symbol alerts you that important literature concerning operation and maintenance has been included with this product.

Electricity and Safety

Warning

Do not use a damaged power cord or plug, or a loose power socket.

- An electric shock or fire may result.

Do not use multiple products with a single power socket.

- Overheated power sockets may cause a fire.

Do not touch the power plug with wet hands. Otherwise, an electric shock may result.

Insert the power plug all the way in so it is not loose.

- An unsecure connection may cause a fire.

Connect the power plug to a grounded power socket (type 1 insulated devices only).

- An electric shock or injury may result.

Do not bend or pull the power cord with force. Be careful not to leave the power cord under a heavy object.

- Damage to the cord may result in a fire or electric shock.

Do not place the power cord or product near heat sources.

- A fire or electric shock may result.

Clean any dust around the pins of the power plug or the power socket with a dry cloth.

- A fire may result.

Caution

Do not disconnect the power cord while the product is being used.

- The product may become damaged by an electric shock.

Only use the power cord provided with your product by Samsung. Do not use the power cord with other products.

- A fire or electric shock may result.

Keep the power socket where the power cord is connected unobstructed.

- The power cord must be disconnected to cut off power to the product when an issue occurs.
- Note that the product is not completely powered down by using only the power button on the remote.

Hold the plug when disconnecting the power cord from the power socket.

- An electric shock or fire may result.

Installation

Warning

DO NOT PLACE CANDLES, INSECT REPELLANTS OR CIGARETTES ON TOP OF THE PRODUCT. DO NOT INSTALL THE PRODUCT NEAR HEAT SOURCES.

- A fire may result.

Have a technician install the wall-mount hanger.

- Installation by an unqualified person can result in an injury.
- Only use approved cabinets.

Do not install the product in poorly ventilated spaces such as a bookcase or closet.

- An increased internal temperature may cause a fire.

Install the product at least 10 cm away from the wall to allow ventilation.

- An increased internal temperature may cause a fire.

Keep the plastic packaging out of the reach of children.

- Children may suffocate.

Do not install the product on an unstable or vibrating surface (insecure shelf, sloped surface, etc.)

- The product may fall and become damaged and/or cause an injury.
- Using the product in an area with excess vibration may damage the product or cause a fire.

Do not install the product in a vehicle or a place exposed to dust, moisture (water drips, etc.), oil, or smoke.

- A fire or electric shock may result.

Do not expose the product to direct sunlight, heat, or a hot object such as a stove.

- The product lifespan may be reduced or a fire may result.

Do not install the product within the reach of young children.

- The product may fall and injure children.

Edible oil, such as soybean oil, can damage or deform the product. Do not install the product in a kitchen or near a kitchen counter.

Caution

Do not drop the product while moving.

- Product failure or personal injury may result.

Do not set down the product on its front.

- The screen may become damaged.

When installing the product on a cabinet or shelf, make sure that the bottom edge of the front of the product is not protruding.

- The product may fall and become damaged and/or cause an injury.
- Install the product only on cabinets or shelves of the right size.

Set down the product gently.

- Product failure or personal injury may result.

Installing the product in an unusual place (a place exposed to a lot of fine dust, chemical substances, extreme temperatures or a significant presence of moisture, or a place where the product will operate continuously for an extended period of time) may seriously affect its performance.

- Be sure to consult Samsung Customer Service Center if you want to install the product at such a place.

Operation

Warning

There is a high voltage inside the product. Never disassemble, repair or modify the product yourself.

- A fire or electric shock may result.
- Contact Samsung Customer Service Center for repairs.

Before moving the product, turn off the power switch and disconnect the power cable and all other connected cables.

- Damage to the cord may result in a fire or electric shock.

If the product generates abnormal sounds, a burning smell or smoke, disconnect the power cord immediately and contact Samsung Customer Service Center.

- An electric shock or fire may result.

If the product is dropped or the outer case is damaged, turn off the power switch and disconnect the power cord. Then contact Samsung Customer Service Center.

- Continued use can result in a fire or electric shock.

Do not leave heavy objects or items that children like (toys, sweets, etc.) on top of the product.

During a lightning or thunderstorm, power off the product and remove the power cable.

- A fire or electric shock may result.

Do not drop objects on the product or apply impact.

- A fire or electric shock may result.

Do not move the product by pulling the power cord or any cable.

- Product failure, an electric shock or fire may result from a damaged cable.

If a gas leakage is found, do not touch the product or power plug. Also, ventilate the area immediately.

- Sparks can cause an explosion or fire.

Do not lift or move the product by pulling the power cord or any cable.

- Product failure, an electric shock or fire may result from a damaged cable.

Do not use or keep combustible spray or an inflammable substance near the product.

- An explosion or fire may result.

Ensure the vents are not blocked by tablecloths or curtains.

- An increased internal temperature may cause a fire.

Do not insert metallic objects (chopsticks, coins, hairpins, etc) or objects that burn easily (paper, matches, etc) into the product (via the vent or input/output ports, etc).

- Be sure to power off the product and disconnect the power cord when water or other foreign substances have entered the product. Then contact Samsung Customer Service Center.
- Product failure, an electric shock or fire may result.

Do not place objects containing liquid (vases, pots, bottles, etc) or metallic objects on top of the product.

- Be sure to power off the product and disconnect the power cord when water or other foreign substances have entered the product. Then contact Samsung Customer Service Center.
- Product failure, an electric shock or fire may result.

Caution

Disconnect the power cord from the power socket if you do not plan on using the product for an extended period of time (vacation, etc).

- Dust accumulation combined with heat can cause a fire, electric shock or electric leakage.

Do not put DC power adapters together.

- Otherwise, a fire may result.

Remove the plastic bag from the DC power adapter before you use it.

- Otherwise, a fire may result.

Do not let water enter the DC power device or get the device wet.

- An electric shock or fire may result.
- Avoid using the product outdoors where it can be exposed to rain or snow.
- Be careful not to get the DC power adapter wet when you wash the floor.

Do not put the DC power adapter near to any heating apparatus.

- Otherwise, a fire may result.

Keep the DC power adapter in a well-ventilated area.

If you place the AC/DC power adapter so that it is hanging with the cord input facing upwards, water or other foreign substances could enter the Adapter and cause the Adapter to malfunction.

Make sure to rest the AC/DC power adapter flat on a table or the floor.

The screen is bright. Keep a sufficient distance from the screen.

- Continuously looking at the screen up close is bad for your eyes.
 - e.g., pixels x 3 m
 - For IF015H: 1.5 x 3 m = a distance of at least 4.5 m is recommended
 - For IF020H: 2.0 x 3 m = a distance of at least 6.0 m is recommended
 - For IF025H: 2.5 x 3 m = a distance of at least 7.5 m is recommended

Do not use humidifiers or stoves around the product.

- A fire or electric shock may result.

Do not touch the product if it has been turned on for a long time. The product may be hot.

Store small accessories out of the reach of children.

Do not place heavy objects on the product.

- Product failure or personal injury may result.

Be careful that children do not place the battery in their mouths when removed from the remote control. Place the battery in a location that children or infants cannot reach.

- If children have had the battery in their mouths, consult your doctor immediately.

When replacing the battery, insert it with the right polarity (+, -).

- Otherwise, the battery may become damaged or it may cause fire, personal injury or damage due to leakage of the internal liquid.

Use only the specified standardized batteries, and do not use a new battery and a used battery at the same time.

- Otherwise, the batteries may be damaged or cause fire, personal injury or damage due to a leakage of the internal liquid.

The batteries (and rechargeable batteries) are not ordinary refuse and must be returned for recycling purposes. The customer is responsible for returning the used or rechargeable batteries for recycling.

- The customer can return used or rechargeable batteries to a nearby public recycling center or to a store selling the same type of the battery or rechargeable battery.

Do not dispose of batteries in a fire.

Cleaning

- Be careful when touching the LED fixture on the front of the product. There is a risk that LED elements may fall off.

Storage

- Contact Customer Service Center if the inside of the product needs cleaning (service fee will be charged).

Chapter 02

Preparations

Parts

Front Side (SNOW-1703U)

— The color and shape of parts may differ from what is shown. Specifications are subject to change without notice to improve quality.





Parts	Description
HDBT 4, HDBT 3, HDBT 2, HDBT 1	View the input HDBT source status of SNOW-1703U. 4 : HDBT 4 / 3 : HDBT 3 / 2 : HDBT 2 / 1 : HDBT 1
LAN	View the input LAN source status of SNOW-1703U.
SOURCE STATUS	View the input source status of SNOW-1703U. RED : HDMI 1 / GREEN : HDMI 2 / BLUE : DISPLAY PORT
POWER STATUS	View the power status of SNOW-1703U. RED : OFF / GREEN : ON / BLINKING : STANDBY

Parts	Description
	Turn the product on or off.
IR	Aim the remote control towards this spot on the LCD Display. — Using other display devices in the same space as the remote control of this product can cause the other display devices to be inadvertently controlled.

Reverse Side (SNOW-1703U)

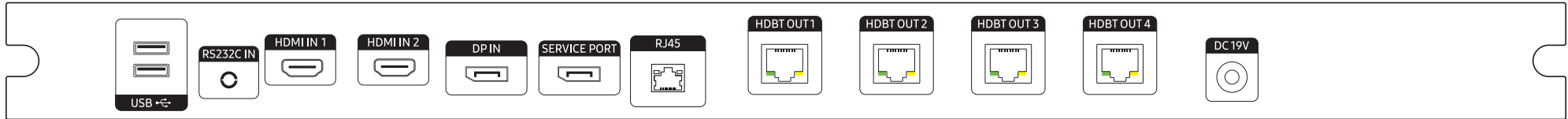
— The color and shape of parts may differ from what is shown. Specifications are subject to change without notice to improve quality.



Parts	Description
USB 	Connect to a USB memory device.
RS232C IN	Used for service purposes.
HDMI IN 1, HDMI IN 2	Connects to a source device using a HDMI cable or HDMI-DVI cable.
DP IN	Connects to a PC using a DP cable.
SERVICE PORT	Dedicated to service technicians. — This port is for servicing only and has no user function. Do not connect a cable to this port.

Parts	Description
RJ45	Connect to a network using the LAN cable.
HDBT OUT 1, HDBT OUT 2, HDBT OUT 3, HDBT OUT 4	Connects to an interface gender. Each port can transmit Full HD signals. All the four ports must be used to transmit UHD signals.
DC 19V	Connects to the DC power adapter.

Interface Gender Card (I/G Card)

— The color and shape of parts may differ from what is shown. Specifications are subject to change without notice to improve quality.

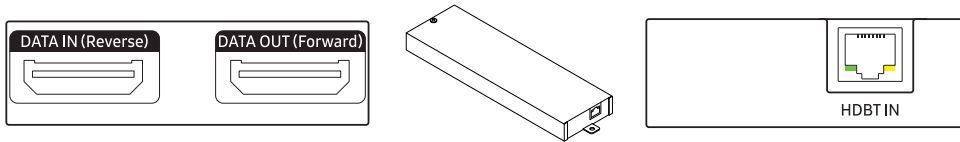

Parts	Description
DATA IN (Reverse)	Connects to the DATA OUT port on the last cabinet using an OCM cable.
DATA OUT (Forward)	Connects to the DATA IN port on the first cabinet using an OCM cable.
HDBT IN	Connects to the HDBT OUT port on SNOW-1703U using an HDBT cable.

Reverse Side (IF015H IF020H IF025H)

— The color and shape of parts may differ from what is shown. Specifications are subject to change without notice to improve quality.

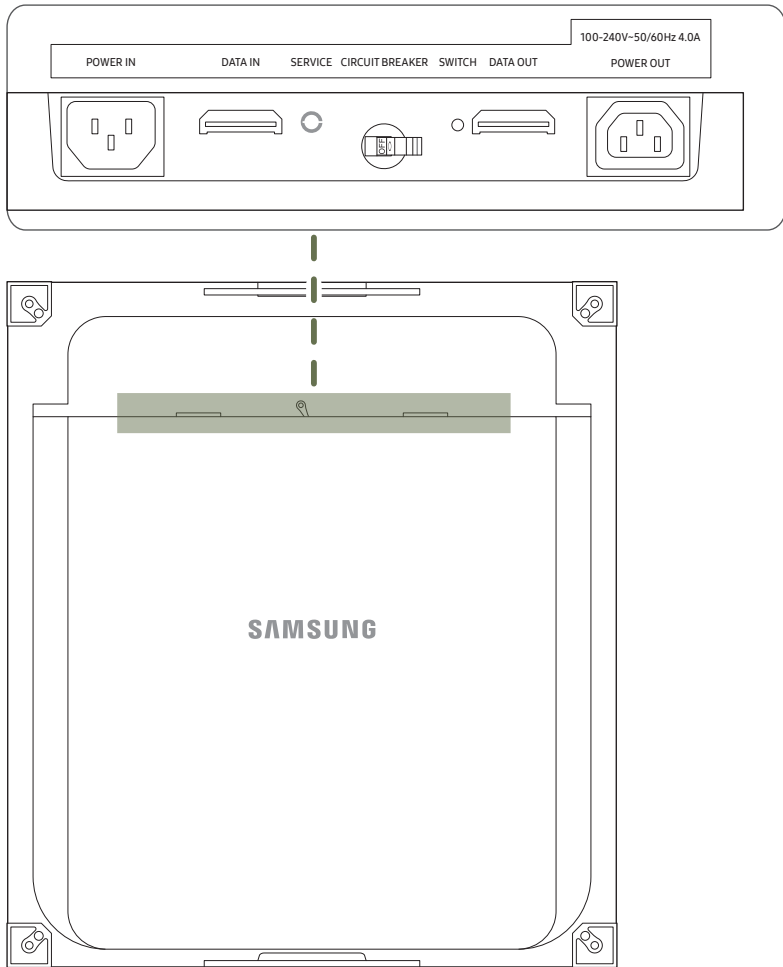

Parts	Description
POWER IN	Connects to an AC power.
DATA IN	Connects to the DATA OUT port on an interface gender or on the previous cabinet to receive video data.
SERVICE	Dedicated to service technicians.
CIRCUIT BREAKER	Disconnects the cabinet AC output in case of power leakage or short-circuit.
SWITCH	Enters factory mode (press and hold for 5 seconds) or factory reset mode (press and hold for 10 seconds).
DATA OUT	Connects to the DATA IN port on the next cabinet.
POWER OUT	Connects the power cable to the next cabinet to support AC power.

Remote Control

- Using other display devices in the same space as the remote control of this product can cause the other display devices to be inadvertently controlled.
- A button without a description in the image below is not supported on the product.
- For Multy S-BOX (SNOW-1703U), the FREEZE function is applicable to only a still screen.

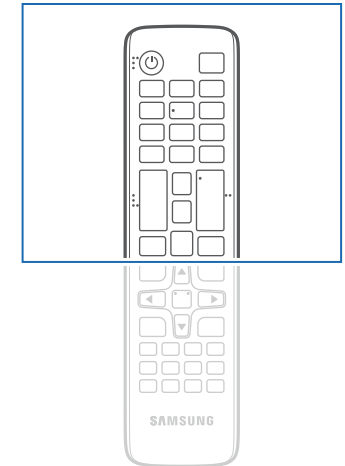
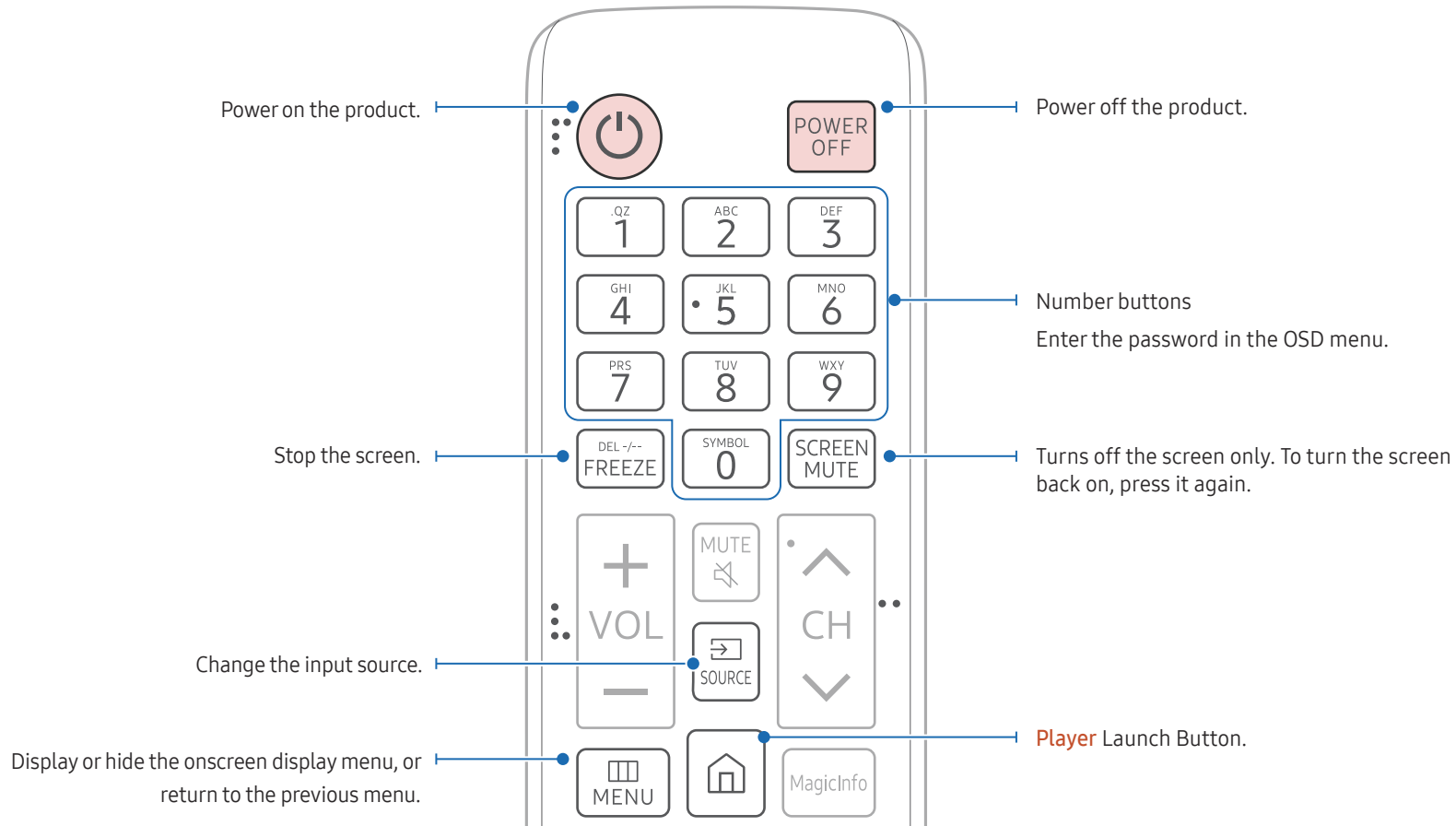

– Remote control button functions may differ for different products.

Quickly select frequently used functions.

Return to the previous menu.

Used in multimedia mode.

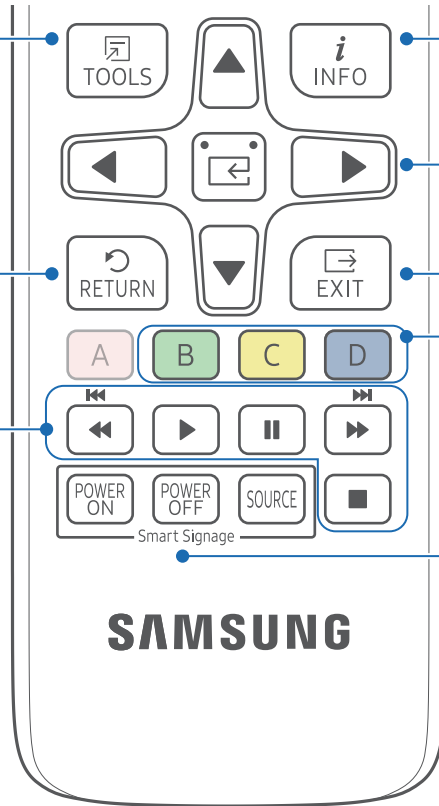

Display information about the current input source.

Move to the upper, lower, left or right menu, or adjust an option's setting.
Confirm a menu selection.

Exit the current menu.

B: Manually select a connected input source from **HDMI 1**.

C: Manually select a connected input source from **HDMI 2**.

D: Manually select a connected input source from **DisplayPort**.

POWER ON / POWER OFF

Turn on or off the Smart Signage device.

SOURCE

View or select an external device connected to the Smart Signage device.

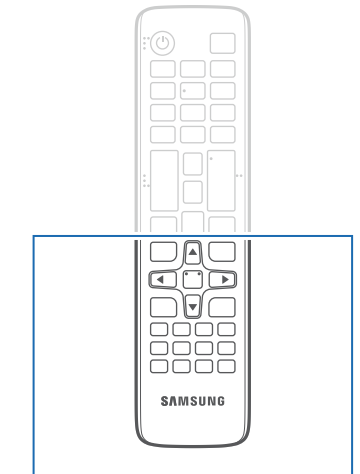

– Remote control button functions may differ for different products.

Press a button on the remote control pointing at the sensor on the front of the product to perform the corresponding function.

– Using other display devices in the same space as the remote control of this product can cause the other display devices to be inadvertently controlled.

Use the remote control within 7 m to 10 m from the sensor on the product at an angle of 30° from the left and right.

- Store used batteries out of reach of children and recycle.
- Do not use a new and used battery together. Replace both batteries at the same time.
- Remove batteries when the remote control is not to be used for an extended period of time.

To place batteries in the remote control

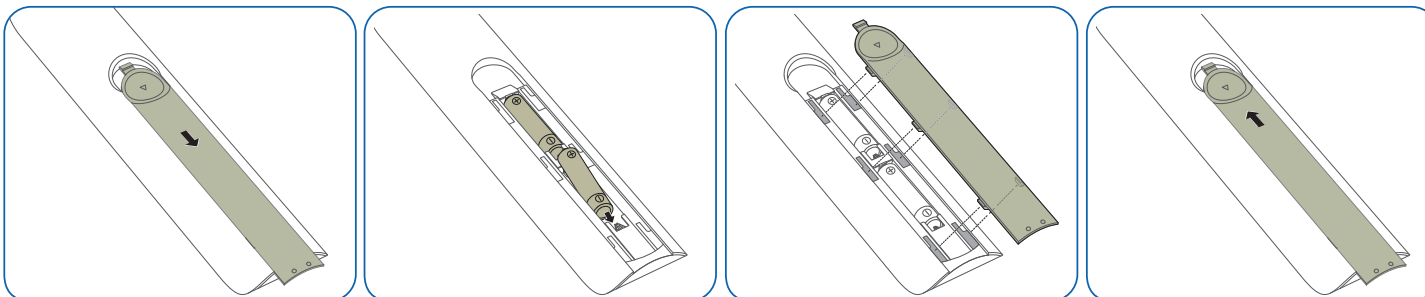

Remote Control (SNOW-1703U model only)

Cable Connection

RS232C Cable

Interface	RS232C (9 pins)
Pin	TxD (No.2), RxD (No.3), GND (No.5)
Bit rate	9600 bps
Data bits	8 bit
Parity	None
Stop bit	1 bit
Flow control	None
Maximum length	15 m (only shielded type)

- Pin assignment

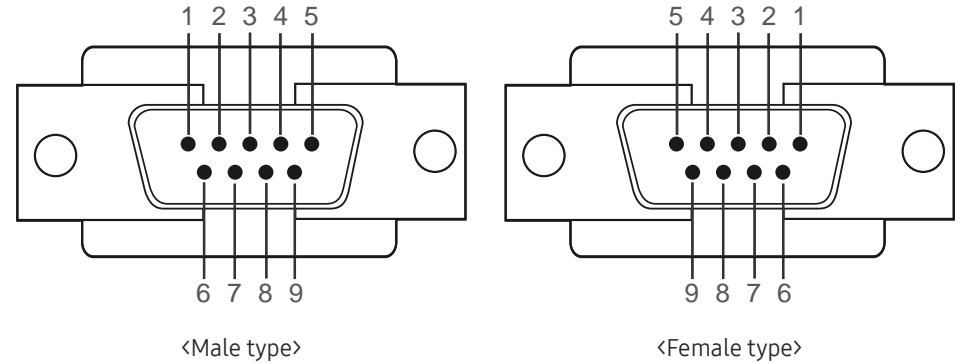

Pin	Signal
1	Detect data carrier
2	Received data
3	Transmitted data
4	Prepare data terminal
5	Signal ground
6	Prepare data set
7	Send request
8	Clear to send
9	Ring indicator

- RS232C cable
Connector: 9-Pin D-Sub to Stereo Cable

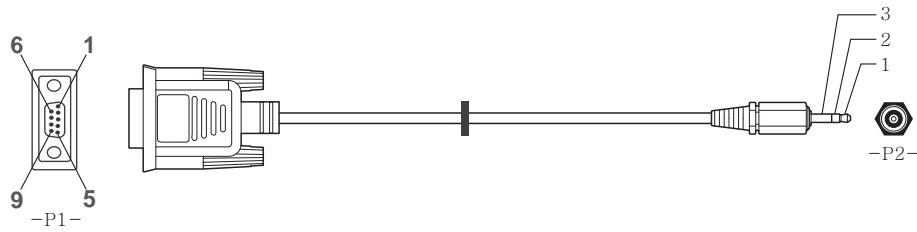

-P1-		-P1-		-P2-		-P2-	
Male type	Rx	3	-----	1	Tx	STEREO	
	Tx	2	-----	2	Rx	PLUG	
	Gnd	5	-----	3	Gnd	(3.5ø)	

LAN Cable

- Pin assignment

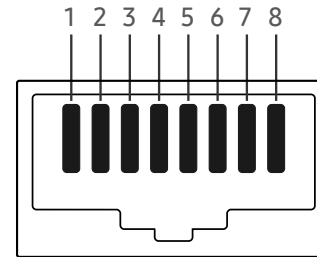

Pin No	Standard Color	Signal
1	White and orange	TX+
2	Orange	TX-
3	White and green	RX+
4	Blue	NC
5	White and blue	NC
6	Green	RX-
7	White and brown	NC
8	Brown	NC

- Connector : RJ45

Direct LAN cable (PC to HUB)

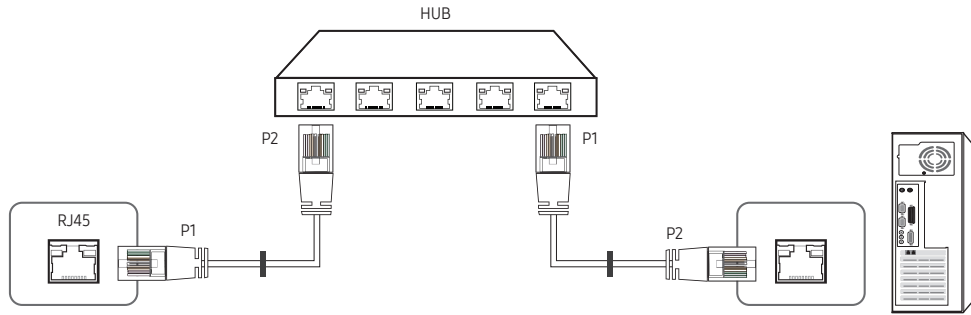

Signal	P1		P2	Signal
TX+	1	↔	1	TX+
TX-	2	↔	2	TX-
RX+	3	↔	3	RX+
RX-	6	↔	6	RX-

Cross LAN cable (PC to PC)

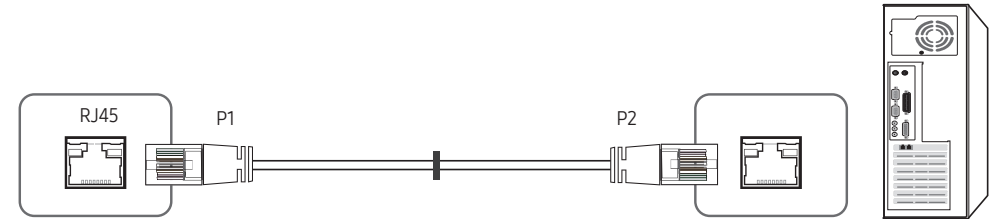

Signal	P1		P2	Signal
TX+	1	↔	3	RX+
TX-	2	↔	6	RX-
RX+	3	↔	1	TX+
RX-	6	↔	2	TX-

Connection

- Connection 1

— Ensure that you connect the RS232C(IN) adapter to the RS232C IN port on the product.

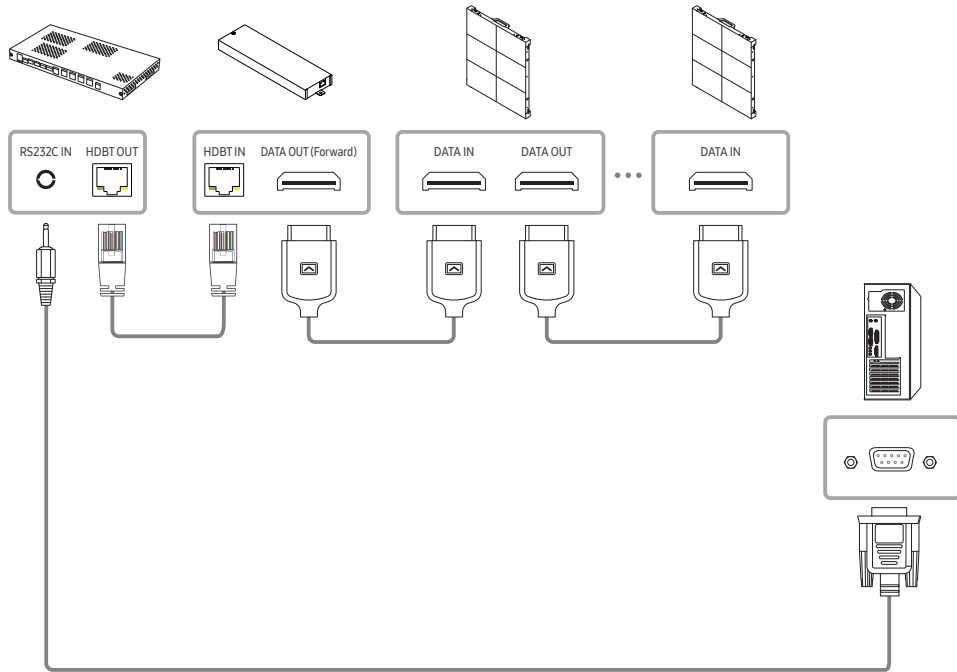

- Connection 2

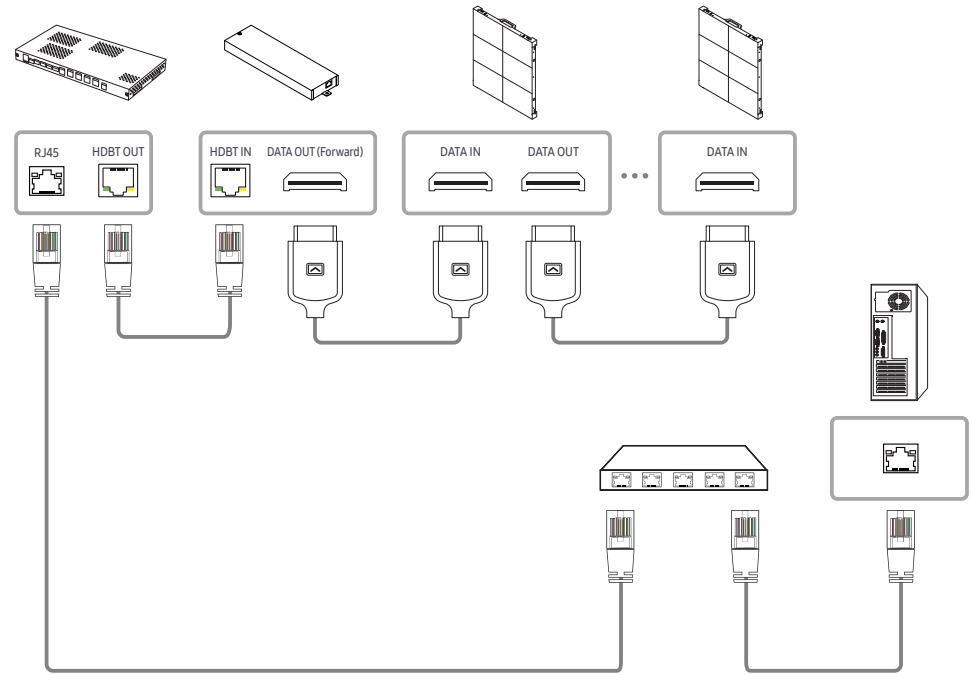

Control Codes

Viewing control state (Get control command)

Header	Command	ID	Data length	Checksum
0xAA	Command type		0	

Controlling (Set control command)

Header	Command	ID	Data length	Data	Checksum
0xAA	Command type		1	Value	

Command

No.	Command type	Command	Value range
1	Power control	0x11	0~1
2	Input source control	0x14	-
3	Screen mode control	0x18	-
4	Safety Lock	0x5D	0~1

- All communications take place in hexadecimals. The checksum is calculated by adding up all values except the header. If a checksum adds up to be more than 2 digits as shown below ($11+FF+01+01=112$), the first digit is removed.

E.g. Power On & ID=0

Header	Command	ID	Data length	Data 1	Checksum
0xAA	0x11		1	"Power"	

Header	Command	ID	Data length	Data 1	Checksum
0xAA	0x11		1	1	12

- To control all devices connected by a serial cable simultaneously irrespective of IDs, set the ID as "0xFE" and transmit commands. Commands will be executed by each device but ACK will not respond.

Power control

- Function
A product can be powered on and off using a PC.
- Viewing power state (Get Power ON / OFF Status)

Header	Command	ID	Data length	Checksum
0xAA	0x11		0	

- Setting power ON/Off (Set Power ON / OFF)

Header	Command	ID	Data length	Data	Checksum
0xAA	0x11		1	"Power"	

"Power": Power code to be set on a product.

1: Power ON

0: Power OFF

- Ack

Header	Command	ID	Data length	Ack/Nak	r-CMD	Val1	Checksum
0xAA	0xFF		3	'A'	0x11	"Power"	

"Power": Power code to be set on a product.

- Nak

Header	Command	ID	Data length	Ack/Nak	r-CMD	Val1	Checksum
0xAA	0xFF		3	'N'	0x11	"ERR"	

"ERR" : A code showing what error has occurred.

Input source control

- Function
The input source of a product can be changed using a PC.
- Viewing input source state (Get Input Source Status)

Header	Command	ID	Data length	Checksum
0xAA	0x14		0	

- Setting the input source (Set Input Source)

Header	Command	ID	Data length	Data	Checksum
0xAA	0x14		1	"Input Source"	

"Input Source": An input source code to be set on a product.

0x0C Input source At present, supports only reading the input source status.

0x21 HDMI1

0x23 HDMI2

0x25 DISPLAY PORT

0x60 MagicInfo

0x63 URL Launcher Operates only with URL Launcher.

0x65 Web Browser

— This model does not support HDMI1 and HDMI2.

— **MagicInfo** is only available with models that contain the **MagicInfo** function.

- Ack

Header	Command	ID	Data length	Ack/Nak	r-CMD	Val1	Checksum
0xAA	0xFF		3	'A'	0x14	"Input Source"	

"Input Source": An input source code to be set on a product.

- Nak

Header	Command	ID	Data length	Ack/Nak	r-CMD	Val1	Checksum
0xAA	0xFF		3	'N'	0x14	"ERR"	

"ERR" : A code showing what error has occurred.

Safety Lock

- Function
PC can be used to turn the **Safety Lock On** function on or off on a product. This control is available regardless of whether or not the power is turned on.
- Viewing the safety lock state (Get Safety Lock Status)

Header	Command	ID	Data length	Checksum
0xAA	0x5D		0	

- Enabling or disabling safety lock (Set Safety Lock Enable / Disable)

Header	Command	ID	Data length	Data	Checksum
0xAA	0x5D		1	"Safety Lock"	

"Safety Lock": Safety lock code to be set on a product

1: ON

0: OFF

- Ack

Header	Command	ID	Data length	Ack/Nak	r-CMD	Val1	Checksum
0xAA	0xFF		3	'A'	0x5D	"Safety Lock"	

"Safety Lock": Safety lock code to be set on a product

- Nak

Header	Command	ID	Data length	Ack/Nak	r-CMD	Val1	Checksum
0xAA	0xFF		3	'N'	0x5D	"ERR"	

"ERR": A code showing what error has occurred

Chapter 03

Connecting and using devices

Before Connecting

Pre-connection Checkpoints

- Before connecting a source device, read the user manual provided with it.
The number and locations of ports on source devices may differ from device to device.
- Do not connect the power cable until all connections are completed.
Connecting the power cable during connection may damage the product.
- Check the types of ports at the back of the product you want to connect.

Connecting to a PC

- Do not connect the power cable before connecting all other cables.
Ensure you connect a source device first before connecting the power cable.
 - A PC can be connected to the product in a variety of ways.
Select a connection method suitable for your PC.
- Connecting parts may differ in different products.

Connection Using an HDMI Cable

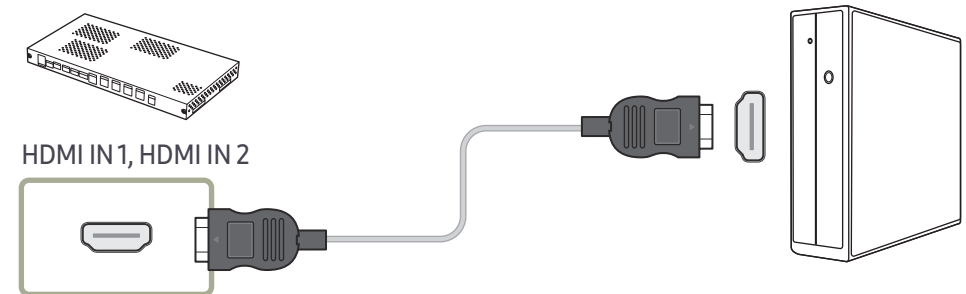

Connection Using an HDMI-DVI Cable

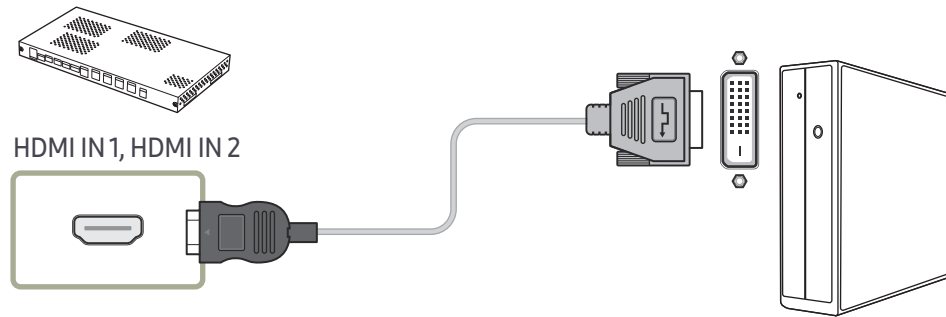

Connection Using an DP Cable

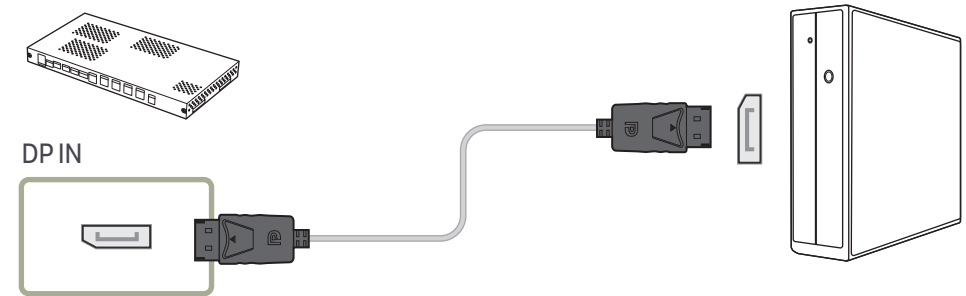

- Precautions for using DP
 - To increase the standby power capacity, the product stops DP communication when it is turned off or in power-saving mode.
If the product in dual monitor mode is turned off or goes into power-saving mode, monitor setting changes may not be updated. As a result, screen output may not be displayed properly.
In the occurrence of this issue, set **Max. Power Saving** to **Off** before using the product.
 - Some graphics cards that are not compliant with the DP standard may prevent the Windows Booting/Bios screen from being displayed when the product is in power-saving mode. If this is the case, make sure to turn on the product first before turning on your PC.
 - The DisplayPort interface (DP IN) on the product and the provided DP cable are designed based on the VESA standards. Using a DP cable that is not VESA compliant may cause the product to function improperly. Samsung Electronics shall not be held responsible for any issues from using a cable that is not VESA compliant.
Make sure to use a DP cable that is VESA compliant.

Connecting to a Video Device

- Do not connect the power cable before connecting all other cables.
Ensure you connect a source device first before connecting the power cable.
- You can connect a video device to the product using a cable.
 - Connecting parts may differ in different products.
 - Press the SOURCE button on the remote control to change the source.

Connection Using an HDMI-DVI Cable

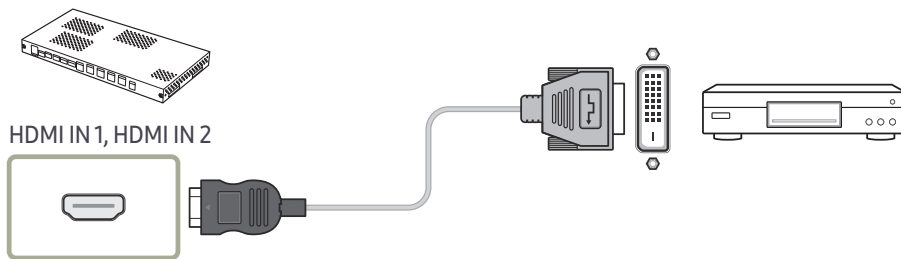

— Supported resolutions include 1080p (50/60Hz), 720p (50/60Hz), 480p, and 576p.

Connection Using an HDMI Cable

Using an HDMI cable or HDMI to DVI Cable (up to 1080p)

- For better picture and audio quality, connect to a digital device using an HDMI cable.
- If the product is connected to an external device that is compatible with an older HDMI version, the product may not display screen colors properly. It may also display a blank screen.
If such a problem occurs, ask the manufacturer of the external device about the HDMI version and, if out of date, request an upgrade.
- Be sure to use an HDMI cable with a thickness of 14 mm or less.
- Be sure to purchase a certified HDMI cable. Otherwise, the picture may not display or a connection error may occur.
- A basic high-speed HDMI cable or one with ethernet is recommended.
This product does not support the ethernet function via HDMI.

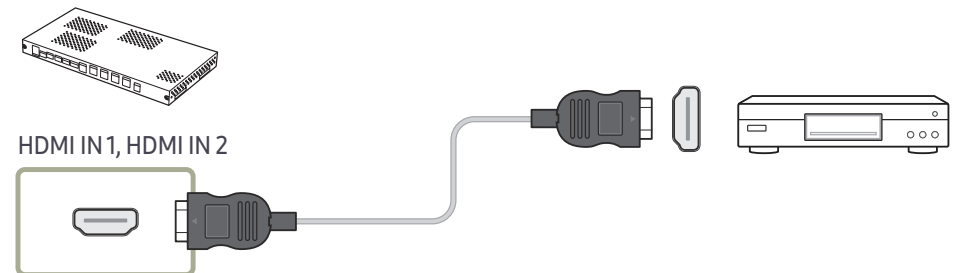

Connecting the LAN Cable

— Connecting parts may differ in different products.

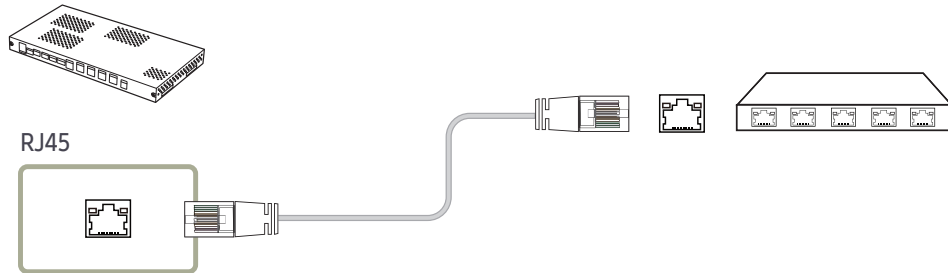

- Use a cable of CAT 6 (*FTP type) or higher.
*FTP: Foiled Twisted Pair

— Connect to a HUB or router that supports the HDCP function.

SNOW-1703U Installation Precautions

Do not install the SNOW-1703U model on its side or upside down.

When stacking, keep the vertical distance between products at least 10 mm.

When installing on a wall, keep all distances between the wall and the top, bottom, left, right sides of the product at least 10 mm.

When installing on a wall, keep the distance between the wall and the ports on the back of the product at least 50 mm or more for cable connection.

Make sure that the ambient temperature inside the rack mount does not exceed 35°.

When installing SNOW-1703U, do not block the air vent on the top to prevent the product from overheating.

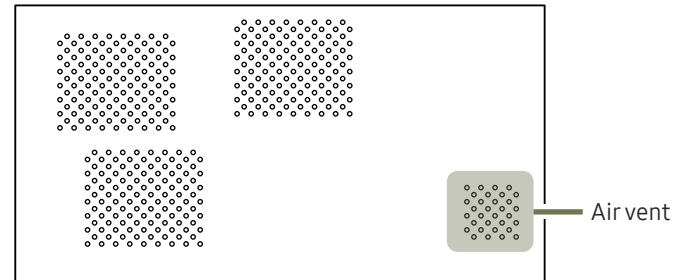

Installing the cabinets

Install the cabinet using the frame kit provided by the manufacturer.

For more information about how to install the frame kit, refer to the user manual that comes with it.

Samsung Electronics shall not be liable for any damage to the product and any injury to the users or others that may be incurred while the users install the product by themselves.

— The color and shape of parts may differ from what is shown. Specifications are subject to change without notice to improve quality.

Removing the protective brackets

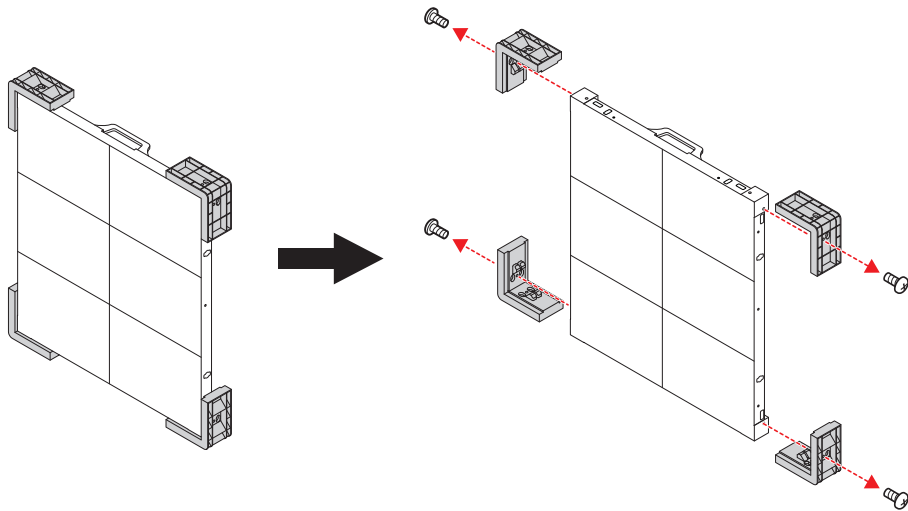

Replacing the cabinet module

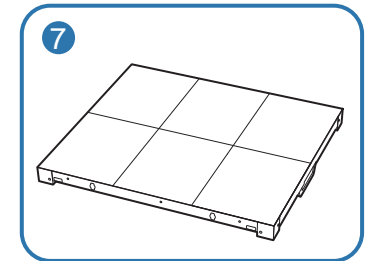
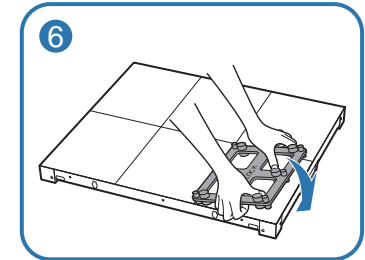
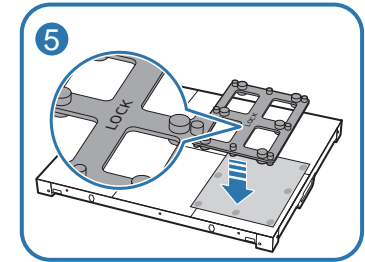
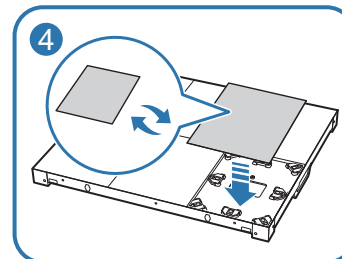
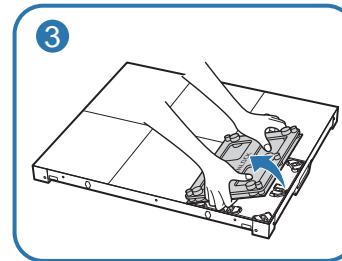
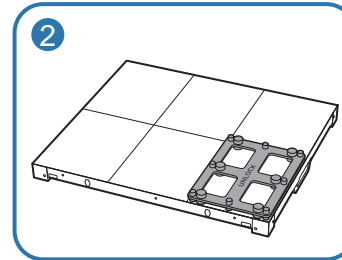
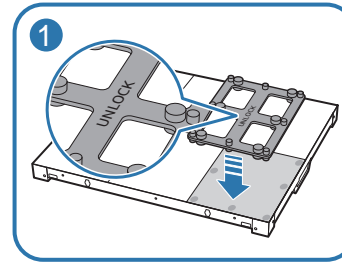

Precautions when handling the cabinets

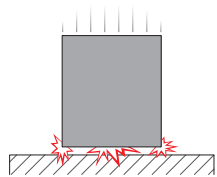

[Caution to prevent external shock and dropping of the product]

After removing the protective brackets, be careful not to expose the product to external shocks or vibrations. Make sure that the product is not dropped from any height.

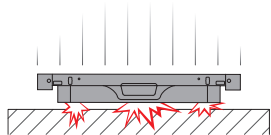

Be careful not to expose the product to vibrations or external shocks when it is lying flat on the floor.

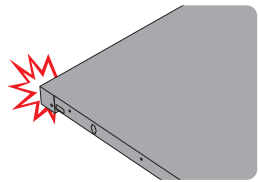

[Caution to prevent damage to corners]

Take extra care to ensure that the corners of a cabinet do not get damaged.

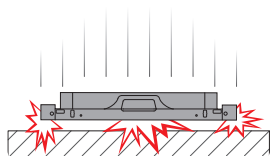

After removing the protective brackets, do not place the product on the floor with the LED facing down.

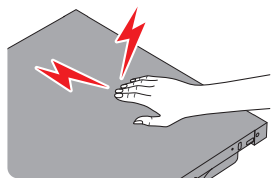

[Caution to prevent damage to the LED from static]

Do not touch the product without anti-static gloves.

Restrictions when installing cabinets

One SNOW-1703U supports up to UHD resolution because it has four built-in HDBT OUT ports.

Up to 72 IF015Hs, up to 128 IF020Hs, and up to 200 IF025Hs can be installed per SNOW-1703U.

You can enjoy image quality of Full HD resolution only when IF015Hs are installed in 3 * 6 layout, IF020Hs 4 * 8, or IF025Hs 5 * 10.

You can enjoy image quality of UHD resolution only when IF015Hs are installed in 3 * 6 * 4 layout, IF020Hs 4 * 8 * 4, or IF025Hs 5 * 10 * 4. (Full HD layout * 4 HDBT OUT ports)

To enjoy resolutions that exceed UHD resolution, you need to add SNOW-1703Us to the configuration.

SNOW-1703U displays the screen starting from the upper left cabinet. To view the screen, connect the HDBT cable to the HDBT OUT1 port on SNOW-1703U.

IF015H

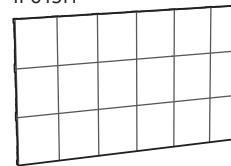

IF020H

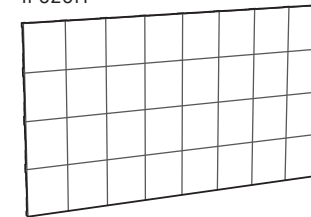

IF025H

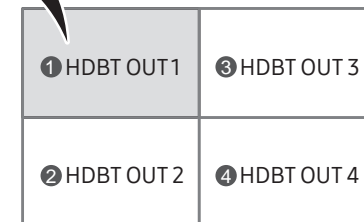
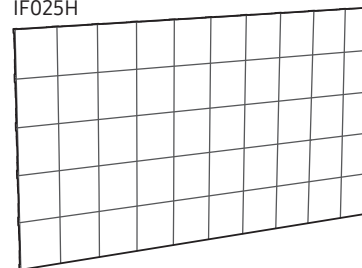

— To enjoy image quality of UHD resolution, be sure to install the cabinets in alignment with the HDBT OUT layout.

(①: HDBT OUT 1, ②: HDBT OUT 2, ③: HDBT OUT 3, ④: HDBT OUT 4)

Connecting to cabinets

- Connect SNOW-1703U to an external device, and then connect it to IF015H, IF020H or IF025H devices.
- Connecting parts may differ in different products.
 - Do not connect the power cable before connecting all other cables. Ensure you connect a source device first before connecting the power cable.
 - Before connecting power to the cabinets, connect the I/G card to the cabinets first.
 - One SNOW-1703U supports only one type of LED pitch cabinets. Do not connect different types of LED pitch cabinets.
- Connecting other types of cabinets may cause abnormal image quality.
 - After connecting the HDBT cable, connect the OCM cable in the following order:

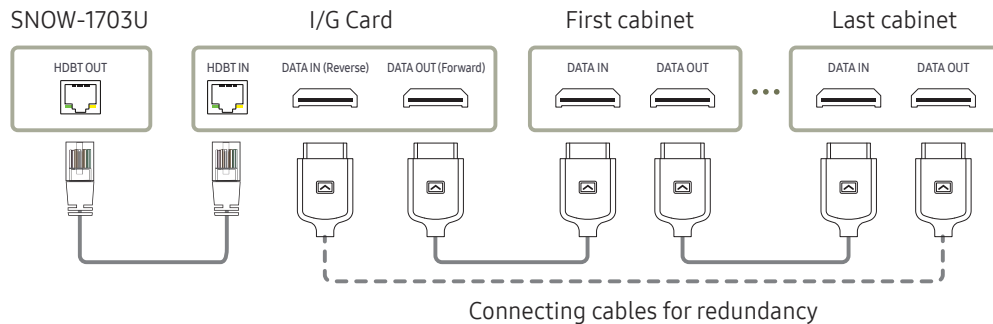

- Use a cable of CAT 6 (*FTP type) or higher.
*FTP: Foiled Twisted Pair
- Make sure that the HDBT cable length is from 15 m to 100 m.
- If you use a cable that is out of specified length range, the signal quality may be unstable.

Recommended number of devices for connection for each input voltage

- If using 110 V, you can connect at most 3 IF015H devices, 3 IF020H devices or 4 IF025H devices.
 - If using 220 V, you can connect at most 4 IF015H devices, 4 IF020H devices or 8 IF025H devices.
- Exceeding the recommended maximum number of devices can cause the circuit breaker of the product to trigger due to overload.

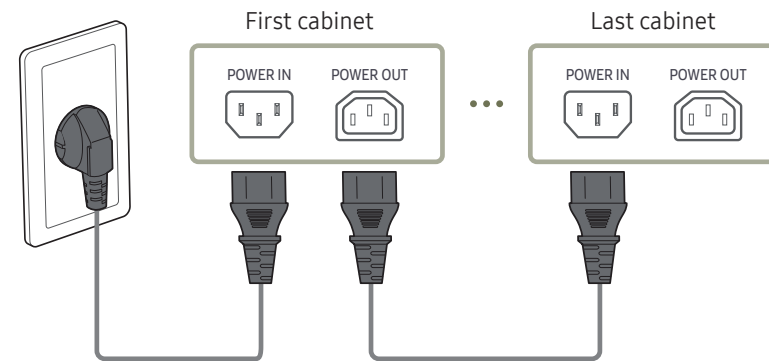

Changing the Input source

Source

☰ SOURCE → Source



– The displayed image may differ depending on the model.

Source allows you to select a variety of sources and change source device names.

You can display the screen of a source device connected to the product. Select a source from source list to display the screen of the selected source.

- The input source can also be changed by using the **SOURCE** button on the remote control.
- The screen may not display correctly if an incorrect source is selected for the source device you want to convert to.

Edit

☰ SOURCE → Source → ▲ → Edit → ↻

Edit the name and device type of a connected external device.

- The list can include the following source devices. Source devices on the list differ depending on the selected source.
HDMI 1 / HDMI 2 / DisplayPort / Cable Box / Game Console / PC / Blu-ray player
- You cannot edit the following sources.
MagicInfo S / URL Launcher / Web Browser

Information

INFO

You can see detailed information about the selected external device.

Web Browser

☰ SOURCE → Source → Web Browser → ☰

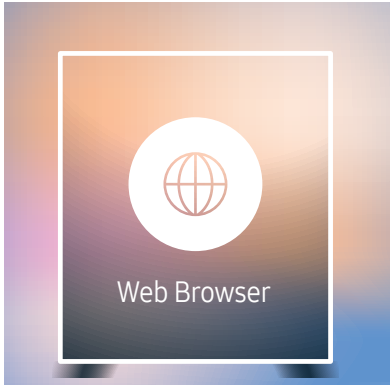

- The displayed image may differ depending on the model.
- Connect a LAN cable to access Internet from the product, similar to accessing the Internet from a computer.

Settings

☰ SOURCE → Source → Web Browser → ▲ → Settings → ☰

General

Hide Tabs and Toolbar automatically

If the browser tabs, menu or toolbar are not used for a while, they will automatically disappear. To make them appear again, move the pointer or focus to the top of the screen.

- Use / Do not use

Pop-up Blocker

Make your browsing experience more pleasant by blocking pop-up windows.

- Use / Do not use

Reset Settings

All your customized web browser settings will be reset to their default values. Your bookmarks and history won't be affected.

Search Engine

If you enter a keyword in the URL/keyword input field, Web Browser will open the Search Results page.

Choose the search engine you want to use.

- Google / Bing

Privacy & Security

Security Mode

Provide warnings about unsafe pages or block access to enhance Web Browser security. This may slow the Web Browser down.

- Use / Do not use

Private Browsing

When Private Browsing is active, your browsing history won't be recorded.

- Use / Do not use

Do Not Track

Ask websites not to track you.

- Use / Do not use

JavaScript

Allow all sites to run JavaScript for a better browsing experience.

- Use / Do not use

Clear History

Clear your entire browsing history.

Delete browsing data

Delete all browsing data such as cookies, cached images and data. Your Bookmarks and History won't be affected.

Blocked pages

Blocked pages

Block access to pages that you have listed in Blocked pages.

- Use / Do not use

List of Blocked Pages

Block or unblock specific pages.

- Add

Approved pages

Approved pages

Enable web access only to pages that you have approved.

- Use / Do not use

Password for Approved pages

Set a password for managing Approved pages.

- Set Password

List of Approved Pages

Approve specific pages or remove them from Approved pages.

- Add

Encoding

Encoding

Choose an encoding method for web pages. The current setting is Auto.

- Auto / Manual (Current : Unicode)

About

Display the current version of Web Browser.

Refresh Options

☰ SOURCE → Source → Web Browser → ▲ → Refresh Options → ☰

Refresh Interval

Set the time for the web browser to wait before returning to the home page.

- Off / 5 min / 10 min / 15 min / 30 min

Zoom

Set the zoom scale to apply when the web browser is refreshed.

- 50% / 75% / 100% / 125% / 150% / 200% / 300%

Home Page

Set the website to display when the web browser is refreshed.

- Samsung Display / Custom

Custom

Enter the URL to set as the home page.

- Enter URL
 - Available only when Home Page is set to Custom.

Chapter 04

Using LED Signage Manager

The LED Signage Manager software allows you to easily control multiple display devices from your computer.

For details on how to use the LED Signage Manager software, refer to the Help after installing the software. The LED Signage Manager software is available on the website.

- The installation process for LED Signage Manager may be affected by the graphics card, motherboard, and network environment.
- Make sure that Windows 7 or higher and Microsoft .NET Framework 4.5 are installed on the computer, before installing LED Signage Manager.
- SNOW-1703U does not support the [Auto Detect](#) function.

Chapter 05

Player feature

Accessible using the  button on the remote control.

Player

 → **Player** → 

Play a range of content such as channels with schedules assigned, templates or files.

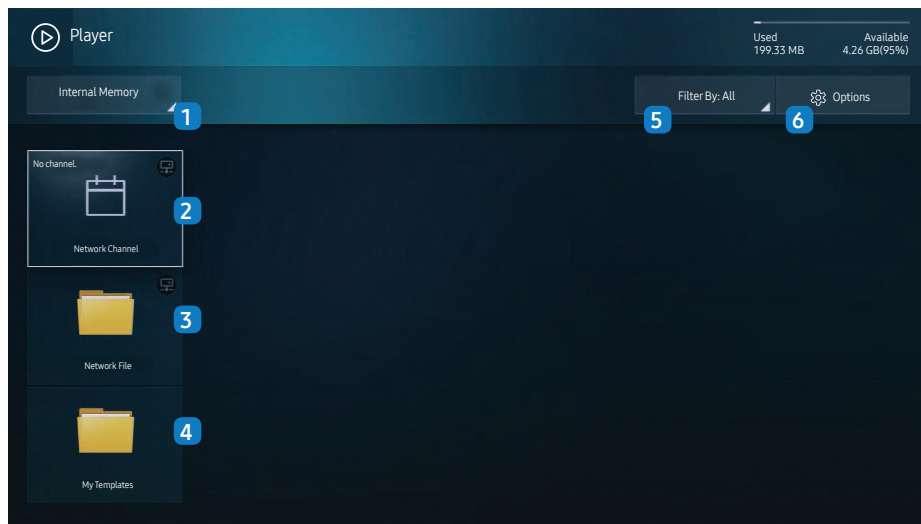

- The displayed image may differ depending on the model.
- To use the **Player** feature, set **Play via** to **MagicInfo** in **System**.

No. Description

- 1 Select between internal or external memory.
- 2 Play content, templates and schedules configured on the server.
 - You can view whether the server is connected (approval) in the **Player** screen. To view whether the server is connected when a Network Channel is running, press **INFO** on the remote.
- 1 Select **Network Channel** from the **Player** screen. The **No channel.** message appears if no channel has been registered in **Network Channel**.
- 2 **Network Channel** will run.
- 3 Play content stored on the server.
- 4 Play a template stored in the internal memory.
- 5 Select a content type as criterion to search for a desired content list.
- 6 Set different options for **Player**.

Viewing content

- 1 Select either internal or external memory. The files saved in the selected memory appear.
- 2 Select the desired file. The content appears on the screen. (For more information on compatible file formats, see the "File formats compatible with Player" section.)

When content is running

Control buttons on the remote

You can use buttons on your remote control to play, pause, or skip between content on the playlist.

Button	Function
TOOLS	Brings up the menu bar.
INFO	Displays the information of the content.
▶	Goes to next file or page.
◀	Goes to previous file or page.
⏪ / ▶ / ⏸	Plays or pauses slide show or video content.
■	Stops displaying content and goes to the Player screen.
◀◀	Rewinds the video content.
▶▶	Fast forwards the video content.

Available menu

Press the TOOLS button on the remote control during content playback to configure settings.

Menu	Description
Playlist	View a list of content items currently playing.
Channel List	Network Channel / Internal Channel / USB
Picture Mode	Customizes the screen settings for the content currently playing.
Repeat	Set the repeat mode.

— SNOW-1703U does not support the sound function.

File Formats Compatible with Player

- Supported file systems include FAT32 and NTFS.
- A file with a vertical and horizontal resolution larger than the maximum resolution cannot be played.
Check the vertical and horizontal resolution of the file.
- Check supported video codec types and versions.
- Check the supported file versions.
 - PowerPoint version up to 97 – 2007 is supported
- Only the last USB device that was connected is recognized.

Network Schedule Multiframe

Playback restrictions

- A maximum of two video files (**Video**) can be played simultaneously.
- In portrait playback mode, only one video file can be played at a time.
- For **Office** files (PPT and Word files) and **PDF** files, only one file type is supported at a time.
- LFD(.lfd) files are not supported.

Template files and LFD(.lfd) files

Restrictions

- Ensure a distributed folder (content / schedules) exists in **Internal Memory** / **USB** memory.

Playback restrictions

- A maximum of two video (**Video**) files can be played.
- For **Office** files (PPT and Word files) and **PDF** files, only one file type is supported at a time.
- Multiple videos (**Video**) cannot be played on a single display of a video wall simultaneously.

Contents

File Extension	Container	Video Codec	Resolution	Frame rate (fps)	Bit rate (Mbps)		
*.avi	AVI	H.264 BP/MP/HP	4096x2160	4096X2160: 24	40		
*.mkv	MKV			3840X2160: 30			
*.asf	ASF	HEVC (H.265 - Main, Main10, Main4:2:2 10)		60	80		
*.wmv	MP4	Motion JPEG		30	80		
*.mp4	3GP						
*.mov	MOV	MVC	1920x1080	60	20		
*.3gp	FLV	MPEG4 SP/ASP					
*.vro	VRO	Window Media Video v9 (VC1)					
*.mpg	VOB	MPEG2					
*.mpeg	PS	MPEG1					
*.ts	TS						
*.tp	SVAF	Microsoft MPEG-4 v1, v2, v3				30	20
*.trp		Window Media Video v7(WMV1),v8(WMV2)					
*.mov		H 263 Sorenson					
*.flv							
*.vob		VP6					
*.svi							
*.m2ts							
*.mts							
*.webm	WebM	VP8	1920x1080	90	20		
		VP9	4096x2160	4096X2160: 24 3840X2160: 30	20		
*.rmvb	RMVB	RV8/9/10 (RV30/40)	1920x1080	60	20		

Video

- 3D video is not supported.
- Content with a resolution larger than the resolution specified in the table above is not supported.
- Video content with a Bit rate or Frame rate larger than the rate specified in the table above can cause choppy video during playback.
- Video content will not play, or not play correctly, if there is an error in the content or the container.
- Some USB/digital camera devices may not be compatible with the player.
- Supports up to H.264, Level 4.1
- H.264 FMO / ASO / RS, VC1 SP / MP / AP L4 and AVCHD are not supported.
- For all Video codecs except MVC, VP8, VP6:
 - Below 1280 x 720: 60 frame max
 - Above 1280 x 720: 30 frame max
- GMC 2 or higher is not supported.
- Supports only BD MVC Spec.
- Only one video file can play at a time if video files on the monitor use incompatible codecs or the resolution is 1080 x 1920.
- When a single video file is playing, Seamless mode is not supported under the following conditions:
 - Incompatible codec (MVC, VP3, MJPEG) ↔ Incompatible codec
 - Incompatible codec ↔ Compatible codec
 - The resolution is different from that of the monitor
 - The frequency is different from that of the monitor

Image

- Compatible image file format : JPEG, PNG, BMP
 - 32-bit, 24-bit and 8-bit BMP files are supported.
- Supported maximum resolution : 4096 x 4096
- Supported maximum file size: 20MB
- Supported image effects : 9 effects
(**Fade1, Fade2, Blind, Spiral, Checker, Linear, Stairs, Wipe, Random**)

Power Point

PDF

WORD

- Compatible document file formats
 - Extension : ppt, pptx
 - Version : Office 97 ~ Office 2007
- Functions not supported
 - Animation effect
 - 3D shapes (which will be displayed in 2D)
 - Header and footer (some subitems are not supported)
 - Word Art
 - Align
 - A group alignment error may occur
 - Office 2007
 - SmartArt is not fully supported. 97 out of 115 subitems are supported.
 - Object insertion
 - Half-width characters
 - Letter spacing
 - Charts
 - Vertical text
 - Some subitems are not supported
 - Slide notes and handout

- Compatible document file formats
 - Extension : pdf
- Functions not supported
 - Content less than 1 pixel not supported because of performance degradation issue.
 - Masked Image, Tiled Image content not supported.
 - Content with Rotated Text, not supported.
 - 3D Shadow Effects not supported.
 - Some characters not supported (Special characters may be corrupted)

- Compatible document file formats
 - Extension : .doc, .docx
 - Version : Office 97 ~ Office 2007
- Functions not supported
 - Page background effect
 - Some paragraph styles
 - Word Art
 - Align
 - A group alignment error may occur
 - 3D shapes (which will be displayed in 2D)
 - Office 2007
 - SmartArt is not fully supported. 97 out of 115 subitems are supported.
 - Charts
 - Half-width characters
 - Letter spacing
 - Vertical text
 - Some subitems are not supported
 - Slide notes and handout

Template files

- Creation/editing/playback are only available in **My Templates**.

LFD

- Supported in **Network Channel**
- Compatible document file formats
 - Extension : .lfd

Schedule

🏠 → Schedule → 📅

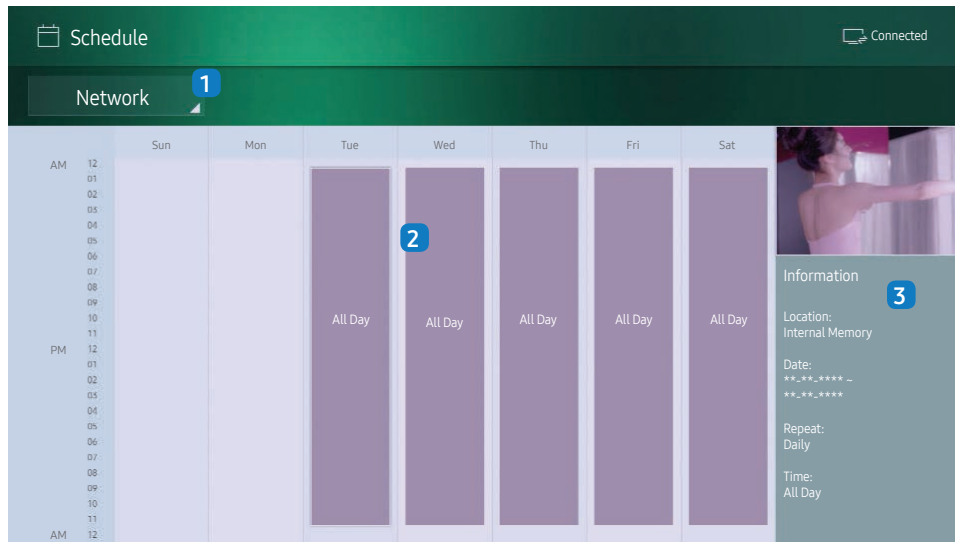

– The displayed image may differ depending on the model.

You can check the content's playback schedule on the server, imported from an external storage, or on a mobile device.

No.	Description
1	Select between server and external memory.
2	View weekly schedule of content playback. Select to view detailed information of each event.
3	View a thumbnail image and brief information of the content.

Clone Product

🏠 → Clone Product → 🗑️

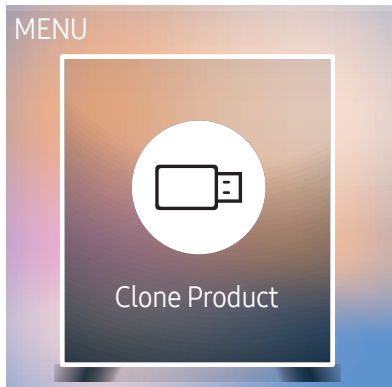

– The displayed image may differ depending on the model.

Export settings on the product to an external storage device. You can also import settings from an external storage device.

This option is useful when assigning the same settings to several products.

When a duplicate file is not found on the external storage device

- 1 Connect the external storage device, then run the **Clone Product** function.
- 2 The **No cloning file found on the external storage device. Export this device's settings to the external storage device?** message appears.

When a duplicate file is found on the external storage device

- 1 Connect the external storage device, then run the **Clone Product** function.
- 2 The **Cloning file found. Please select an option.** message appears.

Run the **Clone from external storage device** or **Clone to external storage device** function.

- **Clone from external storage device:** Copy settings saved on an external storage device to the product.
- **Clone to external storage device:** Copy settings on the product to an external storage device.

– After configuration is complete, the product is rebooted automatically.

ID Settings

Home → ID Settings →

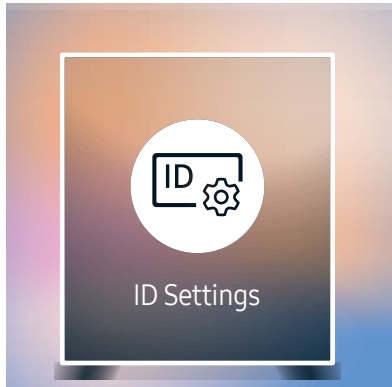

– The displayed image may differ depending on the model.

Assign an ID to a set.

Device ID

Enter the ID number of the product connected to the input cable for input signal reception. (Range: 0~224)

- Press ▲/▼ to select a number, and press .
- Enter the number you want using the number buttons on the remote control.

PC Connection Cable

Select a method to connect to MDC to receive the MDC signal.

- **RS232C cable**
Communicates with the MDC via a RS232C cable.
- **RJ-45 (LAN)/Wi-Fi Network**
Communicate with MDC via the RJ45 cable.

Video Wall

🏠 → Video Wall → 📺

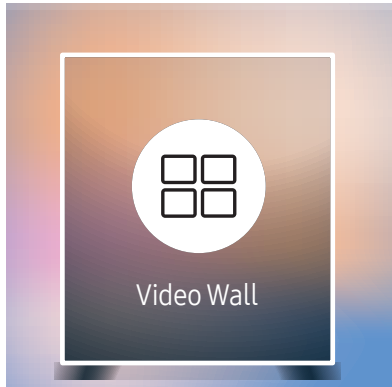

- The displayed image may differ depending on the model.
- For the supported resolutions, refer to the S-Box Group Supported items in the Standard Signal Modes table on [page 93](#).

Customize the layout of multiple S-boxes that are connected to form a LED display.

In addition, display part of a whole picture or repeat the same picture on each of the connected multiple S-boxes.

To display multiple images, refer to MDC Help or the MagicInfo user guide. Some models may not support the MagicInfo function.

Video Wall

You can activate or deactivate **Video Wall**.

When using multiple S-Boxes, you can set **Video Wall** to **On** to synchronize and display the S-Box outputs as a single content.

- **Off / On**

Horizontal x Vertical

This feature automatically splits a display based on a videowall matrix configuration.

Enter the videowall matrix.

The display is split based on the configured matrix. The number of vertical or horizontal S-boxes can be set within the range of 1 to 15.

- A display can be split into a maximum of 100 screens.
- The **Horizontal x Vertical** option is only enabled when **Video Wall** is set to **On**.

Screen Position

To rearrange split screens, adjust the number for each product in the matrix using the **Screen Position** feature.

Selecting **Screen Position** will display the videowall matrix with the numbers assigned to the products that form the videowall.

To rearrange products, use the direction buttons on the remote control to move a product to another desired number. Press the  button.

- **Screen Position** allows you to split the screen into a maximum of 100 views (15x15). The maximum number of views that can be split when products are connected via DP Loopout is also 100.
- The **Screen Position** option is only enabled when **Video Wall** is set to **On**.
- To use the function, make sure **Horizontal x Vertical** is configured.

Format

Select how to display images on the LED display.

- **Full:** Display images in full screen with no margin.
- **Natural:** Display images in the original aspect ratio without enlarging or reducing the size.

— The **Format** option is only enabled when **Video Wall** is set to **On**.

Network Status

Check the current network and Internet connection.

🏠 → Network Status → 📄

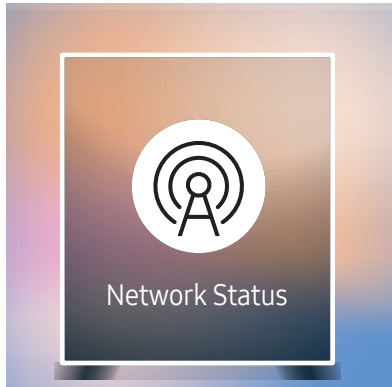

– The displayed image may differ depending on the model.

Picture Mode

🏠 → Picture Mode → 🖥️

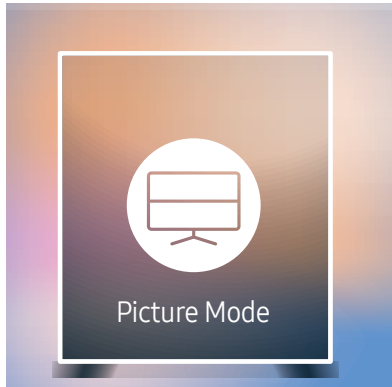

– The displayed image may differ depending on the model.

Select a picture mode (**Picture Mode**) suitable for the environment where the product will be used.

Video/Image mode improves the picture quality of the video device. **Text** mode improves the picture quality of the computer.

- **Shop & Mall**
Suitable for shopping malls.
 - Select either **Video/Image** or **Text** depending on the picture mode.
- **Office & School**
Suitable for offices and schools.
 - Select either **Video/Image** or **Text** depending on the picture mode.
- **Terminal & Station**
Suitable for bus terminals and train stations.
 - Select either **Video/Image** or **Text** depending on the picture mode.
- **Video Wall**
Suitable for environments where videowall display are used.
 - Select either **Video/Image** or **Text** depending on the picture mode.
- **Calibration**
In this mode, the brightness, color, gamma and uniformity settings customized using the color calibration program **Advanced Color Management** are applied.
 - To apply the **Calibration** mode properly, make sure you configure the picture quality settings, such as brightness, color, gamma and uniformity, using the color calibration program **Advanced Color Management**.
 - To download the **Advanced Color Management** program, visit www.samsung.com/displaysolutions.

On/Off Timer

🏠 → On/Off Timer → 📄



– The displayed image may differ depending on the model.

– You must set **Clock Set** before you can use this feature.

On Timer

Set **On Timer** so that your product turns on automatically at a time and on a day of your choosing.

The product turns on according to the settings of the specified input source.

On Timer: Set the on timer by making a selection from one of the seven options. Ensure you set the current time first.

(On Timer1 ~ On Timer7)

- **Setup:** Select **Off**, **Once**, **Everyday**, **Mon~Fri**, **Mon~Sat**, **Sat~Sun** or **Manual**.
 - If you select **Manual**, you can choose the days you want **On Timer** to turn on your product.
 - The check mark indicates days you've selected.
- **Time:** Set the hour and minute. Use the number buttons or the up and down arrow keys to enter numbers. Use the left and right arrow buttons to change entry fields.
- **Source:** Select the input source of your choice.
- **Content** (when the **Source** is set to **Internal/USB**): From the connected USB device or the internal memory device, select a folder containing the video or photo file that will be played when the product turns on.
 - This function is available only when a USB device is connected.
 - If there is only one photo file in the USB, the **Slide Show** will not play.
 - If a folder name is too long, the folder cannot be selected.
 - Each USB you use is assigned its own folder. When using more than one of the same type of USB, make sure the folders assigned to each USB have different names.
 - We recommend that you use a USB memory stick and a multi card reader when using **On Timer**.
 - The **On Timer** function may not work with USB devices with a built-in battery, MP3 players, or PMPs made by some manufacturers because the product can take too long to recognize these devices.

Off Timer

Set the off timer (**Off Timer**) by making a selection from one of the seven options. (**Off Timer 1 ~ Off Timer 7**)

- **Setup:** Select **Off**, **Once**, **Everyday**, **Mon~Fri**, **Mon~Sat**, **Sat~Sun** or **Manual**.
If you select **Manual**, you can choose the days you want **Off Timer** to turn off your product.
 - The check mark indicates days you've selected.
- **Time:** Set the hour and minute. Use the number buttons or the up and down arrow keys to enter numbers. Use the left and right arrow buttons to change entry fields.

Holiday Management

Timer will be disabled during a period specified as a holiday.

- **Add Holiday:** Specify the period you want to add as a holiday.
Select the start and end dates of the holiday you want to add using the ▲/▼ buttons, and click the **Done** button.
The period will be added to the list of holidays.
 - **Start:** Set the start date of the holiday.
 - **End:** Set the end date of the holiday.
- **Delete:** Delete selected items from the list of holidays.
- **Edit:** Select a holiday item and then change the date.
- **Set Applied Timer:** Set the **On Timer** and **Off Timer** to not activate on public holidays.
 - Press to select the **On Timer** and **Off Timer** settings you do not want to activate.
 - The selected **On Timer** and **Off Timer** will not activate.

Ticker

🏠 → Ticker → 📄

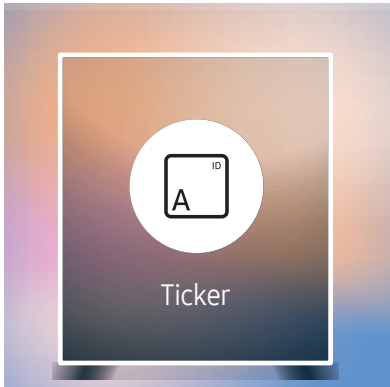

Input text while a video or image is displayed and display the text on the screen.

- **Off / On**
- **Message:** Enter a message to display on the screen.
- **Time:** Set the **Start Time** and **End Time** to display a **Message**.
- **Font Options:** Specify the text font and color for the message.
- **Position:** Select an orientation to display a **Message**.
- **Scroll:** Specify the scroll **Direction** and **Speed** for the message.
- **Preview:** Preview configured caption settings.

– The displayed image may differ depending on the model.

URL Launcher

🏠 → URL Launcher → 📄

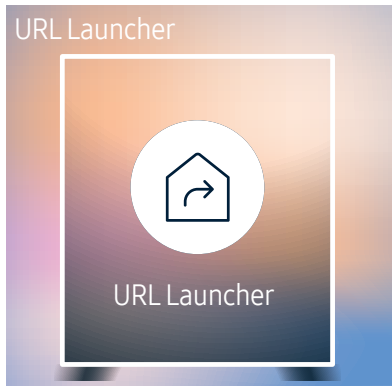

– The displayed image may differ depending on the model.

For details on how to use the **URL Launcher** feature, contact the dealer the product was purchased from.

– To use the **URL Launcher** feature, set **Play via** to **URL Launcher** in **System**.

URL Launcher Settings

🏠 → URL Launcher Settings → ⌘

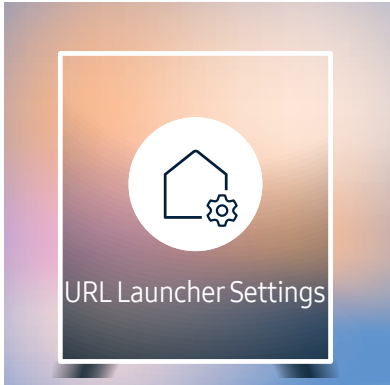

- **Install Web App:** Enter URL to install the web application.
- **Install from USB Device:** Install the web application from the USB storage device.
- **Uninstall:** Remove the installed web application.
- **Timeout Setting:** Set the timeout period for connecting to the URL.
- **Developer Mode:** Enable developer mode.

– The displayed image may differ depending on the model.

Approving a connected device from the server

First configure the server **Server Network Settings** before device approval.

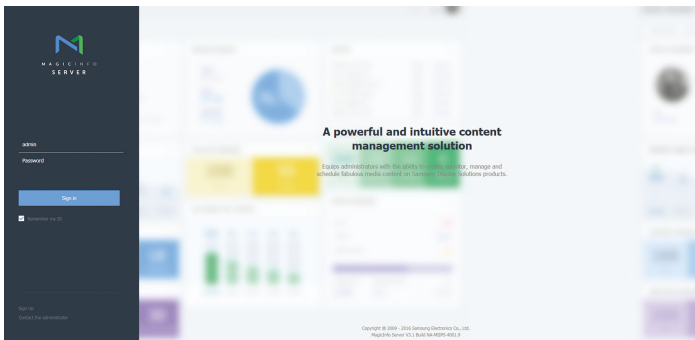

- 1 Access the server you have assigned to your device.
- 2 Enter your ID and password to log in.

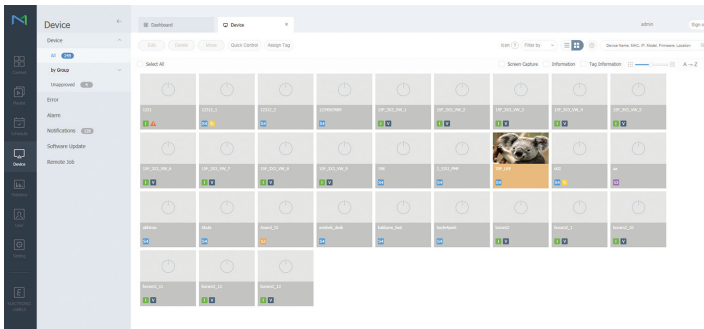

- 3 Select **Device** from the top menu bar.

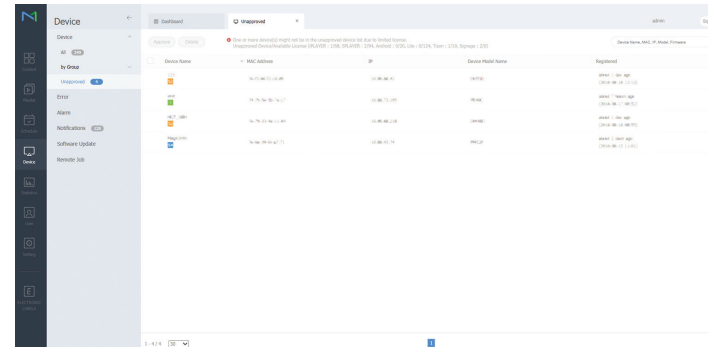

- 4 Select **Unapproved** from the sub-menus.
- 5 Select the device from the list and click the **Approve** button.

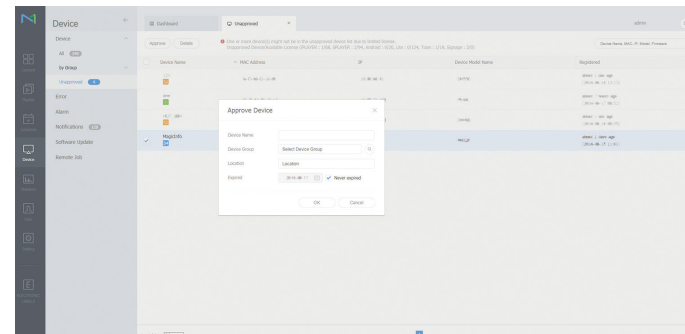

- 6 Enter the information required to approve the device.
 - **Device Name:** Enter the device name.
 - **Device Group:** Select **Q** to specify the group.
 - **Location:** Enter the current location of the device.
 - **Expired:** Set expiry date for the device's approval. If you do not want to set the expiry date, select **Never expired**.
 - Pressing the **INFO** button on the remote when a network schedule is running will display the details of the schedule. Check that the correct device has been selected by viewing the device ID in the details.

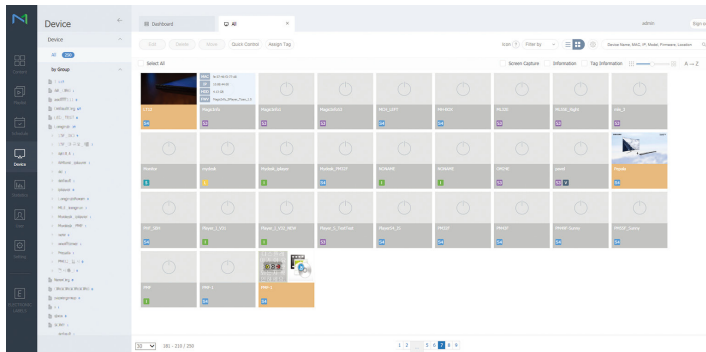

7 Select the **All** menu to check that the device has been registered.

8 When the device is approved by the server, the schedule registered in the selected group will be downloaded to the device. The schedule will run after it is downloaded.

— For further details on how to configure a schedule, refer to the <MagicInfo Lite Server user's manual>.

— If a device is deleted from the list of devices approved by the server, the device will reboot to reset its settings.

Setting the current time

A schedule may not run if the time set on the device is different from the server's current time.

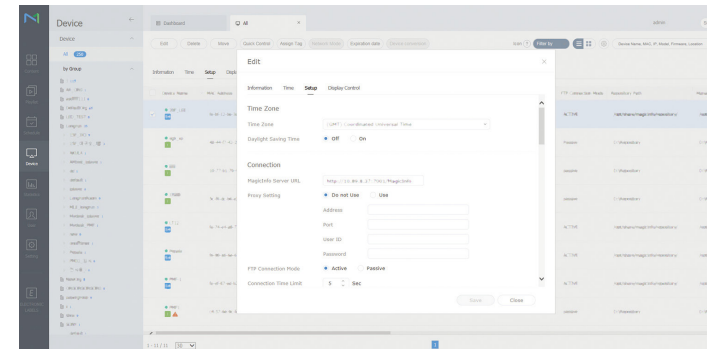

1 Select **Device** from the side menu bar.

2 Select your device.

3 Select **Edit** → **Setup**.

4 Select **Time Zone**.

— When connecting to the server for the first time, the time on the product is set using the GMT time of the region where the server is installed.

— The time on the product can be changed from the server as shown in step 3.

— Turning the product off and then on again will restore the time setting on the product to the last time that was set from the server.

— For further details on how to manage the time (scheduling, holiday management, etc.), refer to the <MagicInfo Lite Server user's manual>.

Chapter 06

Picture

Configure the **Picture** settings (**Contrast**, **Color Tone**, etc.).

The layout of the **Picture** menu options may vary depending on the product.

Picture	
Picture Mode	Shop & Mall
· Contrast	_____ 70
· Brightness	_____ 45
· Sharpness	_____ 65
· Color	_____ 50
· Tint (G/R)	G50 _____ R50
Color Temperature	10000K

– The displayed image may differ depending on the model.

Picture Mode

☰ MENU → **Picture** → **Picture Mode** → 

Select a picture mode (**Picture Mode**) suitable for the environment where the product will be used.

Video/Image mode improves the picture quality of the video device. **Text** mode improves the picture quality of the computer.

- **Shop & Mall**
Suitable for shopping malls.
 - Select either **Video/Image** or **Text** depending on the picture mode.
- **Office & School**
Suitable for offices and schools.
 - Select either **Video/Image** or **Text** depending on the picture mode.
- **Terminal & Station**
Suitable for bus terminals and train stations.
 - Select either **Video/Image** or **Text** depending on the picture mode.
- **Video Wall**
Suitable for environments where videowall display are used.
 - Select either **Video/Image** or **Text** depending on the picture mode.
- **Calibration**
In this mode, the brightness, color, gamma and uniformity settings customized using the color calibration program **Advanced Color Management** are applied.
 - To apply the **Calibration** mode properly, make sure you configure the picture quality settings, such as brightness, color, gamma and uniformity, using the color calibration program **Advanced Color Management**.
 - To download the **Advanced Color Management** program, visit www.samsung.com/displaysolutions.

Contrast / Brightness / Sharpness / Color / Tint (G/R)

☰ MENU → **Picture** → 

Your product has several options for adjusting picture quality.

- When you make changes to **Contrast, Brightness, Sharpness, Color** or **Tint (G/R)**, the OSD will be adjusted accordingly.
- You can adjust and store settings for each external device you have connected to an input on the product.
- Lowering picture brightness reduces power consumption.

Color Temperature

☰ MENU → **Picture** → **Color Temperature** → 

Adjust the color temperature (Red / Green / Blue). (Range: 2800K–10000K)

- Enabled when **Color Tone** is set to **Off**.
- If **Picture Mode** is set to **Calibration**, **Color Temperature** is disabled.

White Balance

☰ MENU → **Picture** → **White Balance** → 

2 Point

Adjust the color temperature for a more natural picture.

- **R-Offset / G-Offset / B-Offset**: Adjust each color's (red, green, blue) darkness.
- **R-Gain / G-Gain / B-Gain**: Adjust each color's (red, green, blue) brightness.
- **Reset**: Suitable for environments where videowall display are used.

10 Point

Controls the white balance in 10 point interval by adjusting the red, green, and blue brightness.

- **Off / On**

Interval: Select interval to adjust.

Red: Adjust the red level.

Green: Adjust the green level.

Blue: Adjust the blue level.

Reset: Suitable for environments where videowall display are used.

- Some external devices may not support this function.
- Enabled when **Picture Mode** is set to **Office & School (Video/Image)**.

Gamma

☰ MENU → Picture → Gamma → ↗

Adjust the primary color intensity.

— If **Picture Mode** is set to **Calibration**, **Gamma** is disabled.

Advanced Settings

☰ MENU → Picture → Advanced Settings → ↗

— If **Picture Mode** is set to **Calibration**, **Advanced Settings** is disabled.

Dynamic Contrast

Adjust the screen contrast.

- Off / Low / Medium / High

Black Tone

Select the black level to adjust the screen depth.

- Off / Dark / Darker / Darkest

Flesh Tone

Emphasize pink **Flesh Tone**.

— If **Picture Mode** is set to **Text**, **Flesh Tone** is disabled.

RGB Only Mode

Displays the **Red**, **Green** and **Blue** color for making fine adjustments to the hue and saturation.

- Off / Red / Green / Blue

— If **Picture Mode** is set to **Text**, **RGB Only Mode** is disabled.

Color Space

Adjusts the range and variety of colors (the color space) available to create images.

- Auto / Native / Custom

— To adjust **Color**, **Red**, **Green**, **Blue** and **Reset**, set **Color Space** to **Custom**.

HDMI UHD Color

Enable to optimize picture quality for HDMI UHD connection.

- HDMI1 (Off / On)
- HDMI2 (Off / On)
- Display Port (Off / On)

— When **HDMI UHD Color** is set to **On**, up to the 3840 x 2160 @ 60 Hz resolution is supported by the SNOW-1703U model. When **HDMI UHD Color** is set to **Off**, up to 1920 x 1080 @ 60 Hz resolution is supported.

LED Picture Size

☰ MENU → Picture → LED Picture Size → 

Choose size and aspect ratio picture displayed on screen.

- **Original:** Display images in the original picture quality.
- **Custom:** Changes the resolution to suit the user's preferences.

Resolution

Set the width and height of the LED display. (Max : 3840 x 2160)

HDMI UHD Color	Width x Height	
	Max	Min
Off	1920 x 1080	182 x 182
On	3840 x 2160	408 x 408

— Available only when LED Picture Size is set to Custom.

Fit to screen

Adjusts the picture position. When selected, the full program image will be displayed. No part of the image will be cut off.

- **Off / On**

— Available only when LED Picture Size is set to Custom.

LED HDR

☰ MENU → Picture → LED HDR → 

Set options to provide an optimal HDR effect.

When using multiple S-Boxes, if you set LED HDR to On, the images qualities of the S-box outputs may differ. To prevent this, set the sub functions of LED HDR to Off.

Inverse Tone Mapping

Make the dark elements of the image darker and the bright elements brighter to make the image as realistic as possible.

- **Off / On**

Dynamic Peaking

Enlarge the difference of instantaneous maximum/minimum luminance so that the bright parts can be expressed more clearly.

- **Off / On**

Color Mapping

Map the color of the specific source image to the color of the target image in order to convert it to the desired color.

- **Off / On**

Picture Options

☰ MENU → Picture → Picture Options → 

— If **Picture Mode** is set to **Calibration**, **Picture Options** is disabled.

Color Tone

If **Picture Mode** is set to **Text**

- **Off / Cool / Standard / Warm**

If **Picture Mode** is set to **Video/Image**

- **Off / Cool / Standard / Warm1 / Warm2**

— If **Picture Mode** is set to **Calibration**, **Color Tone** is disabled.

— Settings can be adjusted and stored for each external device connected to an input on the product.

Digital Clean View

Reduce picture noise to avoid distractions such as flickering.

- **Off / Auto**

— If **Picture Mode** is set to **Calibration**, **Digital Clean View** is disabled.

— Enabled when **Picture Mode** is set to **Video/Image**.

HDMI Black Level

Selects the black level on the screen to adjust the screen depth.

- **Normal / Low / Auto**

— Available only in **HDMI 1** and **HDMI 2** mode (AV Timing : 480p, 576p, 720p, 1080i, 1080p).

Film Mode

This mode is suitable to view movies.

Sets the product to automatically sense and process film signals from all sources and adjust the picture for optimum quality.

- **Off / Auto1 / Auto2**

— This option can be configured if the input source supports 480i, 576i or 1080i.

— This option is not supported when a PC is connected.

— Enabled when **Picture Mode** is set to **Video/Image**.

Reset Picture

☰ MENU → Picture → Reset Picture → 

Resets your current picture mode to its default settings.

Chapter 07

OnScreen Display

OnScreen Display	
Screen Protection	
Message Display	
Language	English
Menu Size	Original
Reset OnScreen Display	

– The displayed image may differ depending on the model.

Screen Protection

☰ MENU → OnScreen Display → Screen Protection → ↩

Auto Protection Time

If the screen displays a still image for a certain period of time you define, the product activates the screen saver to prevent the formation of burnt in ghost images on the screen.

- Off / 2 hours / 4 hours / 8 hours / 10 hours

Message Display

☰ MENU → OnScreen Display → Message Display → 

Source Info

Select whether to display the source OSD when the input source changes.

- Off / On

No Signal Message

Select whether to display the no-signal OSD when no signal is detected.

- Off / On

MDC Message

Select whether to display the MDC OSD when the product is controlled by the MDC.

- Off / On

Download Status Message

Select to display the status when downloading content from a server or other device.

- Off / On

Language

☰ MENU → OnScreen Display → Language → 

Set the menu language.

— A change to the language setting will only be applied to the onscreen menu display. It will not be applied to other functions on your PC.

Menu Size

☰ MENU → OnScreen Display → Menu Size → 

Set the aspect ratio of the menu to match the screen.

- Original / Medium / Small

Reset OnScreen Display

☰ MENU → OnScreen Display → Reset OnScreen Display → 

This option returns the current settings under **OnScreen Display** to the default factory settings.

Chapter 08

Network

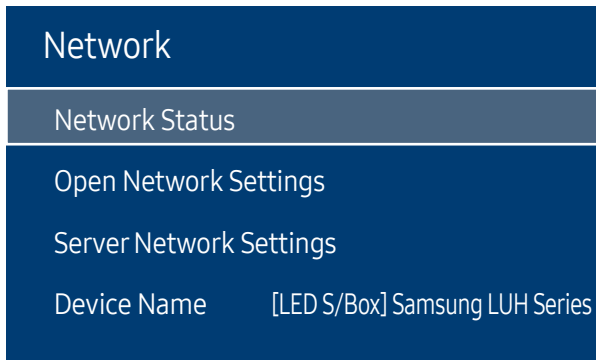

– The displayed image may differ depending on the model.

Network Status

☰ MENU → Network → Network Status → ↗

You can check the current network and Internet status.

Open Network Settings

☰ MENU → Network → Open Network Settings → ↗

Configure network settings to use various smart hub features such as Internet search, content sharing through a home network and feature updates.

Network Settings

Connecting to a Wired Network

There are three ways to attach your product to your LAN using cable.

- You can attach your product to your LAN by connecting the LAN port on the back of your product to an external modem using a LAN cable. See the diagram below.

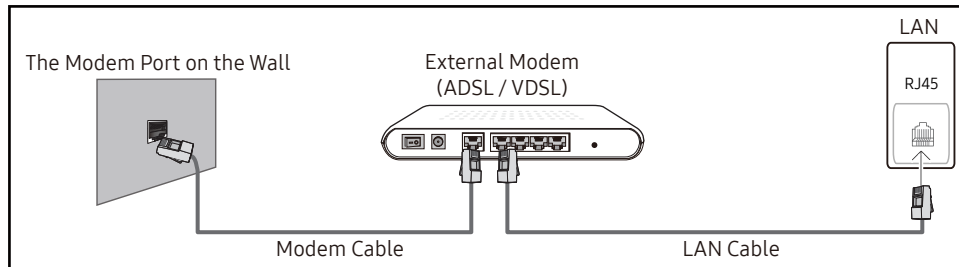

- You can attach your product to your LAN by connecting the LAN port on the back of your product to an IP Sharer which is connected to an external modem. Use LAN cable for the connection. See the diagram below.

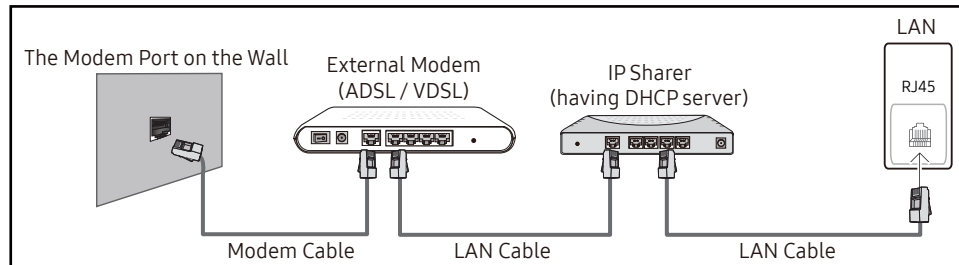

- Depending on how your network is configured, you may be able to attach your product to your LAN by connecting the LAN port on the back of your product directly to a network wall outlet using a LAN cable. See the diagram below. Note that the wall outlet is attached to a modem or router elsewhere in your house.

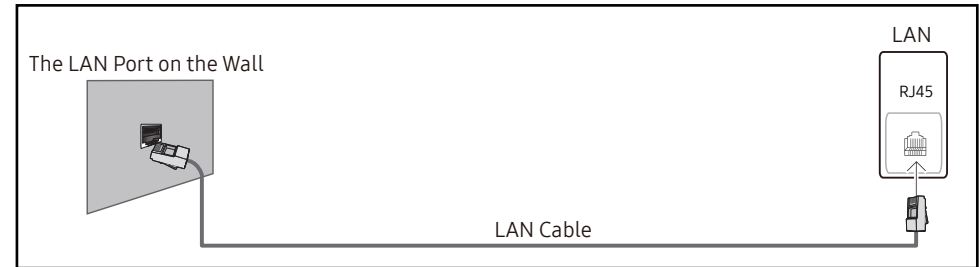

If you have a Dynamic Network, you should use an ADSL modem or router that supports the Dynamic Host Configuration Protocol (DHCP). Modems and routers that support DHCP automatically provide the IP address, subnet mask, gateway, and DNS values your product needs to access the Internet so you do not have to enter them manually. Most home networks are Dynamic Networks.

Some networks require a Static IP address. If your network requires a Static IP address, you must enter the IP address, subnet mask, gateway, and DNS values manually on your product Cable Setup Screen when you set up the network connection. To get the IP address, subnet mask, gateway, and DNS values, contact your Internet Service Provider (ISP).

If you have a Windows computer, you can also get these values through your computer.

- You can use ADSL modems that support DHCP if your network requires a Static IP address.
- ADSL modems that support DHCP also let you use Static IP addresses.
- A Static IP address is recommended. If the IP address is changed by DHCP, LED Signage Manager may be disconnected.

Set the network connection to use Internet services such as perform software upgrades.

Automatic Open Network Settings

Connect to the network using a LAN cable.
Make sure a LAN cable is connected first.

How to set up automatically

- 1 Select **Open Network Settings**. The **Open Network Settings** session starts.
- 2 The network test screen appears and verifies the network connection.

When the connection has been verified, the “**Your TV is connected to the Internet. If you have any problems using online services, please contact your internet service provider.**” message appears.
 - If the connection process fails, check the LAN port connection.
 - If the automatic process cannot find the network connection values or if you want to set the connection manually, go to the next section, network setup.

Manual Open Network Settings

Offices may use static IP addresses.

If this is the case, ask the network administrator for the IP address, subnet mask, gateway and DNS server address. Enter these values manually.

Getting the Network Connection Values

To view the Network connection values on most Windows computers, follow these steps.

- 1 Right click the Network icon on the bottom right of the screen.
- 2 In the pop-up menu that appears, click Status.
- 3 On the dialog that appears, click the **Support** tab.
- 4 On the **Support** Tab, click the **Details** button. The Network connection values are displayed.

How to set up manually

- 1 Select **Open Network Settings**. The **Open Network Settings** session starts.
- 2 The network test screen appears and the verification process starts. Press **Stop**. The verification process stops.
- 3 Select **IP Settings** on network connection screen. The **IP Settings** screen appears.
- 4 Select the field at the top, press , and then set **IP Settings** to **Enter manually**. Repeat the entry process for each field in the **IP Address**.
 - Setting **IP Settings** to **Enter manually** automatically changes **DNS Setting** to **Enter manually**.
- 5 When done, select **OK** at the bottom of the page, and then press . The network test screen appears and the verification process starts.
- 6 When the connection has been verified, the “**Your TV is connected to the Internet. If you have any problems using online services, please contact your internet service provider.**” message appears.

Server Network Settings

☰ MENU → Network → Server Network Settings → 

Connect to Server

To run **Player** connect to a network.

- **Server Address / SSL / Port**
- If the **SSL** option is enabled, the server is configured to use https and data transfer is encrypted.
- Enter the server IP address and port number. Use 7001 as the port number. (If unable to connect to the server using port number 7001, check with your server administrator to find the correct port number and then change the port number.)

MagicInfo Mode

Select the appropriate **MagicInfo Mode** depending on the environment where you are using the product.

- **Lite / Premium**

Server Access

Select a method to connect the server network.

- **Allow / Deny**

FTP Mode

Specify the FTP operating mode.

- **Active / Passive**

Proxy Server

Set up your proxy server connection and related functions.

Off / On

- **Address / Port / ID / Password**
- **Address / Port / ID** and **Password** are enabled only when **Proxy Server** is set to **On**.

Device Name

☰ MENU → Network → Device Name → 

Select or enter a device name.

This name can be shown on network remote controls over the network.

- **[LED S/Box] Samsung LUH Series1 ~ 6 / User Input**

Chapter 09

System

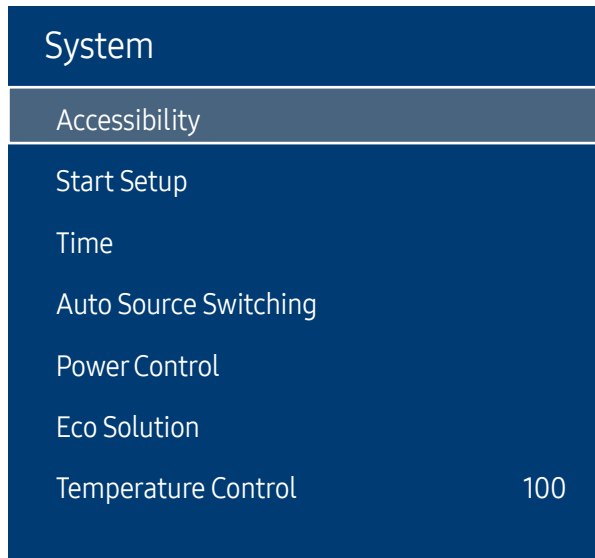

– The displayed image may differ depending on the model.

Accessibility

☰ MENU → System → Accessibility → ↗

Menu Transparency

Adjust transparency of menu box.

- High / Low

High Contrast

Set the background and font to high-contrast colors in Menu. Menu transparencies become opaque when the option is selected.

- Off / On

Enlarge

Set whether to enlarge highlighted item in Menu.

- Off / On

Start Setup

☰ MENU → System → Start Setup → 

Go through the initial setup steps like you did the first time you used this product.

- Enter your 4 digit PIN number. The default PIN number is "0-0-0-0".
If you want to change the PIN number, use the **Change PIN** function.

Time

☰ MENU → System → Time → 

You can configure **Clock Set** or **Sleep Timer**. You can also set the product to automatically turn on or off at a specified time using the **Timer** function.

- Press the INFO button if you want to view the current time.

Clock Set

Select **Clock Set**. Select **Date** or **Time**, and then press .

Use the number buttons to enter numbers or press the up and down arrow buttons. Use the left and right arrow buttons to move from one entry field to the next. Press  when done.

- You can set the **Date** and **Time** directly by pressing the number buttons on the remote control.

DST

Switches the DST (Daylight Saving Time) function on or off.

Off / On

- **Start Date**: Set the start date of Daylight Saving Time.
- **End Date**: Set the end date of Daylight Saving Time.
- **Time Offset**: Select the correct time offset your timezone.

- **Start Date**, **End Date** and **Time Offset** are enabled only when **DST** is set to **On**.

Sleep Timer

Automatically shuts off the product after a preset period of time.

(Off / 30 min. / 60 min. / 90 min. / 120 min. / 150 min. / 180 min.)

- Use the up and down arrows to select a period of time, and then press . To cancel **Sleep Timer**, select **Off**.

Power On Delay

When connecting multiple products, adjust the power-on time for each product to prevent power overload (within the range 0–50 seconds).

Auto Source Switching

☰ MENU → System → Auto Source Switching → 

Turning on the display with **Auto Source Switching On**, and the previous video source selection is not active, the display will automatically search the different video input sources for active video.

Auto Source Switching

When the **Auto Source Switching** is **On**, the display video source will automatically be searched for active video.

The **Primary Source** selection will be activated, if the current video source is not recognized.

Secondary Source selection will become active, if no primary video source is available.

If both the primary and secondary input sources are not recognized, the display will perform two searches for an active source, each search checking the primary and then secondary source. If both searches fail, the display will return to the first video source and display a message indicating that there is no signal.

When the **Primary Source** selection is set to **All**, the display will search all the video source inputs twice in sequence looking for an active video source, returning back to the first video source in the sequence if no video is found.

Primary Source Recovery

Select whether to restore the selected primary input source when a primary input source is connected.

- The **Primary Source Recovery** function is disabled if **Primary Source** is set to **All**.

Primary Source

Specify **Primary Source** for the automatic input source.

Secondary Source

Specify **Secondary Source** for the automatic input source.

- The **Secondary Source** function is disabled if **Primary Source** is set to **All**.

Power Control

☰ MENU → System → Power Control → ⏪

Auto Power On

This feature automatically turns on the product as soon as it is plugged in. Pressing the power button is not needed.

- Off / On

Max. Power Saving

Turns off the product to reduce power consumption after the PC has been left idle for a specified period of time.

- Off / On

Standby Control

You can set the screen standby mode to be applied when an input signal is received.

- **Auto**
Power-saving mode will activate if no input signals are detected even though a source device is connected to the display.
The message **No Signal** will appear if no source device is connected.
- **Off**
The message **No Signal** will appear if no input signals are detected.
 - If **No Signal** is displayed although a source device is connected, check the cable connection.
 - If **No Signal Message** is set to **Off**, the **No Signal** message does not appear. If this is the case, set **No Signal Message** to **On**.
- **On**
Power-saving mode will activate if no input signals are detected.

Network Standby

This feature keeps the network power on when the product turns off.

- Off / On

Power Button

The power button can be set to either turn on the power or turn on/off the power.

- **Power On Only**: Set the power button to turn on the power.
- **Power On/Off**: Set the power button to turn on/off the power.

Eco Solution

☰ MENU → System → Eco Solution → ⏪

No Signal Power Off

Save power by turning the device off when no signal is received from any source.

- Off / 15 min. / 30 min. / 60 min.
 - Disabled when an attached PC is in power saving mode.
 - The product will automatically power off at a specified time. The time can be changed as required.

Auto Power Off

The product will automatically turn off if you don't press a button on the remote or touch a button on product front panel within select hours to prevent overheating.

- Off / 4 hours / 6 hours / 8 hours

Temperature Control

☰ MENU → System → Temperature Control → ☞

This function detects the internal temperature of the product. You can specify the temperature range that is acceptable.

The default temperature is set to 100 °C.

The recommended operating temperature for this product is 95 to 100 °C (based on an ambient temperature of 40 °C).

— The screen will become darker if the current temperature exceeds the specified temperature limit. If the temperature continues to rise, the product will power off to prevent overheating.

Input Device Manager

☰ MENU → System → Input Device Manager → ☞

Configure options for external input devices connected to the product.

Keyboard Language

Configure the key combination used to change the input language.

Keyboard Type

Specify the keyboard type.

Input Language Shortcut

Select shortcut keys for switching between input languages.

Play via

☰ MENU → System → Play via → ☞

Select the appropriate **Play via** mode depending on the environment where you are using the product.

The home screen may be different depending on the setting.

- **MagicInfo / URL Launcher**

Change PIN

☰ MENU → System → Change PIN → ☞

The **Change PIN** screen will appear.

Choose any 4 digits for your PIN and enter it in **Enter New PIN**. Reenter the same 4 digits in **Confirm New PIN**.

The product has memorized your new PIN.

— Default password: 0 - 0 - 0 - 0

Security

☰ MENU → System → Security → 

- Enter your 4 digit PIN number. The default PIN number is "0-0-0-0".
If you want to change the PIN number, use the **Change PIN** function.

Safety Lock On

All the menus and buttons of the product and remote control, except for the Power button on the remote control, will be locked by the **Safety Lock On** function.

To unlock the menus and buttons, press any button and then enter the password (default password: 0-0-0-0).

Turn on **Power On Button** to enable the remote control's Power button to turn on the device while **Safety Lock On** is enabled.

Power On Button

Turn on this feature to enable the remote control's Power button to turn on the device while **Safety Lock On** is enabled.

- Off / On

Button Lock

This menu can be used to lock the buttons on the product.

Only the remote control can control the product if **Button Lock** is set to **On**.

- Off / On

USB Auto Play Lock

Select whether to automatically play **MagicInfo** content saved on a connected USB device.

- **Off**
Play **MagicInfo** content saved on the USB device automatically.
- **On**
Do not play **MagicInfo** content saved on the USB device automatically.
 - Connecting a USB device containing **MagicInfo** content displays "**USB Auto Play Lock : On**" for five seconds.

Remote Management

You can **Allow** or **Deny** external commands to access your device via a network.

The changed setting remains even after the product is turned off and on using the Panel key or Power switch.

- Deny / Allow

General

☰ MENU → System → General → ↩

Smart Security

Security provided to protect your TV and connected storage devices against viruses includes.

Scan

Inspect the TV and connected storage devices to check for viruses.

Isolated List

This is the list of items that have been Isolated for containing viruses.

Real-Time Monitoring

Scans for viruses by monitoring the display device in real time.

Monitoring Results

Check the list of files, networks, and processes that have been blocked.

Anynet+ (HDMI-CEC)

Anynet+ (HDMI-CEC)

Anynet+ is a function that enables you to control all connected Samsung devices that support Anynet+ with your Samsung product remote. The Anynet+ system can be used only with Samsung devices that have the Anynet+ feature. To be sure your Samsung device has this feature, check if there is an Anynet+ logo on it.

- **Off / On**

- You can only control **Anynet+** devices using the product remote control, not the buttons on the product.
- The product remote control may not work under certain conditions. If this occurs, reselect the **Anynet+** device.
- **Anynet+** works when the AV device supporting **Anynet+** is in the standby or on status.
- **Anynet+** supports up to 12 AV devices in total. Note that you can connect up to 3 devices of the same type.

Troubleshooting for Anynet+

Problem	Possible Solution
Anynet+ does not work.	<ul style="list-style-type: none">• Check if the device is an Anynet+ device. The Anynet+ system supports Anynet+ devices only.• Check if the Anynet+ device power cord is properly connected.• Check the Anynet+ device's Video/HDMI cable connections.• Check whether Anynet+ (HDMI-CEC) is set to On in the System menu.• Check whether the remote control is Anynet+ compatible.• Anynet+ doesn't work in certain situations. (initial setup)• If you have removed and then reconnected the HDMI cable, please make sure to search devices again or turn your product off and on again.• Check if the Anynet+ function of the Anynet device is set on.
I want to start Anynet+.	<ul style="list-style-type: none">• Check if the Anynet+ device is properly connected to the product and check if the Anynet+ (HDMI-CEC) is set to On in the System menu.
I want to exit Anynet+.	<ul style="list-style-type: none">• Press the SOURCE button on the product remote control and select a non- Anynet+ device.
The message " Disconnecting Anynet+ device ... " appears on the screen.	<ul style="list-style-type: none">• You cannot use the remote control when you are configuring Anynet+ or switching to a view mode.• Use the remote control after the product has completed Anynet+ configuration or has finished switching to Anynet+.
The Anynet+ device does not play.	<ul style="list-style-type: none">• You cannot use the play function when initial setup is in progress.

Problem

Possible Solution

The connected device is not displayed.	<ul style="list-style-type: none">• Check whether or not the device supports Anynet+ functions.• Check whether or not the HDMI cable is properly connected.• Check whether Anynet+ (HDMI-CEC) is set to On in the System menu.• Search Anynet+ devices again.• Anynet+ requires an HDMI connection. Make sure the device is connected to your product with an HDMI cable.• Some HDMI cables may not support Anynet+ functions.• If the connection is terminated because there has been a power failure or the HDMI cable has been disconnected, please repeat the device scan.
--	---

Custom Logo

You can download, select, and set the display time of a custom logo that appears when the product turns on.

- **Custom Logo**
 - You can select a custom logo (image/video) or turn off the custom logo display.
 - You must download the custom logo from an external USB device to set the custom logo.
- **Logo Display Time**
 - If the type of custom logo is **Image**, you can set the **Logo Display Time**.
- **Download Logo File**
 - You can download a custom logo into the product from an external USB device.
 - The file name of the custom logo you want to download must be saved as “samsung” in all small letters.
 - When there are multiple numbers of external USB connections, the product will attempt to download the custom logo from the last device that has been connected to the product.

Custom logo file restrictions

- For image type custom logo, only bitmap files (aRGB 32bpp format) are supported.
- The resolution of the image type custom logo must be between a minimum of 64x64 and the maximum screen resolution. (Horizontal/Vertical values of the resolution must be multiples of 4.)
- For video type custom logo, only TS Stream types are supported.
- The maximum supported video file is 150 MB. The recommended length of a video file is 20 seconds or less.

Game Mode

When connecting to a game console such as PlayStation™ or Xbox™, you can enjoy a more realistic gaming experience by selecting game mode.

- **Off / On**
 - Precautions and limitations for **Game Mode**
 - To disconnect the game console and connect another external device, set **Game Mode** to **Off** in the setup menu.

Reset System

☰ MENU → **System** → **Reset System** → 

This option returns the current settings under system to the default factory settings.

Chapter 10

Support

Software Update

☰ MENU → Support → Software Update → 

The **Software Update** menu lets you upgrade your product software to the latest version.

- Be careful not to turn off the power until the upgrade is complete. The product will turn off and on automatically after completing the software upgrade.
- When you upgrade software, all video settings you have made will return to their default settings. We advise you to write down your settings so that you can easily reset them after the upgrade.

Update Now

Update the software to the latest version.

Auto Update

This feature automatically updates the product when not in use.

- **Off / On**

Contact Samsung

☰ MENU → Support → Contact Samsung → 

View this information when your product does not work properly or when you want to upgrade the software.

You can find information regarding our call centers and how to download products and software.

- **Contact Samsung** and find the product **Model Code** and **Software Version**.

Reset All

☰ MENU → Support → Reset All → 

This option returns all the current settings for a display to the default factory settings.

Chapter 11

Playing photos and videos (Media Play)

Enjoy videos, photos files saved on a USB Mass Storage Class (MSC) device.

Play photos or videos saved on a storage device.

Play a variety of content using the following methods.

- Using a USB device: Play media content such as videos and photos from a USB device.
- Connecting a storage device: Play media content saved on a storage device such as a smartphone, camera, PC or cloud service.

Read the following before using media play with a USB device

Caution

- Before connecting a USB device to the product, back up files to ensure your data is not damaged or lost. Samsung Electronics is not liable for any damage or loss of data.
- Do not remove a USB device while it is loading.
- If a USB device is connected using a USB extension cable, the USB device may not be recognized or files saved on the device may not be able to be read.
- If the product does not recognize a connected USB device, the files on the USB device may be corrupted or may not be able to be played. If this occurs, connect the USB device to the PC to format the device, then make sure the device is connected properly.
- USB HDD greater than 2TB is not supported.

Compatible devices with media play

- Some USB digital cameras and smartphones may not be compatible with the product.
- Media play is only compatible with USB MSC devices.
- MSC device refers to a Mass Storage Class Bulk-Only Transport device.
Examples of MSC devices include Thumb drives, Flash card readers and USB HDDs. (USB hubs are not supported.)
These MSC devices must be connected directly to a USB port on the product.
- If more than one Picture Transfer Protocol (PTP) device is connected, only one will work at a time.
- If multiple MSC devices are connected, some devices may not be recognized.
- USB devices that require high power (higher than 500mA or 5V) may not be supported.
- If an overheating warning message appears when a USB device is connected or used, the USB device may not be recognized or function properly.
- The screensaver activates if the product is left idle for a period of time specified in **Auto Protection Time**.
- Power-saving mode on some external hard disk drives may automatically deactivate after connecting to the product.

File system and formats

- Media play may not function properly with unlicensed multimedia files.
- Media Transfer Protocol (MTP) is not supported.
- Supported file systems include FAT16, FAT32 and NTFS (read only).
- Media play supports the sequential JPEG format.
It does not support the progressive JPEG format.
- Images with a higher resolution take longer to be displayed on the screen.
- The maximum JPEG resolution supported is 15360x8640 pixels.
- If a file is incompatible or corrupted, a message **Not Supported File Format** appears.
- When sorting files in folder view mode, a maximum of 1000 files can be displayed in each folder.
- If a USB device contains 8000 files and folders or more, some files and folders may not open.
- DRM MP3 files downloaded from websites that charge a fee cannot be played.
Digital Rights Management (DRM) refers to a system for protecting the copyrights of data circulated via the Internet or other digital media by enabling secure distribution and/or disabling illegal distribution of the data.

Using a USB device



Connecting a USB device

- 1 Turn on your product.
- 2 Connect a USB device containing photo and/or movie files to the USB port on the back or side panel of the product.
- 3 The **Player** page automatically appears as soon as a USB device connects to the product.
 - If only one USB device is connected, files saved on the USB device are displayed automatically.
 - To view content saved on a USB device, connect the USB device to a USB port on the product.

– It is recommended to use a USB HDD that has a power adapter.

Removing a USB device

Removing a USB device from Source

- 1 Press  on the remote control.
 -  → **Player** → **Options** → **Safely Remove**
- 2 Select **Safely Remove** and wait until the USB device is disconnected. The USB device is disconnected.

– It is recommended to remove a USB device using the **Safely Remove** function.

Features provided in the media content list page

🏠 → **Player** → Storage device → **USB**

The media content list page on a storage device provides the following features.

- Storage device
Internal Memory / USB
- **Filter By**
Among **Video**, **Image**, **PDF**, **Office** and **My Templates** content saved on a storage device, view content files under a desired file format only.
- **Options**

Menu items in the media content list page

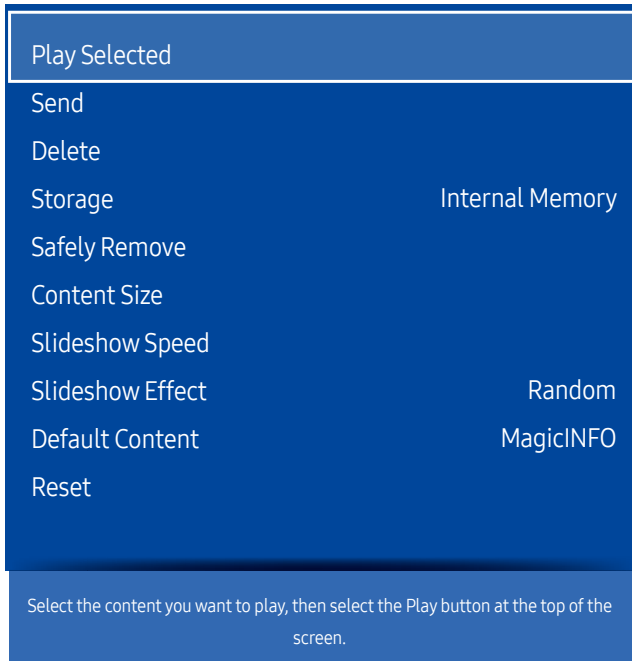

– The displayed image may differ depending on the model.

Option Name	Operations
Play Selected	Select the content you want to play, then select the play button at the top of the screen.
Send	Select the content you want to send to the other device, then select the Send button at the top of the screen.
Delete	Select the content you want to delete, then select the Delete button at the top of the screen.
Storage	Select the save location for schedules downloaded from the magicInfo server and other devices.
Safely Remove	Safely removes USB memory
Content Size	Set the screen size for content.
Slideshow Speed	Set the time each slide will play for.
Slideshow Effect	Set which transition effect to apply between image slides.
Default Content	This default content will be displayed if you run a channel while no programs are scheduled on the channel.
Reset	Restore all the values under Options to the default when the product was purchased.

-
- Pressing the INFO button while a device name is selected will display information about the selected device.
 - Pressing the INFO button while a file is selected will display information about the selected file.





Available buttons and features during photo playback

Pressing the  button or , , ,  button displays the following buttons. The RETURN button makes the buttons disappear.

- Pause / Play
Start or stop a slideshow. Using a slideshow, it is possible to play all photos in a folder.
- Previous / Next
View the previous or next photo.

Available buttons and features during video playback

Pressing the  button or , , ,  button displays the following buttons. The RETURN button makes the buttons disappear.

- Pause / Play
Pause or play a video.
The following features are available in pause mode.
- Rewind / Fast forward
Rewind or fast forward a video. Speed up playback up to 3x, if required. To change the playback speed to the original speed, select .
- Previous / Next
To play the previous video, select  twice. Selecting  once will play the current video from the beginning.
To play the next video, select .

Chapter 12

Troubleshooting Guide

Before calling Samsung Customer Service Center, test your product as follows. If the problem persists, contact Samsung Customer Service Center.

If the screen remains blank, check the PC system, video controller and cable.

Requirements Before Contacting Samsung Customer Service Center

Testing the Product

Check if your product is operating normally by using the product test function.

If the screen remains blank while the power LED blinks even when the product is correctly connected to a PC, perform product testing.

- 1 Power off both the PC and product.
- 2 Disconnect all the cables from the product.
- 3 Power on the product.
- 4 If **No Signal** is displayed, the product is operating normally.

Checking the Resolution and Frequency

Not Optimum Mode will briefly be displayed if a mode that exceeds a supported resolution is selected (refer to Supported Resolutions).

Check the followings.

Installation issue (PC mode)

The screen keeps switching on and off.	Check the cable connection between the product and PC, and ensure the connection is secure.
Blank spaces are found on all four sides of the screen when a DP, an HDMI, or an HDMI-DVI cable is connected between the product and PC.	<p>The blank spaces found on the screen have nothing to do with the product.</p> <p>Blank spaces on the screen are caused by the PC or graphics card. To resolve the problem, adjust the screen size in the HDMI or DVI settings for the graphics card.</p> <p>If the graphics card settings menu does not have an option to adjust the screen size, update the graphics card driver to the latest version.</p> <p>(Please contact the graphics card or computer manufacturer for further details about how to adjust the screen settings.)</p>

Screen issue

The power LED is off. The screen will not switch on.	Make sure that the power cord is connected.
No Signal is displayed on the screen.	<p>Check that the product is connected correctly with a cable.</p> <p>Check that the device connected to the product is powered on.</p>
Not Optimum Mode is displayed.	<p>This message is displayed when a signal from the graphics card exceeds the product's maximum resolution and frequency.</p> <p>Refer to the Standard Signal Mode Table and set the maximum resolution and frequency according to the product specifications.</p>
The images on the screen look distorted.	Check the cable connection to the product.
The screen is not clear. The screen is blurry.	Set the resolution and frequency to the recommended level.

Screen issue

The screen appears unstable and shaky.	Check that the resolution and frequency of the PC and graphics card are set within a range compatible with the product. Then, change the screen settings if required by referring to the Additional Information on the product menu and the Standard Signal Mode Table.
There are shadows or ghost images left on the screen.	
The screen is too bright. The screen is too dark.	Adjust Brightness and Contrast .
Screen color is inconsistent.	Go to Picture and adjust the Color Space settings.
White does not really look white.	Go to Picture and adjust the White Balance settings.
There is no image on the screen and the power LED blinks every 0.5 to 1 second.	The product is in power-saving mode. Press any key on the keyboard or move the mouse to return to the previous screen.
The product will turn off automatically.	Go to System and make sure Sleep Timer is set to Off . If a PC is connected to the product, check the power status of the PC. Make sure the power cable is connected properly to the product and power outlet. If the signal from a connected device is not detected, the product automatically turns off after 10 to 15 minutes.
Picture quality of the product is different from the dealer shop where it was purchased.	Use an HDMI cable to obtain high-definition (HD) picture quality.
The screen display does not look normal.	Encoded video content may cause the display to appear corrupted in scenes featuring fast moving objects such as in a sports event or action video. Low signal level or low picture quality may cause the display to appear corrupted. This does not mean the product is defective. A cell phone within a distance of one-meter radius may cause static on analog and digital products.

Screen issue

The brightness and color do not look normal.

Go to **Picture** and adjust the screen settings such as **Picture Mode, Color, Brightness** and **Sharpness**.

Reset the screen settings to the default settings.

Lines (red, green or blue) are displayed on the screen.

These lines are displayed when there is a defect in DATA SOURCE DRIVER IC on the monitor. Contact a Samsung Service Center to resolve the issue.

The display looks unstable and then freezes.

The screen may freeze when a resolution other than the recommended resolution is used or if the signal is not stable. To resolve the issue, change the PC resolution to the recommended resolution.

The screen cannot be displayed in full screen.

A scaled SD (4:3) content file can cause black bars on both sides of an HD channel screen.

A video with an aspect ratio different from the product can cause black bars at the top and bottom of the screen.

Change the screen size setting to full screen on the product or source device.

Remote control issue

The remote control does not work.

Make sure that the batteries are correctly in place (+/-).

Check if the batteries are flat.

Check for power failure.

Make sure that the power cord is connected.

Check for any special lighting or neon signs switched on in the vicinity.

Source device issue

A beeping sound is heard when my PC is booting.

If a beeping sound is heard when your PC is booting, have your PC serviced.

Other issue

The product smells like plastic.

The plastic smell is normal and disappears over time.

Video playback is choppy.

Check the cable connection and connect it again if required.

Using an excessively hard or thick cable may cause choppy video playback.

Make sure cables are flexible enough to ensure durability. When mounting the product onto a wall, it is recommended to use right-angle cables.

Small particles are found on the edges of the product.

The particles are part of the product design. The product is not defective.

When I try to change the PC resolution, a message "**The defined resolution is not currently supported.**" appears.

The message "**The defined resolution is not currently supported.**" appears if the input source resolution exceeds the maximum resolution of the display.

To resolve the issue, change the PC resolution to a resolution supported on the display.

HDMI Black Level is not functioning properly on an HDMI device with YCbCr output.

This function is available only when a source device, such as a DVD player and STB, is connected to the product via an HDMI (RGB signal) cable.

Other issue

The IR sensor is not functioning.

Make sure the sensor light turns on when a button is pressed on the remote control.

- If the light does not turn on, turn the power switch off and then on again. If the sensor light still does not turn on after the power switch is turned off and then on again, an internal jack may be disconnected. Contact your nearest service center to have the product serviced.

In power-saving mode, when the input source is **DisplayPort**, PC display settings cannot be saved.

Go to **System** → **Power Control** and set **Max. Power Saving** to **Off**. Alternatively, configure the PC display output settings again. Ensure the set is turned on.

When booting the PC with the input source set to **DisplayPort**, the BIOS and booting screens do not appear.

Boot the PC when the set is turned on or when the input source is not **DisplayPort**.

Q & A

Question

How can I change the frequency?

– Refer to the user manual for your PC or graphics card for further instructions on adjustment.

Answer

Set the frequency on your graphics card.

- Windows XP: Go to **Control Panel** → **Appearance and Themes** → **Display** → **Settings** → **Advanced** → **Monitor** and adjust the frequency in **Monitor Settings**.
- Windows ME/2000: Go to **Control Panel** → **Display** → **Settings** → **Advanced** → **Monitor** and adjust the frequency in **Monitor Settings**.
- Windows Vista: Go to **Control Panel** → **Appearance and Personalization** → **Personalize** → **Display Settings** → **Advanced Settings** → **Monitor** and adjust the frequency in **Monitor Settings**.
- Windows 7: Go to **Control Panel** → **Appearance and Personalization** → **Display** → **Adjust resolution** → **Advanced Settings** → **Monitor** and adjust the frequency in **Monitor Settings**.
- Windows 8: Go to **Settings** → **Control Panel** → **Appearance and Personalization** → **Display** → **Adjust resolution** → **Advanced Settings** → **Monitor** and adjust the frequency in **Monitor Settings**.
- Windows 10: Go to **Settings** → **System** → **Display** → **Advanced display settings** → **Display adapter properties** → **Monitor**, and adjust **Screen refresh rate** under **Monitor settings**.

How can I change the resolution?

- Windows XP: Go to **Control Panel** → **Appearance and Themes** → **Display** → **Settings** and adjust the resolution.
 - Windows ME/2000: Go to **Control Panel** → **Display** → **Settings** and adjust the resolution.
 - Windows Vista: Go to **Control Panel** → **Appearance and Personalization** → **Personalize** → **Display Settings** and adjust the resolution.
 - Windows 7: Go to **Control Panel** → **Appearance and Personalization** → **Display** → **Adjust Resolution** and adjust the resolution.
 - Windows 8: Go to **Settings** → **Control Panel** → **Appearance and Personalization** → **Display** → **Adjust Resolution** and adjust the resolution.
 - Windows 10: Go to **Settings** → **System** → **Display** → **Advanced display settings**, and adjust the resolution.
-

Question

How do I set powersaving mode?

Answer

- Windows XP: Set power-saving mode in **Control Panel** → **Appearance and Themes** → **Display** → **Screen Saver Settings** or BIOS SETUP on the PC.
 - Windows ME/2000: Set power-saving mode in **Control Panel** → **Display** → **Screen Saver Settings** or BIOS SETUP on the PC.
 - Windows Vista: Set power-saving mode in **Control Panel** → **Appearance and Personalization** → **Personalize** → **Screen Saver Settings** or BIOS SETUP on the PC.
 - Windows 7: Set power-saving mode in **Control Panel** → **Appearance and Personalization** → **Personalize** → **Screen Saver Settings** or BIOS SETUP on the PC.
 - Windows 8: Set power-saving mode in **Settings** → **Control Panel** → **Appearance and Personalization** → **Personalize** → **Screen Saver Settings** or BIOS SETUP on the PC.
 - Windows 10: Set power-saving mode in **Settings** → **Personalization** → **Lock screen** → **Screen timeout settings** → **Power & sleep** or BIOS SETUP on the PC.
-

Chapter 13

Specifications

General

Model Name	SNOW-1703U	
Power Supply	AC 100 to 240 VAC (+/- 10%), 60 / 50 Hz ± 3 Hz Refer to the label at the back of the product as the standard voltage can vary in different countries.	
Environmental considerations	Operating	Temperature : 50 °F - 104 °F (10 °C - 40 °C) Humidity : 10% - 80%, non-condensing
	Storage	Temperature : -4 °F - 113 °F (-20 °C - 45 °C) Humidity : 5% - 95%, non-condensing
Supported models	IF015H, IF020H, IF025H	

Model Name		IF015H	IF020H	IF025H
Cabinet	Pixel Pitch	1.5 mm / 0.06 inches	2.0 mm / 0.08 inches	2.5 mm / 0.1 inches
	LED pixel configuration	3-in-1(R/G/B in 1 LED)	3-in-1(R/G/B in 1 LED)	3-in-1(R/G/B in 1 LED)
	LED pixel size (W x H)	1.0 mm x 1.0 mm 0.04 inches x 0.04 inches	1.5 mm x 1.5 mm 0.06 inches x 0.06 inches	2.1 mm x 2.1 mm 0.08 inches x 0.08 inches
	Pixels (Row x Column)	320 x 360 pixels	240 x 270 pixels	192 x 216 pixels
	Aspect ratio (W:H)	8:9	8:9	8:9
Power Supply	Line input voltage range	AC 100 to 240 VAC (+/- 10%)		
	Line input freq. range	60 / 50 Hz ± 3 Hz		
Environmental considerations	Operating	Temperature : 32 °F - 104 °F (0 °C - 40 °C) Humidity : 10% - 80%, non-condensing		
	Storage	Temperature : -4 °F - 113 °F (-20 °C - 45 °C) Humidity : 5% - 95%, non-condensing		

Plug-and-Play

This monitor can be installed and used with any Plug-and-Play compatible systems. Two-way data exchange between the monitor and PC system optimizes the monitor settings. Monitor installation takes place automatically. However, you can customize the installation settings if desired.

This is a class A product. In a domestic environment this product may cause radio interference in which case the user may be required to take adequate measures.

For detailed device specifications, visit the Samsung Electronics website.

(USA only)

Dispose unwanted electronics through an approved recycler.

To find the nearest recycling location, go to our website: www.samsung.com/recyclingdirect or call, (877) 278 - 0799

Preset Timing Modes

- This product can be set to only one resolution for each screen size to obtain the optimum picture quality due to the nature of the panel. Using a resolution other than the specified resolution may degrade the picture quality. To avoid this, it is recommended that you select the optimum resolution specified for your product.
- When **HDMI UHD Color** is set to **On**, up to the 3840 x 2160 @ 60 Hz resolution is supported by the SNOW-1703U model. When **HDMI UHD Color** is set to **Off**, up to 1920 x 1080 @ 60 Hz resolution is supported.

Model Name		SNOW-1703U	IF015H / IF020H / IF025H
Synchronization	Horizontal Frequency	30 – 135 kHz	-
	Vertical Frequency	30 – 75 Hz (DP), 24 – 75 Hz (HDMI)	-
	Refresh rate	-	1920 - 3840 Hz
	Video Frame rate	-	50/60 Hz
Resolution	Optimum Resolution	1920 x 1080 @ 60 Hz, 3840 x 2160 @ 60 Hz	-
	Maximum Resolution	1920 x 1080 @ 60 Hz, 3840 x 2160 @ 60 Hz	-

The screen will automatically be adjusted if a signal that belongs to the following standard signal modes is transmitted from your PC. If the signal transmitted from the PC does not belong to the standard signal modes, the screen may be blank with the power LED on. In such a case, change the settings according to the following table by referring to the graphics card user manual.

Resolution	Horizontal Frequency (kHz)	Vertical Frequency (Hz)	Pixel Clock (MHz)	Sync Polarity (H/V)	S-Box Grouping Supported
IBM, 720 x 400	31.469	70.087	28.322	-/+	-
MAC, 640 x 480	35.000	66.667	30.240	-/-	-
MAC, 832 x 624	49.726	74.551	57.284	-/-	-
MAC, 1152 x 870	68.681	75.062	100.000	-/-	-
VESA, 640 x 480	31.469	59.940	25.175	-/-	-

– Horizontal Frequency

The time required to scan a single line from the left to the right side of the screen is called a horizontal cycle. The reciprocal number of a horizontal cycle is called horizontal frequency. Horizontal frequency is measured in kHz.

– Vertical Frequency

The product displays a single image multiple times per second (like a fluorescent light) to display what the viewer sees. The rate of a single image being displayed repeatedly per second is called vertical frequency or refresh rate. Vertical frequency is measured in Hz.

Resolution	Horizontal Frequency (kHz)	Vertical Frequency (Hz)	Pixel Clock (MHz)	Sync Polarity (H/V)	S-Box Grouping Supported
VESA, 640 x 480	37.861	72.809	31.500	-/-	-
VESA, 640 x 480	37.500	75.000	31.500	-/-	-
VESA, 800 x 600	35.156	56.250	36.000	+/+	-
VESA, 800 x 600	37.879	60.317	40.000	+/+	-
VESA, 800 x 600	48.077	72.188	50.000	+/+	-
VESA, 800 x 600	46.875	75.000	49.500	+/+	-
VESA, 1024 x 768	48.363	60.004	65.000	-/-	0
VESA, 1024 x 768	56.476	70.069	75.000	-/-	-
VESA, 1024 x 768	60.023	75.029	78.750	+/+	-
VESA, 1152 x 864	67.500	75.000	108.000	+/+	-
VESA, 1280 x 720	45.000	60.000	74.250	+/+	-
VESA, 1280 x 800	49.702	59.810	83.500	-/+	-
VESA, 1280 x 1024	63.981	60.020	108.000	+/+	0
VESA, 1280 x 1024	79.976	75.025	135.000	+/+	-
VESA, 1366 x 768	47.712	59.790	85.500	+/+	-
VESA, 1440 x 900	55.935	59.887	106.500	-/+	-
VESA, 1600 x 900	60.000	60.000	108.000	+/+	0
VESA, 1680 x 1050	65.290	59.954	146.250	-/+	-
VESA, 1920 x 1080	67.500	60.000	148.500	+/+	0
VESA, 3840 x 2160	67.500	30.000	297.000	+/+	-
VESA, 3840 x 2160	135.000	60.000	594.000	+/+	0

Chapter 14

Appendix

Responsibility for the Pay Service (Cost to Customers)

— When the service is requested, in spite of in warranty, we may charge you for a visit from a service technician in the following cases.

Not a product defect

Cleaning of the product, Adjustment, Explanation, Re-installation and etc.

- If a service technician gives instructions on how to use product or simply adjusts options without disassembling product.
- If a defect is caused by external environmental factors (Internet, Antenna, Wired Signal, etc.)
- If a product is reinstalled or devices are connected additionally after installing the purchased product for the first time.
- If a product is reinstalled to move to a different spot or to move to a different house.
- If customer requests instructions on how to use because of another company's product.
- If customer requests instructions on how to use the network or another company's program.
- If customer requests software installation and setup for the product.
- If a service technician removes/cleans dusts or foreign materials inside of the product.
- If customer requests an installation additionally after purchasing a product through home-shopping or online.

A Product damage caused by customer's fault

Product damage caused by customer's mishandling or wrong repair

If a product damage is caused by;

- External impact or drop.
- Use of supplies or separately sold product unspecified by Samsung.
- Repair from a person besides an engineer of outsourcing service company or partner of Samsung Electronics Co., Ltd.
- Remodeling or repairing the product by customer.
- Using it with incorrect voltage or non-authorized electrical connections.
- Not following the "cautions" in User Manual.

Others

- If product fails by natural disaster. (lightning, fire, earthquake, flood damage, etc)
 - If consumable components are all used up. (Battery, Toner, Fluorescent lights, Head, Vibrator, Lamp, Filter, Ribbon, etc.)
- If customer requests a service in case the product has no defect, service fee may be charged. So please read User Manual first.

License



The terms HDMI and HDMI High-Definition Multimedia Interface, and the HDMI Logo are trademarks or registered trademarks of HDMI Licensing LLC in the United States and other countries.

Open Source Licence Notice

In the case of using open source software, Open Source Licences are available on the product menu. Open Source Licence Notice is written only English.

For information on the Open Source Licence Notice, contact the Samsung Customer Center or send email to oss.request@samsung.com.

Open Source Announcement

Some software components of this product incorporate source code covered under the GNU General Public License (GPL), the GNU Lesser General Public License (LGPL) etc.

Acknowledgement:

The software included in this product contains copyrighted software that is licensed under the GPL/LGPL etc. You may obtain the complete Corresponding Source code from us for a period of three years after our last shipment of this product by sending email to: oss.request@samsung.com

If you want to obtain the complete Corresponding Source code in the physical medium such as CD-ROM, the cost of physically performing source distribution may be charged.

You may also find a copy of the source at following website.

http://software-dl.ti.com/processor-sdk-linux/esd/AM335X/latest/exports/software_manifest.htm
